

**MAKING YOUR
EFFORTS SIMPLY
THAT BIT BETTER.**

MAKING. ORDERING. SIMPLE.

Regardless of whether you want to order from your personal contact in the office, need a professional from the field service on site, or have a technical question – we're here to help! And to turn your challenges into your solution. Because that's our understanding of customer service here at RIEGLER.

We only stop working once the solution is perfect. Some say we just can't help it. We say that's exactly the way it should be.

We look forward to receiving your order – and we're ready to get working for you.



YOUR DIRECT LINE TO US.

info@riegler.de

ALL PHONE NUMBERS AT A GLANCE.

Order processing until 5:00 p.m. +49 7125 9497 - 8320

Technical advice +49 7125 9497 - 642

RIEGLER head office +49 7125 9497 - 0

OTHER CHANNELS YOU CAN USE TO REACH US.

Website www.riegler.de

Online-Shop www.riegler.shop

YOUR WAYS TO ORDER:



Online store



Email



Phone

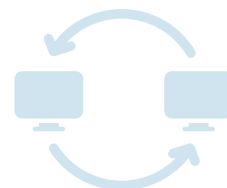

EDI

IMPRINT All the details in this catalogue are subject to change. We retain the right to make amendments of any kind without notification. Produced by: RIEGLER & Co. KG / Text, concept, and design: Beaufort 8 Werbeagentur, RIEGLER & Co. KG / Printing: logo Print GmbH **COPYRIGHT** All texts and images published in this catalog are protected by copyright. This applies equally for any image, sound, sketch, or design materials. This also applies with regard to databases and similar set-ups. No part of this catalogue may be duplicated, disseminated, reproduced, or made accessible publicly, incorporated into databases, stored on electronic data storage devices, or otherwise electronically duplicated, disseminated, or utilized outside the limitations of copyright protection law in any form without written permission from RIEGLER & Co. KG. **CLIMATE NEUTRALITY** This printed product is climate-neutral.



YOUR GOAL IS OUR GOAL. WE CALL THAT WORKING AS PARTNERS.

We never stand still, since we are always working on better solutions. That's why we are always focused on one goal: your goal. Because one can simply do a job – or one can carefully fulfill customers' wishes.

With this in mind, we have made some improvements: The first was to structure our 30,000 products in a newly developed product line structure. The result is that you can now see the five product classes – EASY, PLUS, MAX, FLEX, and YOU – at a glance; find out more on page X. You can now navigate through the pages more quickly, grasp the products better, and handle your day-to-day business more easily.

Secondly, we have upgraded with an even wider range of products: In the main catalogue you will find the most important products as well as numerous new additions –

the complementary range and the full RIEGLER variety can be seen in our online store. In addition, we have removed the price information in the printed main catalogue so that we are always able to offer you the latest prices.

And by the way, production of the catalogue is climate-neutral – just one of our climate-protection measures in our strategy to become 100 % climate-neutral. We outline the other measures on page VI.

Now we hope that we can make your day-to-day business easier with the better structured catalogue and the RIEGLER product variety. To ensure you're even better able to reach your goal. As we promised you: Simply that bit better.

Philipp Wacker
Managing Director
RIEGLER & Co. KG

Jürgen Wacker
Managing Director
RIEGLER & Co. KG

MEASURING PRESSURE AND TEMPERATURE

Capsule-spring, fine-measurement, and differential-pressure manometers

Your manometers for all occasions:

- cost-effective
- reliable
- versatile application

From page



224

MEASURING PRESSURE AND TEMPERATURE

Manometer double shut-off valves

Shut-off and throttling devices for your measuring application:

- liquids
- gases
- vapors

From page

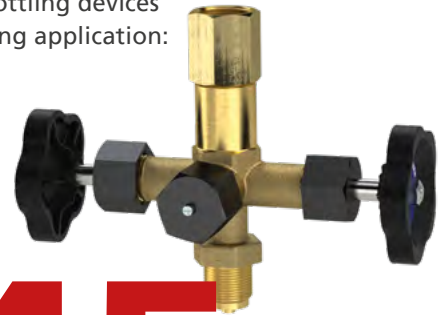

245

NEW INPUT FOR BETTER OUTPUT.

VALVES AND SHUT-OFF DEVICES

Media-separated magnetic valves

For fluid control in your systems:

- 2/2- and 3/2-way versions
- resistant to a wide range of media
- meet common drinking water requirements

From page



331

CYLINDERS AND CONTROL VALVES

Rodless cylinders

Individually configured for you:

- robust and compact design
- with integrated sliding guide
- flexible variants for every application

From page



403



HOSE COUPLINGS

Safety couplings

The product development for your safety:

- two-stage decoupling and bleeding
- optimized performance and safety
- universal application

From page

530



SCREW FITTINGS AND CONNECTING PARTS

Stainless steel screw fittings

Suitable for your application:

- G thread according to ISO 228-1
- R and Rp thread according to ISO 7/1
- corrosion-resistant, long-lasting, variably applicable

From page

735



HOSES AND ACCESSORIES

Plastic blow gun

Select your connection:

- standard connection at the bottom
- optional connection at the top
 - little effort, good ergonomics
 - no kinked hoses, better safety

From page

893



HOSES AND ACCESSORIES

Digital hand-loop filling gauge

Target value clearly recognizable:

- easy readability
- accurate display
- protected from impact damage

From page

906



All the data in the catalogue is subject to change. We reserve the right to make amendments of any kind without warning. The prices given in this catalogue represent the status when this catalogue went to press and do not take into account individually agreed discounts, etc. We retain the right to amend prices. The definitive price will be that of the time of your order.

PERFECTION IS WHEN NOTHING'S LEFT OVER AFTERWARDS.

WE ALWAYS GO ALL-IN. INCLUDING IN CLIMATE PROTECTION.

As of 2021, we have been 100-percent climate-neutral! How do we do it? We have our total CO₂ emissions professionally calculated by ClimatePartner GmbH. And that corporate carbon footprint then forms the basis for our sustainable climate protection strategy: First of all, we are implementing a reduction plan to save as many emissions as possible through our own efforts or, at best, to avoid them altogether. For example, by using 100 % green electricity, energy-saving programs, or a sustainable mobility concept.

OUR CARBON FOOTPRINT 2021.

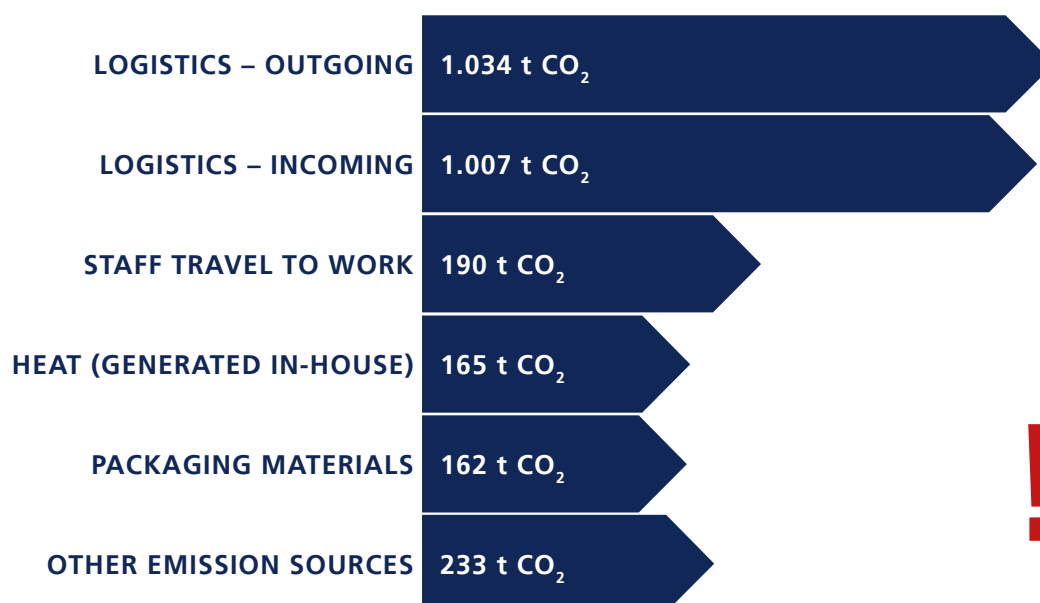

By the way, our catalogue is of course completely offset and thus climate-neutral.



LOGISTICS – INCOMING

Rethinking global freight transport to reduce emissions.



FLIGHTS

Modern means of communication, travel by train instead of cars or flights.



PACKAGING

Saving or reusing packaging, especially RESY cardboard boxes.



STAFF TRAVEL TO WORK

Working from home and bicycle leasing for sustainable mobility.



POWER, WATER, HEAT

100 % green electricity, green IT, infrared heaters, and LED lighting.



WASTE DISPOSAL

100 % recycling with ALBA "resources SAVED by recycling".



SUSTAINABLE VEHICLE FLEET

Our fleet will be completely converted to electric and hybrid drives by 2030.



AVOIDING PAPER

We are increasingly switching to paperless and use only recycled papers with low grammage. Shipping is climate-neutral via "GoGreen".



CLIMATE-NEUTRAL OUTGOING LOGISTICS

Climate-neutral shipping of our packages via GLS KlimaProtect

AVOIDING IS BETTER. OFFSETTING IS LOGICAL.

We offset unavoidable CO₂ emissions by supporting sustainable projects.

- BIOMASS (ELIMINATING COAL)
in Soacha, Colombia / annual volume:
1.526,06 t CO₂
- WIND POWER
in northeastern Brazil / annual volume:
1.526,06 t CO₂

NATURALLY. DOING. MORE.

In addition to economic growth, we encourage sustainable local development. At our premises, green spaces become flower meadows. We use Doppler drinking bottles made from recycled ocean plastic, glass bottles instead of disposable ones, and fully automated coffee machines instead of coffee pods. We also house bee colonies and donate to NABU in lieu of Christmas gifts.



„AS A BUSINESSMAN, COMPANY OWNER, AND HUMAN BEING, I BELIEVE IT IS ESSENTIAL NOT TO LEAVE A NEGATIVE CARBON FOOTPRINT BEHIND.“

Philipp Wacker, Managing Partner of RIEGLER & Co. KG.



**STANDING
STILL? NOT
IN OUR DNA**



65,000

STOREHOUSES

60%

**ELECTRONIC
ORDERING**

18,653

CUSTOMERS WORLDWIDE

200,000

**ORDERS DISPATCHED
A YEAR**

98%

RECOMMENDATIONS

**FROM NOW ON,
YOU'LL FIND
EVERYTHING
FIVE TIMES
EASIER.**

**OUR FIVE NEW PRODUCT
CATEGORIES GIVE YOU
A BETTER OVERVIEW AND
SIMPLIFY ACCESS.**



We have divided our 30,000 products into five categories. The decisive criteria are the material used, workmanship, performance, functionality, and design of the respective product. This way, you immediately know which product meets your requirements exactly.



WE'VE MADE IT REALLY SIMPLE:

SIMPLE FOR EVERY APPLICATION.

Convincing quality, attractive prices.

EASY |

ADDED QUALITY AND FUNCTIONALITY.

Advanced capabilities, selected materials, optimal conditions.

PLUS ||

MAXIMUM PERFORMANCE TO MEET THE HIGHEST STANDARDS.

Modern technologies, versatile functions, highest material and manufacturing quality.

MAX |||

IF SOMETHING SPECIAL IS REQUIRED:

FLEXIBLY APPLIED TECHNOLOGY FOR SPECIFIC REQUIREMENTS.

Individual solutions and special products – in series.

FLEX |||

AND WE DEVELOP CUSTOMIZED SOLUTIONS JUST FOR YOU:

CUSTOMIZED SOLUTIONS.

Ready-to-use assemblies, developed exactly according to your requirements.

YOU

PROMISES ARE GOOD. PERFORMANCE IS BETTER.

WE'LL FIND THE RIGHT ANSWERS TO ALL YOUR QUESTIONS REGARDING COMPRESSED AIR AND PNEUMATIC TECHNOLOGIES.



Professional sales support
Partner online stores
Diverse content delivery



SERVICES

- Wide range of products
- Supplier bundling
- Professional technical support
- On-site support throughout Germany
- Article recoding
- Neutral shipping



QUALITY

- Internal quality assurance (CAQ)
- Certified according to DIN ISO 9001
- VTH quality partner to technical retail
- 100 % re-buyer
- Article change management



eWORLD

- Online store
- Scanner solutions
- CAD data
- Electronic catalogues
- Interface solutions
- Excellent data quality as service+
- Application videos and webisodes

RIEGLER ACADEMY

SUPPORT
LEARN
WORKSHOP
DEVELOP
SKILLS
KNOWLEDGE
PROBLEM SOLVING
GOALS
EXPERIENCE

We place great emphasis on always keeping you up to date with the latest knowledge, which is why we provide you with regular training in compressed air technology and pneumatics.

SEMINAR OFFERINGS

DAY SEMINARS IN BAD URACH

DIGITAL SEMINAR OFFER



- Compressed air technology
- Pneumatics
- RIEGLER SAFETY
- RIEGLER Energy

If on-site sessions are not possible, we offer 1.5-hour webinars on demand.



WE MAKE IT SPECIALLY FOR YOU.

IRRESPECTIVE OF WHAT INDUSTRY
YOU'RE IN – THE BEST SOLUTION
IS THE ONE THAT FITS YOU PERFECTLY.



What we do, we do right:

- Engineering, planning, and construction of individual assembly modules
- Economically projected and developed customer solutions
- Ready-to-install pneumatics up to certified pneumatic control cabinets
- CAD development: project planning, modeling, rendering, animations
- Sample and prototype construction, plus 3D prototyping
- On-site consulting and service
- Services in logistics and security
- QS-tested quality

Rapid production of standard cylinders according to ISO 15552 in single-unit quantities and small batches. Whenever:

- stroke lengths in millimeter increments are required.
- the standard stroke is sometimes out of stock.
- piston rods in extended or continuous design are required.
- the piston rod is to be made of stainless steel.
- the cylinder is to be used at high temperatures up to +150 °C.
- delivery time is 3 to 4 working days.
- express delivery within 48 hours – if orders are received before 12 noon.



THIS IS US

1

SERVICE UNITS

Service units »Standard-mini« and »Standard« Series Page 24–42	Service units »multifix-mini« and »multifix« Series Page 43–78	Service units »variobloc« Series Page 79–91	Combined service units Page 92–93	Special filters »AirClean« Page 94–98	Service units »FUTURA-mini« and »FUTURA« Series Page 99–144	Pressure regulators and filters for high pressures Page 146–150

2

PRESSURE AND TEMPERATURE MEASUREMENT

Standard pressure gauges Page 204–214	Glycerine pressure gauges Page 215–221	Pressure gauges robust type Page 222–223	Pressure gauges for welding Page 223	Capsule pressure gauges Page 224–227	Micrometre pressure gauges Page 228–229	Differential pressure gauges Page 230

3

VALVES AND SHUT-OFF DEVICES

In-line ball valves nickel-plated brass/ stainless steel Page 274–288	Safety ball valves Page 289–292	Mini ball valves Page 293–297	3-way ball valves Page 300–303	High-pressure ball valves Page 304	Ball valves with pneumatic actuator Page 305–312	Ball valves with electric actuator Page 313–314

4

CYLINDERS AND CONTROL VALVES

Pneumatic cylinders Page 374–402	Piston rod-free cylinders Page 403–413	Booster Page 414–415	Pilot valves Page 416–428	NAMUR valves Page 429–431	Miniature solenoid valves Page 432–433	Foot-operated valves Page 434

5

HOSE COUPLINGS

Quick disconnect couplings NW 2.7 Page 472–476	Quick disconnect couplings NW 5 Page 477–484	Quick disconnect couplings NW 7.2 Page 485–499	Quick disconnect couplings NW 7.8 Page 500–505	Compressed air distributor system type »Multi-Link« Page 506	Quick disconnect couplings NW 10 Page 507–509	Quick disconnect couplings NW 12 and NW 19 Page 510–513

6

SCREW FITTINGS AND CONNECTORS

Push-in fittings Page 594–666	Screw fittings Page 667–677	Tube fittings Page 678–689	Tube connectors Page 690–698	Standard screw fittings brass Page 699–712	Standard screw fittings nickel-plated brass Page 713–726	Standard screw fittings stainless steel 1.4571 Page 727–734

7

HOSES AND ACCESSORIES

PA/PUR/PE hoses Page 820–828	PVC hoses Page 829–835	Spiral hoses Page 836–840	Spiral hose kits Page 841–842	Other hoses Page 843–850	Tube protections Page 851–852	Hose winders/ Electric cable winders Page 853–858



INFORMATION AND TABLES





From page 922



								
Special products	Pressure regulators and filters for water	Special pressure regulators	Other service units »inline«	Oil-water separators/ Drain for compressed air condensate	Flowmeters/ Hand-held measurement unit	Leak detector	Proportional valves	Service units made of stainless steel
Page 151–161	Page 162–170	Page 171–173	Page 174–179	Page 180–181	Page 182–184	Page 185	Page 186–189	Page 190–199









							
Contact pressure gauges	Diaphragm pressure gauges	Stainless steel pressure gauges	Accessories for pressure gauges	Digital pressure gauges	Pressure transmitters	Digital display units	Thermometers
Page 231	Page 232	Page 233–240	Page 241–250	Page 251	Page 252–255	Page 256	Page 257–259

								
Butterfly valves	Coaxial valves	Angle-seat valves with piston actuator	Solenoid valves	Pressure switch	Other shut-off devices	Non-return valves	Safety valves	Strainers
Page 315–316	Page 317–318	Page 319–320	Page 321–337	Page 338–347	Page 348–354	Page 355–359	Page 360–365	Page 366–368

				
Valve terminals	Logic elements	Other pneumatic valves	Inline function connectors	Function fittings
Page 435–437	Page 438–439	Page 439	Page 440–450	Page 451–461

								
Quick disconnect couplings, both side sealing	Safety couplings NW 5.5 to NW 11	Non-interchangeable couplings	Hydraulic couplings, both sides sealing	GEKA couplings	Claw couplings	Temperature control couplings	KAMLOK hose couplings	Storz couplings
Page 514–516	Page 517–546	Page 547–550	Page 551–557	Page 558–561	Page 562–565	Page 566–570	Page 571–575	Page 576–582

						
Standard screw fittings stainless steel 1.4408	Bite-type tube fittings	Distributors, distributor blocks, distributor pieces	Fittings	Malleable iron fittings zinc plated DIN DVGW	Steel fittings	Silencers
Page 735–744	Page 745–770	Page 771–775	Page 776–784	Page 785–797	Page 798–800	Page 801–809

								
Hose holder	Compressed air system »speedfit« and »sharkbite«	Sealing materials	Hose clips	Blow guns	Handheld tyre gauges	Industrial adhesives and technical sprays	Repair Sticks	Receptacle combinations
Page 859	Page 860–875	Page 876–877	Page 878–887	Page 888–903	Page 904–907	Page 908–915	Page 916–917	Page 918–920



**TUNING FOR
YOUR COM-
PRESSED AIR.**

Service units »Standard-mini« Series



Pressure regulators
Page 24-25



Filter regulators
Page 26



Filters
Page 27



Oil-mist lubricators
Page 27



Service units
Page 28-29

Service units »Standard« Series



Pressure regulators
Page 30-31



Constant-pressure regulators
Page 32-33



Filter regulators
Page 34



Filters
Page 35



Special filters
Page 37



Oil-mist lubricators
Page 38

Service units »Standard« Series



Service units
Page 39-41

Service units »multifix-mini« Series



Pressure regulators
Page 43



Pressure regulators for mounting side by side
Page 44



Filter regulators
Page 45



Filters
Page 46



Special filters
Page 47-49



Oil-mist lubricators
Page 50



Service units
Page 51-52



Manifolds
Page 53



Ball valves
Page 53



3/2-way valves
Page 54

Service units »multifix-mini« Series



Start-up valves
Page 55

Service units »multifix« Series



Pressure regulators
Page 56



Pressure regulators for mounting side by side
Page 58



Precision pressure regulators
Page 59



Pressure regulators with pneumatic remote control
Page 60



Filter regulators
Page 61



Filters
Page 63



Special filters
Page 64, 66-67



Oil-mist lubricators
Page 68



Service units
Page 69, 71



Service units sets
Page 73



Service units »multifix« Series



Manifolds
Page 74



Ball valves
Page 75



3/2-way valves
Page 76



Start-up valves
Page 77



Non-return valves
Page 78

Service units »variobloc« Series



Pressure regulators
Page 79



Pressure regulators for mounting side by side
Page 80



Precision pressure regulators
Page 81



Filter regulators
Page 82



Filters
Page 83



Special filters
Page 84-85

Service units »variobloc« Series



Oil-mist lubricators
Page 86



Service units
Page 87-88



Manifolds
Page 89



Ball valves
Page 89



Ball valves with pneumatic drive
Page 90



3/2-way valves
Page 90



Start-up valves
Page 91



Connecting elements
Page 91

Combined service units



Combined service units
Page 92



Service units »ONE« Series
Page 93

Special filters »AirClean« & »VMA«



Pre-filters
Page 94, 96



Micro-filters
Page 95, 97



Activated carbon filters
Page 95-96, 98

Service units »FUTURA-mini« Series



Pressure regulators
Page 99



Pressure regulators for mounting side by side
Page 100



Filter regulators
Page 101



Filters
Page 102



Special filters
Page 103-105



Oil-mist lubricators
Page 106



Service units
Page 107-108





Manifold
Page 109

Service units »FUTURA-mini« Series

 Manifold with pressure switch
Page 110

 Ball valve
Page 110

 3/2-way valves, electrically operated
Page 111

 3/2-way valve, pneumatically operated
Page 112

 Start-up valve
Page 112

 Filling units, electrically operated
Page 113

 Filling unit, pneumatically operated
Page 114

 Non-return valve
Page 114

Service units »FUTURA« Series

 Pressure regulators
Page 115

 Pressure regulators for mounting side by side
Page 116-117

 Precision pressure regulators
Page 118

Service units »FUTURA« Series

 Precision pressure regulators for mounting side by side
Page 119

 Filter regulators
Page 120-122

 Filters
Page 123

 Special filters
Page 125, 127-128

 Oil-mist lubricators
Page 129

 Service units
Page 130-135

 Manifolds
Page 136

 Manifolds with pressure switch
Page 137

 Ball valves
Page 138

 3/2-way valves, electrically operated
Page 139

 3/2-way valves, pneumatically operated
Page 140

Service units »FUTURA-mini« Series

 Start-up valves
Page 141

 Non-return valves
Page 142

 Differential pressure flow meter
Page 143-144

Accessories

 Fully-automatic drain valve
Page 145

 Special pneumatic oil
Page 145

Pressure regulators and filters for high pressures

 Large pressure regulators
Page 146

 High-pressure regulators up to 60 bar
Page 147

 Filters for high pressure
Page 148-149

 Micro-filters for high pressure
Page 150



Special products



Pressure regulators pneumatic remote control
Page 151



Precision filter regulators
Page 152



Precision pressure regulators
Page 153-157



Precision pilot regulators (feedback)
Page 157



Precision pressure regulators pneumatic remote control
Page 158



Heavy-duty pressure regulators
Page 159



Inline pressure regulators up to 200 bar
Page 159



Cylinder pressure regulators
Page 160

Pressure regulators and filters for water



Pressure regulators for water
Page 162-164



Pressure regulators for drinking water
Page 164-167



Back-flushing filters
Page 168

Pressure regulators and filters for water



Fine filters
Page 169



Back-flushing filters with pressure regulator
Page 170

Special pressure regulators



Pressure limiting valves
Page 171



Pressure regulators non-reversible
Page 172

Other service units (»inline«)



Inline pressure regulators without self-relieving
Page 174



Inline pressure regulators with self-relieving
Page 174-175



Inline pressure regulators, for water and compressed air applications
Page 176



Filters
Page 176-177



Mini pressure regulators
Page 177



Pressure reducing valves
Page 178

Other service units (»inline«)



Mini oil-mist lubricator
Page 178



Double piston pressure multiplier (boosters)
Page 179

Oil-water separators / Drains for compressed air condensate



Oil-water separators
Page 180



Drains for compressed air condensate
Page 181

Flowmeters / Hand-held measurement unit



Hand-held measurement unit
Page 182



Flowmeters
Page 183-184

Leak detector



Leak detector
Page 185

Proportional valves



Proportional control valves, »sentronic LP« type
Page 186

Proportional valves



Proportional control valves
»sentronic D« type
Page 187



Proportional control valves
»posiflow« type
Page 188



Plug amplifier /
chopper amplifier
Page 189

Service units made of stainless steel



Pressure regulators
Page 190-193









Filter regulators
Page 194-196



Filters
Page 197-199



Series	»Standard-mini« series	»Standard« series	»multifix-mini« series
Model			
Description (applications/ features)	<ul style="list-style-type: none"> ■ small dimensions ■ for high pressure ranges ■ metal housing ■ for industrial applications 	<ul style="list-style-type: none"> ■ for high pressure ranges ■ connection sizes up to G 2" for high flow capacities ■ metal housing ■ compressed air quality as per DIN ISO 8573-1 ■ durable design for the most extreme requirements in rough daily practice ■ Simple operation ■ not sensitive to impact 	<ul style="list-style-type: none"> ■ small dimensions with very good flow capacity values ■ metal housing ■ flexible due to modular design ■ connection of the components with low installation effort ■ compressed air quality as per DIN ISO 8573-1 ■ for industrial applications
Size (BG)	0	1, 2, 3, 4	0
Connection size	G 1/8, G 1/4	G 1/4, G 3/8, G 1/2, G 3/4, G 1, G 1 1/4, G 1 1/2, G 2, G 3*	G 1/8, G 1/4
Supply pressure max.	25 bar	40 bar	16 bar
Control ranges	between 0.1 bar and 16 bar	between 0.1 bar and 16 bar	between 0.1 bar and 16 bar
Flow (filter regulator)	up to 350 l/min	up to 12000 l/min	up to 1450 l/min
Temperature range	max. 60 °C	max. 60 °C	max. 60 °C
Container with protective cage / metal container	- / Standard	Standard / Standard	- / Standard
Condensate drain semi-automatic / fully automatic	Standard / Option	Standard / Option	Standard / Option
Lockable	-	-	Standard
Handwheel lockable / locking	Standard / -	- / -	Standard / Option
Secondary venting	Standard	Standard	Standard
Oil feeding device	-	-	-
Direct wall fastening / fastening bracket	- / Option	- / Option	- / Option
Device designs / variants			
Pressure regulator	+	+	+
Stackable pressure regulator	-	-	+
Precision pressure regulator	-	-	-
Stackable precision pressure regulator	-	-	-
Filter regulator	+	+	+
Filter / pre-filter / micro-filter / active charcoal filter	+ / - / - / -	+ / + / + / +	+ / + / + / +
Mist oiler	+	+	+
Service units, 2-part	+	+	+
Service units, 3-part	+	+	+
Maintenance station "SAFETY"	-	-	-
Distributor	-	-	+
3/2-way ball valves	-	-	+
3/2 way directional valves	-	-	+
Start-up valves	-	-	+
Filling units	-	-	-
Differential pressure flow meter	-	-	-
Check valves	-	-	-

»multifix« series	»variobloc« series	»FUTURA-mini« series	»FUTURA« series
			
<ul style="list-style-type: none"> ■ very good flow capacity ■ metal housing ■ flexible due to modular design ■ connection of the components with low installation effort ■ compressed air quality as per DIN ISO 8573-1 ■ for industrial applications ■ high product diversity 	<ul style="list-style-type: none"> ■ for high inlet pressures ■ good flow capacity ■ metal housing ■ flexible due to modular design ■ connection of the components with low installation effort ■ compressed air quality as per DIN ISO 8573-1 ■ for industrial applications ■ high product diversity 	<ul style="list-style-type: none"> ■ small dimensions with very good flow capacity values ■ high-quality plastics for good stability with low weight ■ flexible due to modular design ■ connection of the components with low installation effort ■ compressed air quality as per DIN ISO 8573-1 	<ul style="list-style-type: none"> ■ very good flow capacity ■ high-quality plastics for good stability with low weight ■ flexible due to modular design ■ connection of the components with low installation effort ■ compressed air quality as per DIN ISO 8573-1 ■ for industrial applications with high demands ■ high product diversity ■ very good standard equipment ■ bayonet connection
1, 3, 4, 5	1, 2	0	1, 2, 4
G 1/4, G 3/8, G 1/2, G 3/4, G 1	G 1/4, G 3/8, G 1/2, G 3/4, G 1	G 1/4	G 1/4, G 3/8, G 1/2, G 3/4, G 1
20 bar	25 bar	12 bar	16 bar
between 0.1 bar and 16 bar	between 0.5 bar and 16 bar	between 0.1 bar and 10 bar	between 0.1 bar and 16 bar
up to 15000 l/min	up to 6500 l/min	up to 1000 l/min	up to 13000 l/min
max. 60 °C	max. 80 °C**	-10 °C to 50 °C	-10 °C to 50 °C
Standard / Standard	Standard / Standard	- / Standard	Standard / Standard
Standard / Option	Option / Option	Standard / Standard	Standard / Standard
Standard	Standard	Standard	Standard
Standard / Option	Standard / Option	Standard / -	Standard / Standard
Standard	Standard	Standard	Standard
-	-	-	Standard
Option / Option	Option / Option	Option / Option	Option / Option
+	+	+	+
+	+	+	+
+	+	-	+
-	-	-	+
+	+	+	+
+ / + / + / +	+ / - / + / +	+ / + / + / +	+ / + / + / +
+	+	+	+
+	+	+	+
+	+	+	+
+	-	-	+
+	+	+	+
+	+	+	+
+	+	+	+
+	+	+	+
-	-	+	+
-	-	-	+
+	-	+	+



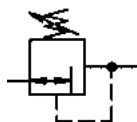

Pressure regulators

»Standard-mini« series

EASY

Reversible diaphragm pressure regulators with self-relieving design in compact design. The pressure setting can be locked by pushing the knob down.

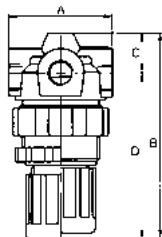

Max. input pressure	25 bar
Max. medium temperature	60 °C
Max. ambient temperature	60 °C
DN	5
Housing	Die-cast zinc, painted silver
Spring bonnet	POM-brass
Sealant	NBR/TPU
Flow rate	340 l/min
Flow rate measurement	At $P_1 = 8$ bar, $P_2 = 6$ bar and pressure drop $\Delta p = 1$ bar



480.23

Pressure regulator incl. pressure gauge

Art. No.	Type No.	Thread	Size	Control range bar	Pressure gauge display bar	A mm	B mm	C mm	D mm
100763	480.11	G 1/8	0	0,1 - 3,5	0 - 4	43.0	72.5	9.5	63.0
100764	480.12	G 1/8	0	0,15 - 7	0 - 10	43.0	72.5	9.5	63.0
100765	480.13	G 1/8	0	0,5 - 10	0 - 16	43.0	72.5	9.5	63.0
100766	480.21	G 1/4	0	0,1 - 3,5	0 - 4	43.0	72.5	9.5	63.0
100767	480.22	G 1/4	0	0,15 - 7	0 - 10	43.0	72.5	9.5	63.0
100768	480.23	G 1/4	0	0,5 - 10	0 - 16	43.0	72.5	9.5	63.0



MV 30



R 11-55



22.480.4

Accessories / spare parts

Art. No.	Type No.	Description
100344	MV 30	Mounting bracket with nut M30x1.5
100345	R 11-55	Nut M30x1.5
100771	22.480.4	Set of wearing parts

Pressure regulators

»Standard-mini« series

EASY

Compact, reversible diaphragm pressure regulators, independent of inlet pressure, with self-relieving design. The pressure setting can be locked by pushing the knob down.

Max. input pressure	25 bar
Max. medium temperature	60 °C
Max. ambient temperature	60 °C
DN	5
Housing	Die-cast zinc, painted silver
Spring bonnet	POM-brass
Sealant	NBR
Flow rate	330 l/min
Flow rate measurement	At $P_1 = 8$ bar, $P_2 = 6$ bar and pressure drop $\Delta p = 1$ bar

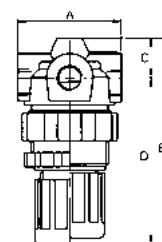
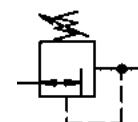

Pressure regulator incl. pressure gauge and panel nut

Art. No.	Type No.	Thread	Size	Control range bar	Pressure gauge display bar	A mm	B mm	C mm	D mm
100772	482.10 A	G 1/8	0	0,1 - 3	0 - 4	40.0	76.3	15.0	61.3
100773	482.10 B	G 1/8	0	0,2 - 6	0 - 10	40.0	76.3	15.0	61.3
100774	482.10 C	G 1/8	0	0,5 - 10	0 - 16	40.0	76.3	15.0	61.3
100775	482.10 D	G 1/8	0	0,5 - 16	0 - 25	40.0	76.3	15.0	61.3
100776	482.20 A	G 1/4	0	0,1 - 3	0 - 4	40.0	76.3	15.0	61.3
100777	482.20 B	G 1/4	0	0,2 - 6	0 - 10	40.0	76.3	15.0	61.3
100778	482.20 C	G 1/4	0	0,5 - 10	0 - 16	40.0	76.3	15.0	61.3
100779	482.20 D	G 1/4	0	0,5 - 16	0 - 25	40.0	76.3	15.0	61.3



482.10 C

Accessories / spare parts

Art. No.	Type No.	Description
100344	MV 30	Mounting bracket with nut M30x1.5
100345	R 11-55	Nut M30x1.5
100780	22.482.4	Set of wearing parts



MV 30

R 11-55



22.482.4

1

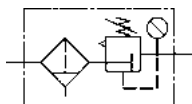

Filter regulators

»Standard-mini« series

EASY

Compact, reversible diaphragm pressure regulators, independent of inlet pressure, with self-relieving design, combined with a centrifugal separator. The pressure setting can be locked by pushing the knob down.

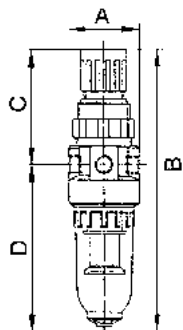

578.00 K-HA

Max. medium temperature	60 °C
Max. ambient temperature	60 °C
Control range	0,5 - 10 bar
Pressure gauge display	0 - 16 bar
DN	5
Housing	Die-cast zinc, painted silver
Spring bonnet	POM-brass
Sealant	NBR
Filter rating	5 µm
Flow rate	350 l/min
Condensate drain	semi-automatic
Flow rate measurement	At P ₁ = 8 bar, P ₂ = 6 bar and pressure drop Δ _p = 1 bar

Filter regulator with polycarbonate bowl, incl. pressure gauge and panel nut

Art. No.	Type No.	Thread	Size	Max. input pressure bar	A mm	B mm	C mm	D mm
100781	578.00 K-HA	G 1/8	0	16	40.0	167.0	65.0	102.0
100782	578.01 K-HA	G 1/4	0	16	40.0	167.0	65.0	102.0



MV 30

R 11-55



640/1-HA

KS 11 F-A



611.6.905

22.501.4



655.6.900

Accessories / spare parts

Art. No.	Type No.	Description
100344	MV 30	Mounting bracket with nut M30x1.5
100345	R 11-55	Nut M30x1.5
100357	640/1-HA	Polycarbonate bowl (filter)
100361	KS 11 F-A	Polycarbonate bowl with automatic draining
100134	611.6.905	Filter element 5 µm, Cellpor
100362	655.6.900	Automatic drain valve
100785	22.501.4	Set of wearing parts

Filters

»Standard-mini« series

EASY

Centrifugal separators with a sintered filter element. Compact design.

Max. medium temperature	60 °C
Max. ambient temperature	60 °C
DN	5
Housing	Die-cast zinc, painted silver
Sealant	NBR
Filter rating	8 µm
Flow rate	800 l/min
Condensate drain	semi-automatic
Flow rate measurement	At P ₂ = 6 bar and pressure drop Δ _p = 1 bar

Filter with polycarbonate bowl

Art. No.	Type No.	Thread	Size	Max. input pressure bar	A mm	B mm	C mm	D mm
100786	640.106 K-HA	G 1/8	0	16	40.0	112.0	10.0	102.0
100787	640.107 K-HA	G 1/4	0	16	40.0	112.0	10.0	102.0

Accessories / spare parts

Art. No.	Type No.	Description
100357	640/1-HA	Polycarbonate bowl (filter)
100361	KS 11 F-A	Polycarbonate bowl with automatic draining
100134	611.6.905	Filter element 5 µm, Cellpor
100362	655.6.900	Automatic drain valve

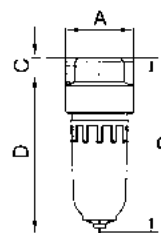
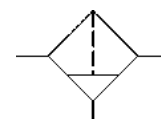

640.106 K-HA



640/1-HA



KS 11 F-A



611.6.905



655.6.900

Oil-mist lubricators

»Standard-mini« series

EASY

Proportional lubricators in compact design, oil can be filled under pressure.

Max. medium temperature	60 °C
Max. ambient temperature	60 °C
DN	5
Housing	Die-cast zinc, painted silver
Sealant	NBR
Oil grade	CL 32 acc. to DIN 51517-ISO VG 32
Flow rate	650 l/min
Flow rate measurement	At P ₁ = 6 bar and pressure drop Δ _p = 1 bar

Oil-mist lubricator with polycarbonate bowl and PA sight dome

Art. No.	Type No.	Thread	Size	Max. input pressure bar	A mm	B mm	C mm	D mm
100790	743 K	G 1/8	0	16	40.0	144.5	49.5	95.0
100791	744 K	G 1/4	0	16	40.0	144.5	49.5	95.0

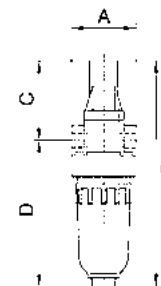
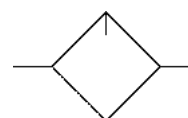

744 K

➔ We recommend our special pneumatic oil on page 145

Oil-mist lubricators

»Standard-mini« series



Accessories / spare parts		
Art. No.	Type No.	Description
100383	740/01	Polycarbonate bowl (lubricator)
100794	760.7.990	Sight dome, polycarbonate
100795	760.7.992	Sight dome, metal
100796	760.7.1135	Assembly adapter for metal sight dome

Service units

two-piece, »Standard-mini« series

EASY

Compact, two-piece service units consisting of a reversible diaphragm pressure regulator, independent of inlet pressure, with self-relieving design, combined with a centrifugal separator and a proportional lubricator.

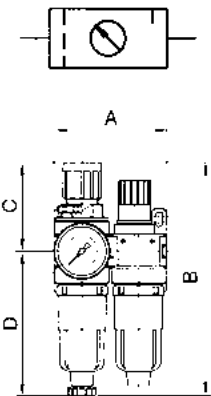

Control range	0,5 - 10 bar
Pressure gauge display	0 - 16 bar
Max. medium temperature	60 °C
Max. ambient temperature	60 °C
DN	5
Housing	Die-cast zinc, painted silver
Sealant	NBR
Filter rating	5 µm
Condensate drain	semi-automatic
Flow rate measurement	At P ₁ = 8 bar, P ₂ = 6 bar and pressure drop Δ _p = 1 bar



824 K

Service unit, 2-piece with polycarbonate bowl and pressure gauge, PA sight dome										
Art. No.	Type No.	Thread	Size	Max. input pressure bar	Flow rate l/min	A mm	B mm	C mm	D mm	
100797	823 K	G 1/8	0	16	350	85.0	167.0	65.0	102.0	
100798	824 K	G 1/4	0	16	350	85.0	167.0	65.0	102.0	

➔ We recommend our special pneumatic oil on page 145



Accessories / spare parts		
Art. No.	Type No.	Description
100344	MV 30	Mounting bracket with nut M30x1.5
100345	R 11-55	Nut M30x1.5
100357	640/1-HA	Polycarbonate bowl (filter)
100383	740/01	Polycarbonate bowl (lubricator)
100361	KS 11 F-A	Polycarbonate bowl with automatic draining
100780	22.482.4	Set of wearing parts
100785	22.501.4	Set of wearing parts
100134	611.6.905	Filter element 5 µm, Cellpor
100362	655.6.900	Automatic drain valve
100794	760.7.990	Sight dome, polycarbonate
100795	760.7.992	Sight dome, metal
100796	760.7.1135	Assembly adapter for metal sight dome

Service units

three-piece, »Standard-mini« series

EASY

Compact, three-piece service units consisting of a reversible diaphragm pressure regulator, independent of inlet pressure, with self-relieving design, combined with a centrifugal separator and a proportional lubricator.

Control range	0,5 - 10 bar
Pressure gauge display	0 - 16 bar
Max. medium temperature	60 °C
Max. ambient temperature	60 °C
DN	5
Housing	Die-cast zinc, painted silver
Sealant	NBR
Filter rating	5 µm
Condensate drain	semi-automatic
Flow rate measurement	At $P_1 = 8 \text{ bar}$, $P_2 = 6 \text{ bar}$ and pressure drop $\Delta p = 1 \text{ bar}$

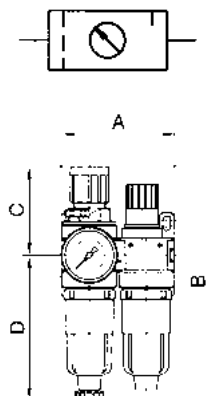

Service unit, 3-piece with polycarbonate bowl and pressure gauge, PA sight dome

Art. No.	Type No.	Thread	Size	Max. input pressure bar	Flow rate l/min	A mm	B mm	C mm	D mm
100801	845.01 K	G 1/8	0	16	300	130.0	151.5	49.5	102.0
100802	845.02 K	G 1/4	0	16	300	130.0	151.5	49.5	102.0



845.02 K

→ We recommend our special pneumatic oil on page 145

Accessories / spare parts

Art. No.	Type No.	Description
100344	MV 30	Mounting bracket with nut M30x1.5
100345	R 11-55	Nut M30x1.5
100357	640/1-HA	Polycarbonate bowl (filter)
100383	740/01	Polycarbonate bowl (lubricator)
100361	KS 11 F-A	Polycarbonate bowl with automatic draining
100780	22.482.4	Set of wearing parts
100785	22.501.4	Set of wearing parts
100134	611.6.905	Filter element 5 µm, Cellpor
100362	655.6.900	Automatic drain valve
100794	760.7.990	Sight dome, polycarbonate
100795	760.7.992	Sight dome, metal
100796	760.7.1135	Assembly adapter for metal sight dome



MV 30

R 11-55



640/1-HA

740/01



KS 11 F-A

22.482.4

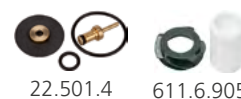

22.501.4

611.6.905



655.6.900

760.7.990



760.7.992

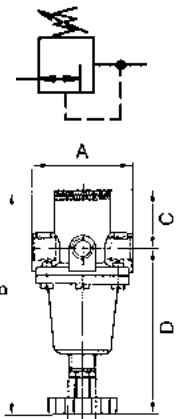

Pressure regulators

»Standard« series

EASY

Reversible diaphragm pressure regulators, independent of inlet pressure, with self-relieving design.

Max. medium temperature	60 °C
Max. ambient temperature	80 °C
Housing	Die-cast zinc, painted silver
Sealant	NBR
Flow rate measurement	At $P_1 = 8$ bar, $P_2 = 6$ bar and pressure drop $\Delta p = 1$ bar



637.20 C



637.35 C



637.45 C

Pressure regulator, incl. pressure gauge

Art. No.	Type No.	Thread	Size	Max. input pressure bar	Control range bar	Pressure gauge display bar	Flow rate l/min	DN	A mm	B mm	D mm
100805	637.10 A	G 1/4	1	16	0,1 - 3	0 - 4	1000	6	54.0	129.5	97.5
100806	637.10 B	G 1/4	1	16	0,2 - 6	0 - 10	1000	6	54.0	129.5	97.5
100807	637.10 C	G 1/4	1	16	0,5 - 10	0 - 16	1000	6	54.0	129.5	97.5
100808	637.10 D	G 1/4	1	16	0,5 - 16	0 - 25	1000	6	54.0	129.5	97.5
100809	637.20 A	G 3/8	1	16	0,1 - 3	0 - 4	1000	6	54.0	129.5	97.5
100810	637.20 B	G 3/8	1	16	0,2 - 6	0 - 10	1000	6	54.0	129.5	97.5
100811	637.20 C	G 3/8	1	16	0,5 - 10	0 - 16	1000	6	54.0	129.5	97.5
100812	637.20 D	G 3/8	1	16	0,5 - 16	0 - 25	1000	6	54.0	129.5	97.5
100813	637.35 A	G 1/2	2	25	0,1 - 3	0 - 4	2200	15	70.0	145.9	111.9
100814	637.35 B	G 1/2	2	25	0,2 - 6	0 - 10	2200	15	70.0	145.9	111.9
100815	637.35 C	G 1/2	2	25	0,5 - 10	0 - 16	2200	15	70.0	145.9	111.9
100816	637.35 D	G 1/2	2	25	0,5 - 16	0 - 25	2200	15	70.0	145.9	111.9
100817	637.40 A	G 3/4	3	25	0,1 - 3	0 - 4	5000	20	90.0	163.4	132.4
100818	637.40 B	G 3/4	3	25	0,2 - 6	0 - 10	5000	20	90.0	163.4	132.4
100819	637.40 C	G 3/4	3	25	0,5 - 10	0 - 16	5000	20	90.0	163.4	132.4
100820	637.40 D	G 3/4	3	25	0,5 - 16	0 - 25	5000	20	90.0	163.4	132.4
100821	637.45 A	G 1	3	25	0,1 - 3	0 - 4	5000	25	90.0	163.4	132.4
100822	637.45 B	G 1	3	25	0,2 - 6	0 - 10	5000	25	90.0	163.4	132.4
100823	637.45 C	G 1	3	25	0,5 - 10	0 - 16	5000	25	90.0	163.4	132.4
100824	637.45 D	G 1	3	25	0,5 - 16	0 - 25	5000	25	90.0	163.4	132.4
100825	637.50 A	G 1 1/4	4	25	0,1 - 3	0 - 4	16500	25	125.0	252.5	200.5
100826	637.50 C	G 1 1/4	4	25	0,5 - 10	0 - 16	16500	25	125.0	252.5	200.5
100827	637.50 D	G 1 1/4	4	25	0,5 - 16	0 - 25	16500	25	125.0	252.5	200.5
100828	637.55 A	G 1 1/2	4	25	0,1 - 3	0 - 4	16500	35	125.0	252.5	200.5
100829	637.55 C	G 1 1/2	4	25	0,5 - 10	0 - 16	16500	35	125.0	252.5	200.5
100830	637.55 D	G 1 1/2	4	25	0,5 - 16	0 - 25	16500	35	125.0	252.5	200.5



74/1

75/2

Accessories / spare parts for pressure regulator G 1/4 and G 3/8

Art. No.	Type No.	Description
100831	74/1	Nut M20x1.5 and washer
100832	75/1	Mounting bracket with nut and washer
100833	22.620.4	Set of wearing parts



22.620.4

22.635.4

Accessories / spare parts for pressure regulator G 1/2

Art. No.	Type No.	Description
100831	74/1	Nut M20x1.5 and washer
100836	75/2	Mounting bracket with nut and washer
100837	22.635.4	Set of wearing parts

Accessories / spare parts for pressure regulator G 3/4 and G 1

Art. No.	Type No.	Description
100831	74/1	Nut M20x1.5 and washer
100840	H 822	Mounting bracket with screws
100841	22.645.4 K	Set of wearing parts

**Accessories / spare parts for pressure regulator G 1 1/4 and G 1 1/2**

Art. No.	Type No.	Description
100845	H 86	Mounting bracket
100846	22.605.4	Set of wearing parts



Pressure regulators

for panel mounting, »Standard« series

EASY

Incl. panel nut and washer.

Reversible diaphragm pressure regulators, independent of inlet pressure, with self-relieving design.

Max. medium temperature	60 °C
Max. ambient temperature	80 °C
Housing	Die-cast zinc, painted silver
Thread for panel mounting	M20x1.5
Sealant	NBR
Flow rate measurement	At $P_1 = 8$ bar, $P_2 = 6$ bar and pressure drop $\Delta p = 1$ bar

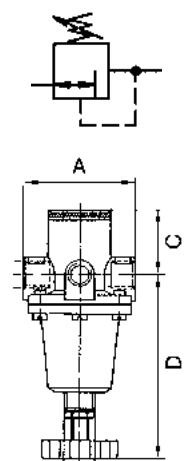
**Pressure regulator incl. panel nut and washer, without pressure gauge**

Art. No.	Type No.	Thread	Size	Max. input pressure bar	Control range bar	Flow rate l/min	DN	A mm	C mm	D mm
100849	637.503 A	G 1/4	1	16	0,5 - 3	1000	6	54.0	32.0	97.5
100850	637.503 B	G 1/4	1	16	0,5 - 6	1000	6	54.0	32.0	97.5
100851	637.503 C	G 1/4	1	16	0,5 - 10	1000	6	54.0	32.0	97.5
100852	637.503 D	G 1/4	1	16	0,5 - 16	1000	6	54.0	32.0	97.5
100853	637.513 A	G 3/8	1	16	0,5 - 3	1000	6	54.0	32.0	97.5
100854	637.513 B	G 3/8	1	16	0,5 - 6	1000	6	54.0	32.0	97.5
100855	637.513 C	G 3/8	1	16	0,5 - 10	1000	6	54.0	32.0	97.5
100856	637.513 D	G 3/8	1	16	0,5 - 16	1000	6	54.0	32.0	97.5
100857	637.523 A	G 1/2	2	25	0,1 - 3	2200	15	70.0	34.0	111.9
100858	637.523 B	G 1/2	2	25	0,5 - 6	2200	15	70.0	34.0	111.9
100859	637.523 C	G 1/2	2	25	0,5 - 10	2200	15	70.0	34.0	111.9
100860	637.523 D	G 1/2	2	25	0,5 - 16	2200	15	70.0	34.0	111.9
100861	637.533 A	G 3/4	3	25	0,1 - 3	5000	20	90.0	31.0	132.4
100862	637.533 B	G 3/4	3	25	0,5 - 6	5000	20	90.0	31.0	132.4
100863	637.533 C	G 3/4	3	25	0,5 - 10	5000	20	90.0	31.0	132.4
100864	637.533 D	G 3/4	3	25	0,5 - 16	5000	20	90.0	31.0	132.4
100865	637.543 A	G 1	3	25	0,1 - 3	5000	25	90.0	31.0	132.4
100866	637.543 B	G 1	3	25	0,5 - 6	5000	25	90.0	31.0	132.4
100867	637.543 C	G 1	3	25	0,5 - 10	5000	25	90.0	31.0	132.4
100868	637.543 D	G 1	3	25	0,5 - 16	5000	25	90.0	31.0	132.4



637.513 C



637.543 C

Accessories / spare parts for pressure regulator G 1/4 and G 3/8

Art. No.	Type No.	Description
100831	74/1	Nut M20x1.5 and washer
100832	75/1	Mounting bracket with nut and washer
100833	22.620.4	Set of wearing parts



1

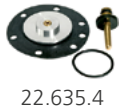

22.635.4



H 822

22.645.4 K

Accessories / spare parts for pressure regulator G 1/2

Art. No.	Type No.	Description
100831	74/1	Nut M20x1.5 and washer
100836	75/2	Mounting bracket with nut and washer
100837	22.635.4	Set of wearing parts

Accessories / spare parts for pressure regulator G 3/4 and G 1

Art. No.	Type No.	Description
100831	74/1	Nut M20x1.5 and washer
100840	H 822	Mounting bracket with screws
100841	22.645.4 K	Set of wearing parts

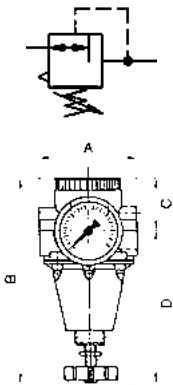

Constant-pressure regulators

EASY

Reversible diaphragm pressure regulators, independent of inlet pressure, with self-relieving design. The pressure regulators maintain a constant working pressure regardless of variations in the inlet pressure.

Max. medium temperature	60 °C
Max. ambient temperature	90 °C
Sealant	NBR
Flow rate measurement	At $P_1 = 8 \text{ bar}$, $P_2 = 6 \text{ bar}$ and pressure drop $\Delta p = 1 \text{ bar}$

Constant-pressure regulator incl. pressure gauge



737.301

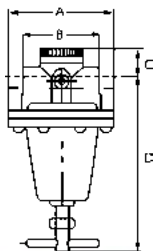

737.601

Art. No.	Type No.	Thread	Size	Max. input pressure bar	Housing	Control range bar	Flow rate l/min	A mm	B mm	D mm
100869	737.301	G 1/4	1	25	Die-cast zinc	0,5 - 3	3000	77.0	165.0	132.0
100870	737.302	G 1/4	1	25	Die-cast zinc	0,5 - 6	2500	77.0	165.0	132.0
100871	737.303	G 1/4	1	25	Die-cast zinc	0,5 - 10	2000	77.0	165.0	132.0
100872	737.304	G 1/4	1	25	Die-cast zinc	0,5 - 16	1600	77.0	165.0	132.0
100873	737.311	G 3/8	1	25	Die-cast zinc	0,5 - 3	3000	70.0	165.0	132.0
100874	737.312	G 3/8	1	25	Die-cast zinc	0,5 - 6	2500	70.0	165.0	132.0
100875	737.313	G 3/8	1	25	Die-cast zinc	0,5 - 10	2000	70.0	165.0	132.0
100876	737.314	G 3/8	1	25	Die-cast zinc	0,5 - 16	1600	70.0	165.0	132.0
100877	737.401	G 3/8	2	25	Die-cast zinc	0,5 - 3	3500	90.0	170.0	138.0
100878	737.402	G 3/8	2	25	Die-cast zinc	0,5 - 6	3000	90.0	170.0	138.0
100879	737.403	G 3/8	2	25	Die-cast zinc	0,5 - 10	2670	90.0	170.0	138.0
100880	737.404	G 3/8	2	25	Die-cast zinc	0,5 - 16	2000	90.0	170.0	138.0
100881	737.501	G 1/2	2	25	Die-cast zinc	0,5 - 3	3500	82.0	170.0	138.0
100882	737.502	G 1/2	2	25	Die-cast zinc	0,5 - 6	3000	82.0	170.0	138.0
100883	737.503	G 1/2	2	25	Die-cast zinc	0,5 - 10	2670	82.0	170.0	138.0
100884	737.504	G 1/2	2	25	Die-cast zinc	0,5 - 16	2000	82.0	170.0	138.0
100885	737.601	G 3/4	3	40	Brass	0,5 - 3	8700	116.0	93.0	177.0
100886	737.602	G 3/4	3	40	Brass	0,5 - 6	8200	116.0	93.0	177.0
100887	737.603	G 3/4	3	40	Brass	0,5 - 10	7830	116.0	93.0	177.0
100888	737.604	G 3/4	3	40	Brass	0,5 - 16	7400	116.0	93.0	172.0
100889	737.605	G 3/4	3	40	Brass	0,5 - 25	6500	116.0	93.0	172.0

Constant-pressure regulators

EASY
Constant-pressure regulator incl. pressure gauge

Art. No.	Type No.	Thread	Size	Max. input pressure bar	Housing	Control range bar	Flow rate l/min	A mm	B mm	D mm
100890	737.701	G 1	3	40	Brass	0,5 - 3	8700	116.0	81.0	177.0
100891	737.702	G 1	3	40	Brass	0,5 - 6	8200	116.0	81.0	177.0
100892	737.703	G 1	3	40	Brass	0,5 - 10	7830	116.0	81.0	177.0
100893	737.704	G 1	3	40	Brass	0,5 - 16	7400	116.0	81.0	172.0
100894	737.705	G 1	3	40	Brass	0,5 - 25	6500	116.0	81.0	172.0
100895	737.801	G 1 1/4	4	40	Brass	0,5 - 3	16000	114.0	126.0	189.0
100896	737.802	G 1 1/4	4	40	Brass	0,5 - 6	14000	114.0	126.0	189.0
100897	737.803	G 1 1/4	4	40	Brass	0,5 - 10	12160	114.0	126.0	189.0
100898	737.804	G 1 1/4	4	40	Brass	0,5 - 16	11000	114.0	126.0	184.0
100899	737.805	G 1 1/4	4	40	Brass	0,5 - 25	8500	114.0	126.0	184.0
100900	737.901	G 1 1/2	4	40	Brass	0,5 - 3	16000	114.0	114.0	189.0
100901	737.902	G 1 1/2	4	40	Brass	0,5 - 6	14000	114.0	114.0	189.0
100902	737.903	G 1 1/2	4	40	Brass	0,5 - 10	12160	114.0	114.0	189.0
100903	737.904	G 1 1/2	4	40	Brass	0,5 - 16	11000	114.0	114.0	184.0
100904	737.905	G 1 1/2	4	40	Brass	0,5 - 25	8500	114.0	114.0	184.0

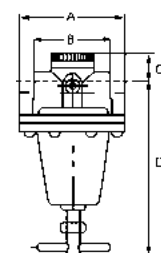
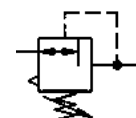
Accessories / spare parts for G 1/4 and G 3/8 (Size 1)

Art. No.	Type No.	Description
100831	74/1	Nut M20x1.5 and washer
100836	75/2	Mounting bracket with nut and washer
100905	22.733.4	Set of wearing parts



74/1



22.733.4



75/2

Accessories / spare parts for G 3/8 and G 1/2 (Size 2)

Art. No.	Type No.	Description
100909	74/3	Panel mounting kit (lock nut M22x1)
100836	75/2	Mounting bracket with nut and washer
100910	22.753.4	Set of wearing parts



22.753.4

Accessories / spare parts for G 3/4 and G 1 (Size 3)

Art. No.	Type No.	Description
100914	H 88	Mounting bracket with 2 screws
100915	22.773.4	Set of wearing parts



22.773.4



H 88

Accessories / spare parts for G 1 1/4 and G 1 1/2 (Size 4)

Art. No.	Type No.	Description
100914	H 88	Mounting bracket with 2 screws
100919	22.793.4	Set of wearing parts



22.793.4

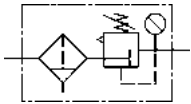

Filter regulators

»Standard« series

EASY

Reversible diaphragm pressure regulators, independent of inlet pressure, with selfrelieving design, combined with a centrifugal separator.

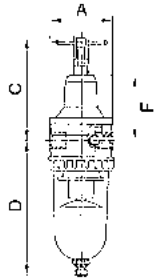

Max. medium temperature	60 °C
Max. ambient temperature	60 °C
Sealant	NBR
Condensate drain	Semi-automatic
Flow rate measurement	At $P_1 = 8$ bar, $P_2 = 6$ bar and pressure drop $\Delta p = 1$ bar



578.020 K-HA



578.020 S

Filter regulator with polycarbonate bowl

Art. No.	Type No.	Thread	Size	Max. input pressure bar	Control range bar	Filter rating μm	Flow rate l/min	A mm	C mm	D mm	F mm
100922	578.020 K-HA	G 1/4	1	16	0,5 - 10	5	900	54.0	106.5	129.7	62.0
100923	578.030 K-HA	G 3/8	1	16	0,5 - 10	5	900	54.0	106.5	129.7	62.0
100924	678.020 K-HA	G 3/8	2	16	0,5 - 10	40	1500	70.0	120.5	145.9	76.5
100925	678.41 K-HA	G 1/2	3	16	0,5 - 10	5	3000	82.0	130.0	169.4	83.0
174092	678.42 K-HA P	G 3/4	4	16	0,5 - 10	40	12000	125.0	129.0	263.0	
174093	678.43 K-HA P	G 1	4	16	0,5 - 10	40	12000	125.0	129.0	263.0	

Filter regulator with polycarbonate bowl and bowl guard

Art. No.	Type No.	Thread	Size	Max. input pressure bar	Control range bar	Filter rating μm	Flow rate l/min	A mm	C mm	D mm	F mm
100928	578.020 S	G 1/4	1	16	0,5 - 10	5	900	54.0	106.5	129.7	62.0
100929	578.030 S	G 3/8	1	16	0,5 - 10	5	900	54.0	106.5	129.7	62.0
100930	678.020 S	G 3/8	2	16	0,5 - 10	40	1500	70.0	120.5	145.9	76.5
100931	678.41 S	G 1/2	3	16	0,5 - 10	5	3000	82.0	130.0	169.4	83.0
174094	678.42 S P	G 3/4	4	16	0,5 - 10	40	12000	125.0	129.0	263.0	
174095	678.43 S P	G 1	4	16	0,5 - 10	40	12000	125.0	129.0	263.0	

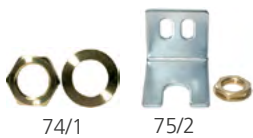

74/1

75/2



SK 01



640/2-HA

Accessories / spare parts for filter regulator G 1/4 and G 3/8 (Size 1)

Art. No.	Type No.	Description
100831	74/1	Nut M20x1.5 and washer
100836	75/2	Mounting bracket with nut and washer
100940	SK 01	Bowl guard
100941	640/2-HA	Polycarbonate bowl (filter)
100677	65/0-N	Fully-automatic drain valve
100134	611.6.905	Filter element 5 μm , Cellpor
100943	22.520.4	Set of wearing parts
100362	655.6.900	Automatic drain valve



22.602.4

611.6.905



65/0-N



655.6.900

Accessories / spare parts for filter regulator G 3/8 (Size 2)

Art. No.	Type No.	Description
100831	74/1	Nut M20x1.5 and washer
100836	75/2	Mounting bracket with nut and washer
100944	SK 02	Bowl guard
100946	650/1-HA	Polycarbonate bowl (filter)
100677	65/0-N	Fully-automatic drain valve
100945	652.6.940	Filter element 40 μm , sintered bronze
100948	22.602.4	Set of wearing parts
100362	655.6.900	Automatic drain valve



650/1-HA



652.6.940

Accessories / spare parts for filter regulator G 1/2 (Size 3)

Art. No.	Type No.	Description
100831	74/1	Nut M20x1.5 and washer
100836	75/2	Mounting bracket with nut and washer

Accessories / spare parts for filter regulator G 1/2 (Size 3)

Art. No.	Type No.	Description
100949	SK 03	Bowl guard
100950	650/2-HA	Polycarbonate bowl (filter)
100677	65/0-N	Fully-automatic drain valve
100952	22.641.4	Set of wearing parts
100507	633.6.905	Filter element 5 µm, Cellpor
100362	655.6.900	Automatic drain valve



650/2-HA 22.641.4



633.6.905 H 86



655.6.905.2 655.6.940

Accessories / spare parts for filter regulator G 3/4 and G 1 (Size 4)

Art. No.	Type No.	Description
100845	H 86	Mounting bracket
100949	SK 03	Bowl guard
100950	650/2-HA	Polycarbonate bowl (filter)
100677	65/0-N	Fully-automatic drain valve
205521	655.6.905.2	Filter element 5 µm, Cellpor
100511	655.6.940	Filter element 40 µm, Cellpor
174104	22.643.4 P	Set of wearing parts
100362	655.6.900	Automatic drain valve

Filters

»Standard« series

EASY

Centrifugal separators with a sintered filter element.

Max. medium temperature	60 °C
Max. ambient temperature	60 °C
Housing	Die-cast zinc, painted silver
Condensate drain	Semi-automatic
Flow rate measurement	At P ₂ = 6 bar and pressure drop Δp = 1 bar

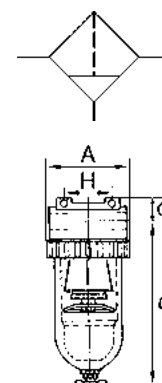

Filter with polycarbonate bowl

Art. No.	Type No.	Thread	Size	Max. input pressure bar	Filter rating µm	Flow rate l/min	A mm	C mm	D mm	H mm
100954	640.116 K-HA	G 1/4	1	16	5	800	48.0	14.0	131.6	38.0
100955	640.126 K-HA	G 3/8	1	16	5	800	48.0	14.0	131.6	38.0
206300	650 B/K-HA.2	G 3/8	2	16	5	3100	70.0	16.0	145.7	50.0
100957	650 C/K-HA	G 1/2	3	16	5	4000	79.0	18.0	168.4	50.0
100958	650 D/K-HA	G 3/4	3	16	5	4000	102.0	26.5	169.9	50.0
100959	650 E/K-HA	G 1	3	16	5	4000	90.0	26.5	169.9	50.0
100960	650 F/K-HA	G 1 1/4	4	16	40	12500	125.0	36.5	243.4	105.0
100961	650 G/K-HA	G 1 1/2	4	16	40	12500	125.0	36.5	243.4	105.0
100962	650 H/K-HA	G 2	5	16	60	30000	148.0	41.0	394.4	120.0



650 C/K-HA



650 B/K-HA.2



650 C/S

Filter with polycarbonate bowl and bowl guard

Art. No.	Type No.	Thread	Size	Max. input pressure bar	Filter rating µm	Flow rate l/min	A mm	C mm	D mm	H mm
100963	640.116 S	G 1/4	1	16	5	800	48.0	14.0	131.6	38.0
100964	640.126 S	G 3/8	1	16	5	800	48.0	14.0	131.6	38.0
206301	650 B/S.2	G 3/8	2	16	5	3100	70.0	16.0	145.7	50.0
100966	650 C/S	G 1/2	3	16	5	4000	79.0	18.0	168.4	50.0
100967	650 D/S	G 3/4	3	16	5	4000	102.0	26.5	169.9	50.0
100968	650 E/S	G 1	3	16	5	4000	90.0	26.5	169.9	50.0
100969	650 F/S	G 1 1/4	4	16	40	12500	125.0	36.5	243.4	105.0
100970	650 G/S	G 1 1/2	4	16	40	12500	125.0	36.5	243.4	105.0
100971	650 H/S	G 2	5	16	60	30000	148.0	41.0	394.4	120.0

→ G 2 1/2 and G 3 filters available on request

1



Accessories / spare parts for filter G 1/4 and G 3/8 (Size 1)

Art. No.	Type No.	Description
100981	H 800	Mounting bracket with 2 screws
100941	640/2-HA	Polycarbonate bowl (filter)
100940	SK 01	Bowl guard
100677	65/0-N	Fully-automatic drain valve
100134	611.6.905	Filter element 5 µm, Cellpor
100362	655.6.900	Automatic drain valve



Accessories / spare parts for filter G 3/8 (Size 2)

Art. No.	Type No.	Description
100982	H 801	Mounting bracket with 2 screws
100946	650/1-HA	Polycarbonate bowl (filter)
100944	SK 02	Bowl guard
100677	65/0-N	Fully-automatic drain valve
100507	633.6.905	Filter element 5 µm, Cellpor
100362	655.6.900	Automatic drain valve



Accessories / spare parts for filter G 1/2 (Size 3)

Art. No.	Type No.	Description
100982	H 801	Mounting bracket with 2 screws
100950	650/2-HA	Polycarbonate bowl (filter)
100949	SK 03	Bowl guard
100677	65/0-N	Fully-automatic drain valve
100507	633.6.905	Filter element 5 µm, Cellpor
100983	653.6.908	Filter element 8 µm, sintered bronze
100984	653.6.940	Filter element 40 µm, sintered bronze
100362	655.6.900	Automatic drain valve



Accessories / spare parts for filter G 1 1/4 and G 1 1/2 (Size 4)

Art. No.	Type No.	Description
100950	650/2-HA	Polycarbonate bowl (filter)
100949	SK 03	Bowl guard
100677	65/0-N	Fully-automatic drain valve
100511	655.6.940	Filter element 40 µm, Cellpor
100362	655.6.900	Automatic drain valve
205521	655.6.905.2	Filter element 5 µm, Cellpor



Accessories / spare parts for filter G 2 (Size 5)

Art. No.	Type No.	Description
100950	650/2-HA	Polycarbonate bowl (filter)
100949	SK 03	Bowl guard
100677	65/0-N	Fully-automatic drain valve
100985	658.6.9600	Filter element 60 µm, cellpor
100986	658.6.908	Filter element 8 µm, sintered bronze
100362	655.6.900	Automatic drain valve
119623	658.6.9008	Filter element 8 µm, Cellpor



Special filters

»Standard« series

EASY

For all applications with particularly strict compressed air purity requirements. The separating efficiency of these filters permits very fine oil vapour particles and micro-fine suspended particles to be filtered. A standard filter should always be connected upstream to trap coarse impurities and protect the micro-filter inserts.

Max. medium temperature	50 °C
Max. ambient temperature	50 °C
Max. input pressure	16 bar
Housing	Die-cast zinc, painted silver
Filter rating	0.01 µm
Efficiency	99.999 %
Flow rate measurement	At $P_2 = 6$ bar and pressure drop $\Delta p = 1$ bar

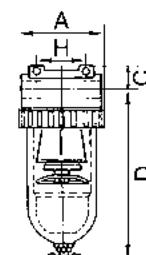
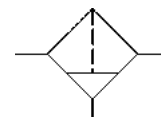

Special filter with polycarbonate bowl

Art. No.	Type No.	Thread	Size	Flow rate l/min	Condensate drain	A mm	C mm	D mm	H mm
100988	673 K-HA	G 1/4	1	380	Semi-automatic	48.0	14.0	131.6	38.0
100989	674 K-HA	G 3/8	1	380	Semi-automatic	48.0	14.0	131.6	38.0
100990	675 K-HA	G 3/8	2	720	Semi-automatic	70.0	16.0	145.7	50.0
100991	685 K-HA	G 1/2	3	1250	Semi-automatic	79.0	18.0	168.4	50.0
100992	695 K	G 3/4	4	7000	Manuel	133.0	36.0	206.0	134.0
100993	696 K	G 1	4	7000	Manuel	133.0	36.0	206.0	120.0



675 K-HA

Special filter with polycarbonate bowl and bowl guard

Art. No.	Type No.	Thread	Size	Flow rate l/min	Condensate drain	A mm	C mm	D mm	H mm
100994	673 S	G 1/4	1	380	Semi-automatic	48.0	14.0	131.6	38.0
100995	674 S	G 3/8	1	380	Semi-automatic	48.0	14.0	131.6	38.0
100996	675 S	G 3/8	2	720	Semi-automatic	70.0	16.0	145.7	50.0
100997	685 S	G 1/2	3	1250	Semi-automatic	79.0	18.0	168.4	50.0
100998	695 S	G 3/4	4	7000	Manuel	133.0	36.0	206.0	134.0
100999	696 S	G 1	4	7000	Manuel	133.0	36.0	206.0	120.0



685 S

Accessories / spare parts for special filter G 1/4 and G 3/8 (Size 1)

Art. No.	Type No.	Description
100981	H 800	Mounting bracket with 2 screws
100941	640/2-HA	Polycarbonate bowl (filter)
100940	SK 01	Bowl guard
101006	360/1	Filter element, borosilicate-aluminium



H 800

640/2-HA

Accessories / spare parts for special filter G 3/8 (Size 2)

Art. No.	Type No.	Description
100982	H 801	Mounting bracket with 2 screws
100946	650/1-HA	Polycarbonate bowl (filter)
100944	SK 02	Bowl guard
101007	360/2	Filter element, borosilicate-aluminium



SK 03

360/2

Accessories / spare parts for special filter G 1/2 (Size 3)

Art. No.	Type No.	Description
100982	H 801	Mounting bracket with 2 screws
100950	650/2-HA	Polycarbonate bowl (filter)
100949	SK 03	Bowl guard
101008	360/3	Filter element, borosilicate-aluminium



650/2-HA

360/3

1



Accessories / spare parts for special filter G 3/4 and G 1 (Size 4)

Art. No.	Type No.	Description
101013	SK 04	Bowl guard
101010	360/4	Filter element, borosilicate-aluminium

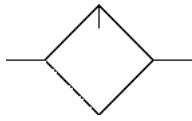

Oil-mist lubricators

»Standard« series

EASY

Proportional lubricators, oil can be filled under pressure.

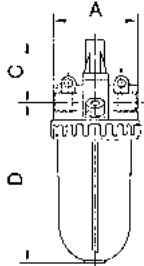

Max. medium temperature	60 °C
Max. ambient temperature	60 °C
Housing	Die-cast zinc, painted silver
Sealant	NBR
Oil grade	CL 32 acc. to DIN 51517-ISO VG 32
Flow rate measurement	At $P_2 = 6$ bar and pressure drop $\Delta p = 1$ bar



760 K

Oil-mist lubricator with polycarbonate bowl and PA sight dome

Art. No.	Type No.	Thread	Size	Max. input pressure bar	Flow rate l/min	DN	A mm	C mm	D mm
101014	745 K	G 1/4	1	16	1200	6	50.0	51.0	118.0
101015	748 K	G 3/8	1	16	1200	6	50.0	51.0	118.0
101016	750 K	G 3/8	2	16	2400	10	70.0	51.0	129.5
101017	760 K	G 1/2	3	16	4000	15	79.0	55.0	157.0
101018	761 K	G 3/4	3	16	9000	20	102.0	58.0	160.0
101019	762 K	G 1	3	16	9000	25	90.0	58.0	160.0
101020	763 K	G 1 1/4	4	16	9000	40	137.0	70.0	232.0
101021	764 K	G 1 1/2	4	16	9000	45	125.0	70.0	232.0



760 S

Oil-mist lubricator with polycarbonate bowl and bowl guard, PA sight dome

Art. No.	Type No.	Thread	Size	Max. input pressure bar	Flow rate l/min	DN	A mm	C mm	D mm
101022	745 S	G 1/4	1	16	1200	6	50.0	51.0	118.0
101023	748 S	G 3/8	1	16	1200	6	50.0	51.0	118.0
101024	750 S	G 3/8	2	16	2400	10	70.0	51.0	129.5
101025	760 S	G 1/2	3	16	4000	15	79.0	55.0	157.0
101026	761 S	G 3/4	3	16	9000	20	102.0	58.0	160.0
101027	762 S	G 1	3	16	9000	25	90.0	58.0	160.0
101028	763 S	G 1 1/4	4	16	9000	40	137.0	70.0	232.0
101029	764 S	G 1 1/2	4	16	9000	45	125.0	70.0	232.0

➔ We recommend our special pneumatic oil on page 145



H 800

740/03

Accessories / spare parts for oil-mist lubricator G 1/4 and G 3/8 (Size 1)

Art. No.	Type No.	Description
100981	H 800	Mounting bracket with 2 screws
101039	740/02	Polycarbonate bowl (lubricator)
100940	SK 01	Bowl guard
100794	760.7.990	Sight dome, polycarbonate
100795	760.7.992	Sight dome, metal
100796	760.7.1135	Assembly adapter for metal sight dome



SK 03

760.7.990

Accessories / spare parts for oil-mist lubricator G 3/8 (Size 2)

Art. No.	Type No.	Description
100982	H 801	Mounting bracket with 2 screws
101042	740/03	Polycarbonate bowl (lubricator)
100944	SK 02	Bowl guard
100794	760.7.990	Sight dome, polycarbonate

Accessories / spare parts for oil-mist lubricator G 3/8 (Size 2)

100795	760.7.992	Sight dome, metal
100796	760.7.1135	Assembly adapter for metal sight dome



Accessories / spare parts for oil-mist lubricator G 1/2 (Size 3)

Art. No.	Type No.	Description
100982	H 801	Mounting bracket with 2 screws
101044	740/04	Polycarbonate bowl (lubricator)
100949	SK 03	Bowl guard
100794	760.7.990	Sight dome, polycarbonate
100795	760.7.992	Sight dome, metal
100796	760.7.1135	Assembly adapter for metal sight dome



Accessories / spare parts for oil-mist lubricator G 3/4 and G 1 (Size 3)

Art. No.	Type No.	Description
100982	H 801	Mounting bracket with 2 screws
101044	740/04	Polycarbonate bowl (lubricator)
100949	SK 03	Bowl guard
100794	760.7.990	Sight dome, polycarbonate
100795	760.7.992	Sight dome, metal
100796	760.7.1135	Assembly adapter for metal sight dome

Accessories / spare parts for oil-mist lubricator G 1 1/4 and G 1 1/2 (Size 4)

Art. No.	Type No.	Description
101044	740/04	Polycarbonate bowl (lubricator)
100949	SK 03	Bowl guard
100794	760.7.990	Sight dome, polycarbonate
101045	760.7.994	Sight dome, metal



Service units

two-part, »Standard« series

EASY

Two-piece service units consisting of a reversible diaphragm pressure regulator, independent of inlet pressure, with self-relieving design, combined with a centrifugal separator and a proportional lubricator.

Max. medium temperature	60 °C
Max. ambient temperature	60 °C
Housing	Die-cast zinc / aluminium, painted silver
Sealant	NBR
Condensate drain	Semi-automatic
Flow rate measurement	At P ₁ = 8 bar, P ₂ = 6 bar and pressure drop Δp = 1 bar

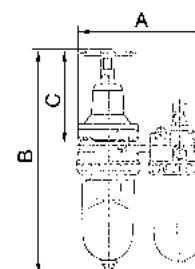
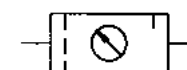

Service unit, 2-piece with polycarbonate bowl and PA sight dome

Art. No.	Type No.	Thread	Size	Max. input pressure bar	Control range bar	Filter rating μm	Flow rate l/min	A mm	B mm	C mm
101046	825 K	G 1/4	1	16	0,5 - 10	5	600	117.0	236.2	106.5
101047	827 K	G 3/8	1	16	0,5 - 10	5	600	117.0	236.2	106.5
101048	849 K	G 3/8	2	16	0,5 - 10	40	800	150.0	266.4	120.5
101049	861 K	G 1/2	3	16	0,5 - 10	5	2100	175.0	299.4	130.0
174098	865 K P	G 3/4	4	16	0,5 - 10	40	4000	222.0	392.0	129.0
174099	866 K P	G 1	4	16	0,5 - 10	40	4000	222.0	392.0	129.0



Service unit, 2-piece with polycarbonate bowl and bowl guard, PA sight dome

Art. No.	Type No.	Thread	Size	Max. input pressure bar	Control range bar	Filter rating μm	Flow rate l/min	A mm	B mm	C mm
101052	825 S	G 1/4	1	16	0,5 - 10	5	600	117.0	236.2	106.5
101053	827 S	G 3/8	1	16	0,5 - 10	5	600	117.0	236.2	106.5
101054	849 S	G 3/8	2	16	0,5 - 10	40	800	150.0	266.4	120.5

→ We recommend our special pneumatic oil on page 145

1

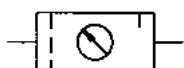

Service units

two-part, »Standard« series

EASY

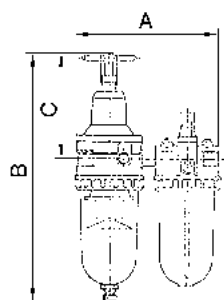

Service unit, 2-piece with polycarbonate bowl and bowl guard, PA sight dome

Art. No.	Type No.	Thread	Size	Max. input pressure bar	Control range bar	Filter rating µm	Flow rate l/min	A mm	B mm	C mm
101055	861 S	G 1/2	3	16	0,5 - 10	5	2100	175.0	299.4	130.0
174100	865 S P	G 3/4	4	16	0,5 - 10	40	4000	222.0	392.0	129.0
174101	866 S P	G 1	4	16	0,5 - 10	40	4000	222.0	392.0	129.0

→ We recommend our special pneumatic oil on page 145



861 S



Accessories / spare parts for service unit G 1/4 and G 3/8 (Size 1)

Art. No.	Type No.	Description
100832	75/1	Mounting bracket with nut and washer
100981	H 800	Mounting bracket with 2 screws
100941	640/2-HA	Polycarbonate bowl (filter)
101039	740/02	Polycarbonate bowl (lubricator)
100940	SK 01	Bowl guard
100677	65/0-N	Fully-automatic drain valve
100943	22.520.4	Set of wearing parts
100134	611.6.905	Filter element 5 µm, Cellpor
100794	760.7.990	Sight dome, polycarbonate
100795	760.7.992	Sight dome, metal
100796	760.7.1135	Assembly adapter for metal sight dome
100362	655.6.900	Automatic drain valve

Accessories / spare parts for service unit G 3/8 (Size 2)

Art. No.	Type No.	Description
100836	75/2	Mounting bracket with nut and washer
100982	H 801	Mounting bracket with 2 screws
100946	650/1-HA	Polycarbonate bowl (filter)
101042	740/03	Polycarbonate bowl (lubricator)
100944	SK 02	Bowl guard
100677	65/0-N	Fully-automatic drain valve
100948	22.602.4	Set of wearing parts
100945	652.6.940	Filter element 40 µm, sintered bronze
100794	760.7.990	Sight dome, polycarbonate
100795	760.7.992	Sight dome, metal
100796	760.7.1135	Assembly adapter for metal sight dome
100362	655.6.900	Automatic drain valve

Accessories / spare parts for service unit G 1/2 (Size 3)

Art. No.	Type No.	Description
100836	75/2	Mounting bracket with nut and washer
100982	H 801	Mounting bracket with 2 screws
100950	650/2-HA	Polycarbonate bowl (filter)
101044	740/04	Polycarbonate bowl (lubricator)
100949	SK 03	Bowl guard
100677	65/0-N	Fully-automatic drain valve
100952	22.641.4	Set of wearing parts
100794	760.7.990	Sight dome, polycarbonate
100507	633.6.905	Filter element 5 µm, Cellpor
100795	760.7.992	Sight dome, metal
100796	760.7.1135	Assembly adapter for metal sight dome
100362	655.6.900	Automatic drain valve

Accessories / spare parts for service unit G 3/4 and G 1 (Size 4)

Art. No.	Type No.	Description
100845	H 86	Mounting bracket
100950	650/2-HA	Polycarbonate bowl (filter)
101044	740/04	Polycarbonate bowl (lubricator)
100949	SK 03	Bowl guard
100677	65/0-N	Fully-automatic drain valve
174104	22.643.4 P	Set of wearing parts
100511	655.6.940	Filter element 40 µm, Cellpor
100794	760.7.990	Sight dome, polycarbonate
100795	760.7.992	Sight dome, metal
100796	760.7.1135	Assembly adapter for metal sight dome
100362	655.6.900	Automatic drain valve
205521	655.6.905.2	Filter element 5 µm, Cellpor

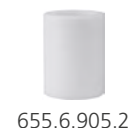

Service units

three-piece, »Standard« series

EASY

Three-piece service units consisting of a reversible diaphragm pressure regulator, independent of inlet pressure, with self-relieving design, centrifugal separator and proportional lubricator.

Max. medium temperature	60 °C
Max. ambient temperature	60 °C
Housing	Die-cast zinc / aluminium, painted silver
Sealant	NBR
Condensate drain	Semi-automatic
Flow rate measurement	At $P_1 = 8$ bar, $P_2 = 6$ bar and pressure drop $\Delta p = 1$ bar

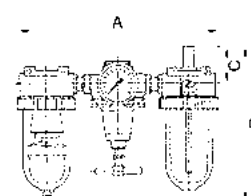
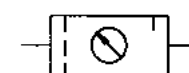

Service unit, 3-piece with polycarbonate bowl and PA sight dome

Art. No.	Type No.	Thread	Size	Max. input pressure bar	Control range bar	Filter rating µm	Flow rate l/min	A mm	B mm	C mm
101064	845 B	G 1/4	1	16	0,5 - 10	5	600	172.0	182.6	51.0
101065	847 K	G 3/8	1	16	0,5 - 10	5	600	185.0	182.6	51.0
206302	850 B.2	G 3/8	2	16	0,5 - 10	5	1400	232.0	196.7	51.0
101067	850 C	G 1/2	3	16	0,5 - 10	5	3200	259.0	223.4	55.0
101068	850 D	G 3/4	3	16	0,5 - 10	5	3200	302.0	227.9	58.0
101069	850 E	G 1	3	16	0,5 - 10	5	3200	302.0	227.9	58.0
101070	850 F	G 1 1/4	4	16	0,5 - 10	40	5000	395.0	313.4	70.0
101071	850 H	G 1 1/2	4	16	0,5 - 10	40	5000	395.0	313.4	70.0



Service unit, 3-piece with polycarbonate bowl and bowl guard, PA sight dome

Art. No.	Type No.	Thread	Size	Max. input pressure bar	Control range bar	Filter rating µm	Flow rate l/min	A mm	B mm	C mm
101072	845 B/S	G 1/4	1	16	0,5 - 10	5	600	172.0	182.6	51.0
101073	847 K/S	G 3/8	1	16	0,5 - 10	5	600	185.0	182.6	51.0
206303	850 B/S.2	G 3/8	2	16	0,5 - 10	5	1400	232.0	196.7	51.0
101075	850 C/S	G 1/2	3	16	0,5 - 10	5	3200	259.0	223.4	55.0
101076	850 D/S	G 3/4	3	16	0,5 - 10	5	3200	302.0	227.9	58.0
101077	850 E/S	G 1	3	16	0,5 - 10	5	3200	302.0	227.9	58.0
101078	850 F/S	G 1 1/4	4	16	0,5 - 10	40	5000	395.0	313.4	70.0
101079	850 H/S	G 1 1/2	4	16	0,5 - 10	40	5000	395.0	313.4	70.0



→ We recommend our special pneumatic oil on page 145

Accessories / spare parts for service unit G 1/4 and G 3/8 (Size 1)

Art. No.	Type No.	Description
100836	75/2	Mounting bracket with nut and washer
100981	H 800	Mounting bracket with 2 screws



Accessories / spare parts for service unit G 1/4 and G 3/8 (Size 1)

Artikel Nr.	Typen Nr.	Beschreibung
100941	640/2-HA	Polycarbonate bowl (filter)
101039	740/02	Polycarbonate bowl (lubricator)
100940	SK 01	Bowl guard
100677	65/0-N	Fully-automatic drain valve
100833	22.620.4	Set of wearing parts
100134	611.6.905	Filter element 5 µm, Cellpor
100794	760.7.990	Sight dome, polycarbonate
100795	760.7.992	Sight dome, metal
100796	760.7.1135	Assembly adapter for metal sight dome
100362	655.6.900	Automatic drain valve

Accessories / spare parts for service unit G 1/2 (Size 3)

Art. No.	Type No.	Description
100836	75/2	Mounting bracket with nut and washer
100982	H 801	Mounting bracket with 2 screws
100950	650/2-HA	Polycarbonate bowl (filter)
101044	740/04	Polycarbonate bowl (lubricator)
100949	SK 03	Bowl guard
100677	65/0-N	Fully-automatic drain valve
100837	22.635.4	Set of wearing parts
100794	760.7.990	Sight dome, polycarbonate
100507	633.6.905	Filter element 5 µm, Cellpor
100795	760.7.992	Sight dome, metal
100796	760.7.1135	Assembly adapter for metal sight dome
100362	655.6.900	Automatic drain valve

Accessories / spare parts for service unit G 3/4 and G 1 (Size 3)

Art. No.	Type No.	Description
100836	75/2	Mounting bracket with nut and washer
100982	H 801	Mounting bracket with 2 screws
100950	650/2-HA	Polycarbonate bowl (filter)
101044	740/04	Polycarbonate bowl (lubricator)
100949	SK 03	Bowl guard
100677	65/0-N	Fully-automatic drain valve
100952	22.641.4	Set of wearing parts
100984	653.6.940	Filter element 40 µm, sintered bronze
100983	653.6.908	Filter element 8 µm, sintered bronze
100794	760.7.990	Sight dome, polycarbonate
100795	760.7.992	Sight dome, metal
100796	760.7.1135	Assembly adapter for metal sight dome
100362	655.6.900	Automatic drain valve

Accessories / spare parts for service unit G 1 1/4 and G 1 1/2 (Size 4)

Art. No.	Type No.	Description
100845	H 86	Mounting bracket
100950	650/2-HA	Polycarbonate bowl (filter)
101044	740/04	Polycarbonate bowl (lubricator)
100949	SK 03	Bowl guard
100677	65/0-N	Fully-automatic drain valve
205521	655.6.905.2	Filter element 5 µm, Cellpor
100846	22.605.4	Set of wearing parts
100511	655.6.940	Filter element 40 µm, Cellpor
100794	760.7.990	Sight dome, polycarbonate
100795	760.7.992	Sight dome, metal
100796	760.7.1135	Assembly adapter for metal sight dome
100362	655.6.900	Automatic drain valve



Pressure regulators

»multifix-mini« series

PLUS

Reversible diaphragm pressure regulators, independent of inlet pressure, with self-relieving design. The pressure setting can be locked by pushing the button down.

Max. input pressure	16 bar
Max. medium temperature	60 °C
Max. ambient temperature	60 °C
DN	5
Housing	Die-cast zinc
Spring bonnet	POM-brass
Sealant	NBR
Flow rate	1450 l/min
Flow rate measurement	At $P_1 = 10$ bar, $P_2 = 6.3$ bar and pressure drop $\Delta p = 1$ bar

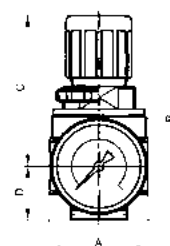
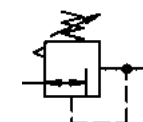

Pressure regulator incl. pressure gauge

Art. No.	Type No.	Thread	Size	Control range bar	Pressure gauge display bar	A mm	B mm	C mm	D mm
100337	R 05-3	G 1/8	0	0,1 - 3	0 - 4	40.0	85.0	63.0	22.0
100338	R 05-6	G 1/8	0	0,2 - 6	0 - 10	40.0	85.0	63.0	22.0
100339	R 05-10	G 1/8	0	0,5 - 10	0 - 16	40.0	85.0	63.0	22.0
100340	R 05-16	G 1/8	0	0,5 - 16	0 - 25	40.0	85.0	63.0	22.0
100341	R 06- 3	G 1/4	0	0,1 - 3	0 - 4	40.0	85.0	63.0	22.0
100342	R 06- 6	G 1/4	0	0,2 - 6	0 - 10	40.0	85.0	63.0	22.0
100343	R 06-10	G 1/4	0	0,5 - 10	0 - 16	40.0	85.0	63.0	22.0



R 06-10

→ Lockable pressure regulators available on request

→ If several devices in the »multifix-mini« Series are assembled together, the maximum working pressure is 12 bar.

Accessories / spare parts

Art. No.	Type No.	Description
100344	MV 30	Mounting bracket with nut M30x1.5
100345	R 11-55	Nut M30x1.5
100346	KP 05	Coupler pack for modular assembly of several devices
100347	22.1805.4	Set of wearing parts



MV 30

R 11-55



KP 05

22.1805.4

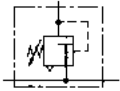

Pressure regulators with continuous pressure supply

»multifix-mini« series

PLUS

Diaphragm pressure regulators with self-relieving design for mounting side by side. The pressure setting can be locked by pushing the button down. By assembling two or more controllers together, it is possible to supply several working air circuits with different output pressures via a single supply line.

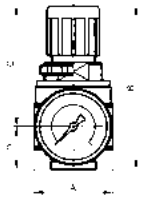

Max. input pressure	16 bar
Max. medium temperature	60 °C
Max. ambient temperature	60 °C
DN	5
Housing	Die-cast zinc
Spring bonnet	POM-brass
Sealant	NBR
Flow rate	1700 l/min
Flow rate measurement	At $P_1 = 10$ bar, $P_2 = 6.3$ bar and pressure drop $\Delta_p = 1$ bar



RB 06-10

Pressure regulator with continuous pressure supply, incl. pressure gauge

Art. No.	Type No.	Thread	Size	Control range bar	Pressure gauge display bar	A mm	B mm	C mm	D mm
100348	RB 06-3	G 1/4	0	0,1 - 3	0 - 4	40.0	85.0	63.0	22.0
100349	RB 06-6	G 1/4	0	0,2 - 6	0 - 10	40.0	85.0	63.0	22.0
100350	RB 06-10	G 1/4	0	0,5 - 10	0 - 16	40.0	85.0	63.0	22.0

- ➔ Lockable pressure regulators available on request
- ➔ If several devices in the »multifix-mini« Series are assembled together, the maximum working pressure is 12 bar.
- ➔ The port for the output pressure (P2) is on the rear! G 1/8



MV 30

R 11-55

KP 05

22.1805.4

Accessories / spare parts

Art. No.	Type No.	Description
100344	MV 30	Mounting bracket with nut M30x1.5
100345	R 11-55	Nut M30x1.5
100346	KP 05	Coupler pack for modular assembly of several devices
100347	22.1805.4	Set of wearing parts

Filter regulators

»multifix-mini« series

PLUS

Reversible diaphragm pressure regulators, independent of inlet pressure, with secondary ventilation, in combination with a centrifugal separator. The pressure setting can be locked by pressing in the handwheel.

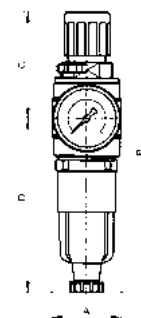
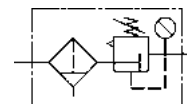

Max. input pressure	16 bar
Max. medium temperature	60 °C
Max. ambient temperature	60 °C
DN	5
Condensate drain	Semi-automatic
Housing	Die-cast zinc
Spring bonnet	POM-brass
Sealant	NBR
Filter rating	5 µm
Flow rate	1450 l/min
Flow rate measurement	At P ₁ = 10 bar, P ₂ = 6.3 bar and pressure drop Δ _p = 1 bar

Filter regulator with polycarbonate bowl and pressure gauge

Art. No.	Type No.	Thread	Size	Control range bar	Pressure gauge display bar	A mm	B mm	C mm	D mm
100351	C 05-K 3-HA	G 1/8	0	0,1 - 3	0 - 4	40.0	165.5	63.0	102.5
100352	C 05-K 10-HA	G 1/8	0	0,5 - 10	0 - 16	40.0	165.5	63.0	102.5
100353	C 06-K 3-HA	G 1/4	0	0,1 - 3	0 - 4	40.0	165.5	63.0	102.5
100354	C 06-K10-HA	G 1/4	0	0,5 - 10	0 - 16	40.0	165.5	63.0	102.5

- Lockable filter regulators available on request
- If several devices in the »multifix-mini« Series are assembled together, the maximum working pressure is 12 bar.



C 05-K 10-HA

Accessories / spare parts

Art. No.	Type No.	Description
100344	MV 30	Mounting bracket with nut M30x1.5
100345	R 11-55	Nut M30x1.5
100346	KP 05	Coupler pack for modular assembly of several devices
100357	640/1-HA	Polycarbonate bowl (filter)
100361	KS 11 F-A	Polycarbonate bowl with automatic draining
100134	611.6.905	Filter element 5 µm, Cellpor
100347	22.1805.4	Set of wearing parts
100362	655.6.900	Automatic drain valve



MV 30

R 11-55



KP 05

640/1-HA



KS 11 F-A

655.6.900



22.1805.4

611.6.905

1

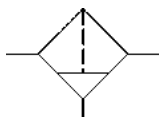

Filters

»multifix-mini« series

PLUS

Centrifugal separators with a sintered filter element.

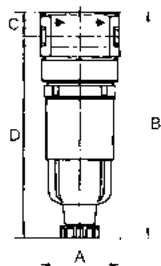

Max. medium temperature	60 °C
Max. ambient temperature	60 °C
DN	5
Condensate drain	Semi-automatic
Housing	Die-cast zinc
Filter rating	5 µm
Flow rate	1000 l/min
Flow rate measurement	At P ₂ = 6 bar and pressure drop Δ _p = 1 bar



F 05 K-HA

Filter with polycarbonate bowl

Art. No.	Type No.	Thread	Size	Max. input pressure bar	A mm	B mm	C mm	D mm
100363	F 05 K-HA	G 1/8	0	16	40.0	114.8	12.3	102.5
100364	F 06 K-HA	G 1/4	0	16	40.0	114.8	12.3	102.5

➔ If several devices in the »multifix-mini« Series are assembled together, the maximum working pressure is 12 bar.

Accessories / spare parts



ZW 05

KP 05



640/1-HA

KS 11 F-A



611.6.905

655.6.900

Art. No.	Type No.	Description
100367	ZW 05	Mounting bracket
100346	KP 05	Coupler pack for modular assembly of several devices
100357	640/1-HA	Polycarbonate bowl (filter)
100361	KS 11 F-A	Polycarbonate bowl with automatic draining
100134	611.6.905	Filter element 5 µm, Cellpor
100362	655.6.900	Automatic drain valve

Pre-filters

»multifix-mini« series

PLUS

For filtering out solid impurities larger than 0.3 µm.

Max. input pressure	16 bar
Max. medium temperature	60 °C
Max. ambient temperature	60 °C
Condensate drain	Semi-automatic
Housing	Die-cast zinc
Sealant	NBR
DN	5
Flow rate measurement	At P ₁ = 6 bar and pressure drop Δ _p = 0.02 bar
Filter rating	0.3 µm
Efficiency	99.999 %
Filter element	Paper-POM

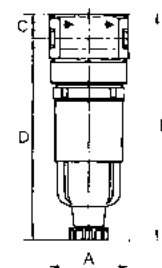
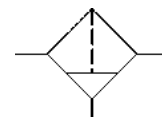

F 05 K-HA

Pre-filter with polycarbonate bowl

Art. No.	Type No.	Thread	Size	Flow rate l/min	A mm	B mm	C mm	D mm
100368	FV 05 K-HA	G 1/8	0	130	40.0	114.8	12.3	102.5
100369	FV 06 K-HA	G 1/4	0	160	40.0	138.1	12.3	125.8

➔ If several devices in the »multifix-mini« Series are assembled together, the maximum working pressure is 12 bar.

Accessories / spare parts for pre-filter G 1/8

Art. No.	Type No.	Description
100367	ZW 05	Mounting bracket
100346	KP 05	Coupler pack for modular assembly of several devices
100357	640/1-HA	Polycarbonate bowl (filter)
100379	V 23/35	Pre-filter element (paper-POM)



Accessories / spare parts for pre-filter G 1/4

Art. No.	Type No.	Description
100367	ZW 05	Mounting bracket
100346	KP 05	Coupler pack for modular assembly of several devices
100380	V 23/60	Pre-filter element (paper-POM)



1

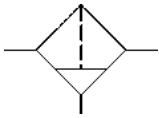

Micro-filters (fine-filters)

»multifix-mini« series

PLUS

For filtering out solid impurities larger than 0.01 µm.

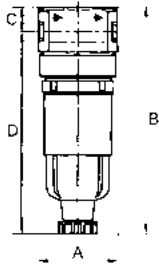

Max. input pressure	16 bar
Max. medium temperature	60 °C
Max. ambient temperature	60 °C
Condensate drain	Semi-automatic
Housing	Die-cast zinc
Sealant	NBR
DN	5
Flow rate measurement	At P ₁ = 6 bar and pressure drop Δ _p = 0.1 bar
Filter rating	0.01 µm
Efficiency	99.999 %
Filter element	Borosilicate-POM
Residual oil content	0.01 mg/m ³



FM 05 K-HA

Micro-filter with polycarbonate bowl

Art. No.	Type No.	Thread	Size	Flow rate l/min	A mm	B mm	C mm	D mm
100372	FM 05 K-HA	G 1/8	0	230	40.0	114.8	12.3	102.5
100373	FM 06 K-HA	G 1/4	0	450	40.0	138.1	12.3	125.8

→ If several devices in the »multifix-mini« Series are assembled together, the maximum working pressure is 12 bar.



ZW 05

KP 05

Accessories / spare parts for micro-filter G 1/8

Art. No.	Type No.	Description
100367	ZW 05	Mounting bracket
100346	KP 05	Coupler pack for modular assembly of several devices
100357	640/1-HA	Polycarbonate bowl (filter)
100381	M 23/40	Micro-filter element (borosilicate-POM)



640/1-HA

M 23/40

Accessories / spare parts for micro-filter G 1/4

Art. No.	Type No.	Description
100367	ZW 05	Mounting bracket
100346	KP 05	Coupler pack for modular assembly of several devices
100382	M 23/60	Micro-filter element (borosilicate-POM)

Activated carbon filters

»multifix-mini« series

PLUS

For filtering odours out of compressed air.

The activated carbon absorbs the oil vapour molecules contained in the compressed air. A separate filter route prevents activated carbon particles from entering the air flow.

Max. input pressure	16 bar
Max. medium temperature	60 °C
Max. ambient temperature	60 °C
Housing	Die-cast zinc
Sealant	NBR
DN	5
Flow rate measurement	At $P_1 = 6$ bar and pressure drop $\Delta p = 0.2$ bar
Residual oil content	0.005 mg/m ³
Filter element	Activated carbon-POM

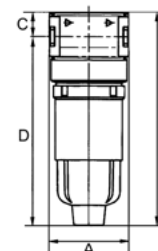
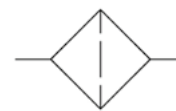

FA 05 K

Activated carbon filter with polycarbonate bowl

Art. No.	Type No.	Thread	Size	Flow rate l/min	A mm	B mm	C mm	D mm
100376	FA 05 K	G 1/8	0	310	40.0	107.8	12.3	95.5
100377	FA 06 K	G 1/4	0	380	40.0	122.8	12.3	110.5

→ If several devices in the »multifix-mini« Series are assembled together, the maximum working pressure is 12 bar.

Accessories / spare parts for activated carbon filter G 1/8

Art. No.	Type No.	Description
100367	ZW 05	Mounting bracket
100346	KP 05	Coupler pack for modular assembly of several devices
100383	740/01	Polycarbonate bowl (lubricator)
100384	A 23/60	Filter element (activated carbon POM)



Accessories / spare parts for activated carbon filter G 1/4

Art. No.	Type No.	Description
100367	ZW 05	Mounting bracket
100346	KP 05	Coupler pack for modular assembly of several devices
100385	KS 11 N	Polycarbonate bowl for lubricator
100386	A 23/80	Filter element (activated carbon POM)



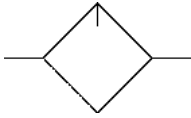

Oil-mist lubricators

»multifix-mini« series

PLUS

Micro-lubricators, oil can be filled under pressure.

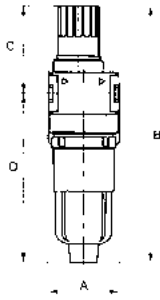

Max. medium temperature	60 °C
Max. ambient temperature	60 °C
DN	5
Housing	Die-cast zinc
Sealant	NBR
Oil grade	CL 32 acc. to DIN 51517-ISO VG 32
Flow rate	1150 l/min
Flow rate measurement	At $P_2 = 6$ bar and pressure drop $\Delta p = 1$ bar



L 05 K

Oil-mist lubricator with polycarbonate bowl and PA sight dome

Art. No.	Type No.	Thread	Size	Max. input pressure bar	A mm	B mm	C mm	D mm
100387	L 05 K	G 1/8	0	16	40.0	145.1	49.6	95.5
100388	L 06 K	G 1/4	0	16	40.0	145.1	49.6	95.5

- We recommend our special pneumatic oil on page 145
- If several devices in the »multifix-mini« Series are assembled together, the maximum working pressure is 12 bar.

Accessories / spare parts



Art. No.	Type No.	Description
100367	ZW 05	Mounting bracket
100346	KP 05	Coupler pack for modular assembly of several devices
100383	740/01	Polycarbonate bowl (lubricator)
100392	1233.7.990	Sight dome (polyamide PA)
100393	1233.7.909	Sight dome, metal

Service units

two-piece, »multifix-mini« series

PLUS

Two-piece service units consisting of a diaphragm pressure regulator, independent of inlet pressure, with self-relieving design, combined with a centrifugal separator and a proportional lubricator.

Max. input pressure	12 bar
Control range	0,5 - 10 bar
Pressure gauge display	0 - 16 bar
Max. medium temperature	60 °C
Max. ambient temperature	60 °C
DN	5
Condensate drain	Semi-automatic
Housing	Die-cast zinc
Spring bonnet	POM-brass
Sealant	NBR
Filter rating	5 µm
Flow rate	700 l/min
Flow rate measurement	At P ₁ = 10 bar, P ₂ = 6.3 bar and pressure drop Δ _p = 1 bar

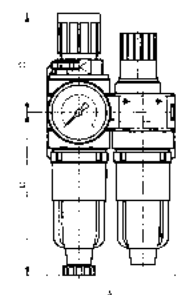

Service unit, 2-piece with polycarbonate bowl and PA sight dome

Art. No.	Type No.	Thread	Size	A mm	B mm	C mm	D mm
100394	CL 05 K-HA	G 1/8	0	80.0	165.5	63.0	102.5
100395	CL 06 K-HA	G 1/4	0	80.0	165.5	63.0	102.5



CL 05 K-HA

- Lockable service units available on request
- If several devices in the »multifix-mini« Series are assembled together, the maximum working pressure is 12 bar.
- We recommend our special pneumatic oil on page 145

Accessories / spare parts

Art. No.	Type No.	Description
100344	MV 30	Mounting bracket with nut M30x1.5
100367	ZW 05	Mounting bracket
100345	R 11-55	Nut M30x1.5
100346	KP 05	Coupler pack for modular assembly of several devices
100357	640/1-HA	Polycarbonate bowl (filter)
100383	740/01	Polycarbonate bowl (lubricator)
100361	KS 11 F-A	Polycarbonate bowl with automatic draining
100134	611.6.905	Filter element 5 µm, Cellpor
100347	22.1805.4	Set of wearing parts
100392	1233.7.990	Sight dome (polyamide PA)
100393	1233.7.909	Sight dome, metal
100362	655.6.900	Automatic drain valve



MV 30 R 11-55



640/1-HA 740/01



KS 11 F-A 611.6.905



22.1805.4 655.6.900

1



Service units

three-piece, »multifix-mini« series

PLUS

Three-piece service units consisting of a diaphragm pressure regulator, independent of inlet pressure, with self-relieving design, combined with a centrifugal separator and a proportional lubricator.

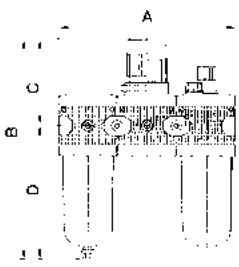

Max. input pressure	12 bar
Control range	0,5 - 10 bar
Pressure gauge display	0 - 16 bar
Max. medium temperature	60 °C
Max. ambient temperature	60 °C
DN	5
Condensate drain	Semi-automatic
Housing	Die-cast zinc
Spring bonnet	POM-brass
Sealant	NBR
Filter rating	5 µm
Flow rate	750 l/min
Flow rate measurement	At P ₁ = 10 bar, P ₂ = 6.3 bar and pressure drop Δ _p = 1 bar



FRL 05 K-HA

Service unit, 3-piece with polycarbonate bowl and PA sight dome

Art. No.	Type No.	Thread	Size	A mm	B mm	C mm	D mm
100398	FRL 05 K-HA	G 1/8	0	120.0	165.5	63.0	102.5
100399	FRL 06 K-HA	G 1/4	0	120.0	165.5	63.0	102.5

- ➔ Service units with metal bowl available online
- ➔ If several devices in the »multifix-mini« Series are assembled together, the maximum working pressure is 12 bar.
- ➔ We recommend our special pneumatic oil on page 145



MV 30

ZW 05



R 11-55

KP 05



640/1-HA

740/01



KS 11 F-A

611.6.905



22.1805.4

1233.7.990

Accessories / spare parts

Art. No.	Type No.	Description
100344	MV 30	Mounting bracket with nut M30x1.5
100367	ZW 05	Mounting bracket
100345	R 11-55	Nut M30x1.5
100346	KP 05	Coupler pack for modular assembly of several devices
100357	640/1-HA	Polycarbonate bowl (filter)
100383	740/01	Polycarbonate bowl (lubricator)
100361	KS 11 F-A	Polycarbonate bowl with automatic draining
100134	611.6.905	Filter element 5 µm, Cellpor
100347	22.1805.4	Set of wearing parts
100392	1233.7.990	Sight dome (polyamide PA)
100393	1233.7.909	Sight dome, metal
100362	655.6.900	Automatic drain valve

Manifold

»multifix-mini« series

PLUS

Narrow, two-way manifold with two G 1/8 outlets.

Max. input pressure	16 bar
Max. medium temperature	60 °C
Max. ambient temperature	60 °C
Housing	Die-cast zinc
Sealant	NBR
Flow rate	P → A 2700 l/min, P → B and P → C 1300 l/min
Flow rate measurement	At P ₁ = 6 bar and pressure drop Δ _p = 1 bar

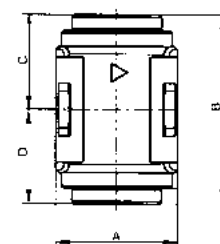
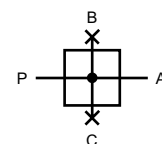

Manifold

Art. No.	Type No.	Thread	Size	A mm	B mm	C mm	D mm
100402	Z 06	G 1/4	0	23.0	36.0	18.0	18.0

→ If several devices in the »multifix-mini« Series are assembled together, the maximum working pressure is 12 bar.



Z 06

Accessories

Art. No.	Type No.	Description
100346	KP 05	Coupler pack for modular assembly of several devices



KP 05

Ball valves (3/2-way)

»multifix-mini« series

PLUS

Rotary switch can be turned 90°, lockable, with relief port including silencer.

Vent port	G 1/4
Max. medium temperature	60 °C
Max. ambient temperature	60 °C
Housing	Die-cast zinc
Operation	Twist knob, rotatable 90°
Sealant	NBR
Flow rate	1800 l/min
Flow rate measurement	At P ₁ = 6 bar and pressure drop Δ _p = 1 bar

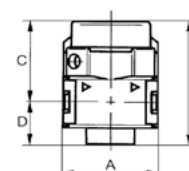
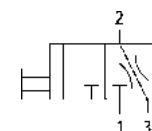

Ball valve (3/2-way)

Art. No.	Type No.	Thread	Size	A mm	B mm	C mm	D mm
100403	K 05	G 1/8	0	40.0	57.6	37.6	20.0
100404	K 06	G 1/4	0	40.0	57.6	37.6	20.0



K 05

→ If several devices in the »multifix-mini« Series are assembled together, the maximum working pressure is 12 bar

Accessories

Art. No.	Type No.	Description
100346	KP 05	Coupler pack for modular assembly of several devices
100367	ZW 05	Mounting bracket
100405	568-2	Silencer



ZW 05



568-2

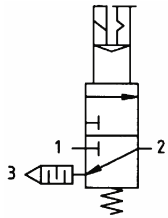

On-off valves (3/2-way valves)

»multifix-mini« series

PLUS

Pneumatic systems or parts of systems can be switched on and off by means of an electrical signal. 3/2-way type including silencer. When they are switched off, the system is relieved at the same time.

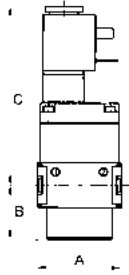

Input pressure	2 - 10 bar
Duty cycle	100 %
Protection IP	IP65 (P 54) acc. to DIN 40050
Electrical connection	Device plug PG 9, type B, EN 175301-803
Vent port	G 1/4
Max. medium temperature	60 °C
Max. ambient temperature	60 °C
Housing	Die-cast zinc
Sealant	NBR
Flow rate	2000 l/min
Flow rate measurement	At P ₁ = 6 bar and pressure drop Δ _p = 1 bar



S 06-4

On-off valve (3/2-way valve)

Art. No.	Type No.	Thread	Size	Solenoid	A mm	B mm	C mm
100406	S 06-2	G 1/4	0	230 V AC, 50 Hz	45.0	29.0	96.0
100408	S 06-4	G 1/4	0	24 V DC	45.0	29.0	96.0

→ If several devices in the »multifix-mini« Series are assembled together, the maximum working pressure is 12 bar.

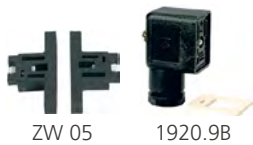

ZW 05

1920.9B



S 11-19N

Accessories / spare parts

Art. No.	Type No.	Description
100346	KP 05	Coupler pack for modular assembly of several devices
100367	ZW 05	Mounting bracket
100405	568-2	Silencer
100409	1920.9B	Coupling socket form B, EN 175301-803
100410	S 11-19N	Replacement solenoid 230 V AC, 50 Hz
100412	S 11-18N	Replacement solenoid 24 V DC

Start-up valve

»multifix-mini« series

PLUS

Seat valves operated by secondary pressure for controlled pressurisation of pneumatic systems. The full cross-section of the regulator is opened at 50% of the input pressure. With adjustable restrictor!

Input pressure	2.5 - 16 bar
Max. medium temperature	60 °C
Max. ambient temperature	60 °C
Housing	Die-cast zinc
Sealant	NBR
Flow rate	2250 l/min
Flow rate measurement	At $P_1 = 6$ bar and pressure drop $\Delta p = 1$ bar

Start-up valve

Art. No.	Type No.	Thread	Size	A mm	B mm	C mm	D mm
100414	A 06	G 1/4	0	45.0	77.5	48.5	29.0

➔ If several devices in the »multifix-mini« Series are assembled together, the maximum working pressure is 12 bar.

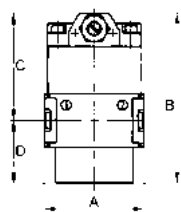
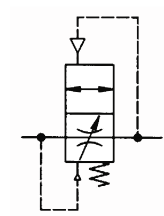

A 06

Accessories

Art. No.	Type No.	Description
100346	KP 05	Coupler pack for modular assembly of several devices
100367	ZW 05	Mounting bracket



KP 05

ZW 05

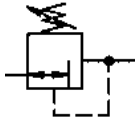

Pressure regulators

»multifix« series

PLUS

Reversible diaphragm pressure regulators, independent of inlet pressure, with self-relieving design. The pressure setting can be locked by pushing the button down.

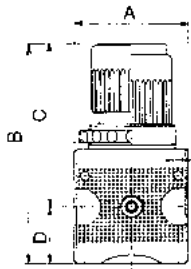

Max. input pressure	16 bar
Max. medium temperature	60 °C
Max. ambient temperature	60 °C
Spring bonnet	POM-brass
Sealant	NBR
Flow rate measurement	At $P_1 = 10$ bar, $P_2 = 6.3$ bar and pressure drop $\Delta p = 1$ bar



R 11 - 10

Pressure regulator, incl. pressure gauge

Art. No.	Type No.	Thread	Size	Housing	Control range bar	Pressure gauge display bar	Flow rate l/min	A mm	B mm	D mm
100415	R 11 - 3	G 1/4	1	Die-cast zinc	0,1 - 3	0 - 4	2100	47.8	94.8	27.8
100416	R 11 - 6	G 1/4	1	Die-cast zinc	0,2 - 6	0 - 10	2100	47.8	94.8	27.8
100417	R 11 - 10	G 1/4	1	Die-cast zinc	0,5 - 10	0 - 16	2100	47.8	94.8	27.8
100418	R 11 - 16	G 1/4	1	Die-cast zinc	0,5 - 16	0 - 25	2100	47.8	94.8	27.8
100419	R 12 - 3	G 3/8	1	Die-cast zinc	0,1 - 3	0 - 4	2100	47.8	94.8	27.8
100420	R 12 - 6	G 3/8	1	Die-cast zinc	0,2 - 6	0 - 10	2100	47.8	94.8	27.8
100421	R 12 - 10	G 3/8	1	Die-cast zinc	0,5 - 10	0 - 16	2100	47.8	94.8	27.8
100422	R 12 - 16	G 3/8	1	Die-cast zinc	0,5 - 16	0 - 25	2100	47.8	94.8	27.8
100423	R 33 - 3	G 1/2	3	Die-cast zinc	0,1 - 3	0 - 4	8700	68.8	134.1	35.1
100424	R 33 - 6	G 1/2	3	Die-cast zinc	0,2 - 6	0 - 10	8700	68.8	134.1	35.1
100425	R 33 - 10	G 1/2	3	Die-cast zinc	0,5 - 10	0 - 16	8700	68.8	134.1	35.1
100426	R 33 - 16	G 1/2	3	Die-cast zinc	0,5 - 16	0 - 25	8700	68.8	134.1	35.1
100427	R 34 - 3	G 3/4	3	Die-cast zinc	0,1 - 3	0 - 4	8700	68.8	134.1	35.1
100428	R 34 - 6	G 3/4	3	Die-cast zinc	0,2 - 6	0 - 10	8700	68.8	134.1	35.1
100429	R 34 - 10	G 3/4	3	Die-cast zinc	0,5 - 10	0 - 16	8700	68.8	134.1	35.1
100430	R 34 - 16	G 3/4	3	Die-cast zinc	0,5 - 16	0 - 25	8700	68.8	134.1	35.1
133097	R 44 - 3	G 3/4	4	Die-cast aluminium	0,1 - 3	0 - 4	12000	85.0	178.0	53.0
133098	R 44 - 6	G 3/4	4	Die-cast aluminium	0,2 - 6	0 - 10	12000	85.0	178.0	53.0
133099	R 44 - 10	G 3/4	4	Die-cast aluminium	0,5 - 10	0 - 16	12000	85.0	178.0	53.0
133100	R 44 - 16	G 3/4	4	Die-cast aluminium	0,5 - 16	0 - 25	12000	85.0	178.0	53.0
133101	R 45 - 3	G 1	4	Die-cast aluminium	0,1 - 3	0 - 4	12000	85.0	178.0	53.0
133102	R 45 - 6	G 1	4	Die-cast aluminium	0,2 - 6	0 - 10	12000	85.0	178.0	53.0
133103	R 45 - 10	G 1	4	Die-cast aluminium	0,5 - 10	0 - 16	12000	85.0	178.0	53.0
133104	R 45 - 16	G 1	4	Die-cast aluminium	0,5 - 16	0 - 25	12000	85.0	178.0	53.0
100431	R 55 - 3	G 1	5	Aluminium	0,1 - 3	0 - 4	17500	100.0	179.5	51.5
100432	R 55 - 6	G 1	5	Aluminium	0,2 - 6	0 - 10	17500	100.0	179.5	51.5
100433	R 55 - 10	G 1	5	Aluminium	0,5 - 10	0 - 16	17500	100.0	179.5	51.5
100434	R 55 - 16	G 1	5	Aluminium	0,5 - 16	0 - 25	17500	100.0	179.5	51.5



R 55 - 10

- ➔ Lockable pressure regulators available on request
- ➔ Internal air consumption (depending on secondary pressure) at size 4 and size 5 (G 3/4 and G 1)

Accessories / spare parts for pressure regulator G 1/4 and G 3/8 (Size 1)

Art. No.	Type No.	Description
100344	MV 30	Mounting bracket with nut M30x1.5
100345	R 11-55	Nut M30x1.5
100435	ZW 11	Mounting bracket with 2 screws
100436	KP 11	Coupler pack for modular assembly of several devices
100437	KP 11 Z	Coupling packet for narrow manifolds
100438	22.1811.4	Set of wearing parts



Accessories / spare parts for pressure regulator G 1/2 and G 3/4 (Size 3)

Art. No.	Type No.	Description
100439	MV 50	Mounting bracket with nut M50x1.5
100440	R 33-55	Nut M50x1.5
100441	ZW 33	Mounting bracket with 2 screws
100442	KP 33	Coupler pack for modular assembly of several devices
100443	KP 33 Z	Coupling packet for narrow manifolds
100444	22.1833.4	Set of wearing parts



Accessories / spare parts for pressure regulator G 3/4 and G 1 (Size 4)

Art. No.	Type No.	Description
135858	ZW 45	Mounting bracket with 2 screws
135857	KP 45	Coupler pack for modular assembly of several devices
135855	22.1845.4	Set of wearing parts



Accessories / spare parts for pressure regulator G 1 (Size 5)

Art. No.	Type No.	Description
100345	R 11-55	Nut M30x1.5
100445	ZW 55	Mounting bracket with 2 screws
100446	KP 55	Coupler pack for modular assembly of several devices
100447	22.1855.4	Set of wearing parts



1

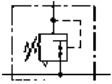

Pressure regulators with continuous pressure supply

»multifix« series

PLUS

Diaphragm pressure regulators with self-relieving design for mounting side by side. The pressure setting can be locked by pushing the button down. By assembling two or more controllers together, it is possible to supply several working air circuits with different output pressures via a single supply line.

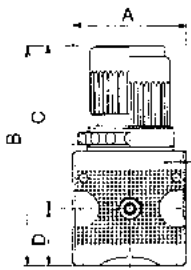

Max. input pressure	16 bar
Max. medium temperature	60 °C
Max. ambient temperature	60 °C
Housing	Die-cast zinc
Spring bonnet	POM-brass
Sealant	NBR
Flow rate measurement	At $P_1 = 10$ bar, $P_2 = 6.3$ bar and pressure drop $\Delta_p = 1$ bar

Pressure regulator with continuous pressure supply, incl. pressure gauge



RB 11-10

Art. No.	Type No.	Thread	Size	Control range bar	Pressure gauge display bar	Flow rate l/min	DN	A mm	B mm	C mm	D mm
100448	RB 11-3	G 1/4	1	0,1 - 3	0 - 4	2250	6	47.8	94.8	67.0	27.8
100449	RB 11-6	G 1/4	1	0,2 - 6	0 - 10	2250	6	47.8	94.8	67.0	27.8
100450	RB 11-10	G 1/4	1	0,5 - 10	0 - 16	2250	6	47.8	94.8	67.0	27.8
100451	RB 33-3	G 1/2	3	0,1 - 3	0 - 4	8500	15	68.8	134.1	99.0	35.1
100452	RB 33-6	G 1/2	3	0,2 - 6	0 - 10	8500	15	68.8	134.1	99.0	35.1
100453	RB 33-10	G 1/2	3	0,5 - 10	0 - 16	8500	15	68.8	134.1	99.0	35.1

- ➔ Lockable pressure regulators available on request
- ➔ The port for the output pressure (P2) is on the rear!



MV 30

R 11-55



ZW 11

KP 11



MV 50

R 33-55



22.1833.4

KP 33

Accessories / spare parts for pressure regulator G 1/4

Art. No.	Type No.	Description
100344	MV 30	Mounting bracket with nut M30x1.5
100345	R 11-55	Nut M30x1.5
100435	ZW 11	Mounting bracket with 2 screws
100436	KP 11	Coupler pack for modular assembly of several devices
100437	KP 11 Z	Coupling packet for narrow manifolds
100438	22.1811.4	Set of wearing parts

Accessories / spare parts for pressure regulator G 1/2

Art. No.	Type No.	Description
100439	MV 50	Mounting bracket with nut M50x1.5
100440	R 33-55	Nut M50x1.5
100441	ZW 33	Mounting bracket with 2 screws
100442	KP 33	Coupler pack for modular assembly of several devices
100443	KP 33 Z	Coupling packet for narrow manifolds
100444	22.1833.4	Set of wearing parts

Precision pressure regulators

»multifix« series

PLUS

Diaphragm pressure regulators, independent of inlet pressure, with self-relieving design and very high flow rate.

The pressure setting can be locked by pushing the button down.

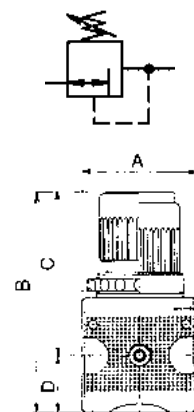

Max. input pressure	16 bar
Max. medium temperature	60 °C
Max. ambient temperature	60 °C
Housing	Die-cast zinc
Spring bonnet	POM-brass
Sealant	NBR
Max. internal air consumption	2.6 l/min (depending on secondary pressure)
Flow rate measurement	At P ₁ = 10 bar, P ₂ = 6.3 bar and pressure drop Δ _p = 1 bar

Precision pressure regulator, incl. pressure gauge

Art. No.	Type No.	Thread	Size	Control range bar	Pressure gauge display bar	Flow rate l/min	DN	A mm	B mm	C mm	D mm
100454	RP 11-3	G 1/4	1	0,1 - 3	0 - 4	2500	6	47.8	94.8	67.0	27.8
100455	RP 11-6	G 1/4	1	0,2 - 6	0 - 10	2500	6	47.8	94.8	67.0	27.8
100456	RP 11-10	G 1/4	1	0,5 - 10	0 - 16	2500	6	47.8	94.8	67.0	27.8
100457	RP 33-3	G 1/2	3	0,1 - 3	0 - 4	7600	15	68.8	134.1	99.0	35.1
100458	RP 33-6	G 1/2	3	0,2 - 6	0 - 10	7600	15	68.8	134.1	99.0	35.1
100459	RP 33-10	G 1/2	3	0,5 - 10	0 - 16	7600	15	68.8	134.1	99.0	35.1



RP 11-10

- ➔ Lockable precision pressure regulators available on request
- ➔ This controller is only allowed to be operated with micro-filtered air (filter rating 0.01 μm).
- ➔ You can find suitable filters on page 66

Accessories / spare parts for precision pressure regulator G 1/4

Art. No.	Type No.	Description
100344	MV 30	Mounting bracket with nut M30x1.5
100345	R 11-55	Nut M30x1.5
100435	ZW 11	Mounting bracket with 2 screws
100436	KP 11	Coupler pack for modular assembly of several devices
100437	KP 11 Z	Coupling packet for narrow manifolds
100460	22.1611.4	Set of wearing parts



Accessories / spare parts for precision pressure regulator G 1/2

Art. No.	Type No.	Description
100439	MV 50	Mounting bracket with nut M50x1.5
100440	R 33-55	Nut M50x1.5
100441	ZW 33	Mounting bracket with 2 screws
100442	KP 33	Coupler pack for modular assembly of several devices
100443	KP 33 Z	Coupling packet for narrow manifolds
100461	22.1633.4	Set of wearing parts



Pressure regulators with pneumatic remote control

»multifix« series

PLUS

Diaphragm pressure regulator, self-relieving, with pneumatic remote control. The pressure is set with a pilot pressure regulator (1:1 ratio). The output pressure corresponds to the set pressure of the pilot pressure regulator. Either a standard or a precision pressure regulator can be used to regulate the pilot pressure.

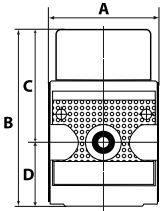
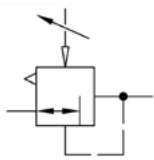

Max. input pressure	16 bar
Max. medium temperature	60 °C
Max. ambient temperature	60 °C
Sealant	NBR
Flow rate measurement	At $P_1 = 10$ bar, $P_2 = 6,3$ bar and pressure drop $\Delta p = 1$ bar

Pressure regulator with pneumatic remote control, without pressure gauge

Art. No.	Type No.	Thread	Size	Pilot air connection	Housing	Flow rate l/min	DN	A mm	B mm	D mm
100462	RI 11	G 1/4	1	G 1/8	Die-cast zinc	2100	6	48.0	75.0	27.0
100463	RI 33	G 1/2	3	G 1/4	Die-cast zinc	8500	15	69.0	94.0	35.0
133105	RI 44	G 3/4	4	G 1/4	Die-cast aluminium	12000	20	85.0	141.0	53.0
133106	RI 45	G 1	4	G 1/4	Die-cast aluminium	12000	25	85.0	141.0	53.0
100464	RI 55	G 1	5	G 1/4	Aluminium	17500	25	100.0	112.0	52.0



RI 11



RI 55



Accessories / spare parts for pressure regulator G 1/4 (Size 1)

Art. No.	Type No.	Description
100435	ZW 11	Mounting bracket with 2 screws
100436	KP 11	Coupler pack for modular assembly of several devices
100465	22.18911.4	Set of wearing parts



Accessories / spare parts for pressure regulator G 1/2 (Size 3)

Art. No.	Type No.	Description
100441	ZW 33	Mounting bracket with 2 screws
100442	KP 33	Coupler pack for modular assembly of several devices
100466	22.18933.4	Set of wearing parts

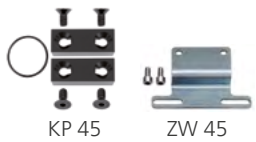

Accessories / spare parts for pressure regulator G 3/4 and G 1 (Size 4)

Art. No.	Type No.	Description
135858	ZW 45	Mounting bracket with 2 screws
135857	KP 45	Coupler pack for modular assembly of several devices
135855	22.1845.4	Set of wearing parts



Accessories / spare parts for pressure regulator G 1 (Size 5)

Art. No.	Type No.	Description
100445	ZW 55	Mounting bracket with 2 screws
100446	KP 55	Coupler pack for modular assembly of several devices
100467	22.18955.4	Set of wearing parts

Filter regulators

»multifix« series

PLUS

Reversible diaphragm pressure regulators, independent of inlet pressure, with self-relieving design, combined with a centrifugal separator.

The pressure setting can be locked by pushing the button down.

Max. medium temperature	60 °C
Max. ambient temperature	60 °C
Max. input pressure	16 bar
Condensate drain	Semi-automatic
Spring bonnet	POM-brass
Sealant	NBR
Flow rate measurement	At $P_1 = 10$ bar, $P_2 = 6,3$ bar and pressure drop $\Delta p = 1$ bar

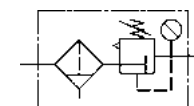

Filter regulator with polycarbonate bowl and pressure gauge

Art. No.	Type No.	Thread	Size	Filter rating μm	Control range bar	Pressure gauge display bar	Flow rate l/min	A mm	B mm	D mm
100468	C 11-K 3-HA	G 1/4	1	5	0,1 - 3	0 - 4	1600	47.8	192.1	125.1
100469	C 11-K 6-HA	G 1/4	1	5	0,2 - 6	0 - 10	1600	47.8	192.1	125.1
100470	C 11-K 10-HA	G 1/4	1	5	0,5 - 10	0 - 16	1600	47.8	192.1	125.1
100471	C 11-K 16-HA	G 1/4	1	5	0,5 - 16	0 - 25	1600	47.8	192.1	125.1
100472	C 12-K 3-HA	G 3/8	1	5	0,1 - 3	0 - 4	1600	47.8	192.1	125.1
100473	C 12-K 6-HA	G 3/8	1	5	0,2 - 6	0 - 10	1600	47.8	192.1	125.1
100474	C 12-K 10-HA	G 3/8	1	5	0,5 - 10	0 - 16	1600	47.8	192.1	125.1
100475	C 12-K 16-HA	G 3/8	1	5	0,5 - 16	0 - 25	1600	47.8	192.1	125.1
100476	C 33-K 3-HA	G 1/2	3	5	0,1 - 3	0 - 4	6700	68.8	246.3	147.3
100477	C 33-K 6-HA	G 1/2	3	5	0,2 - 6	0 - 10	6700	68.8	246.3	147.3
100478	C 33-K 10-HA	G 1/2	3	5	0,5 - 10	0 - 16	6700	68.8	246.3	147.3
100479	C 33-K 16-HA	G 1/2	3	5	0,5 - 16	0 - 25	6700	68.8	246.3	147.3
100480	C 34-K 3-HA	G 3/4	3	5	0,1 - 3	0 - 4	6700	68.8	246.3	147.3
100481	C 34-K 6-HA	G 3/4	3	5	0,2 - 6	0 - 10	6700	68.8	246.3	147.3
100482	C 34-K 10-HA	G 3/4	3	5	0,5 - 10	0 - 16	6700	68.8	246.3	147.3
100483	C 34-K 16-HA	G 3/4	3	5	0,5 - 16	0 - 25	6700	68.8	246.3	147.3
100484	C 55-K 3-HA	G 1	5	40	0,1 - 3	0 - 4	15000	100.0	381.8	253.8
100485	C 55-K 6-HA	G 1	5	40	0,2 - 6	0 - 10	15000	100.0	381.8	253.8
100486	C 55-K 10-HA	G 1	5	40	0,5 - 10	0 - 16	15000	100.0	381.8	253.8
100487	C 55-K 16-HA	G 1	5	40	0,5 - 16	0 - 25	15000	100.0	381.8	253.8



C 11-K 10-HA



C 55-K 10-HA

Filter regulator with polycarbonate bowl, bowl guard and pressure gauge

Art. No.	Type No.	Thread	Size	Filter rating μm	Control range bar	Pressure gauge display bar	Flow rate l/min	A mm	B mm	D mm
100488	C 11 - S	G 1/4	1	5	0,5 - 10	0 - 16	1600	47.8	192.1	125.1
100489	C 12 - S	G 3/8	1	5	0,5 - 10	0 - 16	1600	47.8	192.1	125.1
100490	C 33 - S	G 1/2	3	5	0,5 - 10	0 - 16	6700	68.8	246.3	147.3
100491	C 34 - S	G 3/4	3	5	0,5 - 10	0 - 16	6700	68.8	246.3	147.3
133107	C 44-S 10	G 3/4	4	5	0,5 - 10	0 - 16	12000	85.0	315.0	190.0
133108	C 45-S 10	G 1	4	5	0,5 - 10	0 - 16	12000	85.0	315.0	190.0
100492	C 55 - S	G 1	5	40	0,5 - 10	0 - 16	15000	100.0	381.8	253.8



C 11 - S

- ➔ Lockable filter regulators available on request
- ➔ Filter regulators with bowl guard and metal bowl are also available with control ranges of 0.1 - 3 bar, 0.2 - 6 bar and 0.5 - 16 bar.
Please ask for more information.
- ➔ Internal air consumption (depending on secondary pressure) at size 4 and size 5 (G 3/4 and G 1)

Filter regulators

»multifix« series



MV 30

R 11-55



ZW 11

KP 11



KS 11 F-A

KS 11 F-HA

Accessories / spare parts for filter regulator G 1/4 and G 3/8 (Size 1)

Art. No.	Type No.	Description
100344	MV 30	Mounting bracket with nut M30x1.5
100345	R 11-55	Nut M30x1.5
100435	ZW 11	Mounting bracket with 2 screws
100436	KP 11	Coupler pack for modular assembly of several devices
100437	KP 11 Z	Coupling packet for narrow manifolds
100500	KS 11 F-HA	Polycarbonate bowl with semi-automatic draining
100361	KS 11 F-A	Polycarbonate bowl with automatic draining
100501	SK 11	Bowl guard
100438	22.1811.4	Set of wearing parts
100134	611.6.905	Filter element 5 µm, Cellpor
100362	655.6.900	Automatic drain valve



KP 33

MV 50



655.6.900

SK 33



KS 33 F-HA

KS 33 F-A



ZW 55

655.6.905.2



22.355.4

KP 55

Accessories / spare parts for filter regulator G 1/2 and G 3/4 (Size 3)

Art. No.	Type No.	Description
100439	MV 50	Mounting bracket with nut M50x1.5
100440	R 33-55	Nut M50x1.5
100441	ZW 33	Mounting bracket with 2 screws
100442	KP 33	Coupler pack for modular assembly of several devices
100443	KP 33 Z	Coupling packet for narrow manifolds
100504	KS 33 F-HA	Polycarbonate bowl with semi-automatic draining
100505	KS 33 F-A	Polycarbonate bowl with automatic draining
100506	SK 33	Bowl guard
100444	22.1833.4	Set of wearing parts
100507	633.6.905	Filter element 5 µm, Cellpor
100362	655.6.900	Automatic drain valve
100983	653.6.908	Filter element 8 µm, sintered bronze

Accessories / spare parts for filter regulator G 1 (Size 5)

Art. No.	Type No.	Description
100445	ZW 55	Mounting bracket with 2 screws
100446	KP 55	Coupler pack for modular assembly of several devices
100504	KS 33 F-HA	Polycarbonate bowl with semi-automatic draining
100505	KS 33 F-A	Polycarbonate bowl with automatic draining
100506	SK 33	Bowl guard
205521	655.6.905.2	Filter element 5 µm, Cellpor
100509	22.355.4	Set of wearing parts
100511	655.6.940	Filter element 40 µm, Cellpor
100362	655.6.900	Automatic drain valve

Accessories / spare parts for filter regulator G 3/4 and G 1 (Size 4)

Art. No.	Type No.	Description
135858	ZW 45	Mounting bracket with 2 screws
135857	KP 45	Coupler pack for modular assembly of several devices
135859	KSS 45 F-HA	Polycarbonate bowl, Bowl guard with semi-automatic draining
135860	KSS 45 F-A	Polycarbonate bowl, Bowl guard with fully automatic draining
135855	22.1845.4	Set of wearing parts
100144	6141.6.905	Filter element 5 µm, Cellpor
100362	655.6.900	Automatic drain valve



KSS 45 F-A

6141.6.905

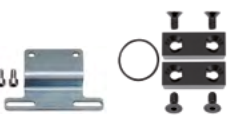

ZW 45

KP 55

Filters

»multifix« series

PLUS

Centrifugal separators with a sintered filter element.

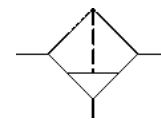

Max. medium temperature	60 °C
Max. ambient temperature	60 °C
Max. input pressure	16 bar
Condensate drain	Semi-automatic
Flow rate measurement	At P ₁ = 6 bar and pressure drop Δp = 1 bar

Filter with polycarbonate bowl

Art. No.	Type No.	Thread	Size	Housing	Filter rating µm	Flow rate l/min	A mm	B mm	D mm
100512	F 11 K-HA	G 1/4	1	Die-cast zinc	5	2000	47.8	152.1	125.1
100513	F 12 K-HA	G 3/8	1	Die-cast zinc	5	2000	47.8	152.1	125.1
100514	F 33 K-HA	G 1/2	3	Die-cast zinc	5	5850	68.8	181.8	147.3
100515	F 34 K-HA	G 3/4	3	Die-cast zinc	5	5850	68.8	181.8	147.3
100516	F 55 K-HA	G 1	5	Aluminium	40	10500	100.0	305.8	253.8



F 11 K-HA

Filter with polycarbonate bowl and bowl guard

Art. No.	Type No.	Thread	Size	Housing	Filter rating µm	Flow rate l/min	A mm	B mm	D mm
100517	F 11 S	G 1/4	1	Die-cast zinc	5	2000	47.8	152.1	125.1
100518	F 12 S	G 3/8	1	Die-cast zinc	5	2000	47.8	152.1	125.1
100519	F 33 S	G 1/2	3	Die-cast zinc	5	5850	68.8	181.8	147.3
100520	F 34 S	G 3/4	3	Die-cast zinc	5	5850	68.8	181.8	147.3
133111	F 44 S	G 3/4	4	Die-cast aluminium	5	8000	85.0	243.0	190.0
133112	F 45 S	G 1	4	Die-cast aluminium	5	8000	85.0	243.0	190.0
100521	F 55 S	G 1	5	Aluminium	40	10500	100.0	305.8	253.8



F 11 S

Accessories / spare parts for filter G 1/4 and G 3/8 (Size 1)

Art. No.	Type No.	Description
100435	ZW 11	Mounting bracket with 2 screws
100436	KP 11	Coupler pack for modular assembly of several devices
100437	KP 11 Z	Coupling packet for narrow manifolds
100500	KS 11 F-HA	Polycarbonate bowl with semi-automatic draining
100361	KS 11 F-A	Polycarbonate bowl with automatic draining
100501	SK 11	Bowl guard
100134	611.6.905	Filter element 5 µm, Cellpor
100362	655.6.900	Automatic drain valve



Accessories / spare parts for filter G 1/2 and G 3/4 (Size 3)

Art. No.	Type No.	Description
100441	ZW 33	Mounting bracket with 2 screws
100442	KP 33	Coupler pack for modular assembly of several devices
100443	KP 33 Z	Coupling packet for narrow manifolds
100504	KS 33 F-HA	Polycarbonate bowl with semi-automatic draining
100505	KS 33 F-A	Polycarbonate bowl with automatic draining
100506	SK 33	Bowl guard
100507	633.6.905	Filter element 5 µm, Cellpor
100362	655.6.900	Automatic drain valve



Accessories / spare parts for filter G 1 (Size 5)

Art. No.	Type No.	Description
100445	ZW 55	Mounting bracket with 2 screws
100446	KP 55	Coupler pack for modular assembly of several devices
100504	KS 33 F-HA	Polycarbonate bowl with semi-automatic draining
100505	KS 33 F-A	Polycarbonate bowl with automatic draining
100506	SK 33	Bowl guard



1



655.6.905.2 655.6.940



ZW 45 KP 45



KSS 45 F-HA KSS 45 F-A

Accessories / spare parts for filter G 1 (Size 5)

Art. No.	Type No.	Description
205521	655.6.905.2	Filter element 5 µm, Cellpor
100511	655.6.940	Filter element 40 µm, Cellpor
100362	655.6.900	Automatic drain valve

Accessories / spare parts for filter G 3/4 and G 1 (Size 4)

Art. No.	Type No.	Description
135858	ZW 45	Mounting bracket with 2 screws
135857	KP 45	Coupler pack for modular assembly of several devices
135859	KSS 45 F-HA	Polycarbonate bowl, Bowl guard with semi-automatic draining
135860	KSS 45 F-A	Polycarbonate bowl, Bowl guard with fully automatic draining
100144	6141.6.905	Filter element 5 µm, Cellpor
100362	655.6.900	Automatic drain valve

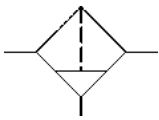

Pre-filters

»multifix« series

PLUS

For filtering out solid impurities larger than 0.3 µm.

Max. input pressure	16 bar
Max. medium temperature	60 °C
Max. ambient temperature	60 °C
Condensate drain	Semi-automatic
Sealant	NBR
Flow rate measurement	At P ₁ = 6 bar and pressure drop Δ _p = 0.02 bar
Filter rating	0.3 µm
Efficiency	99.999 %
Filter element	Paper-POM

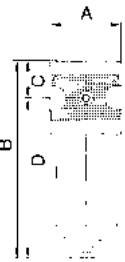

FV 33 K-HA

Pre-filter with polycarbonate bowl

Art. No.	Type No.	Thread	Size	Housing	Flow rate l/min	DN	A mm	B mm	C mm	D mm
100527	FV 11 K-HA	G 1/4	1	Die-cast zinc	160	6	47.8	152.1	27.0	125.1
100528	FV 33 K-HA	G 1/2	3	Die-cast zinc	500	15	68.8	185.8	38.5	147.3



FV 33 S FV 44 S

Pre-filter with polycarbonate bowl and bowl guard

Art. No.	Type No.	Thread	Size	Housing	Flow rate l/min	DN	A mm	B mm	C mm	D mm
100529	FV 11 S	G 1/4	1	Die-cast zinc	160	6	47.8	152.1	27.0	125.1
100530	FV 33 S	G 1/2	3	Die-cast zinc	500	15	68.8	185.8	38.5	147.3
133115	FV 44 S	G 3/4	4	Die-cast aluminium	2000	20	85.0	248.0	58.0	190.0
133116	FV 45 S	G 1	4	Die-cast aluminium	2000	25	85.0	248.0	58.0	190.0



ZW 11 KS 11 F-HA

Accessories / spare parts for pre-filter G 1/4

Art. No.	Type No.	Description
100435	ZW 11	Mounting bracket with 2 screws
100436	KP 11	Coupler pack for modular assembly of several devices
100437	KP 11 Z	Coupling packet for narrow manifolds
100500	KS 11 F-HA	Polycarbonate bowl with semi-automatic draining

Accessories / spare parts for pre-filter G 1/4

Art. No.	Type No.	Description
100362	655.6.900	Automatic drain valve
100169	V 23/40	Filter element (paper-POM) – automatic drain valve



Accessories / spare parts for pre-filter G 1/2

Art. No.	Type No.	Description
100441	ZW 33	Mounting bracket with 2 screws
100442	KP 33	Coupler pack for modular assembly of several devices
100443	KP 33 Z	Coupling packet for narrow manifolds
100504	KS 33 F-HA	Polycarbonate bowl with semi-automatic draining
100172	DM 34	Differential pressure gauge
100171	DAF 1	Differential pressure indicator
100362	655.6.900	Automatic drain valve
100545	V 38/60	Pre-filter element (paper-aluminium)



Accessories / spare parts for pre-filter G 3/4 and G 1

Art. No.	Type No.	Description
135858	ZW 45	Mounting bracket with 2 screws
135857	KP 45	Coupler pack for modular assembly of several devices
135859	KSS 45 F-HA	Polycarbonate bowl, Bowl guard with semi-automatic draining
135860	KSS 45 F-A	Polycarbonate bowl, Bowl guard with fully automatic draining
100174	V 864/04	Filter element (paper-aluminium)
100362	655.6.900	Automatic drain valve



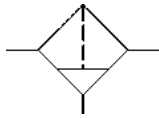

FM 11 K-HA



FM 45 S



655.6.900 KS 11 F-HA



KP 11 M 23/41



DAF 1 DM 34



KS 33 F-HA M 38/60



KSS 45 F-A M 884/02

Micro-filters (fine-filters)

»multifix« series

PLUS

For filtering out solid impurities larger than 0.01 µm.

Max. input pressure	16 bar
Max. medium temperature	60 °C
Max. ambient temperature	60 °C
Condensate drain	Semi-automatic
Sealant	NBR
Flow rate measurement	At P ₁ = 6 bar and pressure drop Δ _p = 0.1 bar
Filter rating	0.01 µm
Efficiency	99.999 %
Filter element	Borosilicate-POM
Residual oil content	0.01 mg/m ³

Micro-filter with polycarbonate bowl

Art. No.	Type No.	Thread	Size	Housing	Flow rate l/min	DN	A mm	B mm	C mm	D mm
100533	FM 11 K-HA	G 1/4	1	Die-cast zinc	280	6	47.8	152.1	27.0	125.1
100534	FM 33 K-HA	G 1/2	3	Die-cast zinc	720	15	68.8	185.8	38.5	147.3

Micro-filter with polycarbonate bowl and bowl guard

Art. No.	Type No.	Thread	Size	Housing	Flow rate l/min	DN	A mm	B mm	C mm	D mm
100535	FM 11 S	G 1/4	1	Die-cast zinc	280	6	47.8	152.1	27.0	125.1
100536	FM 33 S	G 1/2	3	Die-cast zinc	720	15	68.8	185.8	38.5	147.3
133145	FM 44 S	G 3/4	4	Die-cast aluminium	1500	20	85.0	248.0	58.0	190.0
133146	FM 45 S	G 1	4	Die-cast aluminium	1500	25	85.0	248.0	58.0	190.0

Accessories / spare parts for micro-filter G 1/4

Art. No.	Type No.	Description
100435	ZW 11	Mounting bracket with 2 screws
100436	KP 11	Coupler pack for modular assembly of several devices
100437	KP 11 Z	Coupling packet for narrow manifolds
100500	KS 11 F-HA	Polycarbonate bowl with semi-automatic draining
100362	655.6.900	Automatic drain valve
100187	M 23/70	Filter element (borosilicate-POM) – semi-autom. drain valve
100188	M 23/41	Filter element (borosilicate-POM) – automatic drain valve

Accessories / spare parts for micro-filter G 1/2

Art. No.	Type No.	Description
100441	ZW 33	Mounting bracket with 2 screws
100442	KP 33	Coupler pack for modular assembly of several devices
100443	KP 33 Z	Coupling packet for narrow manifolds
100504	KS 33 F-HA	Polycarbonate bowl with semi-automatic draining
100172	DM 34	Differential pressure gauge
100171	DAF 1	Differential pressure indicator
100362	655.6.900	Automatic drain valve
100546	M 38/60	Micro-filter element (borosilicate-aluminium)

Accessories / spare parts for micro-filter G 3/4 and G 1

Art. No.	Type No.	Description
135858	ZW 45	Mounting bracket with 2 screws
135857	KP 45	Coupler pack for modular assembly of several devices
135859	KSS 45 F-HA	Polycarbonate bowl, Bowl guard with semi-automatic draining
135860	KSS 45 F-A	Polycarbonate bowl, Bowl guard with fully automatic draining
100190	M 884/02	Filter element (borosilicate-aluminium)
100362	655.6.900	Automatic drain valve

Activated carbon filters

»multifix« series

PLUS

For filtering odours out of compressed air.

The activated carbon absorbs the oil vapour molecules contained in the compressed air. A separate filter route prevents activated carbon particles from entering the air flow.

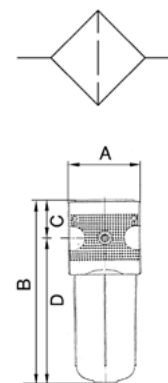

Max. input pressure	16 bar
Max. medium temperature	60 °C
Max. ambient temperature	60 °C
Sealant	NBR
Flow rate measurement	At P ₁ = 6 bar and pressure drop Δ _p = 0.2 bar
Residual oil content	0.005 mg/m ³
Filter element	Activated carbon-POM

Activated carbon filter with polycarbonate bowl

Art. No.	Type No.	Thread	Size	Housing	Flow rate l/min	DN	A mm	B mm	C mm	D mm
100539	FA 11 K	G 1/4	1	Die-cast zinc	380	6	47.8	136.8	27.0	109.8
100540	FA 33 K	G 1/2	3	Die-cast zinc	1500	15	68.8	166.6	34.5	132.1



FA 33 K

Activated carbon filter with polycarbonate bowl and bowl guard

Art. No.	Type No.	Thread	Size	Housing	Flow rate l/min	DN	A mm	B mm	C mm	D mm
100541	FA 11 S	G 1/4	1	Die-cast zinc	380	6	47.8	136.8	27.0	109.8
100542	FA 33 S	G 1/2	3	Die-cast zinc	1500	15	68.8	167.0	34.5	132.5
133149	FA 44 S	G 3/4	4	Die-cast aluminium	3000	20	85.0	241.0	58.0	183.0
133150	FA 45 S	G 1	4	Die-cast aluminium	3000	25	85.0	241.0	58.0	183.0



FM 45 S

Accessories / spare parts for activated carbon filter G 1/4

Art. No.	Type No.	Description
100435	ZW 11	Mounting bracket with 2 screws
100436	KP 11	Coupler pack for modular assembly of several devices
100437	KP 11 Z	Coupling packet for narrow manifolds
100385	KS 11 N	Polycarbonate bowl for lubricator
100386	A 23/80	Filter element (activated carbon POM)



KS 11 N



A 23/80

Accessories / spare parts for activated carbon filter G 1/2

Art. No.	Type No.	Description
100441	ZW 33	Mounting bracket with 2 screws
100442	KP 33	Coupler pack for modular assembly of several devices
100443	KP 33 Z	Coupling packet for narrow manifolds
100548	KS 33 N	Polycarbonate bowl for lubricator
100550	A 38/90	Activated carbon element (body from aluminium)



A 38/90



KP 33

Accessories / spare parts for activated carbon filter G 3/4 and G 1

Art. No.	Type No.	Description
135858	ZW 45	Mounting bracket with 2 screws
135857	KP 45	Coupler pack for modular assembly of several devices
135863	KSS 45 NS	Polycarbonate bowl, without drain valve
100205	A 896	Filter element (activated carbon)
100362	655.6.900	Automatic drain valve



ZW 45

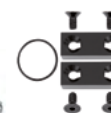

KP 45



KSS 45 NS



655.6.900

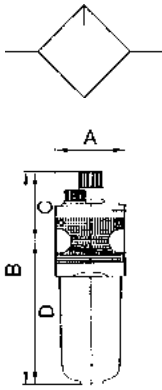

Oil-mist lubricators

»multifix« series

PLUS

Proportional lubricators, oil can be filled under pressure.

Max. medium temperature	60 °C
Max. ambient temperature	60 °C
Sealant	NBR
Oil grade	CL 32 acc. to DIN 51517-ISO VG 32
Flow rate measurement	At $P_1 = 6$ bar and pressure drop $\Delta p = 1$ bar



Oil-mist lubricator with polycarbonate bowl and PA sight dome

Art. No.	Type No.	Thread	Size	Max. input pressure bar	Housing	Flow rate l/min	A mm	B mm	D mm
100551	L 11 K	G 1/4	1	16	Die-cast zinc	1900	47.8	167.8	109.8
100552	L 12 K	G 3/8	1	16	Die-cast zinc	1900	47.8	167.8	109.8
100553	L 33 K	G 1/2	3	16	Die-cast zinc	5000	68.8	198.2	132.1
100554	L 34 K	G 3/4	3	16	Die-cast zinc	5000	68.8	198.2	132.1
100555	L 55 K	G 1	5	16	Aluminium	19000	100.0	324.3	241.6

Oil-mist lubricator with polycarbonate bowl and bowl guard, PA sight dome

Art. No.	Type No.	Thread	Size	Max. input pressure bar	Housing	Flow rate l/min	A mm	B mm	D mm
100556	L 11 S	G 1/4	1	16	Die-cast zinc	1900	47.8	167.8	109.8
100557	L 12 S	G 3/8	1	16	Die-cast zinc	1900	47.8	167.8	109.8
100558	L 33 S	G 1/2	3	16	Die-cast zinc	5000	68.8	198.6	132.5
100559	L 34 S	G 3/4	3	16	Die-cast zinc	5000	68.8	198.6	132.5
133119	L 44 S	G 3/4	4	16	Die-cast aluminium	14000	85.0	268.0	182.0
133120	L 45 S	G 1	4	16	Die-cast aluminium	14000	85.0	268.0	182.0
100560	L 55 S	G 1	5	16	Aluminium	19000	100.0	324.3	241.6

→ We recommend our special pneumatic oil on page 145



Accessories / spare parts for oil-mist lubricator G 1/4 and G 3/8 (Size 1)

Art. No.	Type No.	Description
100435	ZW 11	Mounting bracket with 2 screws
100436	KP 11	Coupler pack for modular assembly of several devices
100437	KP 11 Z	Coupling packet for narrow manifolds
100385	KS 11 N	Polycarbonate bowl for lubricator
100501	SK 11	Bowl guard
100392	1233.7.990	Sight dome (polyamide PA)
100393	1233.7.909	Sight dome, metal

Accessories / spare parts for oil-mist lubricator G 1/2 and G 3/4 (Size 3)

Art. No.	Type No.	Description
100441	ZW 33	Mounting bracket with 2 screws
100442	KP 33	Coupler pack for modular assembly of several devices
100443	KP 33 Z	Coupling packet for narrow manifolds
100548	KS 33 N	Polycarbonate bowl for lubricator
100506	SK 33	Bowl guard
100392	1233.7.990	Sight dome (polyamide PA)
100393	1233.7.909	Sight dome, metal

Accessories / spare parts for oil-mist lubricator G 1 (Size 5)

Art. No.	Type No.	Description
100445	ZW 55	Mounting bracket with 2 screws
100446	KP 55	Coupler pack for modular assembly of several devices
100548	KS 33 N	Polycarbonate bowl for lubricator
100506	SK 33	Bowl guard
100392	1233.7.990	Sight dome (polyamide PA)
100393	1233.7.909	Sight dome, metal

Accessories / spare parts for oil-mist lubricator G 3/4 and G 1 (Size 4)

Art. No.	Type No.	Description
135858	ZW 45	Mounting bracket with 2 screws
135857	KP 45	Coupler pack for modular assembly of several devices
135863	KSS 45 NS	Polycarbonate bowl, without drain valve
100392	1233.7.990	Sight dome (polyamide PA)
100393	1233.7.909	Sight dome, metal



Service units

two-piece, »multifix« series

PLUS

Two-piece service units consisting of a reversible diaphragm pressure regulator, independent of inlet pressure, with self-relieving design, combined with a centrifugal separator and a proportional lubricator.

Control range	0,5 - 10 bar
Pressure gauge display	0 - 16 bar
Max. input pressure	16 bar
Max. medium temperature	60 °C
Max. ambient temperature	60 °C
Condensate drain	Semi-automatic
Spring bonnet	POM-brass
Sealant	NBR
Flow rate measurement	At $P_1 = 10$ bar, $P_2 = 6,3$ bar and pressure drop $\Delta p = 1$ bar

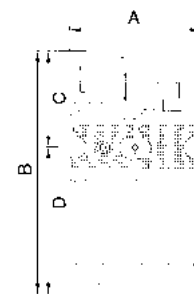
**Service unit, 2-piece with polycarbonate bowl and PA sight dome**

Art. No.	Type No.	Thread	Size	Housing	Filter rating μm	Flow rate l/min	A mm	B mm	D mm
100566	CL 11 K-HA	G 1/4	1	Die-cast zinc	5	1200	92.8	192.1	125.1
100567	CL 12 K-HA	G 3/8	1	Die-cast zinc	5	1200	92.8	192.1	125.1
100568	CL 33 K-HA	G 1/2	3	Die-cast zinc	5	5800	134.8	246.3	147.3
100569	CL 34 K-HA	G 3/4	3	Die-cast zinc	5	5800	134.8	246.3	147.3
100570	CL 55 K-HA	G 1	5	Aluminium	40	13500	200.0	381.8	253.8



CL 11 K-HA

Service unit, 2-piece with polycarbonate bowl and bowl guard, PA sight dome

Art. No.	Type No.	Thread	Size	Housing	Filter rating μm	Flow rate l/min	A mm	B mm	D mm
100571	CL 11 S	G 1/4	1	Die-cast zinc	5	1200	92.8	192.1	125.1
100572	CL 12 S	G 3/8	1	Die-cast zinc	5	1200	92.8	192.1	125.1
100573	CL 33 S	G 1/2	3	Die-cast zinc	5	5800	134.8	246.3	147.3
100574	CL 34 S	G 3/4	3	Die-cast zinc	5	5800	134.8	246.3	147.3
133123	CL 44 S-10	G 3/4	4	Die-cast aluminium	5	12000	170.0	315.0	190.0
133124	CL 45 S-10	G 1	4	Die-cast aluminium	5	12000	170.0	315.0	190.0
100575	CL 55 S	G 1	5	Aluminium	40	13500	200.0	381.8	253.8



CL 11 S

- 2-piece service units are also available in other control ranges (0.1 - 3 bar, 0.2 - 6 bar and 0.5 - 16 bar) and in lockable version. Please ask for more information.
- Internal air consumption (depending on secondary pressure) at size 4 and size 5 (G 3/4 and G 1)
- We recommend our special pneumatic oil on page 145

Accessories / spare parts for service unit G 1/4 and G 3/8 (Size 1)

Art. No.	Type No.	Description
100344	MV 30	Mounting bracket with nut M30x1.5
100345	R 11-55	Nut M30x1.5
100435	ZW 11	Mounting bracket with 2 screws
100436	KP 11	Coupler pack for modular assembly of several devices
100437	KP 11 Z	Coupling packet for narrow manifolds



MV 30

R 11-55

1



Accessories / spare parts for service unit G 1/4 and G 3/8 (Size 1)		
Art. No.	Type No.	Description
100500	KS 11 F-HA	Polycarbonate bowl with semi-automatic draining
100361	KS 11 F-A	Polycarbonate bowl with automatic draining
100385	KS 11 N	Polycarbonate bowl for lubricator
100501	SK 11	Bowl guard
100392	1233.7.990	Sight dome (polyamide PA)
100393	1233.7.909	Sight dome, metal
100134	611.6.905	Filter element 5 µm, Cellpor
100438	22.1811.4	Set of wearing parts
100362	655.6.900	Automatic drain valve



Accessories / spare parts for service unit G 1/2 and G 3/4 (Size 3)		
Art. No.	Type No.	Description
100439	MV 50	Mounting bracket with nut M50x1.5
100440	R 33-55	Nut M50x1.5
100441	ZW 33	Mounting bracket with 2 screws
100442	KP 33	Coupler pack for modular assembly of several devices
100443	KP 33 Z	Coupling packet for narrow manifolds
100504	KS 33 F-HA	Polycarbonate bowl with semi-automatic draining
100505	KS 33 F-A	Polycarbonate bowl with automatic draining
100548	KS 33 N	Polycarbonate bowl for lubricator
100506	SK 33	Bowl guard
100392	1233.7.990	Sight dome (polyamide PA)
100393	1233.7.909	Sight dome, metal
100507	633.6.905	Filter element 5 µm, Cellpor
100362	655.6.900	Automatic drain valve
100444	22.1833.4	Set of wearing parts



Accessories / spare parts for service unit G 1 (Size 5)		
Art. No.	Type No.	Description
100445	ZW 55	Mounting bracket with 2 screws
100446	KP 55	Coupler pack for modular assembly of several devices
100504	KS 33 F-HA	Polycarbonate bowl with semi-automatic draining
100505	KS 33 F-A	Polycarbonate bowl with automatic draining
100548	KS 33 N	Polycarbonate bowl for lubricator
100506	SK 33	Bowl guard
205521	655.6.905.2	Filter element 5 µm, Cellpor
100392	1233.7.990	Sight dome (polyamide PA)
100393	1233.7.909	Sight dome, metal
100511	655.6.940	Filter element 40 µm, Cellpor
100362	655.6.900	Automatic drain valve
100447	22.1855.4	Set of wearing parts
100509	22.355.4	Set of wearing parts



Accessories / spare parts for service unit G 3/4 and G 1 (Size 4)		
Art. No.	Type No.	Description
135858	ZW 45	Mounting bracket with 2 screws
135857	KP 45	Coupler pack for modular assembly of several devices
135859	KSS 45 F-HA	Polycarbonate bowl, Bowl guard with semi-automatic draining
135860	KSS 45 F-A	Polycarbonate bowl, Bowl guard with fully automatic draining
135863	KSS 45 NS	Polycarbonate bowl, without drain valve
135855	22.1845.4	Set of wearing parts
100144	6141.6.905	Filter element 5 µm, Cellpor
100362	655.6.900	Automatic drain valve
100392	1233.7.990	Sight dome (polyamide PA)
100393	1233.7.909	Sight dome, metal

Service units

three-piece, »multifix« series

PLUS

Three-piece service units consisting of a reversible diaphragm pressure regulator, independent of inlet pressure, with self-relieving design, centrifugal separator and proportional lubricator.

Control range	0,5 - 10 bar
Pressure gauge display	0 - 16 bar
Max. input pressure	16 bar
Max. medium temperature	60 °C
Max. ambient temperature	60 °C
Condensate drain	Semi-automatic
Spring bonnet	POM-brass
Sealant	NBR
Flow rate measurement	At $P_1 = 10$ bar, $P_2 = 6,3$ bar and pressure drop $\Delta p = 1$ bar

Service unit, 3-piece with polycarbonate bowl and PA sight dome

Art. No.	Type No.	Thread	Size	Housing	Filter rating μm	Flow rate l/min	A mm	B mm	D mm
100581	FRL 11 K-HA	G 1/4	1	Die-cast zinc	5	1200	137.8	192.1	125.1
100582	FRL 12 K-HA	G 3/8	1	Die-cast zinc	5	1200	137.8	192.1	125.1
100583	FRL 33 K-HA	G 1/2	3	Die-cast zinc	5	5800	200.8	246.3	147.3
100584	FRL 34 K-HA	G 3/4	3	Die-cast zinc	5	5800	200.8	246.3	147.3
100585	FRL 55 K-HA	G 1	5	Aluminium	40	13500	300.0	381.8	253.8

Service unit, 3-piece with polycarbonate bowl and bowl guard, PA sight dome

Art. No.	Type No.	Thread	Size	Housing	Filter rating μm	Flow rate l/min	A mm	B mm	D mm
100586	FRL 11 S	G 1/4	1	Die-cast zinc	5	1200	137.8	192.1	125.1
100587	FRL 12 S	G 3/8	1	Die-cast zinc	5	1200	137.8	192.1	125.1
100588	FRL 33 S	G 1/2	3	Die-cast zinc	5	5800	200.8	246.3	147.3
100589	FRL 34 S	G 3/4	3	Die-cast zinc	5	5800	200.8	246.3	147.3
133127	FRL 44 S-10	G 3/4	4	Die-cast aluminium	5	12000	255.0	315.0	190.0
133128	FRL 45 S-10	G 1	4	Die-cast aluminium	5	12000	255.0	315.0	190.0
100590	FRL 55 S	G 1	5	Aluminium	40	13500	300.0	381.8	253.8

- 3-piece service units are also available in other control ranges (0.1 - 3 bar, 0.2 - 6 bar and 0.5 - 16 bar) and in lockable version. Please ask for more information.
- Internal air consumption (depending on secondary pressure) at size 4 and size 5 (G 3/4 and G 1)
- We recommend our special pneumatic oil on page 145

Accessories / spare parts for service unit G 1/4 and G 3/8 (Size 1)

Art. No.	Type No.	Description
100344	MV 30	Mounting bracket with nut M30x1.5
100345	R 11-55	Nut M30x1.5
100435	ZW 11	Mounting bracket with 2 screws
100436	KP 11	Coupler pack for modular assembly of several devices
100437	KP 11 Z	Coupling packet for narrow manifolds
100500	KS 11 F-HA	Polycarbonate bowl with semi-automatic draining
100361	KS 11 F-A	Polycarbonate bowl with automatic draining
100385	KS 11 N	Polycarbonate bowl for lubricator
100501	SK 11	Bowl guard
100392	1233.7.990	Sight dome (polyamide PA)
100393	1233.7.909	Sight dome, metal
100134	611.6.905	Filter element 5 μm , Cellpor
100438	22.1811.4	Set of wearing parts
100362	655.6.900	Automatic drain valve

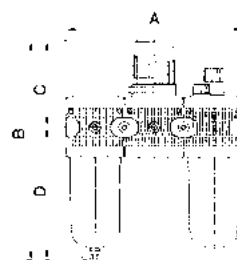
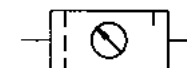

FRL 11 K-HA



FRL 11 S



MV 30

R 11-55



ZW 11

KP 11



KS 11 F-A

KS 11 F-HA

1



Accessories / spare parts for service unit G 1/2 and G 3/4 (Size 3)

Art. No.	Type No.	Description
100439	MV 50	Mounting bracket with nut M50x1.5
100440	R 33-55	Nut M50x1.5
100441	ZW 33	Mounting bracket with 2 screws
100442	KP 33	Coupler pack for modular assembly of several devices
100443	KP 33 Z	Coupling packet for narrow manifolds
100504	KS 33 F-HA	Polycarbonate bowl with semi-automatic draining
100505	KS 33 F-A	Polycarbonate bowl with automatic draining
100548	KS 33 N	Polycarbonate bowl for lubricator
100506	SK 33	Bowl guard
100392	1233.7.990	Sight dome (polyamide PA)
100393	1233.7.909	Sight dome, metal
100507	633.6.905	Filter element 5 µm, Cellpor
100362	655.6.900	Automatic drain valve
100444	22.1833.4	Set of wearing parts



Accessories / spare parts for service unit G 1 (Size 5)

Art. No.	Type No.	Description
100445	ZW 55	Mounting bracket with 2 screws
100446	KP 55	Coupler pack for modular assembly of several devices
100504	KS 33 F-HA	Polycarbonate bowl with semi-automatic draining
100505	KS 33 F-A	Polycarbonate bowl with automatic draining
100548	KS 33 N	Polycarbonate bowl for lubricator
100506	SK 33	Bowl guard
205521	655.6.905.2	Filter element 5 µm, Cellpor
100392	1233.7.990	Sight dome (polyamide PA)
100393	1233.7.909	Sight dome, metal
100511	655.6.940	Filter element 40 µm, Cellpor
100362	655.6.900	Automatic drain valve
100447	22.1855.4	Set of wearing parts
100509	22.355.4	Set of wearing parts



Accessories / spare parts for service unit G 3/4 and G 1 (Size 4)

Art. No.	Type No.	Description
135858	ZW 45	Mounting bracket with 2 screws
135857	KP 45	Coupler pack for modular assembly of several devices
135859	KSS 45 F-HA	Polycarbonate bowl, Bowl guard with semi-automatic draining
135860	KSS 45 F-A	Polycarbonate bowl, Bowl guard with fully automatic draining
135863	KSS 45 NS	Polycarbonate bowl, without drain valve
135855	22.1845.4	Set of wearing parts
100144	6141.6.905	Filter element 5 µm, Cellpor
100362	655.6.900	Automatic drain valve
100392	1233.7.990	Sight dome (polyamide PA)
100393	1233.7.909	Sight dome, metal

SAFETY service unit sets

»multifix« series

PLUS

These compressed air service unit sets, comprising a ball valve with silencer, a start-up valve and one out of a pressure regulator, filter regulator or service unit, meet even the strictest requirements for operating reliability and accident prevention!

Input pressure	2 - 16 bar
Control range	2 - 10 bar
Pressure gauge display	0 - 16 bar
Max. temperature range	60 °C
Medium	Compressed air
Housing	Die-cast zinc
Spring bonnet	POM
Sealant	NBR
Diaphragms	NBR
Filter element	Cellpor (PE)
Filter rating	5 µm
Vent port	Silencer (ball valve)
Flow rate measurement	At $P_1 = 8$ bar, $P_2 = 6$ bar and pressure drop $\Delta p = 1$ bar

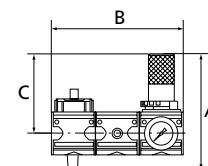

WS 1001 + VS 37

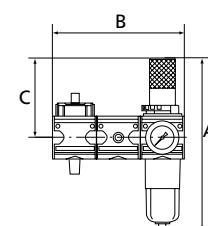

WS 2001 + VS 37

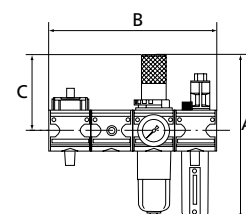

WS 3001 + VS 37

SAFETY service unit set, comprising a ball valve with silencer, start-up valve and pressure regulator with lock cylinder

Art. No.	Type No.	Thread	Size	Flow rate l/min	A mm	B mm	C mm
100596	WS 1001	G 1/4	1	1000	128.0	137.8	94.0
100597	WS 1002	G 1/2	3	4000	189.0	200.8	122.0
100598	WS 1003	G 1	5	12000	241.7	282.8	157.0

SAFETY service unit set, comprising a ball valve with silencer, start-up valve and filter regulator with polycarbonate bowl and bowl guard with lock cylinder

Art. No.	Type No.	Thread	Size	Condensate drain	Flow rate l/min	A mm	B mm	C mm
100599	WS 2001	G 1/4	1	Semi-automatic	1000	219.1	137.8	94.0
100600	WS 2002	G 1/2	3	Semi-automatic	4000	269.3	200.8	122.0
100601	WS 2003	G 1	5	Semi-automatic	12000	410.8	282.8	157.0

SAFETY service unit set, comprising a ball valve with silencer, start-up valve and 2-piece service unit with polycarbonate bowl and bowl guard with lock cylinder

Art. No.	Type No.	Thread	Size	Condensate drain	Flow rate l/min	A mm	B mm	C mm
100602	WS 3001	G 1/4	1	Semi-automatic	1000	219.1	182.8	94.0
100603	WS 3002	G 1/2	3	Semi-automatic	3550	269.3	266.8	122.0
100604	WS 3003	G 1	5	Semi-automatic	9800	410.8	382.8	157.0

- For accessories and spare parts, refer to individual components: ball valve, start-up valve, pressure regulator, filter regulator, 2-piece service unit.
- The price does not include a padlock. Please order separately.
- Internal air consumption (depending on secondary pressure) at size 5 (G 1)

Accessories

Art. No.	Type No.	Description
100273	VS 37	Padlock, band Ø 6 mm



VS 37

1

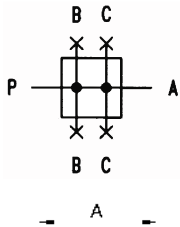

Manifolds

»multifix« series

PLUS

Wide or narrow, four-way manifolds.

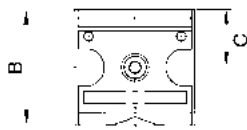

Max. input pressure	16 bar
Max. medium temperature	60 °C
Max. ambient temperature	60 °C
Sealant	NBR
Flow rate measurement	At $P_1 = 6$ bar and pressure drop $\Delta p = 1$ bar



Z 11



T 11

Manifold - narrow design

Art. No.	Type No.	Thread	Size	Outlet	Housing	Flow rate l/min	A mm	B mm	C mm
100605	Z 11	G 1/4	1	3 x 1/4, 1 x 1/8	Die-cast zinc	3300	34.8	52.0	26.0
100606	Z 33	G 1/2	3	1 x 3/8, 2 x 1/4, 1 x 1/8	Die-cast zinc	11000	38.8	67.0	33.5

Manifold - wide design

Art. No.	Type No.	Thread	Size	Outlet	Housing	Flow rate l/min	A mm	B mm	C mm
100607	T 11	G 1/4	1	4 x 1/4	Die-cast zinc	2500	47.8	52.0	26.0
100608	T 12	G 3/8	1	4 x 1/4	Die-cast zinc	2500	47.8	52.0	26.0
100609	T 33	G 1/2	3	2 x 1/4, 2 x 1/2	Die-cast zinc	11000	68.8	67.0	33.5
100610	T 34	G 3/4	3	2 x 1/4, 2 x 1/2	Die-cast zinc	11000	68.8	67.0	33.5
133131	T 44	G 3/4	4	2 x 1/4, 1 x 3/4, 1 x 1	Die-cast aluminium	18000	85.0	108.0	50.0
133132	T 45	G 1	4	2 x 1/4, 1 x 3/4, 1 x 1	Die-cast aluminium	18000	85.0	108.0	50.0

→ Flow rate l/min at P → A



KP 11

DS 9410

Accessories / spare parts for manifold G 1/4 and G 3/8 (Size 1)

Art. No.	Type No.	Description
100436	KP 11	Coupler pack for modular assembly of several devices
100437	KP 11 Z	Coupling packet for narrow manifolds
100280	DS 9410	Pressure switches - suitable for flange mounting
100281	22.DS9410.4	Moulded seal for flanged pressure switch



22.DS9410.4

Accessories / spare parts for manifold G 1/2 and G 3/4 (Size 3)

Art. No.	Type No.	Description
100442	KP 33	Coupler pack for modular assembly of several devices
100443	KP 33 Z	Coupling packet for narrow manifolds
100280	DS 9410	Pressure switches - suitable for flange mounting
100281	22.DS9410.4	Moulded seal for flanged pressure switch

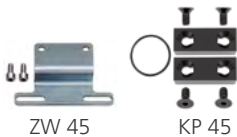

ZW 45

KP 45

Accessories / spare parts for manifold G 3/4 and G 1 (Size 4)

Art. No.	Type No.	Description
135858	ZW 45	Mounting bracket with 2 screws
135857	KP 45	Coupler pack for modular assembly of several devices

Ball valves (3/2-way)

»multifix« series

PLUS

Rotary switch can be turned 90°, lockable, with relief port including silencer.

Max. input pressure	16 bar
Max. medium temperature	60 °C
Max. ambient temperature	60 °C
Operation	Twist knob, rotatable 90°
Sealant	NBR
Flow rate measurement	At $P_1 = 6$ bar and pressure drop $\Delta p = 1$ bar

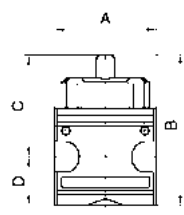
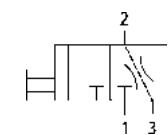

Ball valve (3/2-way)

Art. No.	Type No.	Thread	Size	Vent port	Housing	Flow rate l/min	A mm	B mm	D mm
100611	K 11	G 1/4	1	G 1/4	Die-cast zinc	2800	47.8	80.4	26.0
100612	K 12	G 3/8	1	G 1/4	Die-cast zinc	2800	47.8	80.4	26.0
100613	K 33	G 1/2	3	G 1/2	Die-cast zinc	11000	68.8	102.6	33.5
100614	K 34	G 3/4	3	G 1/2	Die-cast zinc	11000	68.8	102.6	33.5
133133	K 44	G 3/4	4	G 1/2	Die-cast aluminium	30000	85.0	140.0	50.0
133134	K 45	G 1	4	G 1/2	Die-cast aluminium	30000	85.0	140.0	50.0
100615	K 55	G 1	5	G 1/2	Aluminium	30000	82.8	133.5	50.5



K 11



K 55

Accessories for ball valve G 1/4 and G 3/8 (Size 1)

Art. No.	Type No.	Description
100436	KP 11	Coupler pack for modular assembly of several devices
100437	KP 11 Z	Coupling packet for narrow manifolds
100435	ZW 11	Mounting bracket with 2 screws
100290	567-2/M	Silencer, sintered bronze, with brass hexagon nut and thread
100273	VS 37	Padlock, band Ø 6 mm



KP 11 Z

ZW 11



567-2/M

VS 37

Accessories for ball valve G 1/2 and G 3/4 (Size 3)

Art. No.	Type No.	Description
100442	KP 33	Coupler pack for modular assembly of several devices
100443	KP 33 Z	Coupling packet for narrow manifolds
100441	ZW 33	Mounting bracket with 2 screws
100292	567-4/M	Silencer, sintered bronze, with brass hexagon nut and thread
100273	VS 37	Padlock, band Ø 6 mm

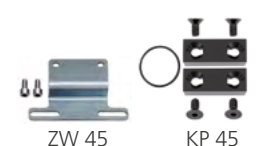

ZW 45

KP 45

Accessories for ball valve G 3/4 and G 1 (Size 4)

Art. No.	Type No.	Description
135858	ZW 45	Mounting bracket with 2 screws
135857	KP 45	Coupler pack for modular assembly of several devices

Accessories for ball valve G 1 (Size 5)

Art. No.	Type No.	Description
100446	KP 55	Coupler pack for modular assembly of several devices
100445	ZW 55	Mounting bracket with 2 screws
100616	AP 55	Connection plate
100292	567-4/M	Silencer, sintered bronze, with brass hexagon nut and thread
100273	VS 37	Padlock, band Ø 6 mm



KP 55

ZW 55



AP 55

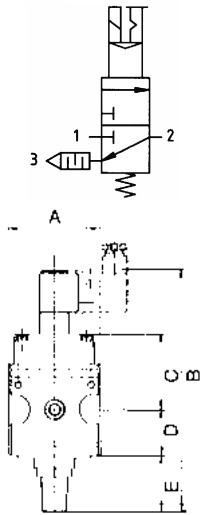

On-off valves (3/2-way valves)

»multifix« series

PLUS

Pneumatic systems or parts of systems can be switched on and off by means of an electrical signal. 3/2-way type including silencer. When they are switched off, the system is relieved at the same time.

Duty cycle	100 %
Protection IP	IP65 (P 54) acc. to DIN 40050
Electrical connection	Device plug PG 9, type B, EN 175301-803
Max. medium temperature	60 °C
Max. ambient temperature	60 °C
Sealant	NBR
Flow rate measurement	At P ₁ = 6 bar and pressure drop Δ _p = 1 bar



On-off valve (3/2-way valve)

Art. No.	Type No.	Thread	Size	Solenoid	Input pressure bar	Vent port	Flow rate l/min	A mm	B mm	C mm	D mm	E mm
100618	S 11-2	G 1/4	1	230 V AC, 50 Hz	2 - 10	G 1/4	1150	47.8	138.7	43.7	26.0	17.5
100620	S 11-4	G 1/4	1	24 V DC	2 - 10	G 1/4	1150	47.8	138.7	43.7	26.0	17.5
100622	S 33-2	G 1/2	3	230 V AC, 50 Hz	2 - 10	G 1/4	3150	68.8	185.0	56.2	33.5	44.1
100624	S 33-4	G 1/2	3	24 V DC	2 - 10	G 1/4	3150	68.8	185.0	56.2	33.5	44.1
133136	S 44-2	G 3/4	4	230 V AC, 50 Hz	2 - 16	G 1/2	12500	85.0	204.0	53.0	66.0	35.0
133138	S 44-4	G 3/4	4	24 V DC	2 - 16	G 1/2	12500	85.0	204.0	53.0	66.0	35.0
133140	S 45-2	G 1	4	230 V AC, 50 Hz	2 - 16	G 1/2	12500	85.0	204.0	53.0	66.0	35.0
133142	S 45-4	G 1	4	24 V DC	2 - 16	G 1/2	12500	85.0	204.0	53.0	66.0	35.0

➔ On-off valves are also available in a pneumatically operated version. Please ask for more information.



Accessories / spare parts for on-off valve G 1/4

Art. No.	Type No.	Description
100436	KP 11	Coupler pack for modular assembly of several devices
100437	KP 11 Z	Coupling packet for narrow manifolds
100435	ZW 11	Mounting bracket with 2 screws
100290	567-2/M	Silencer, sintered bronze, with brass hexagon nut and thread
100409	1920.9B	Coupling socket form B, EN 175301-803
100410	S 11-19N	Replacement solenoid 230 V AC, 50 Hz
100412	S 11-18N	Replacement solenoid 24 V DC
100625	S 11-38N	3/2-way valve for pilot control with manual operation

Accessories / spare parts for on-off valve G 1/2

Art. No.	Type No.	Description
100442	KP 33	Coupler pack for modular assembly of several devices
100443	KP 33 Z	Coupling packet for narrow manifolds
100441	ZW 33	Mounting bracket with 2 screws
100292	567-4/M	Silencer, sintered bronze, with brass hexagon nut and thread
100409	1920.9B	Coupling socket form B, EN 175301-803
100410	S 11-19N	Replacement solenoid 230 V AC, 50 Hz
100412	S 11-18N	Replacement solenoid 24 V DC
100625	S 11-38N	3/2-way valve for pilot control with manual operation

Accessories / spare parts for on-off valve G 3/4 and G 1

Art. No.	Type No.	Description
135858	ZW 45	Mounting bracket with 2 screws
135857	KP 45	Coupler pack for modular assembly of several devices
100308	400-900-17	Pilot valve 230 V AC
100306	400-900-42	Pilot valve 24 V DC
100310	1920.FU	Connector type C



Start-up valves

»multifix« series

PLUS

Seat valves operated by secondary pressure for controlled pressurisation of pneumatic systems. The full cross-section of the regulator is opened at 50% of the input pressure. The filling time can be altered by turning the adjusting screw.

Input pressure	2 - 16 bar
Max. medium temperature	60 °C
Max. ambient temperature	60 °C
Sealant	NBR
Flow rate measurement	At P ₁ = 6 bar and pressure drop Δp = 1 bar

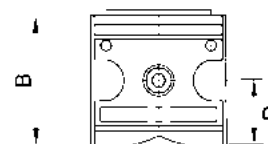
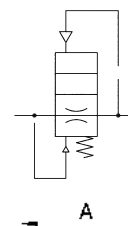

Start-up valve

Art. No.	Type No.	Thread	Size	Housing	Flow rate l/min	A mm	B mm	D mm
100626	A 11 F	G 1/4	1	Die-cast zinc	1100	47.8	54.2	26.8
100627	A 33 F	G 1/2	3	Die-cast zinc	3500	68.8	71.6	35.1
133143	A 44 F	G 3/4	4	Die-cast aluminium	10000	85.0	119.0	53.0
133144	A 45 F	G 1	4	Die-cast aluminium	10000	85.0	119.0	53.0
100628	A 54 F	G 3/4	5	Aluminium	16000	99.7	104.0	52.0
100629	A 55 F	G 1	5	Aluminium	16000	99.7	104.0	52.0



A 11 F



A 55 F

Accessories for start-up valve G 1/4 (Size 1)

Art. No.	Type No.	Description
100436	KP 11	Coupler pack for modular assembly of several devices
100437	KP 11 Z	Coupling packet for narrow manifolds



KP 11

Accessories for start-up valve G 1/2 (Size 3)

Art. No.	Type No.	Description
100442	KP 33	Coupler pack for modular assembly of several devices
100443	KP 33 Z	Coupling packet for narrow manifolds



KP 33

Accessories for start-up valve G 3/4 and G 1 (Size 4)

Art. No.	Type No.	Description
135857	KP 45	Coupler pack for modular assembly of several devices

Accessories for start-up valve G 3/4 and G 1 (Size 5)

Art. No.	Type No.	Description
100446	KP 55	Coupler pack for modular assembly of several devices



KP 55

1

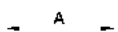
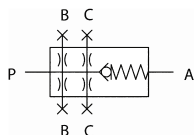

Non-return valves

»multifix« series

PLUS

Spring-loaded seat valves.

Min. opening pressure	0.1 bar
Max. input pressure	16 bar
Max. medium temperature	50 °C
Max. ambient temperature	50 °C
Housing	Die-cast zinc
Sealant	NBR
Flow rate measurement	At $P_1 = 6$ bar and pressure drop $\Delta p = 1$ bar



V 11

Non-return valve

Art. No.	Type No.	Thread	Size	Flow rate l/min	A mm	B mm	C mm	D mm
100630	V 11	G 1/4	1	700	47.8	52.0	26.0	26.0
100631	V 12	G 3/8	1	700	47.8	52.0	26.0	26.0
100632	V 33/1	G 1/2	3	6000	68.8	67.0	33.5	33.5
100633	V 34/1	G 3/4	3	6000	68.8	67.0	33.5	33.5



KP 11

Accessories for non-return valve G 1/4 and G 3/8

Art. No.	Type No.	Description
100436	KP 11	Coupler pack for modular assembly of several devices
100437	KP 11 Z	Coupling packet for narrow manifolds



KP 33

Accessories for non-return valve G 1/2 and G 3/4

Art. No.	Type No.	Description
100442	KP 33	Coupler pack for modular assembly of several devices
100443	KP 33 Z	Coupling packet for narrow manifolds

Pressure regulators

»variobloc« series

PLUS

Reversible diaphragm pressure regulators, independent of inlet pressure, with self-relieving design.

The pressure setting can be locked by pushing the knob down.

Approved series in modern industrial design, with the following key benefits:

- Simple handling
- Convenient modular assembly thanks to innovative fasteners
- Excellent flow values

Max. input pressure	25 bar
Max. medium temperature	80 °C
Max. ambient temperature	80 °C
Housing	Die-cast zinc
Spring bonnet	POM
Sealant	NBR
Diaphragms	NBR
Flow rate measurement	At $P_1 = 10$ bar, $P_2 = 6$ bar and pressure drop $\Delta p = 1$ bar

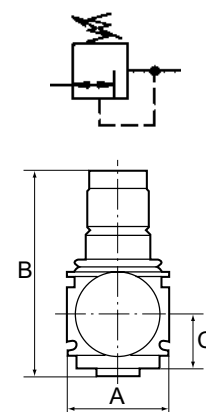

Pressure regulator, incl. pressure gauge

Art. No.	Type No.	Thread	Size	Control range bar	Pressure gauge display bar	Flow rate l/min	A mm	B mm	C mm
100634	VR 22	G 1/4	1	0,5 - 6	0 - 6	2000	48.0	98.0	26.0
100635	VR 23	G 1/4	1	0,5 - 10	0 - 10	2000	48.0	98.0	26.0
100636	VR 24	G 1/4	1	0,5 - 16	0 - 16	2000	48.0	98.0	26.0
100637	VR 32	G 3/8	1	0,5 - 6	0 - 6	3200	48.0	98.0	26.0
100638	VR 33	G 3/8	1	0,5 - 10	0 - 10	3200	48.0	98.0	26.0
100639	VR 34	G 3/8	1	0,5 - 16	0 - 16	3200	48.0	98.0	26.0
100640	VR 42	G 1/2	2	0,5 - 6	0 - 6	7000	70.0	134.0	33.0
100641	VR 43	G 1/2	2	0,5 - 10	0 - 10	7000	70.0	134.0	33.0
100642	VR 44	G 1/2	2	0,5 - 16	0 - 16	7000	70.0	134.0	33.0
100643	VR 52	G 3/4	2	0,5 - 6	0 - 6	8000	70.0	134.0	33.0
100644	VR 53	G 3/4	2	0,5 - 10	0 - 10	8000	70.0	134.0	33.0
100645	VR 54	G 3/4	2	0,5 - 16	0 - 16	8000	70.0	134.0	33.0
100646	VR 62	G 1	2	0,5 - 6	0 - 6	8000	125.0	134.0	33.0
100647	VR 63	G 1	2	0,5 - 10	0 - 10	8000	125.0	134.0	33.0
100648	VR 64	G 1	2	0,5 - 16	0 - 16	8000	125.0	134.0	33.0



VR 34

- You can find connection elements at page 91
- Lockable pressure regulators available on request

Spare parts

Art. No.	Type No.	Description
100649	VZ 781	Set of wearing parts, compatible with G 1/4 - G 3/8
100650	VZ 782	Set of wearing parts, compatible with G 1/2 - G 1



VZ 781

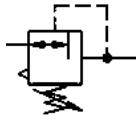

Pressure regulators with continuous pressure supply

»variobloc« series

PLUS

Diaphragm pressure regulators with self-relieving design for mounting side by side. The pressure setting can be locked by pushing the knob down. By assembling two or more controllers together, it is possible to supply several working air circuits with different output pressures via a single supply line.

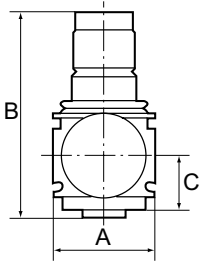

Max. input pressure	25 bar
Max. medium temperature	80 °C
Max. ambient temperature	80 °C
Housing	Die-cast zinc
Spring bonnet	POM-brass
Sealant	NBR
Flow rate measurement	At $P_1 = 10$ bar, $P_2 = 6$ bar and pressure drop $\Delta p = 1$ bar



VRB 22

Pressure regulator with pressure supply at both ends, incl. pressure gauge

Art. No.	Type No.	Thread	Size	Connection rear	Control range bar	Pressure gauge display bar	Flow rate l/min	A mm	B mm	C mm
100651	VRB 22	G 1/4	1	G 1/4	0,5 - 6	0 - 6	1800	48.0	98.0	26.0
100652	VRB 23	G 1/4	1	G 1/4	0,5 - 10	0 - 10	1800	48.0	98.0	26.0
100653	VRB 24	G 1/4	1	G 1/4	0,5 - 16	0 - 16	1800	48.0	98.0	26.0
100654	VRB 32	G 3/8	1	G 1/4	0,5 - 6	0 - 6	1800	48.0	98.0	26.0
100655	VRB 33	G 3/8	1	G 1/4	0,5 - 10	0 - 10	1800	48.0	98.0	26.0
100656	VRB 34	G 3/8	1	G 1/4	0,5 - 16	0 - 16	1800	48.0	98.0	26.0
149188	VRB 42	G 1/2	2	G 1/2	0,5 - 6	0 - 6	5800	70.0	134.0	33.0
149189	VRB 43	G 1/2	2	G 1/2	0,5 - 10	0 - 10	5800	70.0	134.0	33.0
149190	VRB 44	G 1/2	2	G 1/2	0,5 - 16	0 - 16	5800	70.0	134.0	33.0
149191	VRB 52	G 3/4	2	G 1/2	0,5 - 6	0 - 6	6800	70.0	134.0	33.0
149192	VRB 53	G 3/4	2	G 1/2	0,5 - 10	0 - 10	6800	70.0	134.0	33.0
149193	VRB 54	G 3/4	2	G 1/2	0,5 - 16	0 - 16	6800	70.0	134.0	33.0
149194	VRB 62	G 1	2	G 1/2	0,5 - 6	0 - 6	6800	125.0	134.0	33.0
149195	VRB 63	G 1	2	G 1/2	0,5 - 10	0 - 10	6800	125.0	134.0	33.0
149196	VRB 64	G 1	2	G 1/2	0,5 - 16	0 - 16	6800	125.0	134.0	33.0

- You can find connection elements at page 91
- Lockable pressure regulators available on request
- The port for the output pressure (P2) is on the rear!



VZ 781

Spare parts

Art. No.	Type No.	Description
100649	VZ 781	Set of wearing parts, compatible with G 1/4 - G 3/8
100650	VZ 782	Set of wearing parts, compatible with G 1/2 - G 1

Precision pressure regulators

»variobloc« series

PLUS

Pre-pressure independent, reversible diaphragm pressure regulator with secondary venting for applications that require a precise pressure regulation. The line pressure is regulated by the pressure regulator to the set working pressure/secondary pressure and maintains this constantly regardless of pressure fluctuations and air consumption. The precision pressure regulator is characterised by a very low internal air consumption (< 1.5 l/min).

Max. input pressure	25 bar
Max. medium temperature	80 °C
Max. ambient temperature	80 °C
Housing	Die-cast zinc
Spring bonnet	POM-brass
Sealant	NBR
Max. internal air consumption	1.5 l/min (depending on secondary pressure)
Flow rate measurement	At $P_1 = 10$ bar, $P_2 = 6$ bar and pressure drop $\Delta_p = 1$ bar

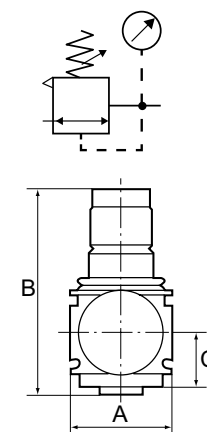

Precision pressure regulator, incl. pressure gauge

Art. No.	Type No.	Thread	Size	Control range bar	Pressure gauge display bar	Flow rate l/min	A mm	B mm	C mm
149212	VRP 22	G 1/4	1	0,1 - 3	0 - 3	2000	48.0	98.0	26.0
149214	VRP 23	G 1/4	1	0,2 - 6	0 - 6	2000	48.0	98.0	26.0
149215	VRP 24	G 1/4	1	0,5 - 10	0 - 10	2000	48.0	98.0	26.0
149216	VRP 32	G 3/8	1	0,1 - 3	0 - 3	3200	48.0	98.0	26.0
149217	VRP 33	G 3/8	1	0,2 - 6	0 - 6	3200	48.0	98.0	26.0
149218	VRP 34	G 3/8	1	0,5 - 10	0 - 10	3200	48.0	98.0	26.0
149219	VRP 42	G 1/2	2	0,1 - 3	0 - 3	7000	70.0	134.0	33.0
149220	VRP 43	G 1/2	2	0,2 - 6	0 - 6	7000	70.0	134.0	33.0
149221	VRP 44	G 1/2	2	0,5 - 10	0 - 10	7000	70.0	134.0	33.0
149222	VRP 52	G 3/4	2	0,1 - 3	0 - 3	8000	70.0	134.0	33.0
149223	VRP 53	G 3/4	2	0,2 - 6	0 - 6	8000	70.0	134.0	33.0
149224	VRP 54	G 3/4	2	0,5 - 10	0 - 10	8000	70.0	134.0	33.0
149225	VRP 62	G 1	2	0,1 - 3	0 - 3	8000	125.0	134.0	33.0
149226	VRP 63	G 1	2	0,2 - 6	0 - 6	8000	125.0	134.0	33.0
149227	VRP 64	G 1	2	0,5 - 10	0 - 10	8000	125.0	134.0	33.0

- You can find connection elements at page 91
- Lockable pressure regulators available on request



VRP 34

Spare parts

Art. No.	Type No.	Description
149570	VZ 783	Set of wearing parts, compatible with G 1/4 - G 3/8
149571	VZ 784	Set of wearing parts, compatible with G 1/2 - G 1



VZ 783

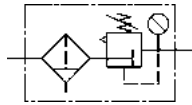

Filter regulators

»variobloc« series

PLUS

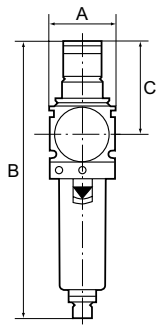

Reversible diaphragm pressure regulators, independent of inlet pressure, with self-relieving design, combined with a centrifugal separator. The pressure setting can be locked by pushing the knob down. Approved series in modern industrial design, with the following key benefits:

- Simple handling
- Convenient modular assembly thanks to innovative fasteners
- Excellent flow values

Max. medium temperature	50 °C
Max. ambient temperature	50 °C
Control range	0,5 - 10 bar
Pressure gauge display	0 - 10 bar
Condensate drain	Manual
Housing	Die-cast zinc
Spring bonnet	POM
Sealant	NBR
Diaphragms	NBR
Filter rating	40 µm
Flow rate measurement	At $P_1 = 10$ bar, $P_2 = 6$ bar and pressure drop $\Delta p = 1$ bar



VFR 53

Filter regulator with polycarbonate bowl and pressure gauge

Art. No.	Type No.	Thread	Size	Max. input pressure bar	Flow rate l/min	A mm	B mm	C mm
100657	VFR 23	G 1/4	1	16	2000	48.0	203.0	68.0
100658	VFR 33	G 3/8	1	16	3000	48.0	203.0	68.0
100659	VFR 43	G 1/2	2	16	5500	70.0	273.0	98.0
100660	VFR 53	G 3/4	2	16	6500	70.0	273.0	98.0
100661	VFR 63	G 1	2	16	6500	124.0	273.0	98.0

- You can find connection elements at page 91
- Lockable filter regulators available on request
- With metal bowl the maximum inlet pressure increases to 20 bar

Accessories / spare parts for filter regulator G 1/4 and G 3/8 (Size 1)

Art. No.	Type No.	Description
100662	VZ 501	Plastic bowl with manual drain valve for G 1/4 - G 3/8
100664	VZ 511	Plastic bowl with automatic drain valve for G 1/4 - G 3/8
100666	VZ 531	Bowl guard for G 1/4 - G 3/8
100677	65/0-N	Fully-automatic drain valve
100649	VZ 781	Set of wearing parts, compatible with G 1/4 - G 3/8
100672	VZ 741	Filter element 40 µm for G 1/4, G 3/8
100674	VZ 741/5	Filter element 5 µm for G 1/4, G 3/8
100676	VZ 751	Semi-automatic drain valve for plastic- and metal bowl

Accessories / spare parts for filter regulator G 1/2, G 3/4 and G 1 (Size 2)

Art. No.	Type No.	Description
100663	VZ 502	Plastic bowl with manual drain valve for G 1/2 - G 1
100665	VZ 512	Plastic bowl with automatic drain valve for G 1/2 - G 1
100667	VZ 532	Bowl guard for G 1/2 - G 1
100677	65/0-N	Fully-automatic drain valve
100650	VZ 782	Set of wearing parts, compatible with G 1/2 - G 1
100673	VZ 742	Filter element 40 µm for G 1/2, G 3/4, G 1
100675	VZ 742/5	Filter element 5 µm for G 1/2, G 3/4, G 1
100676	VZ 751	Semi-automatic drain valve for plastic- and metal bowl



VZ 501 VZ 511



VZ 531 65/0-N



VZ 741/5 VZ 751

Filters

»variobloc« series

PLUS

Centrifugal separators with a sintered filter element. Filtration takes place in a 2-stage process comprising cyclone separation (condensate) and a PE filter element (particles).

Approved series in modern industrial design, with the following key benefits:

- Simple handling
- Convenient modular assembly thanks to innovative fasteners
- Excellent flow values

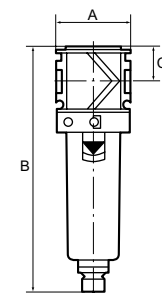
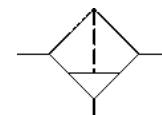

Max. medium temperature	50 °C
Max. ambient temperature	50 °C
Condensate drain	Manual
Housing	Die-cast zinc
Sealant	NBR
Filter rating	40 µm
Flow rate measurement	At P ₁ = 6 bar and pressure drop Δ _p = 1 bar

Filter with polycarbonate bowl

Art. No.	Type No.	Thread	Size	Max. input pressure bar	Flow rate l/min	A mm	B mm	C mm
100678	VF 22	G 1/4	1	16	1800	48.0	155.0	22.0
100679	VF 23	G 3/8	1	16	2000	48.0	155.0	22.0
100680	VF 24	G 1/2	2	16	3200	70.0	202.0	26.0
100681	VF 25	G 3/4	2	16	3500	70.0	202.0	26.0
100682	VF 26	G 1	2	16	3500	124.0	202.0	26.0



VF 25

- ➔ You can find connection elements at page 91
- ➔ With metal bowl the maximum inlet pressure increases to 20 bar

Accessories / spare parts for filter G 1/4 and G 3/8 (Size 1)

Art. No.	Type No.	Description
100662	VZ 501	Plastic bowl with manual drain valve for G 1/4 - G 3/8
100664	VZ 511	Plastic bowl with automatic drain valve for G 1/4 - G 3/8
100666	VZ 531	Bowl guard for G 1/4 - G 3/8
100677	65/0-N	Fully-automatic drain valve
100672	VZ 741	Filter element 40 µm for G 1/4, G 3/8
100674	VZ 741/5	Filter element 5 µm for G 1/4, G 3/8
100676	VZ 751	Semi-automatic drain valve for plastic- and metal bowl



VZ 501

VZ 511

Accessories / spare parts for filter G 1/2, G 3/4 and G 1 (Size 2)

Art. No.	Type No.	Description
100663	VZ 502	Plastic bowl with manual drain valve for G 1/2 - G 1
100665	VZ 512	Plastic bowl with automatic drain valve for G 1/2 - G 1
100667	VZ 532	Bowl guard for G 1/2 - G 1
100677	65/0-N	Fully-automatic drain valve
100673	VZ 742	Filter element 40 µm for G 1/2, G 3/4, G 1
100675	VZ 742/5	Filter element 5 µm for G 1/2, G 3/4, G 1
100676	VZ 751	Semi-automatic drain valve for plastic- and metal bowl



VZ 531

65/0-N



VZ 742

VZ 741/5



VZ 751

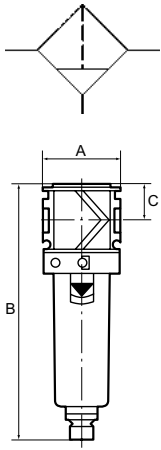

Micro-filters (fine-filters)

»variobloc« series

PLUS

Borosilicate filter for all applications where compliance with strict compressed air purity requirements is vital. As the second stage downstream of the standard filter, the micro-filter removes 99.999 % of even the finest remaining particles from water, oil and dirt with practically zero residues (filter rating: 0.01 µm).

Max. medium temperature	50 °C
Max. ambient temperature	50 °C
Filter rating	0.01 µm
Efficiency	99.999 %
Air quality acc. to ISO 8573.1	Class 1 dirt, class 1 oil
Flow rate measurement	At P ₁ = 7 bar and pressure drop Δp = 0,1 bar



VM 22

Micro-filter with polycarbonate bowl

Art. No.	Type No.	Thread	Size	Max. input pressure bar	Flow rate l/min	A mm	B mm	C mm
100683	VM 22	G 1/4	1	16	370	48.0	155.0	22.0
100684	VM 23	G 3/8	1	16	420	48.0	155.0	22.0
100685	VM 24	G 1/2	2	16	1000	70.0	202.0	26.0
100686	VM 25	G 3/4	2	16	1100	70.0	202.0	26.0
100687	VM 26	G 1	2	16	1100	124.0	202.0	26.0

- ➔ You can find connection elements at page 91
- ➔ With metal bowl the maximum inlet pressure increases to 20 bar



VZ 521



VZ 531



65/0-N



VZ 751



VZ 761

Accessories / spare parts for micro-filter G 1/4 and G 3/8 (Size 1)

Art. No.	Type No.	Description
100688	VZ 521	Plastic bowl with manual drain valve for G 1/4 - G 3/8
100666	VZ 531	Bowl guard for G 1/4 - G 3/8
100677	65/0-N	Fully-automatic drain valve
100676	VZ 751	Semi-automatic drain valve for plastic- and metal bowl
100690	VZ 761	Filter element 0.01 µm, for G 1/4, G 3/8

Accessories / spare parts for micro-filter G 1/2, G 3/4 and G 1 (Size 2)

Art. No.	Type No.	Description
100689	VZ 522	Plastic bowl with manual drain valve for G 1/2 - G 1
100667	VZ 532	Bowl guard for G 1/2 - G 1
100677	65/0-N	Fully-automatic drain valve
100676	VZ 751	Semi-automatic drain valve for plastic- and metal bowl
100691	VZ 762	Filter element 0.01 µm, for G 1/2, G 3/4, G 1

Activated carbon filters

»variobloc« series

PLUS

Activated carbon filters are used to absorb oil vapour from the compressed air. The incoming compressed air should be dry and free of impurities (upstream connection of a micro-filter is recommended).

Max. medium temperature	50 °C
Max. ambient temperature	50 °C
Residual oil content	0.003 mg/m ³
Air quality acc. to ISO 8573.1	Class 1 dirt, class 1 oil
Flow rate measurement	At P ₁ = 7 bar and pressure drop Δp = 0,2 bar

Activated carbon filter with polycarbonate bowl

Art. No.	Type No.	Thread	Size	Max. input pressure bar	Flow rate l/min	A mm	B mm	C mm
100692	VAK 22	G 1/4	1	16	800	48.0	142.0	22.0
100693	VAK 23	G 3/8	1	16	1000	48.0	142.0	22.0
100694	VAK 24	G 1/2	2	16	1200	70.0	193.0	26.0
100695	VAK 25	G 3/4	2	16	1300	70.0	193.0	26.0
100696	VAK 26	G 1	2	16	1300	124.0	193.0	26.0

→ With metal bowl the maximum inlet pressure increases to 20 bar

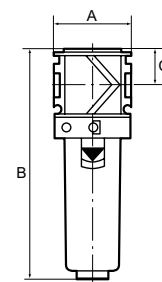
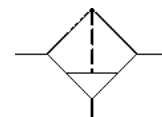

VAK 24

Accessories / spare parts for activated carbon filter G 1/4 and G 3/8 (Size 1)

Art. No.	Type No.	Description
100666	VZ 531	Bowl guard for G 1/4 - G 3/8
100697	VZ 601	Plastic bowl for G 1/4 - G 3/8
100701	VZ 771	Activated carbon filter element for G 1/4, G 3/8



VZ 531



VZ 601

Accessories / spare parts for activated carbon filter G 1/2, G 3/4 and G 1 (Size 2)

Art. No.	Type No.	Description
100667	VZ 532	Bowl guard for G 1/2 - G 1
100698	VZ 602	Plastic bowl for G 1/2 - G 1
100702	VZ 772	Activated carbon filter element for G 1/2, G 3/4, G 1



VZ 771

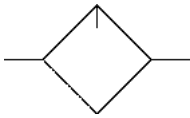

Oil-mist lubricators

»variobloc« series

PLUS

Proportional lubricators, oil can be filled under pressure.
 Approved series in modern industrial design, with the following key benefits:

- Simple handling
- Convenient modular assembly thanks to innovative fasteners
- Excellent flow values

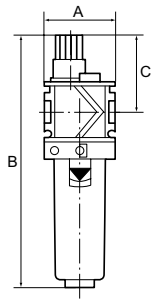

Max. medium temperature	50 °C
Max. ambient temperature	50 °C
Housing	Die-cast zinc
Sealant	NBR
Sight dome	PA
Oil grade	CL 32 acc. to DIN 51517-ISO VG 32
Flow rate measurement	At $P_1 = 6$ bar and pressure drop $\Delta p = 1$ bar



VN 24

Oil-mist lubricator with polycarbonate bowl

Art. No.	Type No.	Thread	Size	Max. input pressure bar	Flow rate l/min	A mm	B mm	C mm
100703	VN 22	G 1/4	1	16	3400	48.0	171.0	52.0
100704	VN 23	G 3/8	1	16	4400	48.0	171.0	52.0
100705	VN 24	G 1/2	2	16	4600	70.0	224.0	57.0
100706	VN 25	G 3/4	2	16	7500	70.0	224.0	57.0
100707	VN 26	G 1	2	16	7500	124.0	224.0	57.0

- We recommend our special pneumatic oil on page 145
- With metal bowl the maximum inlet pressure increases to 20 bar

Accessories / spare parts for oil-mist lubricator G 1/4 and G 3/8 (Size 1)

Art. No.	Type No.	Description
100697	VZ 601	Plastic bowl for G 1/4 - G 3/8
100708	VZ 721	Sight dome, plastic for G 1/4, G 3/8
100710	VZ 731	Sight dome, metal for G 1/4, G 3/8



VZ 601

VZ 721

Accessories / spare parts for oil-mist lubricator G 1/2, G 3/4 and G 1 (Size 2)

Art. No.	Type No.	Description
100698	VZ 602	Plastic bowl for G 1/2 - G 1
100709	VZ 722	Sight dome, plastic for G 1/2, G 3/4, G 1
100711	1412.7.909	Sight dome, metal for G 1/2, G 3/4



VZ 731

VZ 722



1412.7.909

Service units

two-pieces, »variobloc« series

PLUS

Two-piece service units consisting of a reversible diaphragm pressure regulator, independent of inlet pressure, with self-relieving design, combined with a centrifugal separator and a proportional lubricator.

Approved series in modern industrial design, with the following key benefits:

- Simple handling
- Convenient modular assembly thanks to innovative fasteners
- Excellent flow values

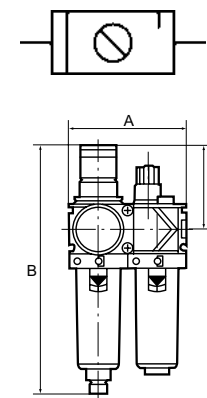

Max. medium temperature	50 °C
Max. ambient temperature	50 °C
Control range	0,5 - 10 bar
Pressure gauge display	0 - 10 bar
Housing	Die-cast zinc
Spring bonnet	POM
Sealant	NBR
Diaphragms	NBR
Filter rating	40 µm
Condensate drain	Manual
Sight dome	PA
Flow rate measurement	At $P_1 = 10$ bar, $P_2 = 6$ bar and pressure drop $\Delta p = 1$ bar

Service unit, 2-piece with polycarbonate bowl

Art. No.	Type No.	Thread	Size	Max. input pressure bar	Flow rate l/min	A mm	B mm	C mm
100717	VW 22	G 1/4	1	16	1500	96.0	203.0	68.0
100718	VW 23	G 3/8	1	16	1800	96.0	203.0	68.0
100719	VW 24	G 1/2	2	16	3400	140.0	273.0	98.0
100720	VW 25	G 3/4	2	16	5000	140.0	273.0	98.0
100721	VW 26	G 1	2	16	5000	194.0	273.0	98.0



VW 22

- Service units are also available in other control ranges (0.5 - 6 bar and 0.5 - 16 bar) and in lockable version. Please ask for more information.
- You can find connection elements at page 91
- We recommend our special pneumatic oil on page 145
- With metal bowl the maximum inlet pressure increases to 20 bar

Accessories / spare parts for service unit G 1/4 and G 3/8 (Size 1)

Art. No.	Type No.	Description
100662	VZ 501	Plastic bowl with manual drain valve for G 1/4 - G 3/8
100664	VZ 511	Plastic bowl with automatic drain valve for G 1/4 - G 3/8
100666	VZ 531	Bowl guard for G 1/4 - G 3/8
100697	VZ 601	Plastic bowl for G 1/4 - G 3/8
100677	65/0-N	Fully-automatic drain valve
100649	VZ 781	Set of wearing parts, compatible with G 1/4 - G 3/8
100672	VZ 741	Filter element 40 µm for G 1/4, G 3/8
100708	VZ 721	Sight dome, plastic for G 1/4, G 3/8
100710	VZ 731	Sight dome, metal for G 1/4, G 3/8
100676	VZ 751	Semi-automatic drain valve for plastic- and metal bowl



VZ 501



VZ 511



VZ 531



VZ 601



65/0-N



VZ 742



VZ 721



1412.7.909

Accessories / spare parts for service unit G 1/2, G 3/4 and G 1 (Size 2)

Art. No.	Type No.	Description
100663	VZ 502	Plastic bowl with manual drain valve for G 1/2 - G 1
100665	VZ 512	Plastic bowl with automatic drain valve for G 1/2 - G 1
100667	VZ 532	Bowl guard for G 1/2 - G 1
100698	VZ 602	Plastic bowl for G 1/2 - G 1
100677	65/0-N	Fully-automatic drain valve
100650	VZ 782	Set of wearing parts, compatible with G 1/2 - G 1
100673	VZ 742	Filter element 40 µm for G 1/2, G 3/4, G 1
100709	VZ 722	Sight dome, plastic for G 1/2, G 3/4, G 1
100676	VZ 751	Semi-automatic drain valve for plastic- and metal bowl
100711	1412.7.909	Sight dome, metal for G 1/2, G 3/4

1

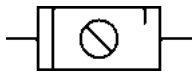

Service units

three-pieces, »variobloc« series

PLUS

Three-piece service units consisting of a reversible diaphragm pressure regulator, independent of inlet pressure, with self-relieving design, combined with a centrifugal separator and a proportional lubricator.

Approved series in modern industrial design, with the following key benefits:

- Simple handling
- Convenient modular assembly thanks to innovative fasteners
- Excellent flow values

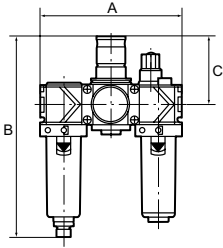

VW 14

Max. medium temperature	50 °C
Max. ambient temperature	50 °C
Control range	0,5 - 10 bar
Pressure gauge display	0 - 10 bar
Housing	Die-cast zinc
Spring bonnet	POM
Sealant	NBR
Diaphragms	NBR
Filter rating	40 µm
Condensate drain	Manual
Sight dome	PA
Flow rate measurement	At $P_1 = 10$ bar, $P_2 = 6$ bar and pressure drop $\Delta_p = 1$ bar

Service unit, 3-piece with polycarbonate bowl

Art. No.	Type No.	Thread	Size	Max. input pressure bar	Flow rate l/min	A mm	B mm	C mm
100712	VW 12	G 1/4	1	16	1500	144.0	201.0	68.0
100713	VW 13	G 3/8	1	16	1800	144.0	201.0	68.0
100714	VW 14	G 1/2	2	16	3400	210.0	274.0	98.0
100715	VW 15	G 3/4	2	16	5000	210.0	274.0	98.0
100716	VW 16	G 1	2	16	5000	264.0	274.0	98.0

- ➔ Service units are also available in other control ranges (0.5 - 6 bar and 0.5 - 16 bar) and in lockable version. Please ask for more information.
- ➔ You can find connection elements at page 91
- ➔ We recommend our special pneumatic oil on page 145
- ➔ With metal bowl the maximum inlet pressure increases to 20 bar



65/0-N

VZ 781



VZ 742

VZ 721



VZ 731

VZ 751

VZ 722

1412.7.909

Accessories / spare parts for service unit G 1/4 and G 3/8 (Size 1)

Art. No.	Type No.	Description
100662	VZ 501	Plastic bowl with manual drain valve for G 1/4 - G 3/8
100664	VZ 511	Plastic bowl with automatic drain valve for G 1/4 - G 3/8
100666	VZ 531	Bowl guard for G 1/4 - G 3/8
100697	VZ 601	Plastic bowl for G 1/4 - G 3/8
100677	65/0-N	Fully-automatic drain valve
100649	VZ 781	Set of wearing parts, compatible with G 1/4 - G 3/8
100672	VZ 741	Filter element 40 µm for G 1/4, G 3/8
100708	VZ 721	Sight dome, plastic for G 1/4, G 3/8
100710	VZ 731	Sight dome, metal for G 1/4, G 3/8
100676	VZ 751	Semi-automatic drain valve for plastic- and metal bowl

Accessories / spare parts for service unit G 1/2, G 3/4 and G 1 (Size 2)

Art. No.	Type No.	Description
100663	VZ 502	Plastic bowl with manual drain valve for G 1/2 - G 1
100665	VZ 512	Plastic bowl with automatic drain valve for G 1/2 - G 1
100667	VZ 532	Bowl guard for G 1/2 - G 1
100698	VZ 602	Plastic bowl for G 1/2 - G 1
100677	65/0-N	Fully-automatic drain valve
100650	VZ 782	Set of wearing parts, compatible with G 1/2 - G 1
100673	VZ 742	Filter element 40 µm for G 1/2, G 3/4, G 1
100709	VZ 722	Sight dome, plastic for G 1/2, G 3/4, G 1
100676	VZ 751	Semi-automatic drain valve for plastic- and metal bowl
100711	1412.7.909	Sight dome, metal for G 1/2, G 3/4

Manifolds

»variobloc« series

PLUS

For removing un lubricated air when the manifold is flanged on upstream of the oil-mist lubricator. An integrated non-return valve prevents oil inflow from the oil-mist lubricator or the line.

No. of outlets	4 (all sealed on delivery)
Flow rate measurement	At $P_1 = 6$ bar and pressure drop $\Delta p = 1$ bar

Manifold									
Art. No.	Type No.	Thread	Size	Outlet top / bottom	Outlet front / back	Flow rate l/min	A mm	B mm	
100722	VV 22	G 1/4	1	G 3/8	G 1/4	900	48.0	44.0	
100723	VV 23	G 3/8	1	G 3/8	G 1/4	900	48.0	44.0	
100724	VV 24	G 1/2	2	G 3/8 / G 1/2	G 1/4	4000	70.0	56.0	
100725	VV 25	G 3/4	2	G 3/8 / G 1/2	G 1/4	5000	70.0	56.0	
100726	VV 26	G 1	2	G 3/8 / G 1/2	G 1/4	5000	124.0	56.0	

→ You can find connection elements at page 91

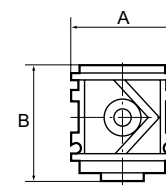
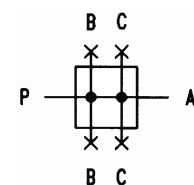

VV 23

Ball valves (3/2-way)

»variobloc« series

PLUS

Used as the main shut-off element, especially for flanging onto the start of a variobloc service unit. With pressure relief and silencer. Can be locked with a standard padlock.

Max. operating pressure	25 bar
Max. ambient temperature	80 °C
Flow rate measurement	At $P_1 = 6$ bar and pressure drop $\Delta p = 1$ bar

Ball valve (3/2-way)							
Art. No.	Type No.	Thread	Size	Flow rate l/min	A mm	B mm	
100727	VK 22	G 1/4	1	4300	48.0	80.0	
100728	VK 23	G 3/8	1	4400	48.0	80.0	
100729	VK 24	G 1/2	2	9000	70.0	92.0	
100730	VK 25	G 3/4	2	11000	70.0	92.0	
100731	VK 26	G 1	2	11000	125.0	92.0	

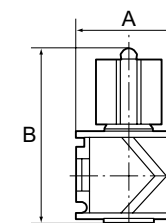
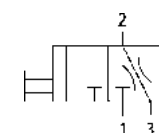

VK 23

Accessories		
Art. No.	Type No.	Description
100273	VS 37	Padlock, band Ø 6 mm



VS 37

1

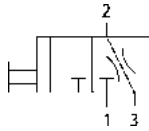

Ball valves (3/2-way) with pneumatic drive

»variobloc« series

PLUS

Used as the main shut-off element, especially for flanging onto the start of a variobloc service unit. The variant with pneumatic drive (size 2) allows the use even in poorly accessible areas as a remote control. With pressure relief and silencer.

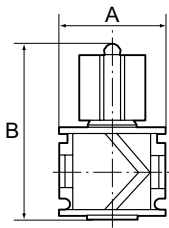

Max. operating pressure	25 bar
Pilot pressure	5.6 - 7.4 bar
Max. ambient temperature	80 °C
Flow rate measurement	At $P_1 = 6$ bar and pressure drop $\Delta p = 1$ bar



VK 24-P

Ball valve (3/2-way) with pneumatic drive

Art. No.	Type No.	Thread	Size	Flow rate l/min	A mm	B mm
158058	VK 24-P	G 1/2	2	9000	70.0	120.0
158059	VK 25-P	G 3/4	2	11000	70.0	120.0
158060	VK 26-P	G 1	2	11000	125.0	120.0

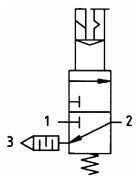

On-off valves (3/2-way valves)

»variobloc« series

PLUS

For pressurising and relieving pneumatic systems. 3/2-way type including silencer. Ideal as the main "on" valve for service units. The pressure in the line is exhausted when the valve is switched off.

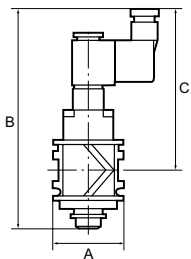

Working pressure	3 - 10 bar
Protection IP	IP65 acc. to DIN 40050
Operating voltage	24 V DC
Electrical connection	Device plug PG 9, type B, EN 175301-803
Flow rate measurement	At $P_1 = 6$ bar and pressure drop $\Delta p = 1$ bar



VS 22

On-off valve (3/2-way valve)

Art. No.	Type No.	Thread	Size	Flow rate l/min	A mm	B mm	C mm
100732	VS 22	G 1/4	1	2200	48.0	147.0	108.0
100733	VS 23	G 3/8	1	2600	48.0	147.0	108.0
100734	VS 24	G 1/2	2	3300	70.0	157.0	113.0
100735	VS 25	G 3/4	2	3800	70.0	157.0	113.0
100736	VS 26	G 1	2	3800	124.0	157.0	113.0



400-447-117

400-447-142



1920.9B

Spare parts

Art. No.	Type No.	Description
100739	400-447-117	Solenoid 230 V AC / 50 Hz
100740	400-447-142	Solenoid 24 V DC
100409	1920.9B	Coupling socket form B, EN 175301-803

Start-up valves

»variobloc« series

PLUS

For slow pressure build-up in pneumatic systems, e.g. after an emergency stop. The valve opens to full flow at approximately 60% of the set operating pressure. The filling time can be set by turning the adjusting screw. Used in combination with multi-piece service units.

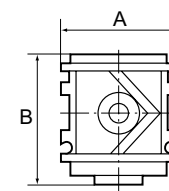
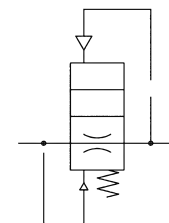

Operating pressure	2 - 25 bar
Flow rate measurement	At $P_1 = 6$ bar and pressure drop $\Delta p = 1$ bar

Start-up valve

Art. No.	Type No.	Thread	Size	Flow rate l/min	A mm	B mm
100742	VA 23	G 3/8	1	1400	48.0	54.0
100743	VA 24	G 1/2	2	3800	70.0	72.0
100744	VA 25	G 3/4	2	4200	70.0	72.0
100745	VA 26	G 1	2	4200	124.0	72.0



VA 23

Accessories / Fixing elements

Art. No.	Type No.	For types	Description
100746	630/1-B	G 1/4, G 3/8	Mounting bracket and fixing nut
100747	630/2-B	G 1/2, G 3/4, G 1	Mounting bracket and fixing nut
100748	VZ 718	G 1/4, G 3/8	Mounting bracket and two screws
100749	VZ 719	G 1/2, G 3/4, G 1	Mounting bracket and two screws
100750	VZ 101	G 1/4	Compact joiner set for assembling two devices
100751	VZ 102	G 3/8	Compact joiner set for assembling two devices
100752	VZ 103	G 1/2	Compact joiner set for assembling two devices
100753	VZ 104	G 3/4, G 1	Compact joiner set for assembling two devices
100754	VZ 201	G 1/4	Compact joiner set f. assembling 2 devices, incl. tee holder
100755	VZ 202	G 3/8	Compact joiner set f. assembling 2 devices, incl. tee holder
100756	VZ 203	G 1/2	Compact joiner set f. assembling 2 devices, incl. tee holder
100757	VZ 204	G 3/4, G 1	Compact joiner set f. assembling 2 devices, incl. tee holder
100758	VZ 301	G 1/4, G 3/8	Tee holder (separate)
100759	VZ 302	G 1/2, G 3/4, G 1	Tee holder (separate)
100760	VZ 401	G 1/4	Comfort joiner set as input/output module
100761	VZ 402	G 3/8	Comfort joiner set as input/output module
100762	VZ 500	G 1	Connection plate set f. converting devices from G 3/4 to G 1



630/1-B



VZ 718



VZ 104



VZ 202



VZ 301

VZ 401



VZ 500

1



Combined service units

PLUS

A filter, pressure regulator and oil-mist lubricator combined in a single device with an extremely compact design. The pressure setting can be locked by pushing the knob down. Oil can be filled under pressure.

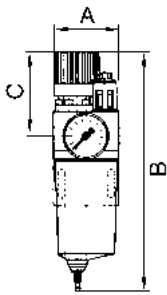

Max. input pressure	16 bar
Max. medium temperature	50 °C
Max. ambient temperature	50 °C
Housing	Die-cast zinc
Spring bonnet	PA
Sealant	NBR
Filter rating	50 µm
Sight dome	PA
Flow rate measurement	At $P_1 = 8$ bar, $P_2 = 6$ bar and pressure drop $\Delta p = 1$ bar



810.07 K

Combination service unit with polycarbonate bowl and manual drain valve

Art. No.	Type No.	Thread	Size	Control range bar	Flow rate l/min	A mm	B mm	C mm
101088	810.03 K	G 1/4	1	0,5 - 10	1400	67.0	217.0	68.5
101089	810.04 K	G 1/4	1	0,5 - 16	1000	67.0	217.0	68.5
101090	810.05 K	G 3/8	1	0,5 - 10	1400	67.0	217.0	68.5
101091	810.06 K	G 3/8	1	0,5 - 16	1000	67.0	217.0	68.5
101092	810.07 K	G 1/2	1	0,5 - 10	1400	65.0	217.0	68.5
101093	810.08 K	G 1/2	1	0,5 - 16	1000	65.0	217.0	68.5
101094	811.13 K	G 3/4	2	0,5 - 10	3400	97.0	296.5	96.5
101095	811.14 K	G 3/4	2	0,5 - 16	2800	97.0	296.5	96.5
101096	811.15 K	G 1	2	0,5 - 10	3400	93.0	296.5	96.5
101097	811.16 K	G 1	2	0,5 - 16	2800	93.0	296.5	96.5



810.07 S

Combination service unit with polycarbonate bowl, bowl guard and manual drain valve

Art. No.	Type No.	Thread	Size	Control range bar	Flow rate l/min	A mm	B mm	C mm
101098	810.03 S	G 1/4	1	0,5 - 10	1400	67.0	217.0	68.5
101099	810.04 S	G 1/4	1	0,5 - 16	1000	67.0	217.0	68.5
101100	810.05 S	G 3/8	1	0,5 - 10	1400	67.0	217.0	68.5
101101	810.06 S	G 3/8	1	0,5 - 16	1000	67.0	217.0	68.5
101102	810.07 S	G 1/2	1	0,5 - 10	1400	65.0	217.0	68.5
101103	810.08 S	G 1/2	1	0,5 - 16	1000	65.0	217.0	68.5
101104	811.13 S	G 3/4	2	0,5 - 10	3400	97.0	296.5	96.5
101105	811.14 S	G 3/4	2	0,5 - 16	2800	97.0	296.5	96.5
101106	811.15 S	G 1	2	0,5 - 10	3400	93.0	296.5	96.5
101107	811.16 S	G 1	2	0,5 - 16	2800	93.0	296.5	96.5



H 10

E 13810/24



SM 10

1412.7.909



810.6.950

VZ 722

Accessories / spare parts for combined service unit G 1/4, G 3/8 and G 1/2

Art. No.	Type No.	Description
101108	H 10	Holder with socket cap screws M5x20
101109	E 13810/24	Plastic bowl with automatic draining valve incl. O-ring
101111	SM 10	Metal bowl guard
100677	65/0-N	Fully-automatic drain valve
101112	22.810.4	Set of wearing parts
100711	1412.7.909	Sight dome, metal for G 1/2, G 3/4
101114	810.6.950	Filter element 50 µm, sintered bronze
100709	VZ 722	Sight dome, plastic for G 1/2, G 3/4, G 1

Accessories / spare parts for combined service unit G 3/4 and G 1

Art. No.	Type No.	Description
101116	H 11	Holder with socket cap screws M8x25
101117	E 14811/24	Plastic bowl with automatic draining valve incl. O-ring
101119	SM 11	Metal bowl guard

Accessories / spare parts for combined service unit G 3/4 and G 1

Art. No.	Type No.	Description
100677	65/0-N	Fully-automatic drain valve
101120	22.811.4	Set of wearing parts
100711	1412.7.909	Sight dome, metal for G 1/2, G 3/4
101121	811.6.950	Filter insert 40 µm, sintered bronze
100709	VZ 722	Sight dome, plastic for G 1/2, G 3/4, G 1



Service units

»ONE« series

PLUS

Multifunctional service unit with 6 or 7 functions in a single device:

3/2-way valve (manually operated), filter with automatic drain valve, air ports, pressure regulator, pressure gauge, soft start valve and optional pressure switch

This combination of extremely good flow rates and a wide range of functions integrated in a single, compact unit saves valuable space and is unmatched by any similar product available in the market! Soft starting independently of the load and easy replacement of the filter cartridge under pressure are just two of the other outstanding features of this amazing device.

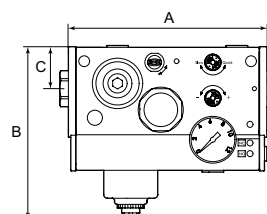

Max. input pressure	10 bar
Control range	0,5 - 8 bar
Filter rating	20 µm
Temperature range	-10 to 50 °C
Medium	Pneumatics
Protection IP	IP 65
Operating voltage	24 V DC (for valves and pressure switch)
Flow rate measurement	At P ₂ = 6.3 bar and pressure drop Δp = 1 bar

Service unit, »ONE« series, without pressure switch

Art. No.	Type No.	Thread	Flow rate l/min	A mm	B mm	C mm
101122	533.301	G 1/4	2400	165.5	144.0	35.0
101123	533.302	G 3/8	3300	165.5	144.0	35.0
101124	533.303	G 1/2	4000	165.5	144.0	35.0



533.303

Service unit, »ONE« series, with pressure switch (changeover contact)

Art. No.	Type No.	Thread	Flow rate l/min	A mm	B mm	C mm
101125	533.311	G 1/4	2400	165.5	144.0	35.0
101126	533.312	G 3/8	3300	165.5	144.0	35.0
101127	533.313	G 1/2	4000	165.5	144.0	35.0



533.313

→ This unit can also be supplied with many other combinations of functions and port sizes. We will be pleased to make you an offer to match your individual specification on request!

Accessories / spare parts

Art. No.	Type No.	Description
101130	533.1412	Threaded connection G 1/4
101131	533.3812	Threaded connection G 1/2
101132	533.901	Electric connection cable, straight wall outlet, 5 m cable
101133	533.902	Electric connection cable, 90° elbow wall outlet, 5 m cable
101134	533.906	Mounting bracket incl. 2 screws
101128	533.905	Filter element 5 µm
101129	533.900	Filter element 20 µm



Special filters »airclean«

three-stage filtration – pre-filter, micro-filter, activated carbon filter

NEW Pre-filters

Pre-filters »airclean«

PLUS

For filtering out solid impurities larger than 3 µm and for moisture separation.
For connection upstream of a micro-filter or a combination micro-filter/activated carbon filter.

Input pressure	4 - 16 bar
Medium temperature	1,5 to 80 °C
Ambient temperature	1,5 to 80 °C
Housing	Aluminium
filter bowl	Aluminium
Filter rating	1 µm
Particle separation	1 µm
Efficiency	99.99 %
Filter element	Borosilicate microfibreglass fabric
Flow rate measurement	At $P_1 = 7$ bar and pressure drop $\Delta p = 0.1$ bar



4381112



4381111

Pre-filter with differential pressure gauge

Art. No.	Type No.	Thread	Flow rate l/min	A mm	C mm	D mm
199801	4381112	G 1/4	583	80.0	23.5	327.0
199803	4381122	G 3/8	1000	80.0	23.5	327.0
199805	4381132	G 1/2	1500	104.0	28.0	399.0
199807	4381242	G 3/4	3666	104.0	28.0	399.0

Pre-filter without differential pressure gauge

Art. No.	Type No.	Thread	Flow rate l/min	A mm	C mm	D mm
199800	4381111	G 1/4	583	80.0	23.5	327.0
199802	4381121	G 3/8	1000	80.0	23.5	327.0
199804	4381131	G 1/2	1500	104.0	28.0	399.0
199806	4381241	G 3/4	3666	104.0	28.0	399.0

NEW Microfilters

Microfilters »airclean«

PLUS

Ideal for filtering out aerosols and solid impurities larger than 0.01 µm.
Micro-filters should always be used in conjunction with a pre-filter.

Input pressure	4 - 16 bar
Medium temperature	1,5 to 80 °C
Ambient temperature	1,5 to 80 °C
Housing	Aluminium
filter bowl	Aluminium
Filter rating	0.01 µm
Efficiency	99.99 %
Filter element	Borosilicate (with glass-fibre material and foam plastic)
Flow rate measurement	At $P_1 = 7$ bar and pressure drop $\Delta p = 0.1$ bar

Microfilter with differential pressure gauge

Art. No.	Type No.	Thread	Flow rate l/min	A mm	C mm	D mm
199809	4382112	G 1/4	583	80.0	23.5	327.0
199811	4382122	G 3/8	1000	80.0	23.5	327.0
199813	4382132	G 1/2	1500	104.0	28.0	399.0
199815	4382242	G 3/4	3666	104.0	28.0	399.0

Microfilter without differential pressure gauge

Art. No.	Type No.	Thread	Flow rate l/min	A mm	C mm	D mm
199808	4382111	G 1/4	583	80.0	23.5	327.0
199810	4382121	G 3/8	1000	80.0	23.5	327.0
199812	4382131	G 1/2	1500	104.0	28.0	399.0
199814	4382241	G 3/4	3666	104.0	28.0	399.0



4382112



4382111

NEW Activated carbon filters

Activated carbon filters »airclean«

PLUS

For adsorbing vaporous media.
A micro-filter must be connected upstream if dried air is not available.

Input pressure	0 - 16 bar
Medium temperature	1,5 to 80 °C
Ambient temperature	1,5 to 80 °C
Housing	Aluminium
filter bowl	Aluminium
Residual oil content	0.003 mg/m ³
Filter element	non-woven medium, impregnated with activated carbon
Flow rate measurement	At $P_1 = 7$ bar and pressure drop $\Delta p = 0.1$ bar

Activated carbon filter with differential pressure gauge

Art. No.	Type No.	Thread	Flow rate l/min	A mm	C mm	D mm
199817	4383112	G 1/4	583	80.0	23.5	327.0
199819	4383122	G 3/8	1000	80.0	23.5	327.0
199821	4383132	G 1/2	1500	104.0	28.0	399.0
199823	4383242	G 3/4	3666	104.0	28.0	399.0



4383112



NEW Activated carbon filters

Activated carbon filters »airclean«

PLUS



4383111

Activated carbon filter without differential pressure gauge

Art. No.	Type No.	Thread	Flow rate l/min	A mm	C mm	D mm
199816	4383111	G 1/4	583	80.0	23.5	327.0
199818	4383121	G 3/8	1000	80.0	23.5	327.0
199820	4383131	G 1/2	1500	104.0	28.0	399.0
199822	4383241	G 3/4	3666	104.0	28.0	399.0

Special filters P-M-A

three-stage filtration – pre-filter, micro-filter, activated carbon filter

For filtering out solid impurities larger than 3 µm and for moisture separation.

For connection upstream of a micro-filter or a combination micro-filter/activated carbon filter.

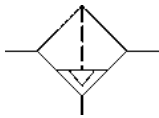

Pre-filter

Pre-filter »VMA«

PLUS

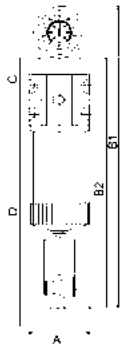

For filtering out solid impurities larger than 3 µm and for moisture separation.

For connection upstream of a micro-filter or a combination micro-filter/activated carbon filter.

Input pressure	4 - 16 bar
Medium temperature	5 to 60 °C
Ambient temperature	5 to 60 °C
Housing	Aluminium
filter bowl	Aluminium
Filter rating	3 µm
Particle separation	from 3 µm
Efficiency	99.99 %
Filter element	Polyethylene (with 45% cavity)
Flow rate measurement	At P ₁ = 6 bar and pressure drop Δ _p = 0.5%

Pre-filter with differential pressure gauge

Art. No.	Type No.	Thread	Flow rate l/min	A mm	B1 mm	B2 mm	C mm	D mm
101548	429.2309	G 1	3000	118.0	517.5	420.0	72.0	458.0
101549	429.2410	G 1 1/4	5300	118.0	617.5	520.0	72.0	658.0
101550	429.2511	G 1 1/2	8300	118.0	717.5	620.0	72.0	858.0
101551	429.2612	G 2	13000	118.0	907.5	810.0	72.0	1.238.0



429.2309

Pre-filter without differential pressure gauge

Art. No.	Type No.	Thread	Flow rate l/min	A mm	B2 mm	C mm	D mm
101556	429.5309	G 1	3000	118.0	420.0	72.0	458.0
101557	429.5410	G 1 1/4	5300	118.0	520.0	72.0	658.0
101558	429.5511	G 1 1/2	8300	118.0	620.0	72.0	858.0
101559	429.5612	G 2	13000	118.0	810.0	72.0	1.238.0

Accessories / spare parts for pre-filter		
Art. No.	Type No.	Description
101599	429/33	Joiner set for G 1 to G 2
101170	429/27	Mounting bracket with 2 screws for G 1 to G 2
101601	5429.10	Differential pressure gauge
101602	65/0-S	Automatic drain valve
101594	429/58	Filter element for G 1, made of borosilicate microfibre fabric
101595	429/59	Filter element for G 1 1/4, made of borosilicate microfibre fabric
101596	429/61	Filter element for G 1 1/2, made of borosilicate microfibre fabric
101597	429/62	Filter element for G 2, made of borosilicate microfibre fabric



Micro-filters

Microfilter »VMA«

PLUS

Ideal for filtering out aerosols and solid impurities larger than 0.01 µm. Micro-filters should always be used in conjunction with a pre-filter.

Input pressure	4 - 16 bar
Medium temperature	5 to 60 °C
Ambient temperature	5 to 60 °C
Housing	Aluminium
filter bowl	Aluminium
Filter rating	0.01 µm
Efficiency	99.9999 %
Filter element	Borosilicate (with glass-fibre material and foam plastic)
Flow rate measurement	At P ₁ = 6 bar and pressure drop Δ _p = 1.5%

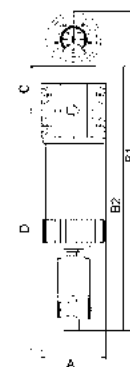
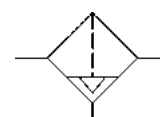

Micro-filter with differential pressure gauge

Art. No.	Type No.	Thread	Flow rate l/min	A mm	B1 mm	B2 mm	C mm	D mm
101564	430.2309	G 1	4080	118.0	517.5	420.0	72.0	458.0
101565	430.2410	G 1 1/4	4580	118.0	617.5	520.0	72.0	658.0
101566	430.2511	G 1 1/2	6500	118.0	717.5	620.0	72.0	858.0
101567	430.2612	G 2	9000	118.0	907.5	810.0	72.0	1.238.0



430.2309

Micro-filter without differential pressure gauge

Art. No.	Type No.	Thread	Flow rate l/min	A mm	B2 mm	C mm	D mm
101572	430.5309	G 1	4080	118.0	420.0	72.0	458.0
101573	430.5410	G 1 1/4	4580	118.0	520.0	72.0	658.0
101574	430.5511	G 1 1/2	6500	118.0	620.0	72.0	858.0
101575	430.5612	G 2	9000	118.0	810.0	72.0	1.238.0

Accessories / spare parts for micro-filter

Art. No.	Type No.	Description
101599	429/33	Joiner set for G 1 to G 2
101170	429/27	Mounting bracket with 2 screws for G 1 to G 2
101601	5429.10	Differential pressure gauge
101602	65/0-S	Automatic drain valve
101605	430/8	Filter element for G 1, from microfibre non-woven
101606	430/9	Filter element for G 1 1/4, from microfibre non-woven
101607	430/11	Filter element for G 1 1/2, from microfibre non-woven
101608	430/12	Filter element for G 2, from microfibre non-woven



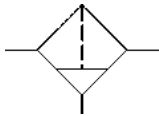

Activated carbon filters

Activated carbon filter »VMA«

PLUS

For adsorbing vaporous media.
A micro-filter must be connected upstream if dried air is not available.

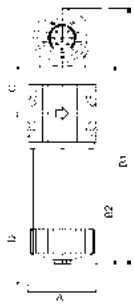

Input pressure	4 - 16 bar
Medium temperature	5 to 60 °C
Ambient temperature	5 to 60 °C
Housing	Aluminium
filter bowl	Aluminium
Residual oil content	0.005 mg/m ³
Filter element	Activated carbon
Flow rate measurement	At P ₁ = 6 bar and pressure drop Δ _p = 0.5%



431.3309

Activated carbon filter with differential pressure gauge

Art. No.	Type No.	Thread	Flow rate l/min	A mm	B1 mm	B2 mm	C mm	D mm
101580	431.3309	G 1	1500	118.0	429.0	330.0	72.0	368.0
101581	431.3410	G 1 1/4	2650	118.0	529.0	430.0	72.0	568.0
101582	431.3511	G 1 1/2	4150	118.0	629.0	530.0	72.0	768.0
101583	431.3612	G 2	6650	118.0	819.0	720.0	72.0	1.148.0

Activated carbon filter without differential pressure gauge

Art. No.	Type No.	Thread	Flow rate l/min	A mm	B2 mm	C mm	D mm
101588	431.5309	G 1	1500	118.0	330.0	72.0	368.0
101589	431.5410	G 1 1/4	2650	118.0	430.0	72.0	568.0
101590	431.5511	G 1 1/2	4150	118.0	530.0	72.0	768.0
101591	431.5612	G 2	6650	118.0	720.0	72.0	1.148.0



429/33

429/27



5429.10



65/0-S



431/8

Accessories / spare parts for activated carbon filter

Art. No.	Type No.	Description
101599	429/33	Joiner set for G 1 to G 2
101170	429/27	Mounting bracket with 2 screws for G 1 to G 2
101601	5429.10	Differential pressure gauge
101602	65/0-S	Automatic drain valve
101611	431/8	Filter element for G 1, finely ground activated carbon
101612	431/9	Filter element for G 1 1/4, finely ground activated carbon
101613	431/11	Filter element for G 1 1/2, finely ground activated carbon
101614	431/12	Filter element for G 2, finely ground activated carbon

Pressure regulators

»FUTURA-mini« series

MAX

Diaphragm pressure regulators with self-relieving design and with excellent flow rates in modern design. The regulator knob can be latched.

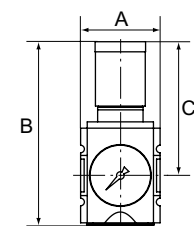
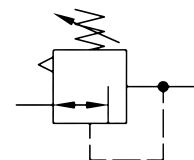

Max. input pressure	12 bar
Temperature range	-10 to 50 °C
Medium	Compressed air, neutral gases
Housing	PA66 GF60
Connecting thread	Plastic
Sealant	NBR
Diaphragms	NBR
Flow rate	1000 l/min
Flow rate measurement	At $P_1 = 10$ bar, $P_2 = 6.3$ bar and pressure drop $\Delta p = 1$ bar
Size	0

Pressure regulator with standard pressure gauge

Art. No.	Type No.	Thread	Control range bar	Pressure gauge display bar	A mm	B mm	C mm
142396	FUM 7004	G 1/4	0,1 - 4	0 - 6	43.0	88.0	63.0
142397	FUM 7008	G 1/4	0,5 - 8	0 - 10	43.0	88.0	63.0
142398	FUM 7010	G 1/4	0,5 - 10	0 - 16	43.0	88.0	63.0



FUM 7008

Pressure regulator with compact pressure gauge

Art. No.	Type No.	Thread	Control range bar	Pressure gauge display bar	A mm	B mm	C mm
142399	FUM 7004-KM	G 1/4	0,1 - 4	0 - 6	43.0	88.0	63.0
142400	FUM 7008-KM	G 1/4	0,5 - 8	0 - 12	43.0	88.0	63.0
142401	FUM 7010-KM	G 1/4	0,5 - 10	0 - 12	43.0	88.0	63.0



FUM 7008-KM

Accessories / spare parts

Art. No.	Type No.	Description
143102	R 11-55 K	Panel nut M30x1.5
143105	H 848	Mounting bracket, incl. 2 screws
143106	H 849	Mounting bracket for thread for panel mounting
143010	WKM 100	Coupling package for wall mounting incl. 2 screws and O-ring
143022	KPM 100	Coupling package incl. 2 screws and O-ring
152077	WK 100-14	Wall bracket with connection thread G 1/4
143119	7010.4.950M	Replacement diaphragm for pressure regulator, G 1/4
143131	1811.3.904	Wheel 0.1 - 4 bar
143136	1811.5.904	Pressure spring 0 - 4 bar
143140	22.7010M.4	Spare parts for filter regulator/regulator
143132	1811.3.908	Wheel 0.5 - 8 bar
143138	1811.5.908	Pressure spring 0 - 8 bar
117242	1811.3.910	Wheel 0.5 - 10 bar
117251	1811.5.910	Pressure spring 0 - 10 bar
152301	KM6	Compact pressure gauge 0 - 6 bar
152298	KM12	Compact pressure gauge 0 - 12 bar



R 11-55 K WK 100-14

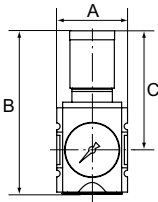
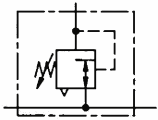

Pressure regulators with continuous pressure supply

»FUTURA-mini« series

MAX

Diaphragm pressure regulators with self-relieving design and excellent flow rates in modern design for mounting side by side.

By assembling two or more controllers together, it is possible to supply several working air circuits with different output pressures via a single supply line. The regulator button can be latched.

Max. input pressure	12 bar
Temperature range	-10 to 50 °C
Medium	Compressed air, neutral gases
Housing	PA66 GF60
Connecting thread	Plastic
Sealant	NBR
Diaphragms	NBR
Flow rate	1000 l/min
Flow rate measurement	At $P_1 = 10$ bar, $P_2 = 6.3$ bar and pressure drop $\Delta p = 1$ bar
Size	0

Pressure regulator with continuous pressure supply, standard pressure gauge

Art. No.	Type No.	Thread	Control range bar	Pressure gauge display bar	A mm	B mm	C mm
142402	FUM 7204	G 1/4	0,1 - 4	0 - 6	43.0	93.0	68.0
142403	FUM 7208	G 1/4	0,5 - 8	0 - 10	43.0	93.0	68.0
142404	FUM 7210	G 1/4	0,5 - 10	0 - 16	43.0	93.0	68.0



FUM 7208

Pressure regulator with continuous pressure supply, compact pressure gauge

Art. No.	Type No.	Thread	Control range bar	Pressure gauge display bar	A mm	B mm	C mm
142405	FUM 7204-KM	G 1/4	0,1 - 4	0 - 6	43.0	93.0	68.0
142406	FUM 7208-KM	G 1/4	0,5 - 8	0 - 12	43.0	93.0	68.0
142407	FUM 7210-KM	G 1/4	0,5 - 10	0 - 12	43.0	93.0	68.0



FUM 7208-KM

→ The port for the output pressure (P2) is at the bottom! G 1/4



R 11-55 K

Accessories / spare parts

Art. No.	Type No.	Description
143102	R 11-55 K	Panel nut M30x1.5
143105	H 848	Mounting bracket, incl. 2 screws
143106	H 849	Mounting bracket for thread for panel mounting
143010	WKM 100	Coupling package for wall mounting incl. 2 screws and O-ring
143022	KPM 100	Coupling package incl. 2 screws and O-ring
152077	WK 100-14	Wall bracket with connection thread G 1/4
143131	1811.3.904	Wheel 0.1 - 4 bar
143136	1811.5.904	Pressure spring 0 - 4 bar
143140	22.7010M.4	Spare parts for filter regulator/regulator
143119	7010.4.950M	Replacement diaphragm for pressure regulator, G 1/4
143132	1811.3.908	Wheel 0.5 - 8 bar
143138	1811.5.908	Pressure spring 0 - 8 bar
117242	1811.3.910	Wheel 0.5 - 10 bar
117251	1811.5.910	Pressure spring 0 - 10 bar
152301	KM6	Compact pressure gauge 0 - 6 bar
152298	KM12	Compact pressure gauge 0 - 12 bar

Filter regulators

»FUTURA-mini« series

MAX

Filter regulators with excellent flow rates in modern design.
The regulator knob can be latched.

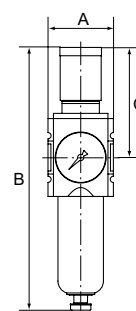
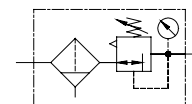

Input pressure	1.5 - 12 bar
Temperature range	-10 to 50 °C
Medium	Compressed air, neutral gases
Housing	PA66 GF60
Connecting thread	Plastic
Filter element	Cellpor (PE)
Filter rating	5 µm
Sealant	NBR
Diaphragms	NBR
Flow rate	1000 l/min
Flow rate measurement	At $P_1 = 10$ bar, $P_2 = 6.3$ bar and pressure drop $\Delta p = 1$ bar
Size	0

Filter regulator with polycarbonate bowl and standard pressure gauge

Art. No.	Type No.	Thread	Control range bar	Pressure gauge display bar	Condensate drain	A mm	B mm	C mm
142408	FUM 811-4	G 1/4	0,1 - 4	0 - 6	Semi-automatic	43.0	168.0	63.0
142409	FUM 811-8	G 1/4	0,5 - 8	0 - 10	Semi-automatic	43.0	168.0	63.0
142410	FUM 811-10	G 1/4	0,5 - 10	0 - 16	Semi-automatic	43.0	168.0	63.0
142411	FUM 821-4	G 1/4	0,1 - 4	0 - 6	Fully-automatic	43.0	206.0	63.0
142412	FUM 821-8	G 1/4	0,5 - 8	0 - 10	Fully-automatic	43.0	206.0	63.0
142413	FUM 821-10	G 1/4	0,5 - 10	0 - 16	Fully-automatic	43.0	206.0	63.0



FUM 811-8

Filter regulator with polycarbonate bowl and compact pressure gauge

Art. No.	Type No.	Thread	Control range bar	Pressure gauge display bar	Condensate drain	A mm	B mm	C mm
142417	FUM 811-4-KM	G 1/4	0,1 - 4	0 - 6	Semi-automatic	43.0	168.0	63.0
142418	FUM 811-8-KM	G 1/4	0,5 - 8	0 - 12	Semi-automatic	43.0	168.0	63.0
142419	FUM 811-10-KM	G 1/4	0,5 - 10	0 - 12	Semi-automatic	43.0	168.0	63.0
142420	FUM 821-4-KM	G 1/4	0,1 - 4	0 - 6	Fully-automatic	43.0	206.0	63.0
142421	FUM 821-8-KM	G 1/4	0,5 - 8	0 - 12	Fully-automatic	43.0	206.0	63.0
142422	FUM 821-10-KM	G 1/4	0,5 - 10	0 - 12	Fully-automatic	43.0	206.0	63.0



FUM 821-8

FUM 821-8-KM

Accessories / spare parts

Art. No.	Type No.	Description
143102	R 11-55 K	Panel nut M30x1.5
143105	H 848	Mounting bracket, incl. 2 screws
143106	H 849	Mounting bracket for thread for panel mounting
143010	WKM 100	Coupling package for wall mounting incl. 2 screws and O-ring
143022	KPM 100	Coupling package incl. 2 screws and O-ring
100357	640/1-HA	Polycarbonate bowl (filter)
152077	WK 100-14	Wall bracket with connection thread G 1/4
100361	KS 11 F-A	Polycarbonate bowl with automatic draining
100134	611.6.905	Filter element 5 µm, Cellpor
143119	7010.4.950M	Replacement diaphragm for pressure regulator, G 1/4
118137	302.4.9	O-ring 30x2 mm for container
143131	1811.3.904	Wheel 0.1 - 4 bar
143136	1811.5.904	Pressure spring 0 - 4 bar
143140	22.7010M.4	Spare parts for filter regulator/regulator
100362	655.6.900	Automatic drain valve
143132	1811.3.908	Wheel 0.5 - 8 bar



R 11-55 K



640/1-HA



WK 102-12



KS 11 F-A



611.6.905



655.6.900

Accessories / spare parts

Art. No.	Type No.	Description
143138	1811.5.908	Pressure spring 0 - 8 bar
117242	1811.3.910	Wheel 0.5 - 10 bar
117251	1811.5.910	Pressure spring 0 - 10 bar
152301	KM6	Compact pressure gauge 0 - 6 bar
152298	KM12	Compact pressure gauge 0 - 12 bar

Filters

»FUTURA-mini« series

MAX

Filters with excellent flow rates in modern design.

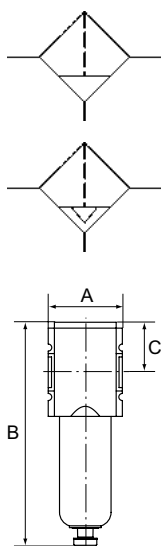

Input pressure	1.5 - 12 bar
Temperature range	-10 to 50 °C
Medium	Compressed air, neutral gases
Housing	PA66 GF60
Connecting thread	Plastic
Sealant	NBR
Filter element	Cellpor (PE)
Filter rating	5 µm
Flow rate	1000 l/min
Flow rate measurement	At P ₂ = 6 bar and pressure drop Δ _p = 1 bar
Size	0

Filter with polycarbonate bowl



Art. No.	Type No.	Thread	Condensate drain	A mm	B mm	C mm
142438	FUM 831	G 1/4	Semi-automatic	43.0	132.0	27.0
142439	FUM 841	G 1/4	Fully-automatic	43.0	170.0	27.0
142440	FUM 841-C	G 1/4	Fully-automatic (NC)	43.0	170.0	27.0

Accessories / spare parts



Art. No.	Type No.	Description
143105	H 848	Mounting bracket, incl. 2 screws
143010	WKM 100	Coupling package for wall mounting incl. 2 screws and O-ring
143022	KPM 100	Coupling package incl. 2 screws and O-ring
100357	640/1-HA	Polycarbonate bowl (filter)
152077	WK 100-14	Wall bracket with connection thread G 1/4
100361	KS 11 F-A	Polycarbonate bowl with automatic draining
100134	611.6.905	Filter element 5 µm, Cellpor
118137	302.4.9	O-ring 30x2 mm for container
100362	655.6.900	Automatic drain valve

Pre-filters

»FUTURA-mini« series

MAX

Pre-filters in modern design for compliance with strict compressed air purity requirements. Pre-filters are used to separate solid impurities up to 0.3 µm from compressed air and gases.

Input pressure	1.5 - 12 bar
Temperature range	-10 to 50 °C
Medium	Compressed air, neutral gases
Housing	PA66 GF60
Connecting thread	Plastic
Sealant	NBR
Filter element	Impregnated paper
Filter rating	0.3 µm
Flow rate	140 l/min
Flow rate measurement	At P ₂ = 6 bar and pressure drop Δ _p = 0.02 bar
Size	0

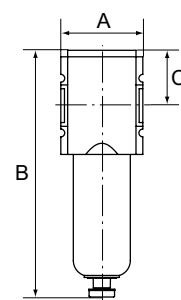
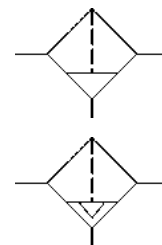

Pre-filter with polycarbonate bowl

Art. No.	Type No.	Thread	Condensate drain	A mm	B mm	C mm
142443	FUM 851	G 1/4	Semi-automatic	43.0	132.0	27.0
142444	FUM 861	G 1/4	Fully-automatic	43.0	170.0	27.0



Accessories / spare parts

Art. No.	Type No.	Description
143105	H 848	Mounting bracket, incl. 2 screws
143010	WKM 100	Coupling package for wall mounting incl. 2 screws and O-ring
143022	KPM 100	Coupling package incl. 2 screws and O-ring
100379	V 23/35	Pre-filter element (paper-POM)
100357	640/1-HA	Polycarbonate bowl (filter)
152077	WK 100-14	Wall bracket with connection thread G 1/4
100361	KS 11 F-A	Polycarbonate bowl with automatic draining
118137	302.4.9	O-ring 30x2 mm for container
100362	655.6.900	Automatic drain valve



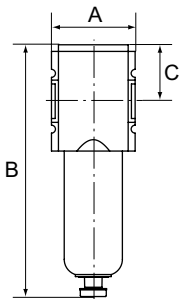
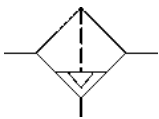
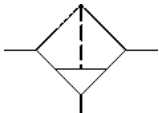

Micro-filters (fine-filters)

»FUTURA-mini« series

MAX

Micro-filters in modern design for compliance with strict compressed air purity requirements. Micro-filters are used to separate solid oil, water and solid impurities as small as 0.01 µm from compressed air and gases.

Input pressure	1.5 - 12 bar
Temperature range	-10 to 50 °C
Medium	Compressed air, neutral gases
Housing	PA66 GF60
Connecting thread	Plastic
Sealant	NBR
Filter element	Borosilicate glass fibre
Filter rating	0.01 µm
Residual oil content	< 0.01 mg/m ³
Dust separation	> 0.01 µm 99.999 %
Flow rate	190 l/min
Flow rate measurement	At P ₂ = 6 bar and pressure drop Δ _p = 0.1 bar
Size	0



FUM 871 FUM 881

Micro-filter with polycarbonate bowl

Art. No.	Type No.	Thread	Condensate drain	A mm	B mm	C mm
142448	FUM 871	G 1/4	Semi-automatic	43.0	132.0	27.0
142449	FUM 881	G 1/4	Fully-automatic	43.0	170.0	27.0



M 23/40 640/1-HA



KS 11 F-A 655.6.900

Accessories / spare parts

Art. No.	Type No.	Description
143105	H 848	Mounting bracket, incl. 2 screws
143010	WKM 100	Coupling package for wall mounting incl. 2 screws and O-ring
143022	KPM 100	Coupling package incl. 2 screws and O-ring
100381	M 23/40	Micro-filter element (borosilicate-POM)
100357	640/1-HA	Polycarbonate bowl (filter)
152077	WK 100-14	Wall bracket with connection thread G 1/4
100361	KS 11 F-A	Polycarbonate bowl with automatic draining
118137	302.4.9	O-ring 30x2 mm for container
100362	655.6.900	Automatic drain valve

Activated carbon filters

»FUTURA-mini« series

MAX

Activated carbon filters in modern design for compliance with strict compressed air purity requirements. Activated carbon filters are used to absorb oil vapour up to a residual oil content of 0.005 mg/m³ from compressed air and gases.

Input pressure	0 - 12 bar
Temperature range	-10 to 50 °C
Medium	Compressed air, neutral gases
Housing	PA66 GF60
Connecting thread	Plastic
Sealant	NBR
Filter element	Activated carbon
Residual oil content	0.005 mg/m ³
Flow rate	470 l/min
Flow rate measurement	At P ₂ = 6 bar and pressure drop Δp = 0.2 bar
Size	0

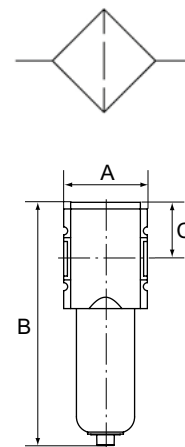

Activated carbon filter with polycarbonate bowl

Art. No.	Type No.	Thread	A mm	B mm	C mm
142453	FUM 891	G 1/4	43.0	125.0	27.0



FUM 891

Accessories / spare parts

Art. No.	Type No.	Description
143105	H 848	Mounting bracket, incl. 2 screws
143010	WKM 100	Coupling package for wall mounting incl. 2 screws and O-ring
143022	KPM 100	Coupling package incl. 2 screws and O-ring
100384	A 23/60	Filter element (activated carbon POM)
100383	740/01	Polycarbonate bowl (lubricator)
152077	WK 100-14	Wall bracket with connection thread G 1/4
118137	302.4.9	O-ring 30x2 mm for container



740/01



A 23/60

1

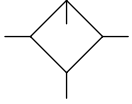

Oil-mist lubricators

»FUTURA-mini« series

MAX

Oil-mist lubricators with excellent flow rates in modern design.

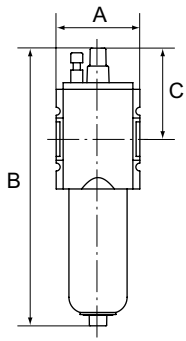

FUM 901

Max. input pressure	12 bar
Temperature range	-10 to 50 °C
Medium	Compressed air, neutral gases
Housing	PA66 GF60
Connecting thread	Plastic
Sight dome	PC
Sealant	NBR
Oil grade	CL 32 acc. to DIN 51517-ISO VG 32
Flow rate	1500 l/min
Flow rate measurement	At $P_2 = 6$ bar and pressure drop $\Delta p = 1$ bar
Size	0

Oil-mist lubricator with polycarbonate bowl

Art. No.	Type No.	Thread	A mm	B mm	C mm
142455	FUM 901	G 1/4	43.0	156.0	58.0

→ We recommend our special pneumatic oil on page 145

Accessories / spare parts

Art. No.	Type No.	Description
143105	H 848	Mounting bracket, incl. 2 screws
143010	WKM 100	Coupling package for wall mounting incl. 2 screws and O-ring
143022	KPM 100	Coupling package incl. 2 screws and O-ring
100383	740/01	Polycarbonate bowl (lubricator)
152077	WK 100-14	Wall bracket with connection thread G 1/4
118137	302.4.9	O-ring 30x2 mm for container
100214	901.7.990	Sight dome, polycarbonate



740/01



901.7.990

Service units

two-piece, »FUTURA-mini« series

MAX

Two-piece service units with excellent flow rates in modern design.
Diaphragm pressure regulator with secondary ventilation.

Input pressure	1.5 - 12 bar
Temperature range	-10 to 50 °C
Medium	Compressed air, neutral gases
Housing	PA66 GF60
Connecting thread	Plastic
Filter element	Cellpor (PE)
Filter rating	5 µm
Sight dome	PC
Sealant	NBR
Diaphragms	NBR
Flow rate	800 l/min
Flow rate measurement	At $P_1 = 10$ bar, $P_2 = 6.3$ bar and pressure drop $\Delta p = 1$ bar
Size	0

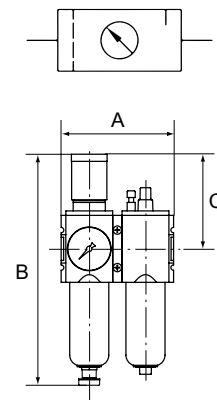

FUM 601-8



FUM 611-8



FUM 601-8-KM



FUM 611-8-KM



R 11-55 K 611.6.905

Service unit, 2-piece with polycarbonate bowl and standard pressure gauge

Art. No.	Type No.	Thread	Control range bar	Pressure gauge display bar	Condensate drain	A mm	B mm	C mm
142457	FUM 601-4	G 1/4	0,1 - 4	0 - 6	Semi-automatic	86.0	168.0	63.0
142458	FUM 601-8	G 1/4	0,5 - 8	0 - 10	Semi-automatic	86.0	168.0	63.0
142459	FUM 601-10	G 1/4	0,5 - 10	0 - 16	Semi-automatic	86.0	168.0	63.0
142460	FUM 611-4	G 1/4	0,1 - 4	0 - 6	Fully-automatic	86.0	206.0	63.0
142461	FUM 611-8	G 1/4	0,5 - 8	0 - 10	Fully-automatic	86.0	206.0	63.0
142462	FUM 611-10	G 1/4	0,5 - 10	0 - 16	Fully-automatic	86.0	206.0	63.0

Service unit, 2-piece with polycarbonate bowl and compact pressure gauge

Art. No.	Type No.	Thread	Control range bar	Pressure gauge display bar	Condensate drain	A mm	B mm	C mm
142466	FUM 601-4-KM	G 1/4	0,1 - 4	0 - 6	Semi-automatic	86.0	168.0	63.0
142467	FUM 601-8-KM	G 1/4	0,5 - 8	0 - 12	Semi-automatic	86.0	168.0	63.0
142468	FUM 601-10-KM	G 1/4	0,5 - 10	0 - 12	Semi-automatic	86.0	168.0	63.0
142469	FUM 611-4-KM	G 1/4	0,1 - 4	0 - 6	Fully-automatic	86.0	206.0	63.0
142470	FUM 611-8-KM	G 1/4	0,5 - 8	0 - 12	Fully-automatic	86.0	206.0	63.0
142471	FUM 611-10-KM	G 1/4	0,5 - 10	0 - 12	Fully-automatic	86.0	206.0	63.0

→ We recommend our special pneumatic oil on page 145

Accessories / spare parts

Art. No.	Type No.	Description
143102	R 11-55 K	Panel nut M30x1.5
143105	H 848	Mounting bracket, incl. 2 screws
143106	H 849	Mounting bracket for thread for panel mounting
143010	WKM 100	Coupling package for wall mounting incl. 2 screws and O-ring
143022	KPM 100	Coupling package incl. 2 screws and O-ring
100134	611.6.905	Filter element 5 µm, Cellpor
100357	640/1-HA	Polycarbonate bowl (filter)
100383	740/01	Polycarbonate bowl (lubricator)
152077	WK 100-14	Wall bracket with connection thread G 1/4
100361	KS 11 F-A	Polycarbonate bowl with automatic draining
118137	302.4.9	O-ring 30x2 mm for container
143131	1811.3.904	Wheel 0.1 - 4 bar
143136	1811.5.904	Pressure spring 0 - 4 bar
143140	22.7010M.4	Spare parts for filter regulator/regulator
100362	655.6.900	Automatic drain valve
100214	901.7.990	Sight dome, polycarbonate

Accessories / spare parts

Art. No.	Type No.	Description
143132	1811.3.908	Wheel 0.5 - 8 bar
143138	1811.5.908	Pressure spring 0 - 8 bar
117242	1811.3.910	Wheel 0.5 - 10 bar
117251	1811.5.910	Pressure spring 0 - 10 bar
152301	KM6	Compact pressure gauge 0 - 6 bar
152298	KM12	Compact pressure gauge 0 - 12 bar

Service units

three-piece, »FUTURA-mini« series

MAX

Three-piece service units with excellent flow rates in modern design. Diaphragm pressure regulator with secondary ventilation.

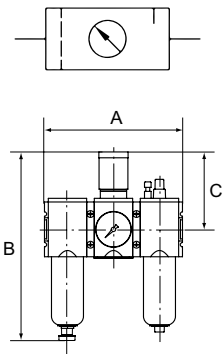

Input pressure	1.5 - 12 bar
Temperature range	-10 to 50 °C
Medium	Compressed air, neutral gases
Housing	PA66 GF60
Connecting thread	Plastic
Filter element	Cellpor (PE)
Filter rating	5 µm
Sight dome	PC
Sealant	NBR
Diaphragms	NBR
Flow rate	800 l/min
Flow rate measurement	At P ₁ = 10 bar, P ₂ = 6.3 bar and pressure drop Δ _p = 1 bar
Size	0



FUM 621-8



FUM 633-8



FUM 621-8-KM



FUM 633-8-KM

Service unit, 3-piece with polycarbonate bowl and standard pressure gauge

Art. No.	Type No.	Thread	Control range bar	Pressure gauge display bar	Condensate drain	A mm	B mm	C mm
142481	FUM 621-4	G 1/4	0,1 - 4	0 - 6	Semi-automatic	129.0	168.0	63.0
142482	FUM 621-8	G 1/4	0,5 - 8	0 - 10	Semi-automatic	129.0	168.0	63.0
142483	FUM 621-10	G 1/4	0,5 - 10	0 - 16	Semi-automatic	129.0	168.0	63.0
142484	FUM 633-4	G 1/4	0,1 - 4	0 - 6	Fully-automatic	129.0	206.0	63.0
142485	FUM 633-8	G 1/4	0,5 - 8	0 - 10	Fully-automatic	129.0	206.0	63.0
142486	FUM 633-10	G 1/4	0,5 - 10	0 - 16	Fully-automatic	129.0	206.0	63.0

Service unit, 3-piece with polycarbonate bowl and compact pressure gauge

Art. No.	Type No.	Thread	Control range bar	Pressure gauge display bar	Condensate drain	A mm	B mm	C mm
142490	FUM 621-4-KM	G 1/4	0,1 - 4	0 - 6	Semi-automatic	129.0	168.0	63.0
142491	FUM 621-8-KM	G 1/4	0,5 - 8	0 - 12	Semi-automatic	129.0	168.0	63.0
142492	FUM 621-10-KM	G 1/4	0,5 - 10	0 - 12	Semi-automatic	129.0	168.0	63.0
142493	FUM 633-4-KM	G 1/4	0,1 - 4	0 - 6	Fully-automatic	129.0	206.0	63.0
142494	FUM 633-8-KM	G 1/4	0,5 - 8	0 - 12	Fully-automatic	129.0	206.0	63.0
142495	FUM 633-10-KM	G 1/4	0,5 - 10	0 - 12	Fully-automatic	129.0	206.0	63.0

→ We recommend our special pneumatic oil on page 145

Accessories / spare parts		
Art. No.	Type No.	Description
143102	R 11-55 K	Panel nut M30x1.5
143105	H 848	Mounting bracket, incl. 2 screws
143106	H 849	Mounting bracket for thread for panel mounting
143010	WKM 100	Coupling package for wall mounting incl. 2 screws and O-ring
143022	KPM 100	Coupling package incl. 2 screws and O-ring
100134	611.6.905	Filter element 5 µm, Cellpor
100357	640/1-HA	Polycarbonate bowl (filter)
100383	740/01	Polycarbonate bowl (lubricator)
152077	WK 100-14	Wall bracket with connection thread G 1/4
100361	KS 11 F-A	Polycarbonate bowl with automatic draining
118137	302.4.9	O-ring 30x2 mm for container
143131	1811.3.904	Wheel 0.1 - 4 bar
143136	1811.5.904	Pressure spring 0 - 4 bar
143140	22.7010M.4	Spare parts for filter regulator/regulator
100362	655.6.900	Automatic drain valve
100214	901.7.990	Sight dome, polycarbonate
143119	7010.4.950M	Replacement diaphragm for pressure regulator, G 1/4
143132	1811.3.908	Wheel 0.5 - 8 bar
143138	1811.5.908	Pressure spring 0 - 8 bar
117242	1811.3.910	Wheel 0.5 - 10 bar
117251	1811.5.910	Pressure spring 0 - 10 bar
152301	KM6	Compact pressure gauge 0 - 6 bar
152298	KM12	Compact pressure gauge 0 - 12 bar



R 11-55 K



640/1-HA

740/01



KS 11 F-A

655.6.900



901.7.990



Manifold

»FUTURA-mini« series

MAX

Max. input pressure	12 bar
Temperature range	-10 to 50 °C
Medium	Compressed air, neutral gases
Housing	PA66 GF60
Connecting thread	Plastic
Flow rate	1 → 2 2700 l/min, 1 → 2.1 950 l/min, 1 → 2.2 2000 l/min
Flow rate measurement	At P ₂ = 6 bar and pressure drop Δ _p = 1 bar
Size	0

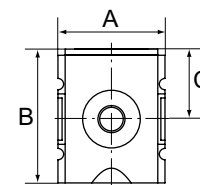
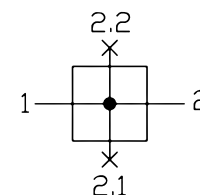

Manifold						
Art. No.	Type No.	Thread	Outlet	A mm	B mm	C mm
142517	FUM 941	G 1/4	2 x G 1/4	43.0	57.0	29.0



FUM 941

Accessories / spare parts		
Art. No.	Type No.	Description
143105	H 848	Mounting bracket, incl. 2 screws
143010	WKM 100	Coupling package for wall mounting incl. 2 screws and O-ring
143022	KPM 100	Coupling package incl. 2 screws and O-ring
152077	WK 100-14	Wall bracket with connection thread G 1/4

1

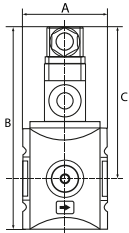
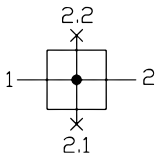

FUM 941-DS10



DS 9410 22.DS9410.4



1920.11P4

Manifold with pressure switch

»FUTURA-mini« series

MAX

Max. input pressure	12 bar
Temperature range	-10 to 50 °C
Medium	Compressed air, neutral gases
Housing	PA66 GF60
Connecting thread	Plastic
Flow rate	1 → 2 2700 l/min, 1 → 2.1 950 l/min, 1 → 2.2 2000 l/min
Flow rate measurement	At $P_2 = 6$ bar and pressure drop $\Delta p = 1$ bar
Size	0

Manifold with pressure switch

Art. No.	Type No.	Thread	Outlet	Adjustment range bar	A mm	B mm	C mm
142518	FUM 941-DS10	G 1/4	2 x G 1/4	0.5 - 10	43.0	127.0	99.0

Accessories / spare parts

Art. No.	Type No.	Description
143105	H 848	Mounting bracket, incl. 2 screws
143010	WKM 100	Coupling package for wall mounting incl. 2 screws and O-ring
143022	KPM 100	Coupling package incl. 2 screws and O-ring
152077	WK 100-14	Wall bracket with connection thread G 1/4
100280	DS 9410	Pressure switches - suitable for flange mounting
100281	22.DS9410.4	Moulded seal for flanged pressure switch
100282	1920.11P4	Coupling socket for pressure switch

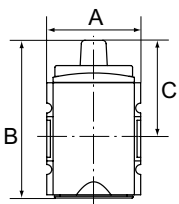
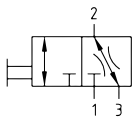

Ball valve (3/2-way)

»FUTURA-mini« series

MAX

Lockable ball valve, 3/2-way type including silencer, mechanically operated.

Rotary switch can be turned 90°, with indication of positions:

Horizontal: Input closed - outlet exhausted

Vertical: Flow open - exhaust closed

Exhaust air can be collected.

Max. input pressure	12 bar
Temperature range	-10 to 50 °C
Medium	Compressed air, neutral gases
Housing	PA66 GF60
Connecting thread	Plastic
Flow rate	2300 l/min
Flow rate measurement	At $P_2 = 6$ bar and pressure drop $\Delta p = 1$ bar
Size	0

Ball valve (3/2-way)

Art. No.	Type No.	Thread	Exhaust air	A mm	B mm	C mm
142519	FUM 951	G 1/4	G 1/4	43.0	87.0	51.0



FUM 951

→ The price does not include a padlock. Please order separately.

Ball valve (3/2-way)

»FUTURA-mini« series



568-2



Accessories / spare parts		
Art. No.	Type No.	Description
143105	H 848	Mounting bracket, incl. 2 screws
143010	WKM 100	Coupling package for wall mounting incl. 2 screws and O-ring
143022	KPM 100	Coupling package incl. 2 screws and O-ring
100405	568-2	Silencer
152077	WK 100-14	Wall bracket with connection thread G 1/4

3/2-way valves, electrically operated

»FUTURA-mini« series

MAX

Pneumatic systems or parts of systems can be switched on and off by means of an electrical signal. 3/2-way type including silencer. When they are switched off, the system is exhausted at the same time.

Input pressure	2.5 - 10 bar
Temperature range	-10 to 50 °C
Medium	Compressed air, neutral gases
Duty cycle	100 %
Pick-up power with 50 Hz AC voltage	2.2 VA
Holding power with 50 Hz AC voltage	1.6 VA
Power input	2.5 Watt with DC voltage
Protection IP	IP 65
Electrical connection	Socket coupling EN 175301-803, form C, poles 2+PE
Housing	PA66 GF60
Connecting thread	Plastic
Flow rate	2000 l/min
Flow rate measurement	At $P_2 = 6$ bar and pressure drop $\Delta p = 1$ bar
Size	0

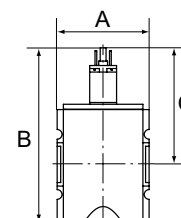
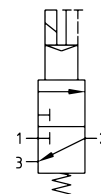

3/2-way valve, electrically operated, with 24 V DC, 2.5 W solenoid

Art. No.	Type No.	Thread	Exhaust air	A mm	B mm	C mm
142520	FUM 923	G 1/4	G 1/4	43.0	138.0	93.0

3/2-way valve, electrically operated, with 230 V AC, 50 Hz solenoid

Art. No.	Type No.	Thread	Exhaust air	A mm	B mm	C mm
142522	FUM 927	G 1/4	G 1/4	43.0	138.0	93.0



FUM 927

Accessories / spare parts

Art. No.	Type No.	Description
143105	H 848	Mounting bracket, incl. 2 screws
143010	WKM 100	Coupling package for wall mounting incl. 2 screws and O-ring
143022	KPM 100	Coupling package incl. 2 screws and O-ring
100405	568-2	Silencer
152077	WK 100-14	Wall bracket with connection thread G 1/4
100306	400-900-42	Pilot valve 24 V DC
100308	400-900-17	Pilot valve 230 V AC
100310	1920.FU	Connector type C



400-900-42 400-900-17



1920.FU

1

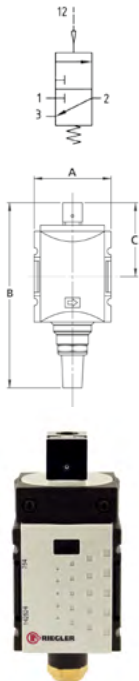

FUM 921



568-2

3/2-way valve, pneumatically operated

»FUTURA-mini« series

MAX

Pneumatic systems or parts of systems can be switched on and off by means of an pneumatic signal. 3/2-way type including silencer. When they are switched off, the system is exhausted at the same time.

Max. input pressure	12 bar
Temperature range	-10 to 50 °C
Medium	Compressed air, neutral gases
Housing	PA66 GF60
Connecting thread	Plastic
Flow rate	2000 l/min
Flow rate measurement	At $P_2 = 6$ bar and pressure drop $\Delta p = 1$ bar
Size	0

3/2-way valve, pneumatically operated

Art. No.	Type No.	Thread	Pilot air connection	Exhaust air	A mm	B mm	C mm
142524	FUM 921	G 1/4	G 1/8	G 1/4	43.0	105.0	60.0

Accessories / spare parts

Art. No.	Type No.	Description
143105	H 848	Mounting bracket, incl. 2 screws
143010	WKM 100	Coupling package for wall mounting incl. 2 screws and O-ring
143022	KPM 100	Coupling package incl. 2 screws and O-ring
100405	568-2	Silencer
152077	WK 100-14	Wall bracket with connection thread G 1/4

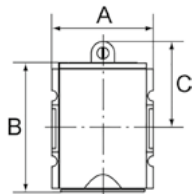
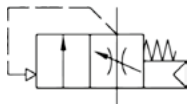

FUM 931

Filling valve (start-up valve)

»FUTURA-mini« series

MAX

Seat valves operated by secondary pressure for controlled pressurisation of pneumatic systems. These valves prevent a sudden build-up of pressure accompanied by dangerous, jerky cylinder movements. The full cross-section of the regulator is opened at 50% of the input pressure. The filling time can be altered by turning the adjusting screw.

Input pressure	2.5 - 12 bar
Temperature range	-10 to 50 °C
Medium	Compressed air, neutral gases
Housing	PA66 GF60
Connecting thread	Plastic
Flow rate	2000 l/min
Flow rate measurement	At $P_2 = 6$ bar and pressure drop $\Delta p = 1$ bar
Size	0

Filling valve (start-up valve)

Art. No.	Type No.	Thread	A mm	B mm	C mm
142525	FUM 931	G 1/4	43.0	81.0	53.0

➔ More technical data see 3/2-way valve and filling unit

Filling valve (start-up valve)

»FUTURA-mini« series

Accessories / spare parts		
Art. No.	Type No.	Description
143105	H 848	Mounting bracket, incl. 2 screws
143010	WKM 100	Coupling package for wall mounting incl. 2 screws and O-ring
143022	KPM 100	Coupling package incl. 2 screws and O-ring
152077	WK 100-14	Wall bracket with connection thread G 1/4

Filling units, electrically operated

»FUTURA-mini« series

MAX

The filling unit protects devices connected downstream by ensuring a gradual build-up of pressure. The unit consists of a 3/2-way valve including silencer and a filling valve (start-up valve). It is connected and disconnected by means of the 3/2-way valve. The filling time can be altered by turning the adjusting screw.

Input pressure	2.5 - 10 bar
Temperature range	-10 to 50 °C
Medium	Compressed air, neutral gases
Duty cycle	100 %
Pick-up power with 50 Hz AC voltage	2.2 VA
Holding power with 50 Hz AC voltage	1.6 VA
Power input	2.5 Watt with DC voltage
Protection IP	IP 65
Electrical connection	Socket coupling EN 175301-803, form C, poles 2+PE
Housing	PA66 GF60
Connecting thread	Plastic
Flow rate	1400 l/min
Flow rate measurement	At $P_2 = 6$ bar and pressure drop $\Delta p = 1$ bar
Size	0

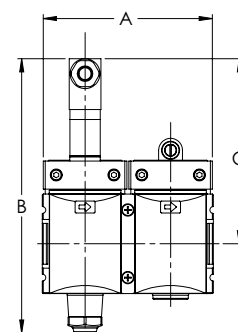
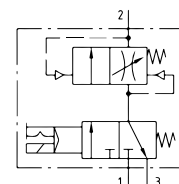

FUM 913

Filling unit, electrically operated, with 24 V DC, 2.5 W solenoid, adjustable filling time						
Art. No.	Type No.	Thread	Exhaust air	A	B	C
142526	FUM 913	G 1/4	G 1/4	86.0	138.0	93.0

Filling unit, electrically operated, with 230 V AC, 50 Hz solenoid, adjustable filling time						
Art. No.	Type No.	Thread	Exhaust air	A	B	C
142527	FUM 917	G 1/4	G 1/4	86.0	138.0	93.0

Accessories / spare parts		
Art. No.	Type No.	Description
143105	H 848	Mounting bracket, incl. 2 screws
143010	WKM 100	Coupling package for wall mounting incl. 2 screws and O-ring
143022	KPM 100	Coupling package incl. 2 screws and O-ring
100405	568-2	Silencer
152077	WK 100-14	Wall bracket with connection thread G 1/4
100306	400-900-42	Pilot valve 24 V DC
100308	400-900-17	Pilot valve 230 V AC
100310	1920.FU	Connector type C



568-2



400-900-42



400-900-17



1920.FU

1

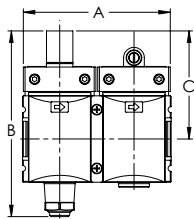
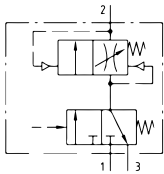

FUM 919



568-2

Filling unit, pneumatically operated

»FUTURA-mini« series

MAX

The filling unit protects devices connected downstream by ensuring a gradual build-up of pressure. The unit consists of a 3/2-way valve including silencer and a filling valve (start-up valve). It is connected and disconnected by means of the 3/2-way valve. The filling time can be altered by turning the adjusting screw.

Input pressure	2.5 - 12 bar
Temperature range	-10 to 50 °C
Medium	Compressed air, neutral gases
Housing	PA66 GF60
Connecting thread	Plastic
Flow rate	1400 l/min
Flow rate measurement	At $P_2 = 6$ bar and pressure drop $\Delta p = 1$ bar
Size	0

Filling unit, pneumatically operated, adjustable filling time

Art. No.	Type No.	Thread	A mm	B mm	C mm
142529	FUM 919	G 1/4	86.0	105.0	60.0

Accessories / spare parts

Art. No.	Type No.	Description
143105	H 848	Mounting bracket, incl. 2 screws
143010	WKM 100	Coupling package for wall mounting incl. 2 screws and O-ring
143022	KPM 100	Coupling package incl. 2 screws and O-ring
100405	568-2	Silencer
152077	WK 100-14	Wall bracket with connection thread G 1/4

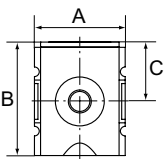
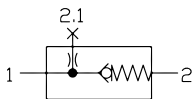

FUM 9401

Non-return valve

»FUTURA-mini« series

MAX

Input pressure	0.4 - 12 bar
Temperature range	-10 to 50 °C
Medium	Compressed air, neutral gases
Housing	PA66 GF60
Sealant	NBR
Connecting thread	Plastic
Flow rate	1 → 2 750 l/min, 1 → 2.1 1000 l/min
Flow rate measurement	At $P_2 = 6$ bar and pressure drop $\Delta p = 1$ bar
Size	0

Non-return valve

Art. No.	Type No.	Thread	A mm	B mm	C mm
142531	FUM 9401	G 1/4	43.0	66.0	27.0

Accessories / spare parts

Art. No.	Type No.	Description
143105	H 848	Mounting bracket, incl. 2 screws
143010	WKM 100	Coupling package for wall mounting incl. 2 screws and O-ring
143022	KPM 100	Coupling package incl. 2 screws and O-ring
152077	WK 100-14	Wall bracket with connection thread G 1/4

Pressure regulators

»FUTURA« series

MAX

Diaphragm pressure regulators with self-relieving design and with excellent flow rates in modern design. The regulator knob can be latched and locked.

Max. input pressure	16 bar
Temperature range	-10 to 50 °C
Medium	Compressed air, neutral gases
Housing	PA66 GF60
Connecting thread	Material: Die-cast zinc
Sealant	NBR
Diaphragms	NBR
Flow rate measurement	At $P_1 = 10$ bar, $P_2 = 6.3$ bar and pressure drop $\Delta p = 1$ bar

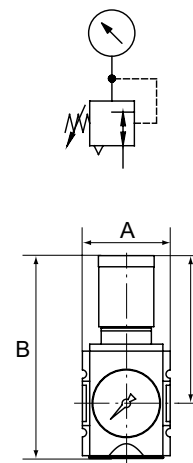

Pressure regulator incl. pressure gauge

Art. No.	Type No.	Thread	Size	Control range bar	Pressure gauge display bar	Flow rate l/min	A mm	B mm	C mm
100003	FU 7004	G 1/4	1	0,2 - 4	0 - 6	2000	52.0	129.0	96.0
100004	FU 7008	G 1/4	1	0,5 - 8	0 - 10	2000	52.0	129.0	96.0
100005	FU 7010	G 1/4	1	0,5 - 10	0 - 16	2000	52.0	129.0	96.0
100006	FU 7016	G 1/4	1	0,5 - 16	0 - 25	2000	52.0	129.0	96.0
100009	FU 7104	G 3/8	1	0,2 - 4	0 - 6	2500	52.0	129.0	96.0
100010	FU 7108	G 3/8	1	0,5 - 8	0 - 10	2500	52.0	129.0	96.0
100011	FU 7110	G 3/8	1	0,5 - 10	0 - 16	2500	52.0	129.0	96.0
100012	FU 7116	G 3/8	1	0,5 - 16	0 - 25	2500	52.0	129.0	96.0
100015	FU 7154	G 3/8	2	0,2 - 4	0 - 6	4500	63.0	150.0	110.0
100016	FU 7158	G 3/8	2	0,5 - 8	0 - 10	4500	63.0	150.0	110.0
100017	FU 7160	G 3/8	2	0,5 - 10	0 - 16	4500	63.0	150.0	110.0
100018	FU 7166	G 3/8	2	0,5 - 16	0 - 25	4500	63.0	150.0	110.0
100021	FU 7174	G 1/2	2	0,2 - 4	0 - 6	5200	63.0	150.0	110.0
100022	FU 7178	G 1/2	2	0,5 - 8	0 - 10	5200	63.0	150.0	110.0
100023	FU 7180	G 1/2	2	0,5 - 10	0 - 16	5200	63.0	150.0	110.0
100024	FU 7186	G 1/2	2	0,5 - 16	0 - 25	5200	63.0	150.0	110.0
100027	FU 7184	G 3/4	4	0,2 - 4	0 - 6	14200	85.0	191.0	137.0
100028	FU 7188	G 3/4	4	0,5 - 8	0 - 10	14200	85.0	191.0	137.0
100029	FU 7190	G 3/4	4	0,5 - 10	0 - 16	14200	85.0	191.0	137.0
100030	FU 7196	G 3/4	4	0,5 - 16	0 - 25	14200	85.0	191.0	137.0
100033	FU 71104	G 1	4	0,2 - 4	0 - 6	14200	85.0	191.0	137.0
100034	FU 71108	G 1	4	0,5 - 8	0 - 10	14200	85.0	191.0	137.0
100035	FU 71110	G 1	4	0,5 - 10	0 - 16	14200	85.0	191.0	137.0
100036	FU 71116	G 1	4	0,5 - 16	0 - 25	14200	85.0	191.0	137.0



FU 7008



FU 7008 + SS 32

→ The price does not include a key lock. Please order separately.

→ Internal air consumption at size 4 (G 3/4 and G 1): max. 1.5 l/min (depending on secondary pressure)

Accessories / spare parts for pressure regulator G 1/4 and G 3/8 (Size 1)

Art. No.	Type No.	Description
100038	H 850	Mounting bracket, incl. 2 screws
100039	WK 100	Wall bracket, incl. 2 screws
100040	KP 100	Joiner set, incl. 2 screws
100041	FU 11-55	Panel nut M36x1.5
100037	SS 32	Key lock
135851	WK 101-14	Wall bracket with connection thread G 1/4
135852	WK 101-38	Wall bracket with connection thread G 3/8
152945	H 851	Mounting bracket with control panel nut M36x1.5
100042	22.7010.4	Seal kit for pressure regulator



1



Accessories / spare parts for pressure regulator G 3/8 and G 1/2 (Size 2)

Art. No.	Type No.	Description
100043	H 852	Mounting bracket, incl. 2 screws
100044	WK 102	Wall bracket, incl. 2 screws
100045	KP 200	Joiner set, incl. 2 screws
100046	FU 33-55	Panel nut M42x1.5
100037	SS 32	Key lock
100331	WK 102-38	Wall bracket with connection thread G 3/8
100332	WK 102-12	Wall bracket with connection thread G 1/2
100333	WK 102-34	Wall bracket with connection thread G 3/4
152946	H 853	Mounting bracket with control panel nut M42x1.5
100047	22.7180.4	Seal kit for pressure regulator

Accessories / spare parts for pressure regulator G 3/4 and G 1 (Size 4)

Art. No.	Type No.	Description
100048	H 854	Mounting bracket, incl. 2 screws
100049	WK 103	Wall bracket, incl. 2 screws
100050	KP 300	Joiner set, incl. 2 screws
100037	SS 32	Key lock
135853	WK 104-34	Wall bracket with connection thread G 3/4
135854	WK 104-1	Wall bracket with connection thread G 1
100051	22.71110.4	Seal kit for pressure regulator

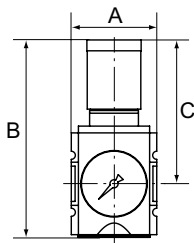
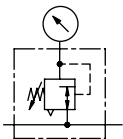

Pressure regulators with continuous pressure supply

»FUTURA« series

MAX

Diaphragm pressure regulators with self-relieving design and excellent flow rates in modern design for mounting side by side.

By assembling two or more controllers together, it is possible to supply several working air circuits with different output pressures via a single supply line.

The regulator button can be latched and locked.

Max. input pressure	16 bar
Temperature range	-10 to 50 °C
Medium	Compressed air, neutral gases
Housing	PA66 GF60
Connecting thread	Material: Die-cast zinc
Sealant	NBR
Diaphragms	NBR
Flow rate measurement	At $P_1 = 10$ bar, $P_2 = 6.3$ bar and pressure drop $\Delta p = 1$ bar



FU 7208

Pressure regulator with continuous pressure supply, incl. pressure gauge

Art. No.	Type No.	Thread	Size	Control range bar	Pressure gauge display bar	Flow rate l/min	A mm	B mm	C mm
100054	FU 7204	G 1/4	1	0,2 - 4	0 - 6	2000	52.0	129.0	96.0
100055	FU 7208	G 1/4	1	0,5 - 8	0 - 10	2000	52.0	129.0	96.0
114589	FU 7210	G 1/4	1	0,5 - 10	0 - 16	2000	52.0	129.0	96.0
100057	FU 7216	G 1/4	1	0,5 - 16	0 - 25	2000	52.0	129.0	96.0
100060	FU 7304	G 3/8	1	0,2 - 4	0 - 6	2500	52.0	129.0	96.0
100061	FU 7308	G 3/8	1	0,5 - 8	0 - 10	2500	52.0	129.0	96.0
100062	FU 7310	G 3/8	1	0,5 - 10	0 - 16	2500	52.0	129.0	96.0
100063	FU 7316	G 3/8	1	0,5 - 16	0 - 25	2500	52.0	129.0	96.0
100066	FU 7254	G 3/8	2	0,2 - 4	0 - 6	4500	63.0	150.0	110.0
100067	FU 7258	G 3/8	2	0,5 - 8	0 - 10	4500	63.0	150.0	110.0

Pressure regulators with continuous pressure supply

»FUTURA« series

MAX

Pressure regulator with continuous pressure supply, incl. pressure gauge

Art. No.	Type No.	Thread	Size	Control range bar	Pressure gauge display bar	Flow rate l/min	A mm	B mm	C mm
100068	FU 7260	G 3/8	2	0,5 - 10	0 - 16	4500	63.0	150.0	110.0
100069	FU 7266	G 3/8	2	0,5 - 16	0 - 25	4500	63.0	150.0	110.0
100072	FU 7274	G 1/2	2	0,2 - 4	0 - 6	5200	63.0	150.0	110.0
100073	FU 7278	G 1/2	2	0,5 - 8	0 - 10	5200	63.0	150.0	110.0
100074	FU 7280	G 1/2	2	0,5 - 10	0 - 16	5200	63.0	150.0	110.0
100075	FU 7286	G 1/2	2	0,5 - 16	0 - 25	5200	63.0	150.0	110.0

→ The price does not include a key lock. Please order separately.

→ The port for the output pressure (P2) is on the rear!

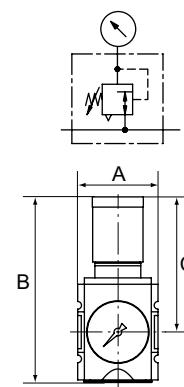

FU 7208 + SS 32



Accessories / spare parts for pressure regulator G 1/4 and G 3/8 (Size 1)

Art. No.	Type No.	Description
100038	H 850	Mounting bracket, incl. 2 screws
100039	WK 100	Wall bracket, incl. 2 screws
100040	KP 100	Joiner set, incl. 2 screws
100041	FU 11-55	Panel nut M36x1.5
100037	SS 32	Key lock
135851	WK 101-14	Wall bracket with connection thread G 1/4
135852	WK 101-38	Wall bracket with connection thread G 3/8
152945	H 851	Mounting bracket with control panel nut M36x1.5
100042	22.7010.4	Seal kit for pressure regulator



Accessories / spare parts for pressure regulator G 3/8 and G 1/2 (Size 2)

Art. No.	Type No.	Description
100043	H 852	Mounting bracket, incl. 2 screws
100044	WK 102	Wall bracket, incl. 2 screws
100045	KP 200	Joiner set, incl. 2 screws
100046	FU 33-55	Panel nut M42x1.5
100037	SS 32	Key lock
100331	WK 102-38	Wall bracket with connection thread G 3/8
100332	WK 102-12	Wall bracket with connection thread G 1/2
100333	WK 102-34	Wall bracket with connection thread G 3/4
152946	H 853	Mounting bracket with control panel nut M42x1.5
100047	22.7180.4	Seal kit for pressure regulator

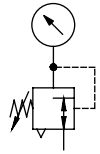

Precision pressure regulators

»FUTURA« series

MAX

Precision diaphragm pressure regulators with self-relieving design and excellent flow rates in modern design for applications requiring an extremely accurate working pressure. The regulator button can be latched and locked.

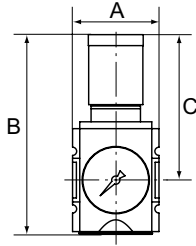

Max. input pressure	16 bar
Temperature range	-10 to 50 °C
Medium	Compressed air, neutral gases
Housing	PA66 GF60
Connecting thread	Material: Die-cast zinc
Sealant	NBR
Diaphragms	NBR
Max. internal air consumption	2.6 l/min (depending on secondary pressure)
Flow rate measurement	At $P_1 = 10$ bar, $P_2 = 6.3$ bar and pressure drop $\Delta p = 1$ bar



FU 7408



FU 7408 + SS 32

Precision pressure regulator incl. pressure gauge

Art. No.	Type No.	Thread	Size	Control range bar	Pressure gauge display bar	Flow rate l/min	A mm	B mm	C mm
100076	FU 7401	G 1/4	1	0,1 - 1	0 - 1,6	2200	52.0	129.0	96.0
100077	FU 7402	G 1/4	1	0,1 - 2	0 - 2,5	2200	52.0	129.0	96.0
100078	FU 7404	G 1/4	1	0,2 - 4	0 - 6	2200	52.0	129.0	96.0
100079	FU 7408	G 1/4	1	0,5 - 8	0 - 10	2200	52.0	129.0	96.0
100080	FU 7410	G 1/4	1	0,5 - 10	0 - 16	2200	52.0	129.0	96.0
100081	FU 7501	G 3/8	1	0,1 - 1	0 - 1,6	2750	52.0	129.0	96.0
100082	FU 7502	G 3/8	1	0,1 - 2	0 - 2,5	2750	52.0	129.0	96.0
100083	FU 7504	G 3/8	1	0,2 - 4	0 - 6	2750	52.0	129.0	96.0
100084	FU 7508	G 3/8	1	0,5 - 8	0 - 10	2750	52.0	129.0	96.0
100085	FU 7510	G 3/8	1	0,5 - 10	0 - 16	2750	52.0	129.0	96.0
100086	FU 7521	G 3/8	2	0,1 - 1	0 - 1,6	4500	63.0	150.0	110.0
100087	FU 7522	G 3/8	2	0,1 - 2	0 - 2,5	4500	63.0	150.0	110.0
100088	FU 7524	G 3/8	2	0,2 - 4	0 - 6	4500	63.0	150.0	110.0
100089	FU 7528	G 3/8	2	0,5 - 8	0 - 10	4500	63.0	150.0	110.0
100090	FU 7530	G 3/8	2	0,5 - 10	0 - 16	4500	63.0	150.0	110.0
100091	FU 7541	G 1/2	2	0,1 - 1	0 - 1,6	5200	63.0	150.0	110.0
100092	FU 7542	G 1/2	2	0,1 - 2	0 - 2,5	5200	63.0	150.0	110.0
100093	FU 7544	G 1/2	2	0,2 - 4	0 - 6	5200	63.0	150.0	110.0
100094	FU 7548	G 1/2	2	0,5 - 8	0 - 10	5200	63.0	150.0	110.0
100095	FU 7550	G 1/2	2	0,5 - 10	0 - 16	5200	63.0	150.0	110.0

- ➔ You can find suitable filters on page 125-126
- ➔ The price does not include a key lock. Please order separately.
- ➔ This controller is only allowed to be operated with micro-filtered air (filter rating 0.01 µm).



Accessories / spare parts for precision pressure regulator G 1/4 and G 3/8 (Size 1)

Art. No.	Type No.	Description
100038	H 850	Mounting bracket, incl. 2 screws
100039	WK 100	Wall bracket, incl. 2 screws
100040	KP 100	Joiner set, incl. 2 screws
100041	FU 11-55	Panel nut M36x1.5
100037	SS 32	Key lock
135851	WK 101-14	Wall bracket with connection thread G 1/4
135852	WK 101-38	Wall bracket with connection thread G 3/8
152945	H 851	Mounting bracket with control panel nut M36x1.5
100096	22.7410.4	Set of seals for precision pressure regulator

Accessories / spare parts for precision pressure regulator G 3/8 and G 1/2 (Size 2)

Art. No.	Type No.	Description
100043	H 852	Mounting bracket, incl. 2 screws
100044	WK 102	Wall bracket, incl. 2 screws
100045	KP 200	Joiner set, incl. 2 screws
100046	FU 33-55	Panel nut M42x1.5
100037	SS 32	Key lock
100331	WK 102-38	Wall bracket with connection thread G 3/8
100332	WK 102-12	Wall bracket with connection thread G 1/2
100333	WK 102-34	Wall bracket with connection thread G 3/4
152946	H 853	Mounting bracket with control panel nut M42x1.5
100097	22.7548.4	Set of seals for precision pressure regulator



Precision pressure regulators with continuous pressure supply

»FUTURA« series

MAX

Precision diaphragm pressure regulators with self-relieving design and excellent flow rates in modern design for mounting side by side.

By assembling two or more controllers together, it is possible to supply several working air circuits with different pressures via a single supply line.

Max. input pressure	16 bar
Temperature range	-10 to 50 °C
Medium	Compressed air, neutral gases
Housing	PA66 GF60
Connecting thread	Material: Die-cast zinc
Sealant	NBR
Diaphragms	NBR
Max. internal air consumption	2.6 l/min (depending on secondary pressure)
Flow rate measurement	At $P_1 = 10$ bar, $P_2 = 6.3$ bar and pressure drop $\Delta_p = 1$ bar

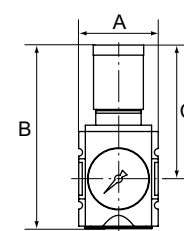
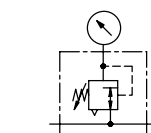

Precision pressure regulator with continuous pressure supply, incl. pressure gauge

Art. No.	Type No.	Thread	Size	Control range bar	Pressure gauge display bar	Flow rate l/min	A mm	B mm	C mm
100098	FU 7601	G 1/4	1	0,1 - 1	0 - 1,6	2200	52.0	129.0	96.0
100099	FU 7602	G 1/4	1	0,1 - 2	0 - 2,5	2200	52.0	129.0	96.0
100100	FU 7604	G 1/4	1	0,2 - 4	0 - 6	2200	52.0	129.0	96.0
100101	FU 7608	G 1/4	1	0,5 - 8	0 - 10	2200	52.0	129.0	96.0
100102	FU 7610	G 1/4	1	0,5 - 10	0 - 16	2200	52.0	129.0	96.0
100103	FU 7701	G 3/8	1	0,1 - 1	0 - 1,6	2750	52.0	129.0	96.0
100104	FU 7702	G 3/8	1	0,1 - 2	0 - 2,5	2750	52.0	129.0	96.0
100105	FU 7704	G 3/8	1	0,2 - 4	0 - 6	2750	52.0	129.0	96.0
100106	FU 7708	G 3/8	1	0,5 - 8	0 - 10	2750	52.0	129.0	96.0
100107	FU 7710	G 3/8	1	0,5 - 10	0 - 16	2750	52.0	129.0	96.0
100108	FU 7711	G 3/8	2	0,1 - 1	0 - 1,6	4500	63.0	150.0	110.0
100109	FU 7712	G 3/8	2	0,1 - 2	0 - 2,5	4500	63.0	150.0	110.0
100110	FU 7714	G 3/8	2	0,2 - 4	0 - 6	4500	63.0	150.0	110.0
100111	FU 7718	G 3/8	2	0,5 - 8	0 - 10	4500	63.0	150.0	110.0
100112	FU 7720	G 3/8	2	0,5 - 10	0 - 16	4500	63.0	150.0	110.0
100113	FU 7731	G 1/2	2	0,1 - 1	0 - 1,6	5200	63.0	150.0	110.0
100114	FU 7732	G 1/2	2	0,1 - 2	0 - 2,5	5200	63.0	150.0	110.0
100115	FU 7734	G 1/2	2	0,2 - 4	0 - 6	5200	63.0	150.0	110.0
100116	FU 7738	G 1/2	2	0,5 - 8	0 - 10	5200	63.0	150.0	110.0
100117	FU 7740	G 1/2	2	0,5 - 10	0 - 16	5200	63.0	150.0	110.0



FU 7604



FU 7608 + SS 32

- ➔ You can find suitable filters on page 127-128
- ➔ The price does not include a key lock. Please order separately.
- ➔ This controller is only allowed to be operated with micro-filtered air (filter rating 0.01 µm).
- ➔ The port for the output pressure (P2) is on the rear!

1



Accessories / spare parts for precision pressure regulator G 1/4 and G 3/8 (Size 1)

Art. No.	Type No.	Description
100038	H 850	Mounting bracket, incl. 2 screws
100039	WK 100	Wall bracket, incl. 2 screws
100040	KP 100	Joiner set, incl. 2 screws
100041	FU 11-55	Panel nut M36x1.5
100037	SS 32	Key lock
135851	WK 101-14	Wall bracket with connection thread G 1/4
135852	WK 101-38	Wall bracket with connection thread G 3/8
152945	H 851	Mounting bracket with control panel nut M36x1.5
100096	22.7410.4	Set of seals for precision pressure regulator

Accessories / spare parts for precision pressure regulator G 3/8 and G 1/2 (Size 2)

Art. No.	Type No.	Description
100043	H 852	Mounting bracket, incl. 2 screws
100044	WK 102	Wall bracket, incl. 2 screws
100045	KP 200	Joiner set, incl. 2 screws
100046	FU 33-55	Panel nut M42x1.5
100037	SS 32	Key lock
100331	WK 102-38	Wall bracket with connection thread G 3/8
100332	WK 102-12	Wall bracket with connection thread G 1/2
100333	WK 102-34	Wall bracket with connection thread G 3/4
152946	H 853	Mounting bracket with control panel nut M42x1.5
100097	22.7548.4	Set of seals for precision pressure regulator

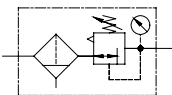

Filter regulators

»FUTURA« series

MAX

Filter regulators with excellent flow rates in modern design. The regulator knob can be latched and locked.

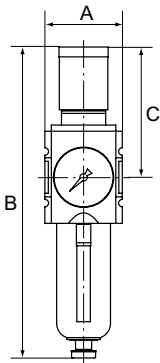

Input pressure	1.5 - 16 bar
Temperature range	-10 to 50 °C
Medium	Compressed air, neutral gases
Housing	PA66 GF60
Connecting thread	Material: Die-cast zinc
Filter element	Cellpor (PE)
Filter rating	5 µm
Sealant	NBR
Diaphragms	NBR
Flow rate measurement	At P ₁ = 10 bar, P ₂ = 6.3 bar and pressure drop Δ _p = 1 bar



FU 811

Filter regulator with polycarbonate bowl, bowl guard and pressure gauge

Art. No.	Type No.	Thread	Size	Control range bar	Pressure gauge display bar	Flow rate l/min	Condensate drain	A mm	B mm	C mm
151766	FU 811-4	G 1/4	1	0,2 - 4	0 - 6	2000	Semi-automatic	52.0	226.0	96.0
100118	FU 811	G 1/4	1	0,5 - 8	0 - 10	2000	Semi-automatic	52.0	226.0	96.0
151767	FU 811-10	G 1/4	1	0,5 - 10	0 - 16	2000	Semi-automatic	52.0	226.0	96.0
151768	FU 811-16	G 1/4	1	0,5 - 16	0 - 25	2000	Semi-automatic	52.0	226.0	96.0
151771	FU 812-4	G 3/8	1	0,2 - 4	0 - 6	2500	Semi-automatic	52.0	226.0	96.0
100119	FU 812	G 3/8	1	0,5 - 8	0 - 10	2500	Semi-automatic	52.0	226.0	96.0
151772	FU 812-10	G 3/8	1	0,5 - 10	0 - 16	2500	Semi-automatic	52.0	226.0	96.0
151773	FU 812-16	G 3/8	1	0,5 - 16	0 - 25	2500	Semi-automatic	52.0	226.0	96.0

Filter regulators

»FUTURA« series

MAX

Filter regulator with polycarbonate bowl, bowl guard and pressure gauge

Art. No.	Type No.	Thread	Size	Control range bar	Pressure gauge display bar	Flow rate l/min	Condensate drain	A mm	B mm	C mm
139498	FU 813-4	G 3/8	2	0,2 - 4	0 - 6	4500	Semi-automatic	63.0	257.0	110.0
100120	FU 813	G 3/8	2	0,5 - 8	0 - 10	4500	Semi-automatic	63.0	257.0	110.0
139499	FU 813-10	G 3/8	2	0,5 - 10	0 - 16	4500	Semi-automatic	63.0	257.0	110.0
139500	FU 813-16	G 3/8	2	0,5 - 16	0 - 25	4500	Semi-automatic	63.0	257.0	110.0
139503	FU 814-4	G 1/2	2	0,2 - 4	0 - 6	5200	Semi-automatic	63.0	257.0	110.0
100121	FU 814	G 1/2	2	0,5 - 8	0 - 10	5200	Semi-automatic	63.0	257.0	110.0
139504	FU 814-10	G 1/2	2	0,5 - 10	0 - 16	5200	Semi-automatic	63.0	257.0	110.0
139505	FU 814-16	G 1/2	2	0,5 - 16	0 - 25	5200	Semi-automatic	63.0	257.0	110.0
100122	FU 6110	G 3/4	4	0,5 - 8	0 - 10	13000	Semi-automatic	85.0	326.0	137.0
151777	FU 6110-10	G 3/4	4	0,5 - 10	0 - 16	13000	Semi-automatic	85.0	326.0	137.0
151778	FU 6110-16	G 3/4	4	0,5 - 16	0 - 25	13000	Semi-automatic	85.0	326.0	137.0
151781	FU 6111-4	G 1	4	0,2 - 4	0 - 6	13000	Semi-automatic	85.0	326.0	137.0
100123	FU 6111	G 1	4	0,5 - 8	0 - 10	13000	Semi-automatic	85.0	326.0	137.0
151782	FU 6111-10	G 1	4	0,5 - 10	0 - 16	13000	Semi-automatic	85.0	326.0	137.0
151783	FU 6111-16	G 1	4	0,5 - 16	0 - 25	13000	Semi-automatic	85.0	326.0	137.0
151786	FU 821-4	G 1/4	1	0,2 - 4	0 - 6	2000	Fully-automatic	52.0	243.0	96.0
100124	FU 821	G 1/4	1	0,5 - 8	0 - 10	2000	Fully-automatic	52.0	243.0	96.0
151787	FU 821-10	G 1/4	1	0,5 - 10	0 - 16	2000	Fully-automatic	52.0	243.0	96.0
151788	FU 821-16	G 1/4	1	0,5 - 16	0 - 25	2000	Fully-automatic	52.0	243.0	96.0
151791	FU 822-4	G 3/8	1	0,2 - 4	0 - 6	2500	Fully-automatic	52.0	243.0	96.0
100125	FU 822	G 3/8	1	0,5 - 8	0 - 10	2500	Fully-automatic	52.0	243.0	96.0
151792	FU 822-10	G 3/8	1	0,5 - 10	0 - 16	2500	Fully-automatic	52.0	243.0	96.0
151793	FU 822-16	G 3/8	1	0,5 - 16	0 - 25	2500	Fully-automatic	52.0	243.0	96.0
151796	FU 823-4	G 3/8	2	0,2 - 4	0 - 6	4500	Fully-automatic	63.0	273.0	110.0
100126	FU 823	G 3/8	2	0,5 - 8	0 - 10	4500	Fully-automatic	63.0	273.0	110.0
151797	FU 823-10	G 3/8	2	0,5 - 10	0 - 16	4500	Fully-automatic	63.0	273.0	110.0
151798	FU 823-16	G 3/8	2	0,5 - 16	0 - 25	4500	Fully-automatic	63.0	273.0	110.0
151801	FU 824-4	G 1/2	2	0,2 - 4	0 - 6	5200	Fully-automatic	63.0	273.0	110.0
100127	FU 824	G 1/2	2	0,5 - 8	0 - 10	5200	Fully-automatic	63.0	273.0	110.0
151802	FU 824-10	G 1/2	2	0,5 - 10	0 - 16	5200	Fully-automatic	63.0	273.0	110.0
151803	FU 824-16	G 1/2	2	0,5 - 16	0 - 25	5200	Fully-automatic	63.0	273.0	110.0

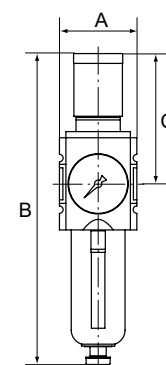
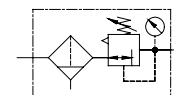

FU 821 + SS 32

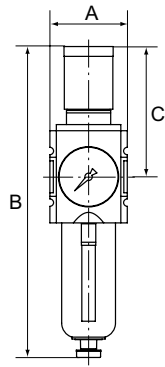
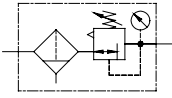

Filter regulators

»FUTURA« series

MAX

Filter regulator with polycarbonate bowl, bowl guard and pressure gauge

Art. No.	Type No.	Thread	Size	Control range bar	Pressure gauge display bar	Flow rate l/min	Condensate drain	A mm	B mm	C mm
151806	FU 6120-4	G 3/4	4	0,2 - 4	0 - 6	13000	Fully-automatic	85.0	343.0	137.0
100128	FU 6120	G 3/4	4	0,5 - 8	0 - 10	13000	Fully-automatic	85.0	343.0	137.0
151807	FU 6120-10	G 3/4	4	0,5 - 10	0 - 16	13000	Fully-automatic	85.0	343.0	137.0
151808	FU 6120-16	G 3/4	4	0,5 - 16	0 - 25	13000	Fully-automatic	85.0	343.0	137.0
151809	FU 6121-1	G 1	4	0,1 - 1	0 - 1,6	13000	Fully-automatic	85.0	343.0	137.0
151811	FU 6121-4	G 1	4	0,2 - 4	0 - 6	13000	Fully-automatic	85.0	343.0	137.0
100129	FU 6121	G 1	4	0,5 - 8	0 - 10	13000	Fully-automatic	85.0	343.0	137.0
151812	FU 6121-10	G 1	4	0,5 - 10	0 - 16	13000	Fully-automatic	85.0	343.0	137.0
151813	FU 6121-16	G 1	4	0,5 - 16	0 - 25	13000	Fully-automatic	85.0	343.0	137.0

→ The price does not include a key lock. Please order separately.

→ Internal air consumption at size 4 (G 3/4 and G 1): max. 1.5 l/min (depending on secondary pressure)

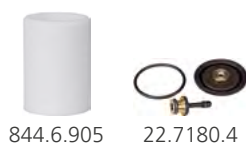

Accessories / spare parts for filter regulator G 1/4 and G 3/8 (Size 1)

Art. No.	Type No.	Description
100038	H 850	Mounting bracket, incl. 2 screws
100039	WK 100	Wall bracket, incl. 2 screws
100040	KP 100	Joiner set, incl. 2 screws
100130	BSF 14	Polycarbonate bowl, incl. bowl guard
100132	BSF 14-A	Polycarbonate bowl with automatic drain valve
100041	FU 11-55	Panel nut M36x1.5
100037	SS 32	Key lock
135851	WK 101-14	Wall bracket with connection thread G 1/4
135852	WK 101-38	Wall bracket with connection thread G 3/8
152945	H 851	Mounting bracket with control panel nut M36x1.5
100134	611.6.905	Filter element 5 µm, Cellpor
100042	22.7010.4	Seal kit for pressure regulator
100362	655.6.900	Automatic drain valve

Accessories / spare parts for filter regulator G 3/8 and G 1/2 (Size 2)

Art. No.	Type No.	Description
100043	H 852	Mounting bracket, incl. 2 screws
100044	WK 102	Wall bracket, incl. 2 screws
100045	KP 200	Joiner set, incl. 2 screws
100135	BSF 12	Polycarbonate bowl, incl. bowl guard
100137	BSF 12-A	Polycarbonate bowl with automatic drain valve
100046	FU 33-55	Panel nut M42x1.5
100037	SS 32	Key lock
100331	WK 102-38	Wall bracket with connection thread G 3/8
100332	WK 102-12	Wall bracket with connection thread G 1/2
100333	WK 102-34	Wall bracket with connection thread G 3/4
152946	H 853	Mounting bracket with control panel nut M42x1.5
100139	844.6.905	Filter element 5 µm, cellpor
100047	22.7180.4	Seal kit for pressure regulator
100362	655.6.900	Automatic drain valve

Accessories / spare parts for filter regulator G 3/4 and G 1 (Size 4)		
Art. No.	Type No.	Description
100048	H 854	Mounting bracket, incl. 2 screws
100049	WK 103	Wall bracket, incl. 2 screws
100050	KP 300	Joiner set, incl. 2 screws
100140	BSF 34	Polycarbonate bowl, incl. bowl guard
100142	BSF 34-A	Polycarbonate bowl with automatic drain valve
100037	SS 32	Key lock
135853	WK 104-34	Wall bracket with connection thread G 3/4
135854	WK 104-1	Wall bracket with connection thread G 1
100144	6141.6.905	Filter element 5 µm, Cellpor
100051	22.71110.4	Seal kit for pressure regulator
100362	655.6.900	Automatic drain valve



Filters

»FUTURA« series

MAX

Filters with excellent flow rates in modern design.

Input pressure	1.5 - 16 bar
Temperature range	-10 to 50 °C
Medium	Compressed air, neutral gases
Housing	PA66 GF60
Connecting thread	Material: Die-cast zinc
Sealant	NBR
Filter element	Cellpor (PE)
Filter rating	5 µm
Flow rate measurement	At P ₂ = 6 bar and pressure drop Δ _p = 1 bar

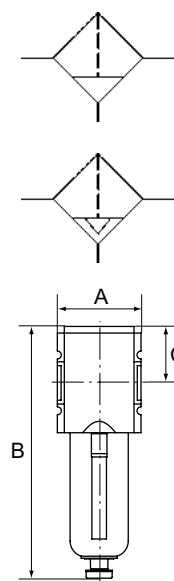

Filter with polycarbonate bowl and bowl guard

Art. No.	Type No.	Thread	Size	Flow rate l/min	Condensate drain	A mm	B mm	C mm
100145	FU 831	G 1/4	1	2200	Semi-automatic	52.0	164.0	34.0
100146	FU 832	G 3/8	1	2200	Semi-automatic	52.0	164.0	34.0
100147	FU 833	G 3/8	2	3500	Semi-automatic	63.0	189.5	42.5
100148	FU 834	G 1/2	2	3500	Semi-automatic	63.0	189.5	42.5
100149	FU 6130	G 3/4	4	8000	Semi-automatic	85.0	247.0	58.0
100150	FU 6131	G 1	4	8000	Semi-automatic	85.0	247.0	58.0
100151	FU 841	G 1/4	1	2200	Fully-automatic	52.0	179.0	34.0
100152	FU 842	G 3/8	1	2200	Fully-automatic	52.0	179.0	34.0
100153	FU 843	G 3/8	2	3500	Fully-automatic	63.0	205.5	42.5
100154	FU 844	G 1/2	2	3500	Fully-automatic	63.0	205.5	42.5
100155	FU 6140	G 3/4	4	8000	Fully-automatic	85.0	264.0	58.0
100156	FU 6141	G 1	4	8000	Fully-automatic	85.0	264.0	58.0



1



H 850

WK 100

Accessories / spare parts for filter G 1/4 and G 3/8 (Size 1)

Art. No.	Type No.	Description
100038	H 850	Mounting bracket, incl. 2 screws
100039	WK 100	Wall bracket, incl. 2 screws
100040	KP 100	Joiner set, incl. 2 screws
100130	BSF 14	Polycarbonate bowl, incl. bowl guard
100132	BSF 14-A	Polycarbonate bowl with automatic drain valve
135851	WK 101-14	Wall bracket with connection thread G 1/4
135852	WK 101-38	Wall bracket with connection thread G 3/8
100134	611.6.905	Filter element 5 µm, Cellpor
100362	655.6.900	Automatic drain valve



KP 100



BSF 14

Accessories / spare parts for filter G 3/8 and G 1/2 (Size 2)

Art. No.	Type No.	Description
100043	H 852	Mounting bracket, incl. 2 screws
100044	WK 102	Wall bracket, incl. 2 screws
100045	KP 200	Joiner set, incl. 2 screws
100135	BSF 12	Polycarbonate bowl, incl. bowl guard
100137	BSF 12-A	Polycarbonate bowl with automatic drain valve
100331	WK 102-38	Wall bracket with connection thread G 3/8
100332	WK 102-12	Wall bracket with connection thread G 1/2
100333	WK 102-34	Wall bracket with connection thread G 3/4
100139	844.6.905	Filter element 5 µm, cellpor
100362	655.6.900	Automatic drain valve



H 852



655.6.900



BSF 12



844.6.905

Accessories / spare parts for filter G 3/4 and G 1 (Size 4)

Art. No.	Type No.	Description
100048	H 854	Mounting bracket, incl. 2 screws
100049	WK 103	Wall bracket, incl. 2 screws
100050	KP 300	Joiner set, incl. 2 screws
100140	BSF 34	Polycarbonate bowl, incl. bowl guard
100142	BSF 34-A	Polycarbonate bowl with automatic drain valve
135853	WK 104-34	Wall bracket with connection thread G 3/4
135854	WK 104-1	Wall bracket with connection thread G 1
100144	6141.6.905	Filter element 5 µm, Cellpor
100362	655.6.900	Automatic drain valve



6141.6.905

Pre-filters

»FUTURA« series

MAX

Pre-filters in modern design for compliance with strict compressed air purity requirements. Pre-filters are used to separate solid impurities up to 0.3 µm from compressed air and gases.

Input pressure	1.5 - 16 bar
Temperature range	-10 to 50 °C
Medium	Compressed air, neutral gases
Housing	PA66 GF60
Connecting thread	Material: Die-cast zinc
Filter element	Impregnated paper
Filter rating	0.3 µm
Flow rate measurement	At P ₂ = 6 bar and pressure drop Δ _p = 0.02 bar

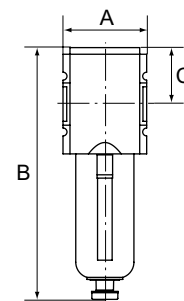
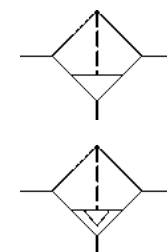

Pre-filter with polycarbonate bowl and bowl guard

Art. No.	Type No.	Thread	Size	Flow rate l/min	Condensate drain	A mm	B mm	C mm
100157	FU 851	G 1/4	1	300	Semi-automatic	52.0	169.5	39.5
100158	FU 852	G 3/8	1	300	Semi-automatic	52.0	169.5	39.5
100159	FU 853	G 3/8	2	500	Semi-automatic	63.0	194.8	47.8
100160	FU 854	G 1/2	2	500	Semi-automatic	63.0	194.8	47.8
100161	FU 6150	G 3/4	4	1500	Semi-automatic	85.0	252.0	63.0
100162	FU 6151	G 1	4	1500	Semi-automatic	85.0	252.0	63.0
100163	FU 861	G 1/4	1	300	Fully-automatic	52.0	184.5	39.5
100164	FU 862	G 3/8	1	300	Fully-automatic	52.0	184.5	39.5
100165	FU 863	G 3/8	2	500	Fully-automatic	63.0	210.8	47.8
100166	FU 864	G 1/2	2	500	Fully-automatic	63.0	210.8	47.8
100167	FU 6160	G 3/4	4	1500	Fully-automatic	85.0	269.0	63.0
100168	FU 6161	G 1	4	1500	Fully-automatic	85.0	269.0	63.0



FU 851

Accessories / spare parts for pre-filter G 1/4 and G 3/8 (Size 1)

Art. No.	Type No.	Description
100038	H 850	Mounting bracket, incl. 2 screws
100039	WK 100	Wall bracket, incl. 2 screws
100040	KP 100	Joiner set, incl. 2 screws
100130	BSF 14	Polycarbonate bowl, incl. bowl guard
100132	BSF 14-A	Polycarbonate bowl with automatic drain valve
100171	DAF 1	Differential pressure indicator
100172	DM 34	Differential pressure gauge
135851	WK 101-14	Wall bracket with connection thread G 1/4
135852	WK 101-38	Wall bracket with connection thread G 3/8
100169	V 23/40	Filter element (paper-POM) – automatic drain valve
100170	V 23/71	Filter element (paper-POM) – semi-automatic drain valve
100362	655.6.900	Automatic drain valve



H 850

WK 100



BSF 14

BSF 14-A

Accessories / spare parts for pre-filter G 3/8 and G 1/2 (Size 2)

Art. No.	Type No.	Description
100043	H 852	Mounting bracket, incl. 2 screws
100044	WK 102	Wall bracket, incl. 2 screws
100045	KP 200	Joiner set, incl. 2 screws
100135	BSF 12	Polycarbonate bowl, incl. bowl guard
100137	BSF 12-A	Polycarbonate bowl with automatic drain valve
100171	DAF 1	Differential pressure indicator
100172	DM 34	Differential pressure gauge
100331	WK 102-38	Wall bracket with connection thread G 3/8
100332	WK 102-12	Wall bracket with connection thread G 1/2
100333	WK 102-34	Wall bracket with connection thread G 3/4
100173	V 864/03	Filter element (paper-aluminium)
100362	655.6.900	Automatic drain valve



DAF 1

DM 34



WK 102-12

Accessories / spare parts for pre-filter G 3/4 and G 1 (Size 4)

Art. No.	Type No.	Description
100048	H 854	Mounting bracket, incl. 2 screws
100049	WK 103	Wall bracket, incl. 2 screws
100050	KP 300	Joiner set, incl. 2 screws
100140	BSF 34	Polycarbonate bowl, incl. bowl guard
100142	BSF 34-A	Polycarbonate bowl with automatic drain valve
100171	DAF 1	Differential pressure indicator
100172	DM 34	Differential pressure gauge
135853	WK 104-34	Wall bracket with connection thread G 3/4
135854	WK 104-1	Wall bracket with connection thread G 1
100174	V 864/04	Filter element (paper-aluminium)
100362	655.6.900	Automatic drain valve

Micro-filters (fine-filters)

»FUTURA« series

MAX

Micro-filters in modern design for compliance with strict compressed air purity requirements. Micro-filters are used to separate solid oil, water and solid impurities as small as 0.01 µm from compressed air and gases.

Input pressure	1.5 - 16 bar
Temperature range	-10 to 50 °C
Medium	Compressed air, neutral gases
Housing	PA66 GF60
Connecting thread	Material: Die-cast zinc
Filter element	Borosilicate glass fibre
Filter rating	0.01 µm
Residual oil content	< 0.01 mg/m ³
Dust separation	> 0.01 µm 99.999 %
Flow rate measurement	At P ₂ = 6 bar and pressure drop Δp = 0.1 bar

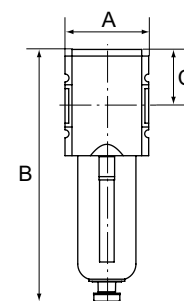
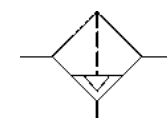
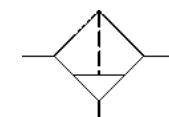

Micro-filter with polycarbonate bowl and bowl guard

Art. No.	Type No.	Thread	Size	Flow rate l/min	Condensate drain	A mm	B mm	C mm
100175	FU 871	G 1/4	1	350	Semi-automatic	52.0	169.5	39.5
100176	FU 872	G 3/8	1	350	Semi-automatic	52.0	169.5	39.5
100177	FU 873	G 3/8	2	450	Semi-automatic	63.0	194.8	47.8
100178	FU 874	G 1/2	2	450	Semi-automatic	63.0	194.8	47.8
100179	FU 6170	G 3/4	4	1500	Semi-automatic	85.0	252.0	63.0
100180	FU 6171	G 1	4	1500	Semi-automatic	85.0	252.0	63.0
100181	FU 881	G 1/4	1	350	Fully-automatic	52.0	184.5	39.5
100182	FU 882	G 3/8	1	350	Fully-automatic	52.0	184.5	39.5
100183	FU 883	G 3/8	2	450	Fully-automatic	63.0	210.8	47.8
100184	FU 884	G 1/2	2	450	Fully-automatic	63.0	210.8	47.8
100185	FU 6180	G 3/4	4	1500	Fully-automatic	85.0	269.0	63.0
100186	FU 6181	G 1	4	1500	Fully-automatic	85.0	269.0	63.0



FU 871

Accessories / spare parts for micro-filter G 1/4 and G 3/8 (Size 1)

Art. No.	Type No.	Description
100038	H 850	Mounting bracket, incl. 2 screws
100039	WK 100	Wall bracket, incl. 2 screws
100040	KP 100	Joiner set, incl. 2 screws
100130	BSF 14	Polycarbonate bowl, incl. bowl guard
100132	BSF 14-A	Polycarbonate bowl with automatic drain valve
100171	DAF 1	Differential pressure indicator
100172	DM 34	Differential pressure gauge
135851	WK 101-14	Wall bracket with connection thread G 1/4
135852	WK 101-38	Wall bracket with connection thread G 3/8
100187	M 23/70	Filter element (borosilicate-POM) – semi-autom. drain valve
100188	M 23/41	Filter element (borosilicate-POM) – automatic drain valve
100362	655.6.900	Automatic drain valve



H 850

WK 100



BSF 14

BSF 14-A

Accessories / spare parts for micro-filter G 3/8 and G 1/2 (Size 2)

Art. No.	Type No.	Description
100043	H 852	Mounting bracket, incl. 2 screws
100044	WK 102	Wall bracket, incl. 2 screws
100045	KP 200	Joiner set, incl. 2 screws
100135	BSF 12	Polycarbonate bowl, incl. bowl guard
100137	BSF 12-A	Polycarbonate bowl with automatic drain valve
100171	DAF 1	Differential pressure indicator
100172	DM 34	Differential pressure gauge
100331	WK 102-38	Wall bracket with connection thread G 3/8
100332	WK 102-12	Wall bracket with connection thread G 1/2



DAF 1

DM 34



WK 102-12

1



M 884/02

Accessories / spare parts for micro-filter G 3/8 and G 1/2 (Size 2)

Art. No.	Type No.	Description
100333	WK 102-34	Wall bracket with connection thread G 3/4
100189	M 884/01	Filter element (borosilicate-aluminium)
100362	655.6.900	Automatic drain valve

Accessories / spare parts for micro-filter G 3/4 and G 1 (Size 4)

Art. No.	Type No.	Description
100048	H 854	Mounting bracket, incl. 2 screws
100049	WK 103	Wall bracket, incl. 2 screws
100050	KP 300	Joiner set, incl. 2 screws
100140	BSF 34	Polycarbonate bowl, incl. bowl guard
100142	BSF 34-A	Polycarbonate bowl with automatic drain valve
100171	DAF 1	Differential pressure indicator
100172	DM 34	Differential pressure gauge
135853	WK 104-34	Wall bracket with connection thread G 3/4
135854	WK 104-1	Wall bracket with connection thread G 1
100190	M 884/02	Filter element (borosilicate-aluminium)
100362	655.6.900	Automatic drain valve



Activated carbon filters

»FUTURA« series

MAX

Activated carbon filters in modern design for compliance with strict compressed air purity requirements. Activated carbon filters are used to absorb oil vapour up to a residual oil content of 0.005 mg/m³ from compressed air and gases.

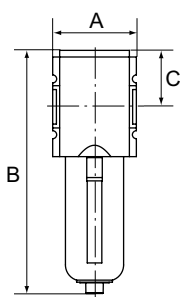

Input pressure	0 - 16 bar
Temperature range	-10 to 50 °C
Medium	Compressed air, neutral gases
Housing	PA66 GF60
Connecting thread	Material: Die-cast zinc
Filter element	Activated carbon
Residual oil content	0.005 mg/m ³
Flow rate measurement	At P ₂ = 6 bar and pressure drop Δ _p = 0.2 bar

Activated carbon filter with polycarbonate bowl and bowl guard

Art. No.	Type No.	Thread	Size	Flow rate l/min	A mm	B mm	C mm
100191	FU 891	G 1/4	1	470	52.0	157.0	34.0
100192	FU 892	G 3/8	1	470	52.0	157.0	34.0
100193	FU 893	G 3/8	2	1700	63.0	183.5	42.5
100194	FU 894	G 1/2	2	1700	63.0	183.5	42.5
100195	FU 6190	G 3/4	4	2500	85.0	242.0	58.0
100196	FU 6191	G 1	4	2500	85.0	242.0	58.0



FU 891

Accessories / spare parts for activated carbon filter G 1/4 and G 3/8 (Size 1)

Art. No.	Type No.	Description
100038	H 850	Mounting bracket, incl. 2 screws
100039	WK 100	Wall bracket, incl. 2 screws
100040	KP 100	Joiner set, incl. 2 screws
100197	BSA 14	Polycarbonate bowl, incl. bowl guard
135851	WK 101-14	Wall bracket with connection thread G 1/4
135852	WK 101-38	Wall bracket with connection thread G 3/8
100199	A 23/70	Filter element (activated carbon POM)



H 850

A 23/70

Accessories / spare parts for activated carbon filter G 3/8 and G 1/2 (Size 2)

Art. No.	Type No.	Description
100043	H 852	Mounting bracket, incl. 2 screws
100044	WK 102	Wall bracket, incl. 2 screws
100045	KP 200	Joiner set, incl. 2 screws
100200	BSA 12	Polycarbonate bowl, incl. bowl guard
100331	WK 102-38	Wall bracket with connection thread G 3/8
100332	WK 102-12	Wall bracket with connection thread G 1/2
100333	WK 102-34	Wall bracket with connection thread G 3/4
100202	A 894	Filter element (activated carbon)

**Accessories / spare parts for activated carbon filter G 3/4 and G 1 (Size 4)**

Art. No.	Type No.	Description
100048	H 854	Mounting bracket, incl. 2 screws
100049	WK 103	Wall bracket, incl. 2 screws
100050	KP 300	Joiner set, incl. 2 screws
100203	BSA 34	Polycarbonate bowl, incl. bowl guard
135853	WK 104-34	Wall bracket with connection thread G 3/4
135854	WK 104-1	Wall bracket with connection thread G 1
100205	A 896	Filter element (activated carbon)



A 896

Oil-mist lubricators

»FUTURA« series

MAX

Oil-mist lubricators with excellent flow rates in modern design. These devices can be used to top up oil automatically. A hose must be connected to the threaded nipple on the oil bowl for this purpose. When the oil filling button on the top of the device is pressed, a Venturi nozzle opens and sucks oil into the bowl under vacuum.

Max. input pressure	16 bar
Temperature range	-10 to 50 °C
Medium	Compressed air, neutral gases
Housing	PA66 GF60
Connecting thread	Material: Die-cast zinc
Sight dome	PC
Sealant	NBR
Oil grade	CL 32 acc. to DIN 51517-ISO VG 32
Flow rate measurement	At $P_2 = 6$ bar and pressure drop $\Delta p = 1$ bar

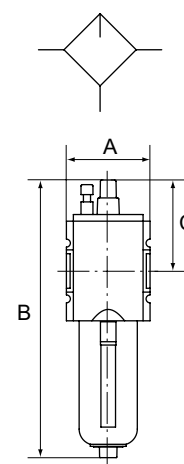
**Oil-mist lubricator with polycarbonate bowl and bowl guard**

Art. No.	Type No.	Thread	Size	Flow rate l/min	A mm	B mm	C mm
100206	FU 901	G 1/4	1	2750	52.0	186.0	64.0
100207	FU 902	G 3/8	1	2750	52.0	186.0	64.0
100208	FU 903	G 3/8	2	8000	63.0	210.0	70.0
100209	FU 904	G 1/2	2	8000	63.0	210.0	70.0
100210	FU 6201	G 3/4	4	14000	85.0	271.0	88.0
100211	FU 6202	G 1	4	14000	85.0	271.0	88.0



FU 901

→ We recommend our special pneumatic oil on page 145

Accessories / spare parts for oil-mist lubricator G 1/4 and G 3/8 (Size 1)

Art. No.	Type No.	Description
100038	H 850	Mounting bracket, incl. 2 screws
100039	WK 100	Wall bracket, incl. 2 screws
100040	KP 100	Joiner set, incl. 2 screws
100212	BSL 14	Polycarbonate bowl, incl. bowl guard for oiler
135851	WK 101-14	Wall bracket with connection thread G 1/4
135852	WK 101-38	Wall bracket with connection thread G 3/8
100214	901.7.990	Sight dome, polycarbonate



H 850

WK 100

1



Accessories / spare parts for oil-mist lubricator G 3/8 and G 1/2 (Size 2)

Art. No.	Type No.	Description
100043	H 852	Mounting bracket, incl. 2 screws
100044	WK 102	Wall bracket, incl. 2 screws
100045	KP 200	Joiner set, incl. 2 screws
100215	BSL 12	Polycarbonate bowl, incl. bowl guard for oiler
100331	WK 102-38	Wall bracket with connection thread G 3/8
100332	WK 102-12	Wall bracket with connection thread G 1/2
100333	WK 102-34	Wall bracket with connection thread G 3/4
100214	901.7.990	Sight dome, polycarbonate

Accessories / spare parts for oil-mist lubricator G 3/4 and G 1 (Size 4)

Art. No.	Type No.	Description
100048	H 854	Mounting bracket, incl. 2 screws
100049	WK 103	Wall bracket, incl. 2 screws
100050	KP 300	Joiner set, incl. 2 screws
100217	BSL 34	Polycarbonate bowl, incl. bowl guard for oiler
135853	WK 104-34	Wall bracket with connection thread G 3/4
135854	WK 104-1	Wall bracket with connection thread G 1
100214	901.7.990	Sight dome, polycarbonate

Service units

two-piece, »FUTURA« series

MAX

Two-piece service units with excellent flow rates in modern design. Lockable diaphragm pressure regulator with secondary ventilation, oil can be filled without interrupting operation.

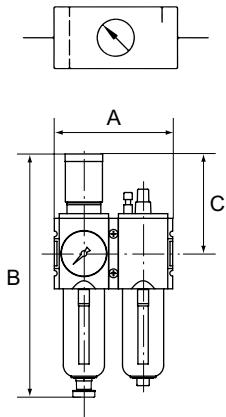

Input pressure	1.5 - 16 bar
Temperature range	-10 to 50 °C
Medium	Compressed air, neutral gases
Housing	PA66 GF60
Connecting thread	Material: Die-cast zinc
Filter element	Cellpor (PE)
Filter rating	5 µm
Sight dome	PC
Sealant	NBR
Diaphragms	NBR
Flow rate measurement	At P ₁ = 10 bar, P ₂ = 6.3 bar and pressure drop Δ _p = 1 bar



FU 601

Service unit, 2-piece with polycarbonate bowl, bowl guard and pressure gauge

Art. No.	Type No.	Thread	Size	Control range bar	Pressure gauge display bar	Flow rate l/min	Condensate drain	A mm	B mm	C mm
152346	FU 601-4	G 1/4	1	0,2 - 4	0 - 6	1750	Semi-automatic	104.0	226.0	96.0
100219	FU 601	G 1/4	1	0,5 - 8	0 - 10	1750	Semi-automatic	104.0	226.0	96.0
152347	FU 601-10	G 1/4	1	0,5 - 10	0 - 16	1750	Semi-automatic	104.0	226.0	96.0
152348	FU 601-16	G 1/4	1	0,5 - 16	0 - 25	1750	Semi-automatic	104.0	226.0	96.0
152351	FU 602-4	G 3/8	1	0,2 - 4	0 - 6	1750	Semi-automatic	104.0	226.0	96.0
100220	FU 602	G 3/8	1	0,5 - 8	0 - 10	1750	Semi-automatic	104.0	226.0	96.0
152352	FU 602-10	G 3/8	1	0,5 - 10	0 - 16	1750	Semi-automatic	104.0	226.0	96.0
152353	FU 602-16	G 3/8	1	0,5 - 16	0 - 25	1750	Semi-automatic	104.0	226.0	96.0
139548	FU 603-4	G 3/8	2	0,2 - 4	0 - 6	3500	Semi-automatic	126.0	257.0	110.0
100221	FU 603	G 3/8	2	0,5 - 8	0 - 10	3500	Semi-automatic	126.0	257.0	110.0

Service units

two-piece, »FUTURA« series

MAX

Service unit, 2-piece with polycarbonate bowl, bowl guard and pressure gauge

Art. No.	Type No.	Thread	Size	Control range bar	Pressure gauge display bar	Flow rate l/min	Condensate drain	A mm	B mm	C mm
139549	FU 603-10	G 3/8	2	0,5 - 10	0 - 16	3500	Semi-automatic	126.0	257.0	110.0
139550	FU 603-16	G 3/8	2	0,5 - 16	0 - 25	3500	Semi-automatic	126.0	257.0	110.0
139553	FU 604-4	G 1/2	2	0,2 - 4	0 - 6	3500	Semi-automatic	126.0	257.0	110.0
100222	FU 604	G 1/2	2	0,5 - 8	0 - 10	3500	Semi-automatic	126.0	257.0	110.0
139554	FU 604-10	G 1/2	2	0,5 - 10	0 - 16	3500	Semi-automatic	126.0	257.0	110.0
139555	FU 604-16	G 1/2	2	0,5 - 16	0 - 25	3500	Semi-automatic	126.0	257.0	110.0
152356	FU 605-4	G 3/4	4	0,2 - 4	0 - 6	12000	Semi-automatic	170.0	326.0	137.0
100223	FU 605	G 3/4	4	0,5 - 8	0 - 10	12000	Semi-automatic	170.0	326.0	137.0
152357	FU 605-10	G 3/4	4	0,5 - 10	0 - 16	12000	Semi-automatic	170.0	326.0	137.0
152358	FU 605-16	G 3/4	4	0,5 - 16	0 - 25	12000	Semi-automatic	170.0	326.0	137.0
152361	FU 606-4	G 1	4	0,2 - 4	0 - 6	12000	Semi-automatic	170.0	326.0	137.0
100224	FU 606	G 1	4	0,5 - 8	0 - 10	12000	Semi-automatic	170.0	326.0	137.0
152362	FU 606-10	G 1	4	0,5 - 10	0 - 16	12000	Semi-automatic	170.0	326.0	137.0
152363	FU 606-16	G 1	4	0,5 - 16	0 - 25	12000	Semi-automatic	170.0	326.0	137.0
152366	FU 611-4	G 1/4	1	0,2 - 4	0 - 6	1750	Fully-automatic	104.0	243.0	96.0
100225	FU 611	G 1/4	1	0,5 - 8	0 - 10	1750	Fully-automatic	104.0	243.0	96.0
152367	FU 611-10	G 1/4	1	0,5 - 10	0 - 16	1750	Fully-automatic	104.0	243.0	96.0
152368	FU 611-16	G 1/4	1	0,5 - 16	0 - 25	1750	Fully-automatic	104.0	243.0	96.0
152371	FU 612-4	G 3/8	1	0,2 - 4	0 - 6	1750	Fully-automatic	104.0	243.0	96.0
100226	FU 612	G 3/8	1	0,5 - 8	0 - 10	1750	Fully-automatic	104.0	243.0	96.0
152372	FU 612-10	G 3/8	1	0,5 - 10	0 - 16	1750	Fully-automatic	104.0	243.0	96.0
152373	FU 612-16	G 3/8	1	0,5 - 16	0 - 25	1750	Fully-automatic	104.0	243.0	96.0
152376	FU 613-4	G 3/8	2	0,2 - 4	0 - 6	3500	Fully-automatic	126.0	273.0	110.0
100227	FU 613	G 3/8	2	0,5 - 8	0 - 10	3500	Fully-automatic	126.0	273.0	110.0
152377	FU 613-10	G 3/8	2	0,5 - 10	0 - 16	3500	Fully-automatic	126.0	273.0	110.0
152378	FU 613-16	G 3/8	2	0,5 - 16	0 - 25	3500	Fully-automatic	126.0	273.0	110.0
152381	FU 614-4	G 1/2	2	0,2 - 4	0 - 6	3500	Fully-automatic	126.0	273.0	110.0
100228	FU 614	G 1/2	2	0,5 - 8	0 - 10	3500	Fully-automatic	126.0	273.0	110.0
152382	FU 614-10	G 1/2	2	0,5 - 10	0 - 16	3500	Fully-automatic	126.0	273.0	110.0
152383	FU 614-16	G 1/2	2	0,5 - 16	0 - 25	3500	Fully-automatic	126.0	273.0	110.0

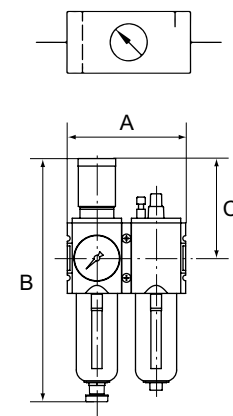

FU 611 + SS 32

- ➔ The price does not include a key lock. Please order separately.
- ➔ We recommend our special pneumatic oil on page 145
- ➔ Internal air consumption at size 4 (G 3/4 and G 1): max. 1.5 l/min (depending on secondary pressure)

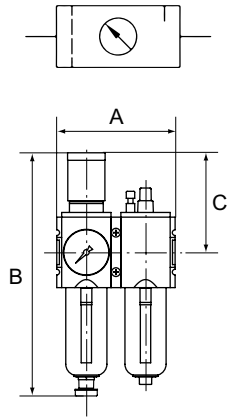

Service units

two-piece, »FUTURA« series

MAX

Service unit, 2-piece with polycarbonate bowl, bowl guard and pressure gauge

Art. No.	Type No.	Thread	Size	Control range bar	Pressure gauge display bar	Flow rate l/min	Condensate drain	A mm	B mm	C mm
152386	FU 615-4	G 3/4	4	0,2 - 4	0 - 6	12000	Fully-automatic	170.0	343.0	137.0
100229	FU 615	G 3/4	4	0,5 - 8	0 - 10	12000	Fully-automatic	170.0	343.0	137.0
152387	FU 615-10	G 3/4	4	0,5 - 10	0 - 16	12000	Fully-automatic	170.0	343.0	137.0
152388	FU 615-16	G 3/4	4	0,5 - 16	0 - 25	12000	Fully-automatic	170.0	343.0	137.0
152391	FU 616-4	G 1	4	0,2 - 4	0 - 6	12000	Fully-automatic	170.0	343.0	137.0
100230	FU 616	G 1	4	0,5 - 8	0 - 10	12000	Fully-automatic	170.0	343.0	137.0
152392	FU 616-10	G 1	4	0,5 - 10	0 - 16	12000	Fully-automatic	170.0	343.0	137.0
152393	FU 616-16	G 1	4	0,5 - 16	0 - 25	12000	Fully-automatic	170.0	343.0	137.0

- ➔ The price does not include a key lock. Please order separately.
- ➔ We recommend our special pneumatic oil on page 145
- ➔ Internal air consumption at size 4 (G 3/4 and G 1): max. 1.5 l/min (depending on secondary pressure)



Accessories / spare parts for service unit G 1/4 and G 3/8 (Size 1)

Art. No.	Type No.	Description
100038	H 850	Mounting bracket, incl. 2 screws
100039	WK 100	Wall bracket, incl. 2 screws
100040	KP 100	Joiner set, incl. 2 screws
100130	BSF 14	Polycarbonate bowl, incl. bowl guard
100212	BSL 14	Polycarbonate bowl, incl. bowl guard for oiler
100132	BSF 14-A	Polycarbonate bowl with automatic drain valve
100041	FU 11-55	Panel nut M36x1.5
100037	SS 32	Key lock
135851	WK 101-14	Wall bracket with connection thread G 1/4
135852	WK 101-38	Wall bracket with connection thread G 3/8
152945	H 851	Mounting bracket with control panel nut M36x1.5
100134	611.6.905	Filter element 5 µm, Cellpor
100214	901.7.990	Sight dome, polycarbonate
100042	22.7010.4	Seal kit for pressure regulator
100362	655.6.900	Automatic drain valve

Accessories / spare parts for service unit G 3/8 and G 1/2 (Size 2)

Art. No.	Type No.	Description
100043	H 852	Mounting bracket, incl. 2 screws
100044	WK 102	Wall bracket, incl. 2 screws
100045	KP 200	Joiner set, incl. 2 screws
100135	BSF 12	Polycarbonate bowl, incl. bowl guard
100215	BSL 12	Polycarbonate bowl, incl. bowl guard for oiler
100137	BSF 12-A	Polycarbonate bowl with automatic drain valve
100046	FU 33-55	Panel nut M42x1.5
100037	SS 32	Key lock
100331	WK 102-38	Wall bracket with connection thread G 3/8
100332	WK 102-12	Wall bracket with connection thread G 1/2
100333	WK 102-34	Wall bracket with connection thread G 3/4
152946	H 853	Mounting bracket with control panel nut M42x1.5
100139	844.6.905	Filter element 5 µm, cellpor
100214	901.7.990	Sight dome, polycarbonate

Accessories / spare parts for service unit G 3/8 and G 1/2 (Size 2)

Art. No.	Type No.	Description
100047	22.7180.4	Seal kit for pressure regulator
100362	655.6.900	Automatic drain valve

**Accessories / spare parts for service unit G 3/4 and G 1 (Size 4)**

Art. No.	Type No.	Description
100048	H 854	Mounting bracket, incl. 2 screws
100049	WK 103	Wall bracket, incl. 2 screws
100050	KP 300	Joiner set, incl. 2 screws
100140	BSF 34	Polycarbonate bowl, incl. bowl guard
100217	BSL 34	Polycarbonate bowl, incl. bowl guard for oiler
100142	BSF 34-A	Polycarbonate bowl with automatic drain valve
100037	SS 32	Key lock
135853	WK 104-34	Wall bracket with connection thread G 3/4
135854	WK 104-1	Wall bracket with connection thread G 1
100144	6141.6.905	Filter element 5 µm, Cellpor
100214	901.7.990	Sight dome, polycarbonate
100051	22.71110.4	Seal kit for pressure regulator
100362	655.6.900	Automatic drain valve



Service units

three-piece, »FUTURA« series

MAX

Three-piece service units with excellent flow rates in modern design. Lockable diaphragm pressure regulator with secondary ventilation, oil can be filled without interrupting operation.

Input pressure	1.5 - 16 bar
Temperature range	-10 to 50 °C
Medium	Compressed air, neutral gases
Housing	PA66 GF60
Connecting thread	Material: Die-cast zinc
Filter element	Cellpor (PE)
Filter rating	5 µm
Sight dome	PC
Sealant	NBR
Diaphragms	NBR
Flow rate measurement	At $P_1 = 10$ bar, $P_2 = 6.3$ bar and pressure drop $\Delta p = 1$ bar

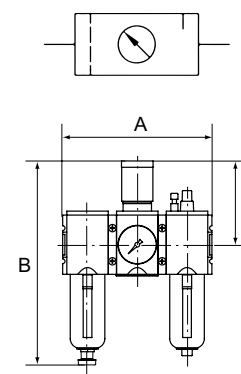

FU 621

Service unit, 3-piece with polycarbonate bowl, bowl guard and pressure gauge

Art. No.	Type No.	Thread	Size	Control range bar	Pressure gauge display bar	Flow rate l/min	Condensate drain	A mm	B mm	C mm
152615	FU 621-4	G 1/4	1	0,2 - 4	0 - 6	1750	Semi-automatic	156.0	226.0	96.0
100231	FU 621	G 1/4	1	0,5 - 8	0 - 10	1750	Semi-automatic	156.0	226.0	96.0
152616	FU 621-10	G 1/4	1	0,5 - 10	0 - 16	1750	Semi-automatic	156.0	226.0	96.0
152617	FU 621-16	G 1/4	1	0,5 - 16	0 - 25	1750	Semi-automatic	156.0	226.0	96.0
152620	FU 622-4	G 3/8	1	0,2 - 4	0 - 6	1750	Semi-automatic	156.0	226.0	96.0
100232	FU 622	G 3/8	1	0,5 - 8	0 - 10	1750	Semi-automatic	156.0	226.0	96.0
152621	FU 622-10	G 3/8	1	0,5 - 10	0 - 16	1750	Semi-automatic	156.0	226.0	96.0
152622	FU 622-16	G 3/8	1	0,5 - 16	0 - 25	1750	Semi-automatic	156.0	226.0	96.0
139570	FU 623-4	G 3/8	2	0,2 - 4	0 - 6	3500	Semi-automatic	189.0	257.0	110.0
100233	FU 623	G 3/8	2	0,5 - 8	0 - 10	3500	Semi-automatic	189.0	257.0	110.0

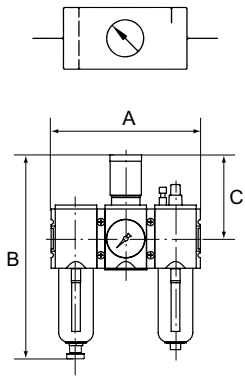

Service units

three-piece, »FUTURA« series

MAX

Service unit, 3-piece with polycarbonate bowl, bowl guard and pressure gauge

Art. No.	Type No.	Thread	Size	Control range bar	Pressure gauge display bar	Flow rate l/min	Condensate drain	A mm	B mm	C mm
139571	FU 623-10	G 3/8	2	0,5 - 10	0 - 16	3500	Semi-automatic	189.0	257.0	110.0
139572	FU 623-16	G 3/8	2	0,5 - 16	0 - 25	3500	Semi-automatic	189.0	257.0	110.0
139575	FU 624-4	G 1/2	2	0,2 - 4	0 - 6	3500	Semi-automatic	189.0	257.0	110.0
100234	FU 624	G 1/2	2	0,5 - 8	0 - 10	3500	Semi-automatic	189.0	257.0	110.0
139576	FU 624-10	G 1/2	2	0,5 - 10	0 - 16	3500	Semi-automatic	189.0	257.0	110.0
139577	FU 624-16	G 1/2	2	0,5 - 16	0 - 25	3500	Semi-automatic	189.0	257.0	110.0
152625	FU 625-4	G 3/4	4	0,2 - 4	0 - 6	12000	Semi-automatic	225.0	326.0	137.0
100235	FU 625	G 3/4	4	0,5 - 8	0 - 10	12000	Semi-automatic	255.0	326.0	137.0
152626	FU 625-10	G 3/4	4	0,5 - 10	0 - 16	12000	Semi-automatic	225.0	326.0	137.0
152627	FU 625-16	G 3/4	4	0,5 - 16	0 - 25	12000	Semi-automatic	225.0	326.0	137.0
152630	FU 626-4	G 1	4	0,2 - 4	0 - 6	12000	Semi-automatic	225.0	326.0	137.0
100236	FU 626	G 1	4	0,5 - 8	0 - 10	12000	Semi-automatic	255.0	326.0	137.0
152631	FU 626-10	G 1	4	0,5 - 10	0 - 16	12000	Semi-automatic	225.0	326.0	137.0
152632	FU 626-16	G 1	4	0,5 - 16	0 - 25	12000	Semi-automatic	225.0	326.0	137.0
152635	FU 633-4	G 1/4	1	0,2 - 4	0 - 6	1750	Fully-automatic	156.0	243.0	96.0
100237	FU 633	G 1/4	1	0,5 - 8	0 - 10	1750	Fully-automatic	156.0	243.0	96.0
152636	FU 633-10	G 1/4	1	0,5 - 10	0 - 16	1750	Fully-automatic	156.0	243.0	96.0
152637	FU 633-16	G 1/4	1	0,5 - 16	0 - 25	1750	Fully-automatic	156.0	243.0	96.0
152640	FU 634-4	G 3/8	1	0,2 - 4	0 - 6	1750	Fully-automatic	156.0	243.0	96.0
100238	FU 634	G 3/8	1	0,5 - 8	0 - 10	1750	Fully-automatic	156.0	243.0	96.0
152641	FU 634-10	G 3/8	1	0,5 - 10	0 - 16	1750	Fully-automatic	156.0	243.0	96.0
152642	FU 634-16	G 3/8	1	0,5 - 16	0 - 25	1750	Fully-automatic	156.0	243.0	96.0
152645	FU 635-4	G 3/8	2	0,2 - 4	0 - 6	3500	Fully-automatic	189.0	273.0	110.0
100239	FU 635	G 3/8	2	0,5 - 8	0 - 10	3500	Fully-automatic	189.0	273.0	110.0
152646	FU 635-10	G 3/8	2	0,5 - 10	0 - 16	3500	Fully-automatic	189.0	273.0	110.0
152647	FU 635-16	G 3/8	2	0,5 - 16	0 - 25	3500	Fully-automatic	189.0	273.0	110.0
152650	FU 636-4	G 1/2	2	0,2 - 4	0 - 6	3500	Fully-automatic	189.0	273.0	110.0
100240	FU 636	G 1/2	2	0,5 - 8	0 - 10	3500	Fully-automatic	189.0	273.0	110.0
152651	FU 636-10	G 1/2	2	0,5 - 10	0 - 16	3500	Fully-automatic	189.0	273.0	110.0
152652	FU 636-16	G 1/2	2	0,5 - 16	0 - 25	3500	Fully-automatic	189.0	273.0	110.0



FU 633 + SS 32

Service units

three-piece, »FUTURA« series

MAX

Service unit, 3-piece with polycarbonate bowl, bowl guard and pressure gauge

Art. No.	Type No.	Thread	Size	Control range bar	Pressure gauge display bar	Flow rate l/min	Condensate drain	A mm	B mm	C mm
152655	FU 637-4	G 3/4	4	0,2 - 4	0 - 6	12000	Fully-automatic	255.0	343.0	137.0
100241	FU 637	G 3/4	4	0,5 - 8	0 - 10	12000	Fully-automatic	255.0	343.0	137.0
152656	FU 637-10	G 3/4	4	0,5 - 10	0 - 16	12000	Fully-automatic	255.0	343.0	137.0
152657	FU 637-16	G 3/4	4	0,5 - 16	0 - 25	12000	Fully-automatic	255.0	343.0	137.0
152660	FU 638-4	G 1	4	0,2 - 4	0 - 6	12000	Fully-automatic	255.0	343.0	137.0
100242	FU 638	G 1	4	0,5 - 8	0 - 10	12000	Fully-automatic	255.0	343.0	137.0
152661	FU 638-10	G 1	4	0,5 - 10	0 - 16	12000	Fully-automatic	255.0	343.0	137.0
152662	FU 638-16	G 1	4	0,5 - 16	0 - 25	12000	Fully-automatic	255.0	343.0	137.0

- The price does not include a key lock. Please order separately.
- We recommend our special pneumatic oil on page 145
- Internal air consumption at size 4 (G 3/4 and G 1): max. 1.5 l/min (depending on secondary pressure)

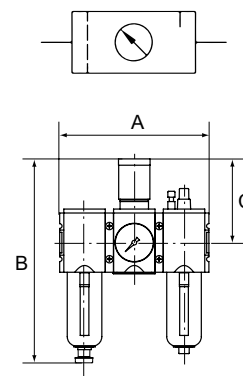

Accessories / spare parts for service unit G 1/4 and G 3/8 (Size 1)

Art. No.	Type No.	Description
100038	H 850	Mounting bracket, incl. 2 screws
100039	WK 100	Wall bracket, incl. 2 screws
100040	KP 100	Joiner set, incl. 2 screws
100130	BSF 14	Polycarbonate bowl, incl. bowl guard
100212	BSL 14	Polycarbonate bowl, incl. bowl guard for oiler
100132	BSF 14-A	Polycarbonate bowl with automatic drain valve
100037	SS 32	Key lock
135851	WK 101-14	Wall bracket with connection thread G 1/4
135852	WK 101-38	Wall bracket with connection thread G 3/8
152945	H 851	Mounting bracket with control panel nut M36x1.5
100134	611.6.905	Filter element 5 µm, Cellpor
100214	901.7.990	Sight dome, polycarbonate
100042	22.7010.4	Seal kit for pressure regulator
100362	655.6.900	Automatic drain valve



Accessories / spare parts for service unit G 3/8 and G 1/2 (Size 2)

Art. No.	Type No.	Description
100043	H 852	Mounting bracket, incl. 2 screws
100044	WK 102	Wall bracket, incl. 2 screws
100045	KP 200	Joiner set, incl. 2 screws
100135	BSF 12	Polycarbonate bowl, incl. bowl guard
100215	BSL 12	Polycarbonate bowl, incl. bowl guard for oiler
100137	BSF 12-A	Polycarbonate bowl with automatic drain valve
100046	FU 33-55	Panel nut M42x1.5
100037	SS 32	Key lock
100331	WK 102-38	Wall bracket with connection thread G 3/8
100332	WK 102-12	Wall bracket with connection thread G 1/2
100333	WK 102-34	Wall bracket with connection thread G 3/4
152946	H 853	Mounting bracket with control panel nut M42x1.5
100139	844.6.905	Filter element 5 µm, cellpor
100214	901.7.990	Sight dome, polycarbonate



1



6141.6.905 22.7180.4



22.71110.4

Accessories / spare parts for service unit G 3/8 and G 1/2 (Size 2)

Art. No.	Type No.	Description
100047	22.7180.4	Seal kit for pressure regulator
100362	655.6.900	Automatic drain valve

Accessories / spare parts for service unit G 3/4 and G 1 (Size 4)

Art. No.	Type No.	Description
100048	H 854	Mounting bracket, incl. 2 screws
100049	WK 103	Wall bracket, incl. 2 screws
100050	KP 300	Joiner set, incl. 2 screws
100140	BSF 34	Polycarbonate bowl, incl. bowl guard
100217	BSL 34	Polycarbonate bowl, incl. bowl guard for oiler
100142	BSF 34-A	Polycarbonate bowl with automatic drain valve
100037	SS 32	Key lock
135853	WK 104-34	Wall bracket with connection thread G 3/4
135854	WK 104-1	Wall bracket with connection thread G 1
100144	6141.6.905	Filter element 5 µm, Cellpor
100214	901.7.990	Sight dome, polycarbonate
100051	22.71110.4	Seal kit for pressure regulator
100362	655.6.900	Automatic drain valve

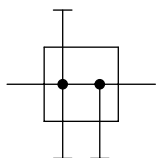

Manifolds

»FUTURA« series

MAX

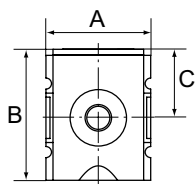

Max. input pressure	16 bar
Temperature range	-10 to 50 °C
Medium	Compressed air, neutral gases
Housing	PA66 GF60
Connecting thread	Material: Die-cast zinc



FU 941

Manifold

Art. No.	Type No.	Thread	Size	Outlet	Flow rate l/min	A mm	B mm	C mm
100274	FU 941	G 1/4	1	3 x G 1/4	2700	52.0	65.5	34.5
100275	FU 942	G 3/8	1	3 x G 1/4	3600	52.0	65.5	34.5
100276	FU 943	G 3/8	2	2 x G 3/8, 1 x G 1/4, 1 x G 1/2	7250	63.0	80.5	43.0
100277	FU 944	G 1/2	2	2 x G 3/8, 1 x G 1/4, 1 x G 1/2	7250	63.0	80.5	43.0
100278	FU 945	G 3/4	4	2 x G 3/4	18000	85.0	109.5	58.5
100279	FU 946	G 1	4	2 x G 3/4	18000	85.0	109.5	58.5



H 850

WK 100



22.DS9410.4

1920.11P4

Accessories / spare parts for manifold G 1/4 and G 3/8 (Size 1)

Art. No.	Type No.	Description
100038	H 850	Mounting bracket, incl. 2 screws
100039	WK 100	Wall bracket, incl. 2 screws
100040	KP 100	Joiner set, incl. 2 screws
100280	DS 9410	Pressure switches - suitable for flange mounting
135851	WK 101-14	Wall bracket with connection thread G 1/4
135852	WK 101-38	Wall bracket with connection thread G 3/8
100281	22.DS9410.4	Moulded seal for flanged pressure switch
100282	1920.11P4	Coupling socket for pressure switch



H 852

DS 9410

Accessories / spare parts for manifold G 3/8 and G 1/2 (Size 2)

Art. No.	Type No.	Description
100043	H 852	Mounting bracket, incl. 2 screws
100044	WK 102	Wall bracket, incl. 2 screws
100045	KP 200	Joiner set, incl. 2 screws
100280	DS 9410	Pressure switches - suitable for flange mounting
100331	WK 102-38	Wall bracket with connection thread G 3/8

Accessories / spare parts for manifold G 3/8 and G 1/2 (Size 2)

Art. No.	Type No.	Description
100332	WK 102-12	Wall bracket with connection thread G 1/2
100333	WK 102-34	Wall bracket with connection thread G 3/4
100281	22.DS9410.4	Moulded seal for flanged pressure switch
100282	1920.11P4	Coupling socket for pressure switch



WK 102-12

Accessories / spare parts for manifold G 3/4 and G 1 (Size 4)

Art. No.	Type No.	Description
100048	H 854	Mounting bracket, incl. 2 screws
100049	WK 103	Wall bracket, incl. 2 screws
100050	KP 300	Joiner set, incl. 2 screws
100280	DS 9410	Pressure switches - suitable for flange mounting
135853	WK 104-34	Wall bracket with connection thread G 3/4
135854	WK 104-1	Wall bracket with connection thread G 1
100281	22.DS9410.4	Moulded seal for flanged pressure switch
100282	1920.11P4	Coupling socket for pressure switch



Manifolds with pressure switch

»FUTURA« series

MAX

Max. input pressure	16 bar
Temperature range	-10 to 50 °C
Medium	Compressed air, neutral gases
Housing	PA66 GF60
Connecting thread	Material: Die-cast zinc
Flow rate	7250 l/min

Manifold with pressure switch

Art. No.	Type No.	Thread	Size	Outlet	Adjustment range bar	A mm	B mm	C mm
139305	FU 943-DS10	G 3/8	2	2 x G 3/8, 1 x G 1/2	0.5 - 10	63.0	150.5	113.0
139306	FU 944-DS10	G 1/2	2	2 x G 3/8, 1 x G 1/2	0.5 - 10	63.0	150.5	113.0

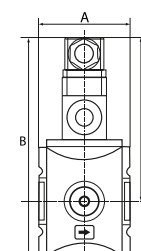
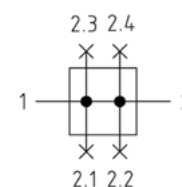

FU 944-DS10

Accessories / spare parts

Art. No.	Type No.	Description
100043	H 852	Mounting bracket, incl. 2 screws
100044	WK 102	Wall bracket, incl. 2 screws
100045	KP 200	Joiner set, incl. 2 screws
100280	DS 9410	Pressure switches - suitable for flange mounting
100331	WK 102-38	Wall bracket with connection thread G 3/8
100332	WK 102-12	Wall bracket with connection thread G 1/2
100333	WK 102-34	Wall bracket with connection thread G 3/4
100281	22.DS9410.4	Moulded seal for flanged pressure switch
100282	1920.11P4	Coupling socket for pressure switch



KP 200

DS 9410

1

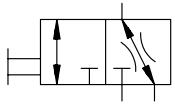

Ball valves (3/2-way)

»FUTURA« series

MAX

Lockable ball valve, 3/2-way type including silencer, mechanically operated.

Rotary switch can be turned 90°, with indication of positions:

Horizontal: Input closed - outlet exhausted

Vertical: Flow open - exhaust closed

Exhaust air can be collected.

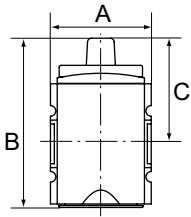

FU 951



FU 951 + VS 37

Max. input pressure	16 bar
Temperature range	-10 to 50 °C
Medium	Compressed air, neutral gases
Housing	PA66 GF60
Connecting thread	Material: Die-cast zinc
Flow rate measurement	At $P_2 = 6$ bar and pressure drop $\Delta p = 1$ bar

Ball valve (3/2-way)

Art. No.	Type No.	Thread	Size	Exhaust air	Flow rate l/min	A mm	B mm	C mm
100283	FU 951	G 1/4	1	G 1/4	1900	52.0	87.5	54.5
100284	FU 952	G 3/8	1	G 1/4	1900	52.0	87.5	54.5
100285	FU 981	G 3/8	2	G 1/2	14000	63.0	127.0	70.5
100286	FU 982	G 1/2	2	G 1/2	14000	63.0	127.0	70.5
100287	FU 983	G 3/4	4	G 3/4	25000	85.0	144.7	93.7
100288	FU 984	G 1	4	G 3/4	25000	85.0	144.7	93.7

→ The price does not include a padlock. Please order separately.



H 850



564-2



567-2/M



VS 37

Accessories for ball valve G 1/4 and G 3/8 (Size 1)

Art. No.	Type No.	Description
100038	H 850	Mounting bracket, incl. 2 screws
100039	WK 100	Wall bracket, incl. 2 screws
100040	KP 100	Joiner set, incl. 2 screws
100289	564-2	Silencer, sintered bronze, short
100290	567-2/M	Silencer, sintered bronze, with brass hexagon nut and thread
100273	VS 37	Padlock, band \varnothing 6 mm
135851	WK 101-14	Wall bracket with connection thread G 1/4
135852	WK 101-38	Wall bracket with connection thread G 3/8

Accessories for ball valve G 3/8 and G 1/2 (Size 2)

Art. No.	Type No.	Description
100043	H 852	Mounting bracket, incl. 2 screws
100044	WK 102	Wall bracket, incl. 2 screws
100045	KP 200	Joiner set, incl. 2 screws
100291	564-4	Silencer, sintered bronze, short
100292	567-4/M	Silencer, sintered bronze, with brass hexagon nut and thread
100273	VS 37	Padlock, band \varnothing 6 mm
100331	WK 102-38	Wall bracket with connection thread G 3/8
100332	WK 102-12	Wall bracket with connection thread G 1/2
100333	WK 102-34	Wall bracket with connection thread G 3/4

Accessories for ball valve G 3/4 and G 1 (Size 4)

Art. No.	Type No.	Description
100048	H 854	Mounting bracket, incl. 2 screws
100049	WK 103	Wall bracket, incl. 2 screws
100050	KP 300	Joiner set, incl. 2 screws
100293	567-5/M	Silencer, sintered bronze, with brass hexagon nut and thread
100273	VS 37	Padlock, band \varnothing 6 mm
135853	WK 104-34	Wall bracket with connection thread G 3/4
135854	WK 104-1	Wall bracket with connection thread G 1



WK 102-12



H 852



WK 102



KP 200

3/2-way valves, electrically operated

»FUTURA« series

MAX

Pneumatic systems or parts of systems can be switched on and off by means of an electrical signal.
3/2-way type including silencer.
When they are switched off, the system is exhausted at the same time.

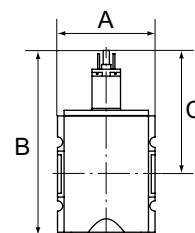
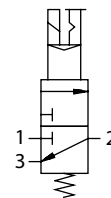

Input pressure	2 - 10 bar
Temperature range	-10 to 50 °C
Medium	Compressed air, neutral gases
Duty cycle	100 %
Pick-up power with 50 Hz AC voltage	2.2 VA
Holding power with 50 Hz AC voltage	1.6 VA
Power input	2.5 Watt with DC voltage
Protection IP	IP 65
Electrical connection	Socket coupling EN 175301-803, form C, poles 2+PE
Housing	PA66 GF60
Connecting thread	G 1/4 (NPTF option)
Flow rate measurement	At P ₂ = 6 bar and pressure drop Δ _p = 1 bar

3/2-way valve, electrically operated, with 24 V DC, 2.5 W solenoid

Art. No.	Type No.	Thread	Size	Exhaust air	Flow rate l/min	A mm	B mm	C mm
100294	FU 923	G 1/4	1	G 1/4	2000	52.0	117.8	84.8
100295	FU 924	G 3/8	1	G 1/4	2000	52.0	117.8	84.8
100296	FU 963	G 3/8	2	G 1/2	4500	63.0	150.3	93.8
100297	FU 964	G 1/2	2	G 1/2	4500	63.0	150.3	93.8
100298	FU 975	G 3/4	4	G 1/2	12500	85.0	177.7	110.7
100299	FU 976	G 1	4	G 1/2	12500	85.0	177.7	110.7



FU 923

3/2-way valve, electrically operated, with 230 V AC, 50 Hz solenoid

Art. No.	Type No.	Thread	Size	Exhaust air	Flow rate l/min	A mm	B mm	C mm
100300	FU 927	G 1/4	1	G 1/4	2000	52.0	117.8	84.8
100301	FU 928	G 3/8	1	G 1/4	2000	52.0	117.8	84.8
100302	FU 967	G 3/8	2	G 1/2	4500	63.0	150.3	93.8
100303	FU 968	G 1/2	2	G 1/2	4500	63.0	150.3	93.8
100304	FU 979	G 3/4	4	G 1/2	12500	85.0	177.7	110.7
100305	FU 980	G 1	4	G 1/2	12500	85.0	177.7	110.7

Accessories / spare parts for 3/2-way valve G 1/4 and G 3/8 (Size 1)

Art. No.	Type No.	Description
100038	H 850	Mounting bracket, incl. 2 screws
100039	WK 100	Wall bracket, incl. 2 screws
100040	KP 100	Joiner set, incl. 2 screws
100289	564-2	Silencer, sintered bronze, short
100290	567-2/M	Silencer, sintered bronze, with brass hexagon nut and thread
135851	WK 101-14	Wall bracket with connection thread G 1/4
135852	WK 101-38	Wall bracket with connection thread G 3/8
100306	400-900-42	Pilot valve 24 V DC
100308	400-900-17	Pilot valve 230 V AC
100310	1920.FU	Connector type C



567-2/M

WK 102-12



400-900-42

400-900-17



1920.FU

Accessories / spare parts for 3/2-way valve G 3/8 and G 1/2 (Size 2)

Art. No.	Type No.	Description
100043	H 852	Mounting bracket, incl. 2 screws
100044	WK 102	Wall bracket, incl. 2 screws
100045	KP 200	Joiner set, incl. 2 screws
100291	564-4	Silencer, sintered bronze, short

Accessories / spare parts for 3/2-way valve G 3/8 and G 1/2 (Size 2)

Art. No.	Type No.	Description
100292	567-4/M	Silencer, sintered bronze, with brass hexagon nut and thread
100331	WK 102-38	Wall bracket with connection thread G 3/8
100332	WK 102-12	Wall bracket with connection thread G 1/2
100333	WK 102-34	Wall bracket with connection thread G 3/4
100306	400-900-42	Pilot valve 24 V DC
100308	400-900-17	Pilot valve 230 V AC
100310	1920.FU	Connector type C

Accessories / spare parts for 3/2-way valve G 3/4 and G 1 (Size 4)

Art. No.	Type No.	Description
100048	H 854	Mounting bracket, incl. 2 screws
100049	WK 103	Wall bracket, incl. 2 screws
100050	KP 300	Joiner set, incl. 2 screws
100293	567-5/M	Silencer, sintered bronze, with brass hexagon nut and thread
135853	WK 104-34	Wall bracket with connection thread G 3/4
135854	WK 104-1	Wall bracket with connection thread G 1
100306	400-900-42	Pilot valve 24 V DC
100308	400-900-17	Pilot valve 230 V AC
100310	1920.FU	Connector type C

3/2-way valves, pneumatically operated

»FUTURA« series

MAX

Pneumatic systems or parts of systems can be switched on and off by means of an pneumatic signal. 3/2-way type including silencer. When they are switched off, the system is exhausted at the same time.

Max. input pressure	16 bar
Temperature range	-10 to 50 °C
Medium	Compressed air, neutral gases
Housing	PA66 GF60
Connecting thread	Material: Die-cast zinc
Flow rate measurement	At P ₂ = 6 bar and pressure drop Δp = 1 bar

3/2-way valve, pneumatically operated

Art. No.	Type No.	Thread	Size	Exhaust air	Flow rate l/min	A mm	B mm	C mm
156616	FU 927-137	G 1/4	1	G 1/4	2000	52.0	85.1	52.1
156617	FU 928-137	G 3/8	1	G 1/4	2000	52.0	85.1	52.1
139309	FU 967-137	G 3/8	2	G 1/2	4500	63.0	117.6	61.1
139310	FU 968-137	G 1/2	2	G 1/2	4500	63.0	117.6	61.1
156618	FU 979-137	G 3/4	4	G 1/2	12500	85.0	145.0	78.0
156619	FU 980-137	G 1	4	G 1/2	12500	85.0	145.0	78.0

Accessories / spare parts for 3/2-way valve G 1/4 and G 3/8 (Size 1)

Art. No.	Type No.	Description
100038	H 850	Mounting bracket, incl. 2 screws
100039	WK 100	Wall bracket, incl. 2 screws
100040	KP 100	Joiner set, incl. 2 screws
100289	564-2	Silencer, sintered bronze, short
100290	567-2/M	Silencer, sintered bronze, with brass hexagon nut and thread
135851	WK 101-14	Wall bracket with connection thread G 1/4
135852	WK 101-38	Wall bracket with connection thread G 3/8

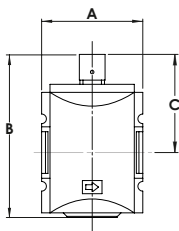
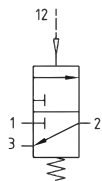

FU 927-137



FU 968-137



H 850

WK 100

Accessories / spare parts for 3/2-way valve G 3/8 and G 1/2 (Size 2)

Art. No.	Type No.	Description
100043	H 852	Mounting bracket, incl. 2 screws
100044	WK 102	Wall bracket, incl. 2 screws
100045	KP 200	Joiner set, incl. 2 screws
100291	564-4	Silencer, sintered bronze, short
100292	567-4/M	Silencer, sintered bronze, with brass hexagon nut and thread
100331	WK 102-38	Wall bracket with connection thread G 3/8
100332	WK 102-12	Wall bracket with connection thread G 1/2
100333	WK 102-34	Wall bracket with connection thread G 3/4

**Accessories / spare parts for 3/2-way valve G 3/4 and G 1 (Size 4)**

Art. No.	Type No.	Description
100048	H 854	Mounting bracket, incl. 2 screws
100049	WK 103	Wall bracket, incl. 2 screws
100050	KP 300	Joiner set, incl. 2 screws
100293	567-5/M	Silencer, sintered bronze, with brass hexagon nut and thread
135853	WK 104-34	Wall bracket with connection thread G 3/4
135854	WK 104-1	Wall bracket with connection thread G 1



Filling valves (start-up valves)

»FUTURA« series

MAX

Seat valves operated by secondary pressure for controlled pressurisation of pneumatic systems. These valves prevent a sudden build-up of pressure accompanied by dangerous, jerky cylinder movements. The full cross-section of the regulator is opened at 50% of the input pressure. The filling time can be altered by turning the adjusting screw.

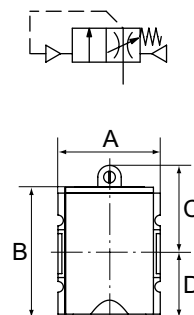

Input pressure	2.5 - 16 bar
Temperature range	-10 to 50 °C
Medium	Compressed air, neutral gases
Housing	PA66 GF60
Connecting thread	Material: Die-cast zinc
Flow rate measurement	At $P_2 = 6$ bar and pressure drop $\Delta p = 1$ bar

Filling valve (start-up valve)

Art. No.	Type No.	Thread	Size	Flow rate l/min	A mm	B mm	C mm	D mm
100311	FU 931	G 1/4	1	2000	52.0	78.0	45.0	33.0
100312	FU 932	G 3/8	1	2000	52.0	78.0	45.0	33.0
100313	FU 933	G 3/8	2	4500	63.0	111.5	53.5	58.0
100314	FU 934	G 1/2	2	4500	63.0	111.5	53.5	58.0
100315	FU 935	G 3/4	4	10000	85.0	112.0	58.0	54.0
100316	FU 936	G 1	4	10000	85.0	112.0	58.0	54.0



FU 931

→ More technical data see 3/2-way valve and filling unit

Accessories for filling valve G 1/4 and G 3/8 (Size 1)

Art. No.	Type No.	Description
100038	H 850	Mounting bracket, incl. 2 screws
100039	WK 100	Wall bracket, incl. 2 screws
100040	KP 100	Joiner set, incl. 2 screws
135851	WK 101-14	Wall bracket with connection thread G 1/4
135852	WK 101-38	Wall bracket with connection thread G 3/8



Accessories for filling valve G 3/8 and G 1/2 (Size 2)

Art. No.	Type No.	Description
100043	H 852	Mounting bracket, incl. 2 screws
100044	WK 102	Wall bracket, incl. 2 screws
100045	KP 200	Joiner set, incl. 2 screws
100331	WK 102-38	Wall bracket with connection thread G 3/8
100332	WK 102-12	Wall bracket with connection thread G 1/2
100333	WK 102-34	Wall bracket with connection thread G 3/4

Accessories for filling valve G 3/4 and G 1 (Size 4)

Art. No.	Type No.	Description
100048	H 854	Mounting bracket, incl. 2 screws
100049	WK 103	Wall bracket, incl. 2 screws
100050	KP 300	Joiner set, incl. 2 screws
135853	WK 104-34	Wall bracket with connection thread G 3/4
135854	WK 104-1	Wall bracket with connection thread G 1

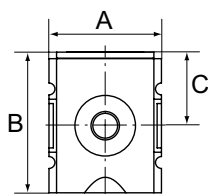
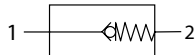
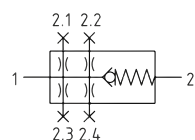
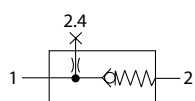

FU 9401



FU 9404



H 850

WK 100

Non-return valves

»FUTURA« series

MAX

Input pressure	0.4 - 16 bar
Temperature range	-10 to 50 °C
Medium	Compressed air, neutral gases
Housing	PA66 GF60
Sealant	NBR
Connecting thread	Material: Die-cast zinc
Flow rate measurement	At P ₂ = 6 bar and pressure drop Δ _p = 1 bar

Non-return valve

Art. No.	Type No.	Thread	Size	Flow rate l/min	A mm	B mm	C mm
156654	FU 9401	G 1/4	1	1250	52.0	66.8	34.0
156655	FU 9402	G 3/8	1	1250	52.0	66.8	34.0
139311	FU 9403	G 3/8	2	4500	63.0	80.5	43.0
139312	FU 9404	G 1/2	2	4500	63.0	80.5	43.0
156656	FU 9405	G 3/4	4	16000	85.0	112.2	58.2
156657	FU 9406	G 1	4	16000	85.0	112.2	58.2

Accessories / spare parts for non-return valve G 1/4 and G 3/8 (Size 1)

Art. No.	Type No.	Description
100038	H 850	Mounting bracket, incl. 2 screws
100039	WK 100	Wall bracket, incl. 2 screws
100040	KP 100	Joiner set, incl. 2 screws
135851	WK 101-14	Wall bracket with connection thread G 1/4
135852	WK 101-38	Wall bracket with connection thread G 3/8

Accessories / spare parts for non-return valve G 3/8 and G 1/2 (Size 2)

Art. No.	Type No.	Description
100043	H 852	Mounting bracket, incl. 2 screws
100044	WK 102	Wall bracket, incl. 2 screws
100045	KP 200	Joiner set, incl. 2 screws
100331	WK 102-38	Wall bracket with connection thread G 3/8
100332	WK 102-12	Wall bracket with connection thread G 1/2
100333	WK 102-34	Wall bracket with connection thread G 3/4

Accessories / spare parts for non-return valve G 3/4 and G 1 (Size 4)

Art. No.	Type No.	Description
100048	H 854	Mounting bracket, incl. 2 screws
100049	WK 103	Wall bracket, incl. 2 screws
100050	KP 300	Joiner set, incl. 2 screws
135853	WK 104-34	Wall bracket with connection thread G 3/4
135854	WK 104-1	Wall bracket with connection thread G 1



Differential pressure flow meter

»FUTURA« series

MAX

Differential pressure measuring system for detecting changes in flow rate or consumption and measuring energy efficiency. There is a differential pressure at the sensor as soon as a fluid starts to flow. Fast and accurate measurements can be achieved in this way. This robust instrument in a modern design offers a high level of safety (codable) and requires no maintenance.

Accessories:

Wall bracket or alternative a mounting bracket for wall mounting as a component of the »FUTURA« service unit.

Wall brackets with a connection thread for mounting to an existing compressed air system.

Joiner set for easy adaptation as a component of the »FUTURA« service unit.

Adapter plates for adapting different »FUTURA« service unit sizes.

Measuring system	Differential pressure method
Medium	Compressed air, neutral gases
Operating pressure	0 - 16 bar
Temperature range	0 to 50 °C
Flow rate output	Analog 0 to 10 V
Operating voltage	24 V DC
Display	Background lighting



KDDM-250

Differential pressure flow meter, Size 2

Art. No.	Type No.	Measuring range l/min
100329	KDDM-220	150 - 2000
100330	KDDM-250	200 - 5000

➔ Differential pressure flow meter with analog output 4 to 20 mA available on request



Mounting
wall bracket

Accessories for differential pressure flow meter

Art. No.	Type No.	Description
100044	WK 102	Wall bracket, incl. 2 screws
100331	WK 102-38	Wall bracket with connection thread G 3/8
100332	WK 102-12	Wall bracket with connection thread G 1/2
100333	WK 102-34	Wall bracket with connection thread G 3/4
100043	H 852	Mounting bracket, incl. 2 screws
100045	KP 200	Joiner set, incl. 2 screws
100334	AP 21	Adapter plate from size 2 on size 1
100335	AP 24	Adapter plate from size 2 on size 4
135865	SNT-230/24	Wall power supply 100-240 V AC / 24 V DC, 5-pole, M12x1



WK 102

WK 102-12



H 852

SNT-230/24

Analysis package for differential pressure flow meter

incl. data converter with USB interface for PC

MAX II

Software package incl. data converter for logging and analysing measured values. Graphical recording, evaluation and documentation of the flow rate, total consumption and switching states of the digital outputs. Easy integration of charts via the USB interface to your PC (minimum system requirement: Windows XP).



DDM-2

Analysis package for differential pressure flow meter

Art. No.	Type No.	Description
100336	DDM-2	Evaluation software for PC, incl. data converter

Fully-automatic drain valve

For all size G 1/4 or larger filters, filter regulators, service units and combined units.
Not suitable for our »Mini« Series nor for the »multifix« Series.
Easier to mount than the standard manual drain valve.

Operating pressure	4 - 16 bar
Operating temperature	0 to 90 °C
DN	4
Bonnet	Brass
Housing	Plastic (PA)
Medium	Condensate (emulsion)
Tank connection	G 1/8 male
Drain-side thread	G 1/4 female
Mounting position	Bowl mounted – vertical ± 10%

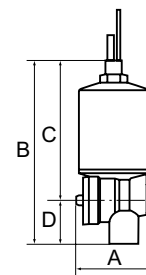

65/0-N

Fully-automatic drain valve incl. adapter G 1/8 i. x M14x1

Art. No.	Type No.	A mm	B mm	C mm	D mm
100677	65/0-N	46.5	109.0	83.0	26.0

Special pneumatic oil

For oil-mist lubricators, pneumatic tools and pneumatic systems.

Heavy-duty lubricating oil for hydraulic and pneumatic systems, type HVLP
acc. to DIN 51524, Part 3. Mineral oil based for high functional and operating reliability.

The high viscosity index of 190 permits several viscosity classes to be covered with one oil quality,
so that smooth running is guaranteed even at very low temperatures.

Good corrosion protection, excellent resistance to ageing and special wear protection assure optimal working.

The oil contains no zinc compounds.

Temperature range	-35 to 85 °C
-------------------	--------------

Special pneumatic oil

Art. No.	Type No.	Description
101135	32	2.5 litre canister



32

1

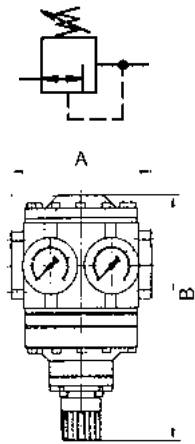

Large pressure regulators

Diaphragm pressure regulators, independent of inlet pressure, with internal pilot control and self-relieving design.
 Separate indication of input and working pressure on two pressure gauges.
 The pressure setting can be locked by pushing the button down.

Max. input pressure	40 bar
Max. medium temperature	60 °C
Max. ambient temperature	90 °C
DN	50
Housing	Aluminium
Sealant	NBR
Flow rate	48000 l/min
Flow rate measurement	At $P_1 = 10$ bar, $P_2 = 8$ bar and pressure drop $\Delta_p = 1$ bar



637.75

Pressure regulator with 2 pressure gauges for input and output pressure

Art. No.	Type No.	Thread	Control range bar	A mm	B mm
101136	637.75	G 1 1/2	0,5 - 6	180.0	246.0
101137	637.76	G 1 1/2	0,5 - 10	180.0	246.0
101138	637.77	G 1 1/2	0,5 - 16	180.0	246.0
101139	637.78	G 1 1/2	0,5 - 25	180.0	246.0
101140	637.85	G 2	0,5 - 6	160.0	246.0
101141	637.86	G 2	0,5 - 10	160.0	246.0
101142	637.87	G 2	0,5 - 16	160.0	246.0
101143	637.88	G 2	0,5 - 25	160.0	246.0

→ We recommend always using these controllers in conjunction with our filters for high pressures up to 40 bar, see on page 147-148



H 805



22.686.4

Accessories / spare parts

Art. No.	Type No.	Description
101144	H 805	Mounting bracket with 4 screws
101146	22.686.4	Set of wearing parts

High-pressure regulators up to 60 bar



Reversible piston-type pressure regulator, virtually independent of inlet pressure, with self-relieving design, manufactured entirely in brass. Specially designed for high pressures up to 60 bar. Pressure catch with counter nut.

Max. input pressure	60 bar
Operating temperature	-10 to 90 °C
Housing	Brass
Sealant	NBR
Applications	Compressed air and other neutral, non-flammable gases
Flow rate measurement	At $P_1 = 20$ bar, $P_2 = 10$ bar and pressure drop $\Delta p = 4$ bar

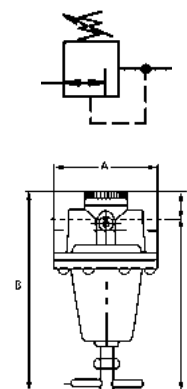

High-pressure regulator up to 60 bar, incl. pressure gauge

Art. No.	Type No.	Thread	Control range bar	Flow rate l/min	A mm	B mm	C mm	D mm
101147	637.901	G 3/8	0,5 - 12	2500	72.0	164.0	31.0	133.0
101148	637.902	G 3/8	1 - 20	2500	72.0	164.0	31.0	133.0
101149	637.903	G 3/8	2 - 35	2500	72.0	164.0	31.0	133.0
101150	637.904	G 3/8	2 - 50	2500	72.0	164.0	31.0	133.0
101151	637.911	G 1	0,5 - 12	5000	118.0	257.0	51.0	206.0
101152	637.912	G 1	1 - 20	5000	118.0	257.0	51.0	206.0
101153	637.913	G 1	2 - 35	5000	118.0	257.0	51.0	206.0
101154	637.914	G 1	3 - 50	5000	118.0	257.0	51.0	206.0



637.901



637.914



280-115



302-6

Accessories / spare parts for high-pressure regulator G 3/8

Art. No.	Type No.	Description
101155	484.302	Mounting bracket with nut and washer
101156	274-49	Switchboard attachment
101157	280-115	Cone seal complete

Accessories / spare parts for high-pressure regulator G 1

Art. No.	Type No.	Description
101158	302-19	Bracket mounting
101159	302-6	Cone seal complete

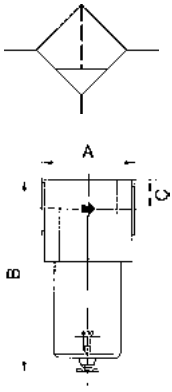

Filters

for high pressures up to 40 bar



Centrifugal separators with a sintered filter element.

Max. input pressure	40 bar
Max. medium temperature	60 °C
Max. ambient temperature	90 °C
Housing	Aluminium
Condensate drain	Manual drain valve
Filter rating	40 µm
Flow rate measurement	At P ₂ = 6 bar and pressure drop Δp = 1 bar



680.26

Filter for high pressures up to 40 bar with manual drain valve

Art. No.	Type No.	Thread	Bowl	Flow rate l/min	A mm	B mm	C mm
101160	680.21	G 3/8	Brass	2650	73.0	194.0	32.5
101161	680.22	G 1/2	Brass	2650	65.0	194.0	32.5
101162	680.23	G 3/4	Brass	3350	92.0	205.0	40.0
101163	680.24	G 1	Brass	3350	80.0	205.0	40.0
101164	680.26	G 1 1/2	Aluminium	20000	160.0	284.0	42.5
101165	680.27	G 2	Aluminium	20000	140.0	284.0	42.5

→ Heavy-duty pressure regulators at page 159



ZW 68-1

811.6.950

Accessories / spare parts for filter G 3/8 and G 1/2

Art. No.	Type No.	Description
101166	ZW 68-1	Mounting bracket with 2 screws
101167	680/12	Metal bowl (filter)
101121	811.6.950	Filter insert 40 µm, sintered bronze



680/13

655.6.950

Accessories / spare parts for filter G 3/4 and G 1

Art. No.	Type No.	Description
101169	680/13	Metal bowl (filter)
101168	655.6.950	Filter insert 40 µm, sintered bronze



429/27

687.6.050

Accessories / spare parts for filter G 1 1/2 and G 2

Art. No.	Type No.	Description
101170	429/27	Mounting bracket with 2 screws for G 1 to G 2
101172	680/15	Metal bowl (filter)
101171	687.6.050	Filter element 40 µm, sintered bronze

Filters

for high pressures up to 60 bar



Centrifugal separator with a sintered filter element.

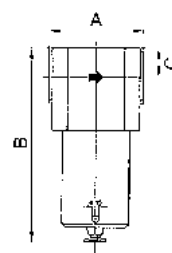
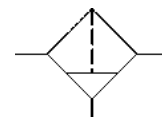

Max. input pressure	60 bar
Operating temperature	0 to 90 °C
Housing	Aluminium
Bowl	Brass
Sealant	NBR
Condensate drain	Manual drain valve
Filter rating	40 µm
Flow rate measurement	At P ₂ = 6 bar and pressure drop Δ _p = 0.5 bar

Filter for high pressures up to 60 bar with manual drain valve

Art. No.	Type No.	Thread	Flow rate l/min	A mm	B mm	C mm
101174	680.31	G 3/8	2660	73.0	187.0	25.0
101175	680.32	G 1/2	2660	65.0	187.0	25.0
101176	680.33	G 3/4	6000	92.0	196.0	29.0
101177	680.34	G 1	6000	80.0	196.0	29.0



680.31

Accessories / spare parts for filter G 3/8 and G 1/2

Art. No.	Type No.	Description
101166	ZW 68-1	Mounting bracket with 2 screws
101121	811.6.950	Filter insert 40 µm, sintered bronze
101178	811.6.905	Filter insert 5 µm, sintered bronze



ZW 68-1



811.6.950

Spare parts for filter G 3/4 and G 1

Art. No.	Type No.	Description
101168	655.6.950	Filter insert 40 µm, sintered bronze
101179	655.6.905	Filter insert 5 µm, cellpor



811.6.905



655.6.950



655.6.905

1

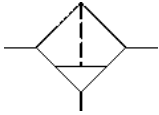

Micro-filters

for high pressures up to 60 bar



Fine filter for all applications with particularly strict compressed air purity requirements. Micro-filters should always be used in conjunction with a standard filter connected upstream to trap coarse impurities and protect the micro-filter inserts.

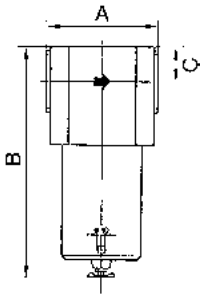

Max. input pressure	60 bar
Operating temperature	0 to 90 °C
Housing	Aluminium
Bowl	Brass
Sealant	NBR
Filter element	Borosilicate
Filter rating	0.01 µm
Efficiency	99.9999 %
Flow rate measurement	At $P_2 = 6$ bar and pressure drop $\Delta p = 0.5$ bar



680.44

Micro-filter for high pressures up to 60 bar

Art. No.	Type No.	Thread	Flow rate l/min	A mm	B mm	C mm
101180	680.41	G 3/8	2000	73.0	187.0	25.0
101181	680.42	G 1/2	2000	65.0	187.0	25.0
101182	680.43	G 3/4	2300	92.0	196.0	29.0
101183	680.44	G 1	2300	80.0	196.0	29.0



ZW 68-1

Accessories / spare parts for micro-filter G 3/8 and G 1/2

Art. No.	Type No.	Description
101166	ZW 68-1	Mounting bracket with 2 screws
101184	361/1	Filter element, borosilicate, microfibre non-woven material



360/3

Spare part for micro-filter G 3/4 and G 1

Art. No.	Type No.	Description
101008	360/3	Filter element, borosilicate-aluminium

Pressure regulators with pneumatic remote control

»Standard« series

EASY

Diaphragm pressure regulators, self-relieving, with pneumatic remote control. The full functionality is assured in combination with a pilot regulator. We recommend using one of our precision or standard pressure regulators with a G 1/4 port as the pilot regulator. The output pressure corresponds to the set pressure of the pilot pressure regulator.

To design a closed control loop similar to the sketch below please use our precision pilot regulator (feedback).

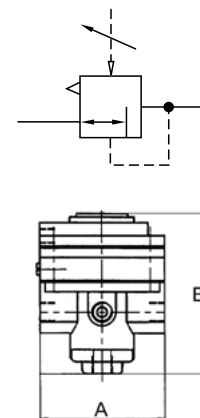

Port for pneumatic remote control	G 1/4
Max. medium temperature	80 °C
Max. operating temperature	80 °C
Sealant	NBR
Flow rate measurement	At $P_1 = 8 \text{ bar}$, $P_2 = 6 \text{ bar}$ and pressure drop $\Delta p = 1 \text{ bar}$

Pressure regulator with pneumatic remote control, without pressure gauge

Art. No.	Type No.	Thread	Max. input pressure bar	Housing	Flow rate l/min	A mm	B mm
101252	637.301	G 1/2	25	Die-cast zinc	5800	82.0	74.0
101253	637.302	G 3/4	40	Aluminium	15000	125.0	109.0
101254	637.303	G 1	40	Aluminium	15000	125.0	109.0
101255	637.304	G 1 1/4	40	Aluminium	31500	125.0	123.0
101256	637.305	G 1 1/2	40	Aluminium	31500	125.0	123.0
101257	637.306	G 2	25	Aluminium	50000	160.0	198.0



637.306

Accessories

Art. No.	Type No.	Description
101233	H 84	Mounting bracket to G 1/2
100845	H 86	Mounting bracket



H 84

H 86

1

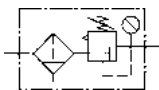

Precision filter regulators



Diaphragm pressure regulators containing no non-ferrous metals, with secondary venting, combined with a centrifugal separator for applications requiring an extremely accurate working pressure.

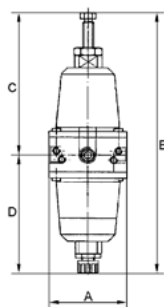

Max. input pressure	16 bar
Max. medium temperature	60 °C
Max. ambient temperature	60 °C
Medium	Micro-filtered, unoiled compressed air (0.01 µm)
Housing	Die-cast zinc
Sealant	NBR
Gauge port size	G 1/4
Filter rating	10 µm
Max. internal air consumption	0.2 l/min, depending on input pressure and control range
Flow rate	750 l/min



778.85

Precision filter regulator without pressure gauge, no non-ferrous metals

Art. No.	Type No.	Thread	Control range bar	A mm	B mm	C mm	D mm
101217	778.82	G 1/4	0,1 - 2	60.0	216.0	120.0	96.0
101218	778.83	G 1/4	0,1 - 3	60.0	216.0	120.0	96.0
101219	778.85	G 1/4	0,2 - 5	60.0	216.0	120.0	96.0



Accessories / spare parts

Art. No.	Type No.	Description
101220	H 820	Mounting bracket with screws
101222	214-KD	Pressure gauge Ø 63 mm, G 1/4 ET, 0 - 2.5 bar/36 psi
101223	215-KD	Pressure gauge Ø 63 mm, G 1/4 ET, 0 - 4 bar/58 psi
101224	216-KD	Pressure gauge Ø 63 mm, G 1/4 ET, 0 - 6 bar/87 psi
101221	22.662.4	Set of wearing parts

Precision pressure regulators



Diaphragm pressure regulators containing no non-ferrous metals, with secondary venting for applications requiring an extremely accurate working pressure.

Max. input pressure	16 bar
Max. medium temperature	60 °C
Max. ambient temperature	60 °C
Medium	Micro-filtered, unoiled compressed air (0.01 µm)
Housing	Die-cast zinc
Sealant	NBR
Gauge port size	G 1/4
Max. internal air consumption	0.2 l/min, depending on input pressure and control range
Flow rate	750 l/min

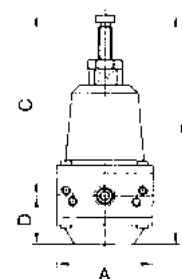
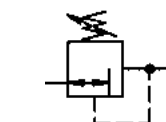

Precision pressure regulator without pressure gauge, no non-ferrous metals

Art. No.	Type No.	Thread	Control range bar	A mm	B mm	C mm	D mm
101225	637.62	G 1/4	0,1 - 2	60.0	152.0	120.0	32.0
101226	637.63	G 1/4	0,1 - 3	60.0	152.0	120.0	32.0
101227	637.64	G 1/4	0,2 - 5	60.0	152.0	120.0	32.0



637.62

Accessories / spare parts

Art. No.	Type No.	Description
101220	H 820	Mounting bracket with screws
100534	FM 33 K-HA	Micro-filters with polycarbonate bowl
101222	214-KD	Pressure gauge Ø 63 mm, G 1/4 ET, 0 - 2.5 bar/36 psi
101223	215-KD	Pressure gauge Ø 63 mm, G 1/4 ET, 0 - 4 bar/58 psi
101224	216-KD	Pressure gauge Ø 63 mm, G 1/4 ET, 0 - 6 bar/87 psi
101221	22.662.4	Set of wearing parts



216-KD



FM 33 K-HA

1

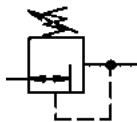

Precision pressure regulators

without air consumption



Diaphragm pressure regulators with secondary venting for applications requiring an accurate working pressure.

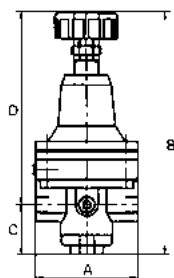

Max. input pressure	16 bar
Max. medium temperature	60 °C
Max. ambient temperature	60 °C
Medium	Fine-filtered (5 µm), unlubricated compr. air, neutral gases
Housing	Die-cast zinc
Sealant	NBR
Valve cone	FPM
Diaphragms	FPM
Gauge port size	G 1/4



637.73

Precision pressure regulator without internal air consumption, without pressure gauge

Art. No.	Type No.	Thread	Control range bar	Flow rate l/min	A mm	B mm	C mm	D mm
101229	637.71	G 1/4	0,1 - 1	740	82.0	148.0	19.5	128.5
101230	637.72	G 1/4	0,1 - 3	740	82.0	148.0	19.5	128.5
101231	637.73	G 1/4	0,2 - 6	540	82.0	148.0	19.5	128.5
101232	637.74	G 1/4	0,5 - 10	500	82.0	148.0	19.5	128.5



H 84

Accessories

Art. No.	Type No.	Description
101233	H 84	Mounting bracket to G 1/2

Precision pressure regulators



With high flow rate and large secondary venting.

Diaphragm pressure regulators with large secondary venting for applications requiring an extremely accurate working pressure, especially at high flow rates.

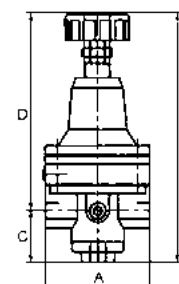
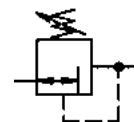

Max. input pressure	16 bar
Max. medium temperature	60 °C
Max. ambient temperature	60 °C
Medium	Micro-filtered, unoiled compressed air (0.01 µm)
Housing	Die-cast zinc
Sealant	NBR
Gauge port size	G 1/4
Vent port	G 3/8 (for mounting a silencer)
Max. internal air consumption	1.5 - 6 l/min, depending on input pressure and control range

Precision pressure regulator without pressure gauge

Art. No.	Type No.	Thread	Control range bar	Flow rate l/min	A mm	B mm	C mm	D mm
101234	637.31	G 1/4	0,05 - 3	700	82.0	202.5	43.5	159.0
101235	637.33	G 1/4	0,05 - 7	1500	82.0	202.5	43.5	159.0
101236	637.41	G 3/8	0,05 - 3	3000	82.0	202.5	43.5	159.0
101237	637.43	G 3/8	0,05 - 7	5500	82.0	202.5	43.5	159.0
101238	637.51	G 1/2	0,05 - 3	3000	82.0	202.5	43.5	159.0
101239	637.52	G 1/2	0,05 - 5	4500	82.0	202.5	43.5	159.0
101240	637.53	G 1/2	0,05 - 7	5500	82.0	202.5	43.5	159.0



637.52

→ A set of wearing parts cannot be supplied!
 These pressure regulators are only allowed to be opened in the factory!

Accessories

Art. No.	Type No.	Description
100840	H 822	Mounting bracket with screws
101242	566-3	Silencer
100534	FM 33 K-HA	Micro-filters with polycarbonate bowl
101223	215-KD	Pressure gauge Ø 63 mm, G 1/4 ET, 0 - 4 bar/58 psi
101224	216-KD	Pressure gauge Ø 63 mm, G 1/4 ET, 0 - 6 bar/87 psi
101244	217-KD	Pressure gauge Ø 63 mm, G 1/4 ET, 0 - 10 bar/145 psi



H 822



566-3



FM 33 K-HA



215-KD



217-KD

1

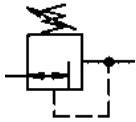

Precision pressure regulators



Diaphragm pressure regulators with secondary venting for applications requiring an extremely accurate working pressure.

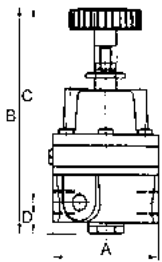

Max. input pressure	16 bar
Max. medium temperature	60 °C
Max. ambient temperature	60 °C
Medium	Micro-filtered, unoiled compressed air (0.01 µm)
Housing	Die-cast zinc
Sealant	NBR
Gauge port size	G 1/8
Max. internal air consumption	2.2 - 4.5 l/min, depend. on input pressure and control range



637.92

Precision pressure regulator without pressure gauge

Art. No.	Type No.	Thread	Control range bar	Flow rate l/min	A mm	B mm	C mm	D mm
101245	637.92	G 1/4	0,05 - 2	450	58.0	124.0	107.0	17.0
101246	637.93	G 1/4	0,05 - 4	570	58.0	124.0	107.0	17.0
101247	637.94	G 1/4	0,05 - 7	850	58.0	124.0	107.0	17.0

→ A set of wearing parts cannot be supplied!
These pressure regulators are only allowed to be opened in the factory!

Accessories

Art. No.	Type No.	Description
101248	638.00	Mounting bracket
100533	FM 11 K-HA	Micro-filters with polycarbonate bowl
101222	214-KD	Pressure gauge Ø 63 mm, G 1/4 ET, 0 - 2.5 bar/36 psi
101224	216-KD	Pressure gauge Ø 63 mm, G 1/4 ET, 0 - 6 bar/87 psi
101244	217-KD	Pressure gauge Ø 63 mm, G 1/4 ET, 0 - 10 bar/145 psi
101249	257.22	Nipple for pressure gauge



638.00



FM 11 K-HA



216-KD



217-KD



257.22

Precision pressure regulators



Diaphragm pressure regulators with large secondary venting and low internal air consumption.

Max. input pressure	12 bar
Control range	0,05 - 8 bar
Max. medium temperature	60 °C
Max. ambient temperature	60 °C
Medium	Micro-filtered, unoiled compressed air (0.01 µm)
Housing	Aluminium
Sealant	NBR
Gauge port size	G 1/8
Vent port	G 1/4
Max. internal air consumption	< 0.5 l/min at P ₁ = 8 bar
Flow rate	1250 l/min
Flow rate measurement	At P ₁ = 8 bar, P ₂ = 6 bar and pressure drop Δ _p = 1 bar

Precision pressure regulator without pressure gauge

Art. No.	Type No.	Thread	A mm	B mm	C mm	D mm
135884	637.97	G 1/4	50.0	145.0	35.0	110.0

→ A set of wearing parts cannot be supplied!
These pressure regulators are only allowed to be opened in the factory!

Accessories

Art. No.	Type No.	Description
100344	MV 30	Mounting bracket with nut M30x1.5
101672	110.46-KD	Standard pressure gauge

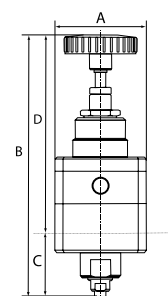
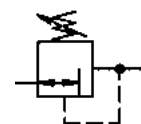

637.97



MV 30

110.46-KD

Precision pilot regulators (feedback)



Diaphragm pressure regulator for feedback systems, specially designed for use in a pneumatically controlled closed control loop in combination with a pressure regulator with pneumatic remote control.

Max. input pressure	16 bar
Max. medium temperature	80 °C
Max. ambient temperature	80 °C
Control range	0,2 - 7 bar
Housing	Die-cast zinc
Sealant	FPM
Diaphragms	FPM
Gauge port size	For feedback pressure
Max. internal air consumption	3 - 6 l/min

Precision pilot regulator without pressure gauge

Art. No.	Type No.	Thread	A mm	B mm	C mm	D mm
101250	637.310	G 1/4	82.0	142.8	19.4	123.4

Accessories

Art. No.	Type No.	Description
101233	H 84	Mounting bracket to G 1/2
101251	74/8	Control panel nut M20x1.5

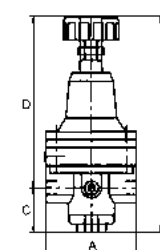
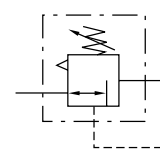

637.310

1

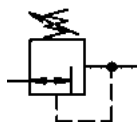

Precision pressure regulators

pneumatic remote control by means of an external pilot control valve



With high flow rate and large secondary venting.

Pneumatically controlled diaphragm pressure regulators with large secondary venting for applications requiring an extremely accurate working pressure, especially at high flow rates. We recommend our »multifix« series of pilot controllers.

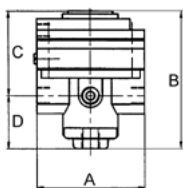

637.603

Max. input pressure	16 bar
Max. pilot pressure	10 bar
Control range	0,05 - 7 bar
Max. medium temperature	60 °C
Max. ambient temperature	60 °C
Medium	Micro-filtered, unoiled compressed air (0.01 µm)
Housing	Die-cast zinc, painted black
Sealant	NBR
Gauge port size	G 1/4
Vent port	G 3/8 (for mounting a silencer)
Control air port	G 1/8
Max. internal air consumption	6 l/min (depending on secondary pressure)
Flow rate	3000 l/min
Flow rate measurement	At $P_1 = 5 \text{ bar}$, $P_2 = 3 \text{ bar}$ and pressure drop $\Delta p \leq 0,1 \text{ bar}$

Precision pressure regulator, pneumatic remote control by means of external pilot control valve, without pressure gauge

Art. No.	Type No.	Thread	A mm	B mm	C mm	D mm
101258	637.603	G 1/2	82.0	108.0	64.5	43.5

→ A set of wearing parts cannot be supplied!
These pressure regulators are only allowed to be opened in the factory!

Accessories

Art. No.	Type No.	Description
100840	H 822	Mounting bracket with screws
101242	566-3	Silencer
100534	FM 33 K-HA	Micro-filters with polycarbonate bowl
101244	217-KD	Pressure gauge Ø 63 mm, G 1/4 ET, 0 - 10 bar/145 psi



H 822



566-3



FM 33 K-HA



217-KD

Heavy-duty pressure regulators



Diaphragm pressure regulators, independent of inlet pressure, with internal pilot control and self-relieving design for very high flow rates.

Separate indication of input and working pressure on two pressure gauges.

The pressure setting can be locked by pushing the knob down.

Max. input pressure	25 bar
Max. medium temperature	60 °C
Max. ambient temperature	60 °C
DN	50
Housing	Aluminium, painted silver
Sealant	NBR
Flow rate	50000 l/min
Flow rate measurement	At P ₁ = 8 bar, P ₂ = 6 bar and pressure drop Δ _p = 1 bar

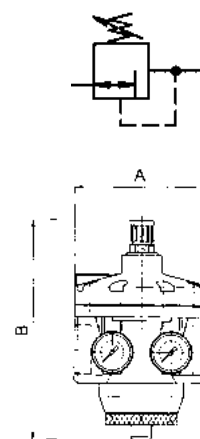

Pressure regulator with 2 pressure gauges for input and output pressure

Art. No.	Type No.	Thread	Control range bar	Pressure gauge display bar	A mm	B mm
101259	637.101	G 1 1/2	0,1 - 3	0 - 4	188.0	261.0
101260	637.102	G 1 1/2	0,2 - 6	0 - 10	188.0	261.0
101261	637.103	G 1 1/2	0,5 - 10	0 - 16	188.0	261.0
101262	637.104	G 1 1/2	0,5 - 16	0 - 25	188.0	261.0
101263	637.201	G 2	0,1 - 3	0 - 4	160.0	261.0
101264	637.202	G 2	0,2 - 6	0 - 10	160.0	261.0
101265	637.203	G 2	0,5 - 10	0 - 16	160.0	261.0
101266	637.204	G 2	0,5 - 16	0 - 25	160.0	261.0



637.203

→ We recommend always using these controllers in conjunction with our filters with metal bowl and manual drain valve, »Standard« series, see on page 35-36

Accessories / spare parts

Art. No.	Type No.	Description
101267	22.6203.4	Set of wearing parts



22.6203.4

Inline pressure regulators up to 200 bar



Inline pressure regulator for up to 200 bar input pressure; suitable for compressed air, nitrogen and other neutral, compressed gases.

Max. operating pressure	200 bar
Operating temperature	-10 to 90 °C
Housing	Brass
Sealant	NBR

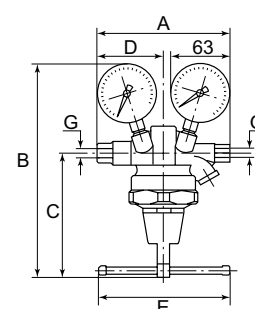

Inline pressure regulator, incl. pressure gauge

Art. No.	Type No.	Thread	Adjustment	Control range bar	Flow rate l/min	A mm	B mm	C mm	D mm	E mm
101268	639.11	G 1/4 IT	Knob	1 - 50	2500	162.0	188.5	100.0	76.0	50.0
101269	639.12	G 1/4 IT	Rotary switch	1 - 100	2700	162.0	213.5	125.0	76.0	130.0
101270	639.13	G 1/4 IT	Rotary switch	1 - 150	2900	162.0	213.5	125.0	76.0	130.0



639.12

Cylinder pressure regulators

for cylinder pressure 200 bar and 300 bar



Single-stage type of construction acc. to DIN EN ISO 2503, with shut-off valve and safety valve as well as pressure gauges for the cylinder contents and working pressure.

Housing Pressed brass



487.36

Cylinder pressure regulator, cylinder pressure 200 bar, for non-flammable gases

Art. No.	Type No.	Gas type	Indicating range bar	Working pressure bar	Cylinder connection
101271	487.35	Oxygen	0 - 200/315	0 - 10	Nut 3/4
101272	487.36	Oxygen	0 - 200/315	0 - 20	Nut 3/4
101273	487.38	Compressed air	0 - 200/315	0 - 10	5/8 male
101274	487.38 H	Compressed air	0 - 200/315	0 - 20	5/8 male
101275	487.39	Nitrogen	0 - 200/315	0 - 10	W 24.32 x 1/14
101276	487.39 H	Nitrogen	0 - 200/315	0 - 20	W 24.32 x 1/14
101277	487.41	Carbon dioxide	0 - 200/315	0 - 10	W 21.8 x 1/14
101278	487.41 H	Carbon dioxide	0 - 200/315	0 - 20	W 21.8 x 1/14
101279	487.42	Argon/helium	0 - 200/315	0 - 10	W 21.8 x 1/14

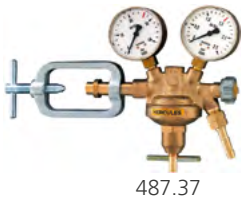

487.37

Cylinder pressure regulator, cylinder pressure 200 bar, for flammable gases

Art. No.	Type No.	Gas type	Indicating range bar	Working pressure bar	Cylinder connection
101280	487.37	Acetylene	0 - 18/40	0 - 1.5	Yoke
101281	487.43	Hydrogen, methane, illuminating gas, natural gas	0 - 200/315	0 - 10	W 21.8 x 1/14 ccw



489.10

Cylinder pressure regulator, cylinder pressure 200 bar, for non-flammable gases, with flowmeter

Art. No.	Type No.	Gas type	Indicating range bar	Flowmeter l/min	Cylinder connection
101282	489.10	Argon	0 - 200/315	0 - 20	W 21.8 x 1/14 i

Cylinder pressure regulator, cylinder pressure 200 bar, for flammable gases, with flowmeter

Art. No.	Type No.	Gas type	Indicating range bar	Flowmeter l/min	Cylinder connection
101283	489.11	Forming gas	0 - 200/315	0 - 30	W 21.8 x 1/14 LHi



488.38

Cylinder pressure regulator, cylinder pressure 300 bar, for non-flammable gases

Art. No.	Type No.	Gas type	Indicating range bar	Working pressure bar	Cylinder connection
101284	488.35	Oxygen	0 - 300/400	0 - 10	W 30 x 2
101285	488.38	Compressed air	0 - 300/400	0 - 10	W 30 x 2
101286	488.39	Nitrogen	0 - 300/400	0 - 10	W 30 x 2
101287	488.39 H	Nitrogen	0 - 300/400	0 - 20	W 30 x 2

Cylinder pressure regulator, cylinder pressure 300 bar, for flammable gases

Art. No.	Type No.	Gas type	Indicating range bar	Working pressure bar	Cylinder connection
101288	488.44	Fuel gas	0 - 300/400	0 - 1.5	W 30 x 2 ccw
101289	488.43	Fuel gas	0 - 300/400	0 - 10	W 30 x 2 ccw

→ Other cylinder pressure regulators available on request

Cylinder pressure regulators

for cylinder pressure 200 bar and 300 bar

Accessories / spare parts		
Art. No.	Type No.	Description
101294	402	Working pressure gauge (oxygen), 0 - 20/40 bar
101296	405	Content pressure gauge (oxygen), 0 - 400 bar, for 300 bar
101297	401	Working pressure gauge (oxygen), 0 - 10/16 bar
101298	404	Content pressure gauge (oxygen), for 200 bar cyl. pressure
101301	GS 30	Protective caps for pressure gauge Ø 63, red
101302	GS 31	Protective caps for pressure gauge Ø 63, blue
101290	424	Content pressure gauge (neutral), 0 - 315 bar, for 200 bar
101291	421	Working pressure gauge (neutral), 0 - 10/16 bar
101292	422	Working pressure gauge (neutral), 0 - 20/40 bar
101293	420	Working pressure gauge (argon), 0 - 30 l/min
101295	425	Content pressure gauge (neutral), 0 - 400 bar, for 300 bar
101299	411	Working pressure gauge (acetylene), 0 - 2.5 bar
101300	413	Content pressure gauge (acetylene)
155238	488.4.942	Replacement seal for cylinder pressure 300 bar
118852	444.4.942	Connection seal made of PA, for cylinder pressure 300 bar



424



420



404



GS 31



488.4.942



444.4.942



1

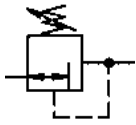

Pressure regulators

for water



Diaphragm pressure regulators with non-self relieving design for water, compressed air and non-aggressive gases.

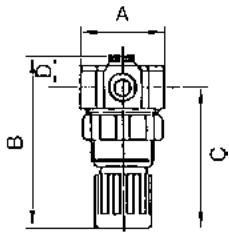

Max. input pressure	25 bar
Max. medium temperature	50 °C
Max. ambient temperature	50 °C
Housing	Brass
Spring bonnet	POM
Sealant	NBR
Diaphragms	NBR
Flow rate	18 l/min
Flow rate measurement	At $P_1 = 6$ bar, $P_2 = 5$ bar (water) and pressure drop $\Delta p = 4$ bar



484.06

Pressure regulator for water, incl. pressure gauge

Art. No.	Type No.	Thread	Control range bar	Pressure gauge display bar	A mm	B mm	C mm	D mm
101303	484.03	G 1/4	0,1 - 3	0 - 4	40.0	78.0	63.0	15.0
101304	484.06	G 1/4	0,2 - 6	0 - 10	40.0	78.0	63.0	15.0
101305	484.10	G 1/4	0,5 - 10	0 - 16	40.0	78.0	63.0	15.0



MV 30

R 11-55

22.484.4

Accessories / spare parts

Art. No.	Type No.	Description
100344	MV 30	Mounting bracket with nut M30x1.5
100345	R 11-55	Nut M30x1.5
101306	22.484.4	Set of wearing parts

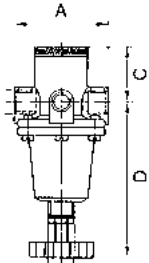

Pressure regulators

for water



Brass diaphragm pressure regulators with non-self-relieving design, specially for use with water. The regulator protects water installations against high system pressure, prevents pressure fluctuations and helps reduce water consumption. Undesirable flow noises are kept to a minimum.



484.25 B

Max. input pressure	40 bar
Temperature range	5 to 90 °C
Medium	Water, nitrogen and argon
Housing	Brass
Sealant	NBR
Diaphragms	NBR
Flow rate measurement	At $P_1 = 7$ bar, $P_2 = 6$ bar and pressure drop $\Delta p = 1$ bar

Pressure regulator for water, incl. pressure gauge

Art. No.	Type No.	Thread	Wheel	Control range bar	Flow rate l/min	A mm	C mm	D mm
101307	484.25 B	G 1/4	Plastic	0,5 - 6	2.5	45.0	23.0	81.0
101308	484.25 C	G 1/4	Plastic	0,5 - 10	2.5	45.0	23.0	81.0
101309	484.35 B	G 1/2	Plastic	0,5 - 6	15	72.0	30.0	123.0
101310	484.35 C	G 1/2	Plastic	0,5 - 10	15	72.0	30.0	123.0
101311	484.45 B	G 1	Rotary switch	0,5 - 6	24	114.0	41.0	175.0
101312	484.45 C	G 1	Rotary switch	0,5 - 10	24	114.0	41.0	175.0
101313	484.55 B	G 1 1/2	Rotary switch	0,5 - 6	56	114.0	50.0	183.0
101314	484.55 C	G 1 1/2	Rotary switch	0,5 - 10	56	114.0	50.0	183.0



484.45 B

Accessories / spare parts for pressure regulator G 1/4

Art. No.	Type No.	Description
101315	484.201	2 nuts M20x1.5 and 2 washers
101316	484.202	Mounting bracket with nut and washer
101317	484.203	Sealing cone, complete
101318	484.204	Diaphragm, complete

**Accessories / spare parts for pressure regulator G 1/2**

Art. No.	Type No.	Description
101321	484.301	2 nuts M28x1.5 and 2 washers
101155	484.302	Mounting bracket with nut and washer
101322	484.303	Sealing cone, complete
101323	484.304	Diaphragm, complete

**Accessories / spare parts for pressure regulator G 1**

Art. No.	Type No.	Description
100914	H 88	Mounting bracket with 2 screws
101324	484.403	Sealing cone, complete
101325	484.404	Diaphragm, complete



H 88

Accessories / spare parts for pressure regulator G 1 1/2

Art. No.	Type No.	Description
100914	H 88	Mounting bracket with 2 screws
101326	484.503	Sealing cone, complete
101325	484.404	Diaphragm, complete

Pressure regulators

for water and liquid



Pressure regulator with pressure-reduced single-seated piston valve or single-seated diaphragm valve and built-in strainer. Specially designed for use with water. The device is also suitable for all other applications involving neutral non-sticky liquids, air and neutral non-flammable gases.

Min. pressure drop	1 bar
Max. operating temperature	75 °C
Housing	Bronze (Rg5)
Sealant	NBR-SBR
Internal parts	Plastic, brass, stainless steel

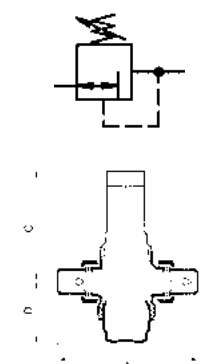
**Pressure regulator for drinking water (without DVGW approval), high secondary (outlet) pressure (max. 12 bar)**

Art. No.	Type No.	Thread	Max. input pressure bar	Min. primary (inlet) pressure bar	Control range bar	Flow rate kvs value m ³ /h	A mm	B mm	D mm
101327	100.111	R 1/2	25	2.5	1,5 - 12	2.9	137.0	177.0	27.0
101328	100.112	R 3/4	25	2.5	1,5 - 12	3.9	141.0	177.0	27.0
101329	100.113	R 1	25	2.5	1,5 - 12	5.4	160.0	178.5	28.5
101330	100.114	R 1 1/4	25	2.5	1,5 - 12	6.1	177.2	234.0	47.0
101331	100.115	R 1 1/2	25	2.5	1,5 - 12	12	210.0	379.0	59.0
101332	100.116	R 2	25	2.5	1,5 - 12	13	210.0	381.0	61.0



100.112

100.115

Pressure regulator for water, low secondary (outlet) pressure (max. 2 bar)

Art. No.	Type No.	Thread	Max. input pressure bar	Min. primary (inlet) pressure bar	Control range bar	Flow rate kvs value m ³ /h	A mm	B mm	D mm
101333	100.121	R 1/2	16	1.2	0,2 - 2	2.9	137.0	154.0	27.0
101334	100.122	R 3/4	16	1.2	0,2 - 2	3.9	141.0	154.0	27.0



100.122

1

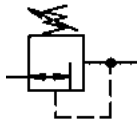

Pressure regulators

for water and liquid

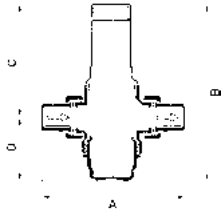

Pressure regulator for water, low secondary (outlet) pressure (max. 2 bar)

Art. No.	Type No.	Thread	Max. input pressure bar	Min. primary (inlet) pressure bar	Control range bar	Flow rate kvs value m ³ /h	A mm	B mm	D mm
101335	100.123	R 1	16	1.2	0,2 - 2	5.4	160.6	154.0	28.5
101336	100.124	R 1 1/4	16	1.2	0,2 - 2	6.1	177.2	156.0	47.0
101337	100.125	R 1 1/2	16	1.2	0,2 - 2	12	210.0	359.0	59.0
101338	100.126	R 2	16	1.2	0,2 - 2	13	210.0	361.0	61.0



Spare parts for high-pressure type (max. 12 bar)

Art. No.	Type No.	Description
101339	100.401	Cartridge for R 1/2, R 3/4 and R 1
101340	100.402	Cartridge for R 1 1/4
101341	100.403	Seal kit for R 1 1/2
101342	100.404	Seal kit for R 2



Spare parts for low-pressure type (max. 2 bar)

Art. No.	Type No.	Description
101343	100.501	Seal kit for R 1/2
101344	100.502	Seal kit for R 3/4
101345	100.503	Seal kit for R 1
101346	100.504	Seal kit for R 1 1/4
101347	100.505	Seal kit for R 1 1/2
101348	100.506	Seal kit for R 2



Pressure regulators

for drinking water, DVGW-tested acc. to EN 1567



Pressure regulator with pressure-reduced single-seated diaphragm valve and built-in strainer. Specially designed for use in domestic water installations. The device is also suitable for all other applications involving water, neutral non-sticky liquids, air and neutral non-flammable gases.

Max. input pressure	16 bar
Min. primary (inlet) pressure	2.5 bar
Min. pressure drop	1 bar
Max. operating temperature	75 °C
Control range	1,5 - 6 bar
Housing	Bronze (Rg5)
Diaphragms	NBR
Sealant	NBR-SBR
Internal parts	Plastic, brass, stainless steel



Pressure regulator for drinking water, DVGW-tested acc. to EN 1567

Art. No.	Type No.	Thread	Spring bonnet	DN	Flow rate kvs value m ³ /h	A mm	B mm	C mm	D mm
101349	100.101	R 1/2	PA 6	15	2.9	137.0	134.7	107.7	27.0
101350	100.102	R 3/4	PA 6	20	3.9	157.0	134.7	107.7	27.0
101351	100.103	R 1	PA 6	25	5.4	164.0	134.7	107.7	27.0
101352	100.104	R 1 1/4	PA 6	32	6.1	177.0	151.5	109.0	42.5

Pressure regulators

for drinking water, DVGW-tested acc. to EN 1567



Pressure regulator for drinking water, without DVGW approval

Art. No.	Type No.	Thread	Spring bonnet	DN	Flow rate kvs value m ³ /h	A mm	B mm	C mm	D mm
101353	100.105	R 1 1/2	Grey cast iron	40	9	210.0	294.0	243.0	51.0
101354	100.106	R 2	Grey cast iron	50	13	210.0	294.0	241.0	53.0

Spare parts

Art. No.	Type No.	Description
101355	100.301	Cartridge for R 1/2 and R 3/4
101356	100.302	Cartridge for R 1
101357	100.303	Cartridge for R 1 1/4
101358	100.304	Seal kit for R 1 1/2
101359	100.305	Seal kit for R 2

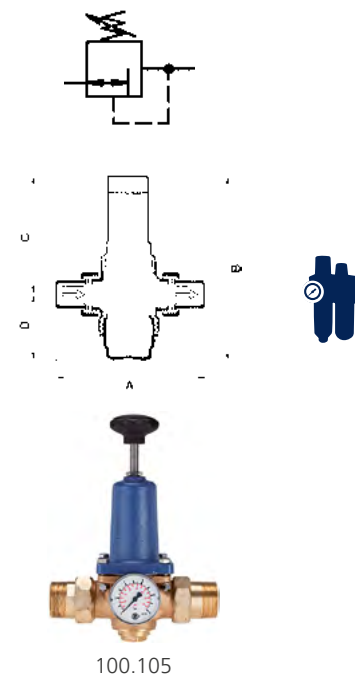

100.105

Pressure regulators

for drinking water, DVGW-tested



Diaphragm pressure regulators with pressure-reduced single-seated valve and built-in strainer. These pressure regulators, which are independent of inlet pressure, protect domestic water installations against excessive supply pressure. They can also be used for commercial or industrial purposes providing their specification is adequate.

Medium	Drinking water, nitrogen, compressed air, neutral liquids
Housing	Brass
Spring bonnet	Plastic
Sealant	NBR

Pressure regulator for drinking water, with transparent sieve cup, DVGW-tested

Art. No.	Type No.	Thread	Max. input pressure bar	Control range bar	Flow rate kvs value m ³ /h	A mm	B mm	C mm	D mm
101360	100.01	R 1/2	16	1,5 - 6	2.4	140.0	147.0	89.0	58.0
101361	100.02	R 3/4	16	1,5 - 6	3.1	160.0	147.0	89.0	58.0
101362	100.03	R 1	16	1,5 - 6	7.6	180.0	175.0	111.0	64.0
101363	100.04	R 1 1/4	16	1,5 - 6	9.1	200.0	175.0	111.0	64.0
101364	100.05	R 1 1/2	16	1,5 - 6	12.6	225.0	299.0	173.0	126.0
101365	100.06	R 2	16	1,5 - 6	12	255.0	299.0	173.0	126.0



100.03

Pressure regulator for drinking water, with brass sieve cup, DVGW approval not necessary

Art. No.	Type No.	Thread	Max. input pressure bar	Control range bar	Flow rate kvs value m ³ /h	A mm	B mm	C mm	D mm
101366	100.11	R 1/2	25	1,5 - 12	2.4	140.0	152.0	96.0	56.0
101367	100.12	R 3/4	25	1,5 - 12	3.1	160.0	152.0	96.0	56.0
101368	100.13	R 1	25	1,5 - 12	7.6	180.0	217.0	140.0	77.0
101369	100.14	R 1 1/4	25	1,5 - 12	9.1	200.0	217.0	140.0	77.0
101370	100.15	R 1 1/2	25	1,5 - 12	12.6	225.0	285.0	172.0	113.0
101371	100.16	R 2	25	1,5 - 12	12	255.0	285.0	172.0	113.0
101372	100.21	R 1/2	25	0,5 - 2	2.4	140.0	204.0	148.0	56.0
101373	100.22	R 3/4	25	0,5 - 2	3.1	160.0	204.0	148.0	56.0
101374	100.23	R 1	25	0,5 - 2	7.6	180.0	262.0	185.0	77.0



100.13

➔ With brass sieve cup the maximum inlet pressure increases to 25 bar

1



Accessories / spare parts for pressure regulator with control range 1.5 - 6 bar

Art. No.	Type No.	Description
101387	ZR 06 A	Spanner for pressure regulator
101375	100/201	Valve replacement kit for R 1/2 and R 3/4
101378	100/221	Replacement strainer for R 1/2 and R 3/4
101381	100/241	Transparent strainer cup for R 1/2 and R 3/4
101384	100/261	Brass strainer cup for R 1/2 and R 3/4
101244	217-KD	Pressure gauge Ø 63 mm, G 1/4 ET, 0 - 10 bar/145 psi
101388	VST06-1/2A	Threaded fitting, screw fitting 1/2 for regulators R 1/2
101389	VST06-3/4A	Threaded fitting, screw fitting 3/4 for regulators R 3/4
101376	100/204	Valve replacement kit for R 1 and R 1 1/4
101379	100/224	Replacement strainer for R 1 and R 1 1/4
101382	100/244	Transparent strainer cup for R 1 and R 1 1/4
101385	100/264	Brass strainer cup for R 1 and R 1 1/4
101390	VST06-1A	Threaded fitting, screw fitting 1 for regulators R 1
101391	VST06-11/4 A	Threaded fitting, screw fitting 1 1/4 for regulators R 1 1/4
101377	100/203	Valve replacement kit for R 1 1/2 and R 2
101380	100/223	Replacement strainer for R 1 1/2 and R 2
101383	100/243	Transparent strainer cup for R 1 1/2 and R 2
101386	100/263	Brass strainer cup for R 1 1/2 and R 2
101392	VST06-11/2 A	Threaded fitting, screw fitting 1 1/2 for regulators R 1 1/2
101393	VST06-2A	Threaded fitting, screw fitting 2 for regulators R 2



Accessories / spare parts for pressure regulator with control range 1.5 - 12 bar

Art. No.	Type No.	Description
101387	ZR 06 A	Spanner for pressure regulator
101375	100/201	Valve replacement kit for R 1/2 and R 3/4
101378	100/221	Replacement strainer for R 1/2 and R 3/4
101384	100/261	Brass strainer cup for R 1/2 and R 3/4
101398	218-KD	Pressure gauge Ø 63 mm, G 1/4 ET, 0 - 16 bar/230 psi
101388	VST06-1/2A	Threaded fitting, screw fitting 1/2 for regulators R 1/2
101389	VST06-3/4A	Threaded fitting, screw fitting 3/4 for regulators R 3/4
101394	100/202	Valve replacement kit for R 1 and R 1 1/4
101395	100/222	Replacement strainer for R 1 and R 1 1/4
101397	100/262	Brass strainer cup for R 1 and R 1 1/4
101390	VST06-1A	Threaded fitting, screw fitting 1 for regulators R 1
101391	VST06-11/4 A	Threaded fitting, screw fitting 1 1/4 for regulators R 1 1/4
101377	100/203	Valve replacement kit for R 1 1/2 and R 2
101380	100/223	Replacement strainer for R 1 1/2 and R 2
101386	100/263	Brass strainer cup for R 1 1/2 and R 2
101392	VST06-11/2 A	Threaded fitting, screw fitting 1 1/2 for regulators R 1 1/2
101393	VST06-2A	Threaded fitting, screw fitting 2 for regulators R 2



Accessories / spare parts for pressure regulator with control range 0.5 - 2 bar

Art. No.	Type No.	Description
101387	ZR 06 A	Spanner for pressure regulator
101399	100/211	Valve replacement kit for R 1/2 and R 3/4
101378	100/221	Replacement strainer for R 1/2 and R 3/4
101384	100/261	Brass strainer cup for R 1/2 and R 3/4
101223	215-KD	Pressure gauge Ø 63 mm, G 1/4 ET, 0 - 4 bar/58 psi
101388	VST06-1/2A	Threaded fitting, screw fitting 1/2 for regulators R 1/2
101389	VST06-3/4A	Threaded fitting, screw fitting 3/4 for regulators R 3/4
101400	100/212	Valve replacement kit for R 1
101395	100/222	Replacement strainer for R 1 and R 1 1/4
101397	100/262	Brass strainer cup for R 1 and R 1 1/4
101390	VST06-1A	Threaded fitting, screw fitting 1 for regulators R 1

Pressure regulators

»Saxonia« series, for drinking water, DVGW-tested



Diaphragm pressure regulators with pressure-reduced single-seated valve and built-in strainer. These pressure regulators, which are independent of inlet pressure, protect domestic water installations against excessive supply pressure. They can also be used for commercial or industrial purposes providing their specification is adequate.

Max. input pressure	16 bar
Max. operating temperature	30 °C
Control range	1,5 - 6 bar
Medium	Drinking water
Housing	Brass
Strainer cup	Plastic, with control dial for back pressure
Spring bonnet	Plastic
Sealant	NBR

Pressure regulator for drinking water, incl. pressure gauge, DVGW-tested

Art. No.	Type No.	Thread	Flow rate kvs value m ³ /h	DN	A mm	B mm
101401	100.32	R 3/4	3.4	20	90.0	158.0
101402	100.33	R 1	5.3	25	100.0	184.0
101403	100.34	R 1 1/4	8.6	32	130.0	228.0

Spare parts

Art. No.	Type No.	Description
101404	100/320	Valve replacement kit for R 3/4 and R 1
101406	100/321	Replacement strainer for R 3/4 and R 1
101408	106	Pressure gauge Ø 50 mm, G 1/4 ET, 0 - 10 bar
101405	100/340	Valve replacement kit for R 1 1/4
101407	100/341	Replacement strainer for R 1 1/4

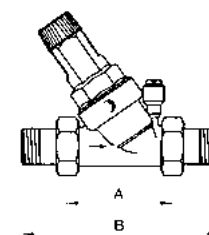
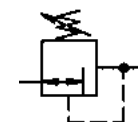

100.33

100/320

100/321

106

1

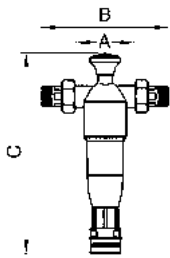

Back-flushing filters

for drinking water, DVGW-tested



For filtering drinking and domestic water in addition to well, process and cooling water for once-through cooling systems. These filters protect the water pipes and all water-carrying parts of the system on the downstream side against malfunctions and corrosion damage. The filter candle must be cleaned manually at regular intervals by back-flushing (flushing out dirt particles). Integrated back-flushing element with suction elements, back-flushing lever, wing lever for back-flushing element, hose connection for flushing water.

Max. input pressure	16 bar
Ambient temperature	5 to 40 °C
Water temperature	5 to 30 °C
Housing	Brass
Strainer cup	Impact-resistant plastic
Lower mesh width	90 µm
Upper mesh width	110 µm
Flow rate measurement	At pressure drop $\Delta_p = 0.2$ bar



100.44

Back-flushing filter, DVGW-tested

Art. No.	Type No.	Thread	Flow rate kvs value m ³ /h	DN	A mm	B mm	C mm
101409	100.42	R 3/4	3	20	80.0	184.0	352.5
101410	100.43	R 1	3.5	25	80.0	184.0	352.5
101411	100.44	R 1 1/4	4	32	106.4	228.0	352.5



100/421



100/422

Spare parts

Art. No.	Type No.	Description
101412	100/421	Filter insert
101413	100/422	Plastic bowl

Fine filters

»Bavaria« series for drinking water, DVGW-tested



For filtering drinking and domestic water in addition to well, process and cooling water for once-through cooling systems. These filters protect the water pipes and all water-carrying parts of the system on the downstream side against malfunctions and corrosion damage.

Max. input pressure	16 bar
Max. operating temperature	30 °C
Housing	Brass
Strainer cup	Special impact-resistant plastic
Filter rating	90 µm

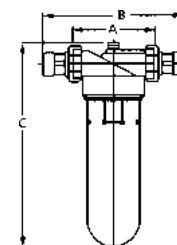

Fine filter, DVGW-tested

Art. No.	Type No.	Thread	Flow rate kvs value m ³ /h	DN	A mm	B mm	C mm
101414	100.62	R 3/4	4	20	120.0	206.0	300.0
101415	100.63	R 1	5.5	25	120.0	206.0	300.0
101416	100.64	R 1 1/4	6	32	120.0	220.0	300.0

Fine filter, without DVGW approval

Art. No.	Type No.	Thread	Flow rate kvs value m ³ /h	DN	A mm	B mm	C mm
101417	100.65	R 1 1/2	9	40	140.0	254.0	290.0
101418	100.66	R 2	12	50	140.0	274.0	290.0



100.63

Spare parts

Art. No.	Type No.	Description
101419	100/621	Filter insert for R 3/4, R 1 and R 1 1/4
101421	100/622	Plastic bowl for R 3/4, R 1 and R 1 1/4
101420	100/651	Filter insert for R 1 1/2 and R 2
101422	100/652	Plastic bowl for R 1 1/2 and R 2



100/621



100/622



100/651

1

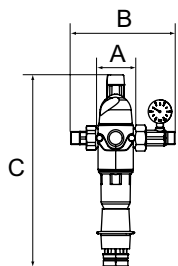

Back-flushing filters with pressure regulator

for drinking water, DVGW-tested



Combined station for filtering and regulating the pressure of drinking and domestic water in addition to well, process and cooling water for once-through cooling systems, consisting of a diaphragm pressure regulator with a pressure-reduced single-seated valve and a back-flushing filter.

The filter candle must be cleaned manually at regular intervals by back-flushing (flushing out dirt particles). Integrated back-flushing element with suction elements, back-flushing lever, wing lever for back-flushing element, hose connection for flushing water.



100.54

Max. input pressure	16 bar
Ambient temperature	5 to 40 °C
Water temperature	5 to 30 °C
Control range	2 - 6 bar
Housing	Brass
Strainer cup	Impact-resistant plastic
Lower mesh width	90 µm
Upper mesh width	110 µm
Flow rate measurement	At pressure drop $\Delta p = 0.2$ bar

Back-flushing filter with pressure regulator, incl. pressure gauge, DVGW-tested

Art. No.	Type No.	Thread	Flow rate kvs value m ³ /h	DN	A mm	B mm	C mm
101423	100.52	R 3/4	3	20	79.7	213.0	392.8
101424	100.53	R 1	3.5	25	79.7	213.0	392.8
101425	100.54	R 1 1/4	4	32	79.7	213.0	392.8



100/421



100/422

Spare parts

Art. No.	Type No.	Description
101412	100/421	Filter insert
101413	100/422	Plastic bowl

Pressure limiting valves

EASY

Manually adjustable overflow valves.
For protecting pneumatic systems against damage caused by excess pressure.

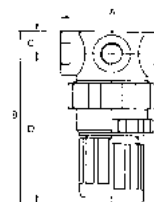

490.10



Max. medium temperature	60 °C
Max. ambient temperature	60 °C
Housing	Die-cast zinc, painted silver
Spring bonnet	POM/brass
Sealant	NBR
Diaphragms	NBR

Pressure limiting valve incl. pressure gauge

Art. No.	Type No.	Thread	Adjustment range bar	Pressure gauge display bar	A mm	B mm	C mm	D mm
101463	490.02	G 1/4	0.1 - 2	0 - 2,5	43.0	70.0	10.0	60.0
101464	490.03	G 1/4	0.1 - 3	0 - 4	43.0	70.0	10.0	60.0
101465	490.07	G 1/4	0.15 - 7	0 - 10	43.0	70.0	10.0	60.0
101466	490.10	G 1/4	0.5 - 10	0 - 16	43.0	70.0	10.0	60.0
101467	491.03	G 1/2	0.1 - 3	0 - 4	82.0	162.0	129.0	33.0
101468	491.05	G 1/2	0.5 - 5.5	0 - 10	82.0	162.0	129.0	33.0
101469	491.10	G 1/2	0.5 - 10	0 - 16	82.0	162.0	129.0	33.0

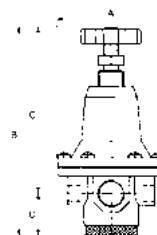

491.10

Accessories / spare parts for pressure limiting valve G 1/4

Art. No.	Type No.	Description
100344	MV 30	Mounting bracket with nut M30x1.5
100345	R 11-55	Nut M30x1.5
101471	569-2	Silencer
100290	567-2/M	Silencer, sintered bronze, with brass hexagon nut and thread
101470	22.490.4	Set of wearing parts



MV 30

R 11-55



569-2

567-2/M

Accessories / spare parts for pressure limiting valve G 1/2

Art. No.	Type No.	Description
100836	75/2	Mounting bracket with nut and washer
100292	567-4/M	Silencer, sintered bronze, with brass hexagon nut and thread
101472	569-4	Silencer
101473	22.491.4	Set of wearing parts



22.490.4

75/2



22.491.4

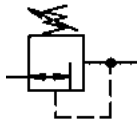

Pressure regulators

non-reversible



Diaphragm pressure regulators with non-self-relieving design and non-pressure-reduced single-seated valve. Very precise adjustment and good response characteristic because there are only a few moving parts and hence minimal friction. Ideal for compressed air, nitrogen and other neutral, non-flammable gases, but only suitable for liquids with comparatively low flow rates.

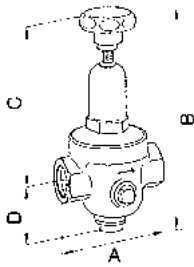

Max. temperature range	75 °C
Housing	Red brass 2.1096.01
Sealant	NBR

DRV 200 pressure regulator, standard type

Art. No.	Type No.	Thread	Max. input pressure bar	Reduction ratio max.	Control range bar	Flow rate kvs value m ³ /h	A mm	B mm	D mm
101426	200.01	G 1/4	25	10:1	1,5 - 8	0.5	70.0	167.0	47.0
101427	200.02	G 3/8	25	10:1	1,5 - 8	0.6	70.0	168.0	47.0
101428	200.03	G 1/2	25	10:1	1,5 - 8	1.2	85.0	188.5	46.5
101429	200.04	G 3/4	25	10:1	1,5 - 8	1.3	85.0	189.5	46.5
101430	200.05	G 1	25	10:1	1,5 - 8	1.6	95.0	242.0	56.0
101431	200.06	G 1 1/4	25	10:1	1,5 - 8	4.2	104.0	323.0	61.0
101432	200.07	G 1 1/2	25	10:1	1,5 - 8	4.5	108.0	323.0	61.0
101433	200.08	G 2	25	10:1	1,5 - 8	7.2	146.5	376.0	70.0



DRV 250 pressure regulator, low-pressure type

Art. No.	Type No.	Thread	Max. input pressure bar	Reduction ratio max.	Control range bar	Flow rate kvs value m ³ /h	A mm	B mm	D mm
101434	300.01	G 1/4	25	20:1	0,2 - 2	0.5	70.0	185.5	45.5
101435	300.02	G 3/8	25	20:1	0,2 - 2	0.6	70.0	185.5	45.5
101436	300.03	G 1/2	25	20:1	0,2 - 2	1.2	85.0	232.5	46.5



DRV 225 pressure regulator, high-pressure type

Art. No.	Type No.	Thread	Max. input pressure bar	Reduction ratio max.	Control range bar	Flow rate kvs value m ³ /h	A mm	B mm	D mm
101437	400.01	G 1/4	40	6:1	1,5 - 20	0.5	70.0	188.0	47.0
101438	400.02	G 3/8	40	6:1	1,5 - 20	0.6	70.0	188.0	47.0
101439	400.03	G 1/2	40	6:1	1,5 - 20	1.2	85.0	228.5	46.5
101440	400.04	G 3/4	40	6:1	1,5 - 20	1.3	85.0	228.5	46.5
101441	400.05	G 1	40	6:1	1,5 - 20	1.6	95.0	257.0	56.0
101442	400.06	G 1 1/4	40	6:1	1,5 - 20	4.2	104.0	385.0	61.0
101443	400.07	G 1 1/2	40	6:1	1,5 - 20	4.5	108.0	392.0	61.0
101444	400.08	G 2	40	6:1	1,5 - 20	7.2	146.5	419.0	70.0



➔ Other types available on request

Spare parts for pressure regulator DRV 200, standard type

Art. No.	Type No.	Description
101445	22.201.4	Set of wearing parts for G 1/4
101244	217-KD	Pressure gauge Ø 63 mm, G 1/4 ET, 0 - 10 bar/145 psi
101446	22.202.4	Set of wearing parts for G 3/8
101447	22.203.4	Set of wearing parts for G 1/2
101448	22.204.4	Set of wearing parts for G 3/4
101449	22.205.4	Set of wearing parts for G 1
101450	22.206.4	Set of wearing parts for G 1 1/4
101451	22.207.4	Set of wearing parts for G 1 1/2
101452	22.208.4	Set of wearing parts for G 2

**Spare parts for pressure regulator DRV 250, low-pressure type**

Art. No.	Type No.	Description
101453	22.301.4	Set of wearing parts for G 1/4
101223	215-KD	Pressure gauge Ø 63 mm, G 1/4 ET, 0 - 4 bar/58 psi
101454	22.302.4	Set of wearing parts for G 3/8
101455	22.303.4	Set of wearing parts for G 1/2

Spare parts for pressure regulator DRV 225, high-pressure type

Art. No.	Type No.	Description
101456	22.401.4	Set of wearing parts for G 1/4
101462	219-KD	Pressure gauge Ø 63 mm, G 1/4 ET, 0 - 25 bar/360 psi
101457	22.402.4	Set of wearing parts for G 3/8
101458	22.403.4	Set of wearing parts for G 1/2
101459	22.404.4	Set of wearing parts for G 3/4
101460	22.405.4	Set of wearing parts for G 1
101461	22.406.4	Set of wearing parts for G 1 1/4



1

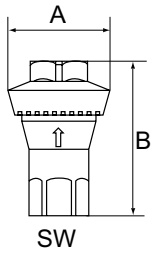

Inline pressure regulators

for pneumatic applications

EASY

This single-acting diaphragm regulator can be installed in any pneumatic system. Since the pressure is preset in the factory and cannot be altered, the product is also tamper-proof.

We recommend mounting the regulator directly on the tool to make sure the correct pressure is applied. In this case, the tool is never stressed by the higher pressure of the supply system and is protected against pressure fluctuations in hoses, pipes, etc.

Energy efficiency and economic efficiency can be achieved by using an inline pressure regulator.

Max. operating pressure	18 bar
Temperature range	0 to 60 °C
Housing	Zinc
Internal parts	Brass, NBR, stainless steel
Flow rate measurement	At P ₁ = 12 bar and pressure drop Δ _p = 0.5 bar



637.15

Inline pressure regulator, 2 x female thread, non-self-relieving

Art. No.	Type No.	Thread	Working pressure (preset) bar	Flow rate l/min	a/f mm	A mm	B mm
101494	637.11	G 1/4	1	400	17	34.0	52.0
101495	637.13	G 1/4	2	600	17	34.0	52.0
101496	637.15	G 1/4	3	700	17	34.0	52.0
101497	637.17	G 1/4	4	700	17	34.0	52.0
101498	637.18	G 1/4	5	700	17	34.0	52.0
101499	637.19	G 1/4	6	800	17	34.0	52.0
101500	637.21	G 1/4	6.5	800	17	34.0	52.0
101501	637.22	G 1/4	7	800	17	34.0	52.0

→ Pressure tolerance:

Variants with preset working pressure < 4 bar: +/- 0.3 bar (air, P₁ = 6 bar, 10 NI/min)

Variants with preset working pressure ≥ 4 bar: +/- 10 % (air, P₁ = 10 bar, 10 NI/min)

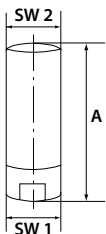

Inline pressure regulators

for pneumatic applications, with self-relieving

PLUS

The majority of pneumatic tools are connected directly to the compressed air supply by means of a quick disconnect coupling, in other words they tend to be supplied with a higher pressure than is actually required. Which increases consumption and leads to tool overload.

Added safety is provided by the automatic self-relieving function. If the tool is disconnected from the hose, it continues to work for a short period, even though it has been switched off, owing to the residual pressure that is present on the tool side. Inadvertent operation of the tool can thus lead to serious injuries to the user (tackers or nail drivers can fire up to another ten shots).

This effect can be prevented by using the inline pressure regulators, which have a preset pressure determined by the application, thereby achieving energy efficiency and economy.



638.02

Max. operating pressure	25 bar
Temperature range	0 to 80 °C
Housing	Aluminium
Internal parts	Stainless steel, nitrile rubber, brass

Inline pressure regulator, 2 x female thread, self-relieving, dependent of inlet pressure

Art. No.	Type No.	Thread	Working pressure (preset) bar	Flow rate l/min	a/f 1 mm	a/f 2 mm	A mm
101474	638.02	G 1/4	2	500	16	19	59.0
101475	638.03	G 1/4	3	550	16	19	59.0
101476	638.04	G 1/4	4	600	16	19	59.0

Inline pressure regulators

for pneumatic applications, with self-relieving

PLUS

Inline pressure regulator, 2 x female thread, self-relieving, dependent of inlet pressure

Art. No.	Type No.	Thread	Working pressure (preset) bar	Flow rate l/min	a/f 1 mm	a/f 2 mm	A mm
101477	638.05	G 1/4	5	650	16	19	59.0
101478	638.06	G 1/4	6	700	16	19	59.0
149055	638.07	G 1/4	7	750	16	19	59.0
101479	638.08	G 1/4	8	800	16	19	59.0
101480	638.12	G 3/8	2	1400	22	25	63.0
149056	638.13	G 3/8	3	1600	22	25	63.0
101481	638.14	G 3/8	4	1800	22	25	63.0
149057	638.15	G 3/8	5	2000	22	25	63.0
101482	638.16	G 3/8	6	2200	22	25	63.0
149058	638.17	G 3/8	7	2400	22	25	63.0
101483	638.18	G 3/8	8	2600	22	25	63.0
101484	638.22	G 1/2	2	1400	27	30	68.0
149059	638.23	G 1/2	3	1600	27	30	68.0
101485	638.24	G 1/2	4	1800	27	30	68.0
149060	638.25	G 1/2	5	2000	27	30	68.0
101486	638.26	G 1/2	6	2200	27	30	68.0
149061	638.27	G 1/2	7	2400	27	30	68.0
101487	638.28	G 1/2	8	2600	27	30	68.0
149062	638.52	G 3/4	2	2500	34	40	102.0
149063	638.54	G 3/4	4	3200	34	40	102.0
149064	638.56	G 3/4	6	3900	34	40	102.0
149065	638.58	G 3/4	8	4600	34	40	102.0

Inline pressure regulator, female/male thread, self-relieving, dependent of inlet pressure

Art. No.	Type No.	Thread	Working pressure (preset) bar	Flow rate l/min	a/f 1 mm	a/f 2 mm	A mm
101488	638.32	G 1/4	2	500	16	19	69.0
101489	638.33	G 1/4	3	550	16	19	69.0
101490	638.34	G 1/4	4	600	16	19	69.0
101491	638.35	G 1/4	5	650	16	19	69.0
101492	638.36	G 1/4	6	700	16	19	69.0
149054	638.37	G 1/4	7	750	16	19	69.0
101493	638.38	G 1/4	8	800	16	19	69.0

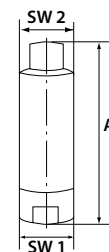
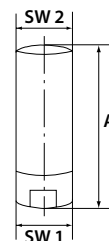

638.32

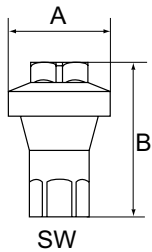

Inline pressure regulators

for water and compressed air applications



This regulator is designed as a single-acting diaphragm regulator for installation in any pipe system. It supplies a precise output value regardless of the input pressure.

Since the pressure is preset in the factory and cannot be altered, the product is also tamper-proof.

The regulator protects all downstream devices and components in the pipeline by maintaining a required constant pressure and preventing system pressure fluctuations. In combination with a nozzle, it is ideally suited for cooling or cleaning with water spray or mist.

Operating pressure	max. 10 bar (water) / 18 bar (compressed air)
Temperature range	0 to 60 °C
Housing	Nickel-plated brass
Internal parts	Brass
Sealant	NBR
Flow rate measurement	At $P_1 = 10$ bar and pressure drop $\Delta p = 0.8$ bar (air)



639.01

Inline pressure regulator, without venting

Art. No.	Type No.	Thread	Working pressure (preset) bar	Flow rate (water) l/min	Flow rate (air) l/min	a/f mm	A mm	B mm
101502	639.01	G 1/4	1	10	400	17	34.0	52.0
101503	639.02	G 1/4	2	10	600	17	34.0	52.0
101504	639.03	G 1/4	3	10	700	17	34.0	52.0
101505	639.04	G 1/4	4	10	700	17	34.0	52.0
150634	639.05	G 1/4	5	10	700	17	34.0	52.0
150635	639.06	G 1/4	6	10	800	17	34.0	52.0
150636	639.07	G 1/4	7	10	800	17	34.0	52.0
150637	639.08	G 1/4	8	10	800	17	34.0	52.0

→ Pressure tolerance:

Variants with preset working pressure < 4 bar: +/- 0.3 bar (air, $P_1 = 6$ bar, 10 NI/min)

Variants with preset working pressure ≥ 4 bar: +/- 10 % (air, $P_1 = 10$ bar, 10 NI/min)

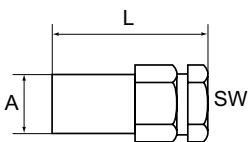

Filters

»inline« series

For integration in a pneumatic system if different system sections or tools require different air qualities.

Max. input pressure	18 bar
Temperature range	0 to 80 °C
Housing	Brass
Filter element	Nickel-plated brass
Filter rating	36 μ m
Internal parts	NBR

Filter »inline«

Art. No.	Type No.	Thread	a/f mm	A mm	L mm
101516	650.11	G 1/8 IT/IT	17	16.0	35.0
101517	650.12	G 1/4 IT/IT	19	18.0	41.0
101518	650.13	G 3/8 IT/IT	24	22.0	53.0
101519	650.14	G 1/2 IT/IT	28	28.0	60.0
101520	650.21	G 1/8 IT/ET	17	16.0	41.0
101521	650.22	G 1/4 IT/ET	19	18.0	48.0
101522	650.23	G 3/8 IT/ET	24	22.0	60.0
101523	650.24	G 1/2 IT/ET	28	28.0	70.0



650.12



650.22

Filters

»filter plug« series

For mounting on pneumatic tools and protecting them against impurities, especially in dirty or dusty working environments.

Inline filters

- Extend the service life of the tool
- Do not impair the flow
- Assure the oil mist supply to the tool

Designed for use with standard DN 7.2 couplings.

Max. working pressure	10 bar
Temperature range	0 to 90 °C
Housing	Nickel-plated steel
Filter element	Sintered bronze

Inline-filter		
Art. No.	Type No.	Thread
101524	650.91	R 1/4
101525	650.92	R 3/8



650.91

Spare part		
Art. No.	Type No.	Description
101526	650.95	Filter element



650.95

Mini pressure regulators



This preset pressure regulator guarantees optimal pressure conditions, especially in blow guns. The pressure regulator is inserted into the compressed air line. Fits onto any 1/4" thread and maintains the pressure at optimum, thus helping to reduce the costs for energy. Tamper-proof.

Max. input pressure	12 bar
Temperature range	-20 to 60 °C
Housing	Brass
Spring	Stainless steel
Flow rate	0 - 400 l/min

Mini pressure regulator				
Art. No.	Type No.	Thread	Working pressure (preset) bar	L mm
101506	638.42	G 1/4 ET/ET	2	24.0
101507	638.44	G 1/4 ET/ET	4	24.0
101508	638.46	G 1/4 ET/ET	6	24.0

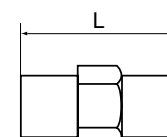

638.42



1

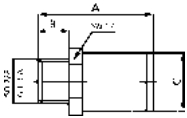

Pressure reducing valves

Industry, trade and repair shops often require working pressures of 15 bar or less. These pressure reducing valves, which are screwed directly onto the tool, enable that the pressure can be reduced to the selected working pressure.

Benefits:

- Significantly reduced risk of accidents
- Longer tool life with fewer malfunctions
- Lower noise levels at the workplace

Max. input pressure	15 bar
Housing	Brass
Connecting thread	G 1/4 female / male



637.04

Pressure reducing valve

Art. No.	Type No.	Set pressure bar	Flow rate l/min	A mm	B mm	C Ø mm	a/f mm
101509	637.02	2	300	34.0	9.0	17.0	17
101510	637.03	3	360	34.0	9.0	17.0	17
101511	637.04	4	380	34.0	9.0	17.0	17
101512	637.05	5	390	34.0	9.0	17.0	17
101513	637.06	6	405	34.0	9.0	17.0	17
101514	637.07	7	415	34.0	9.0	17.0	17
101515	637.08	8	420	34.0	9.0	17.0	17

→ Dependent on the input pressure P1, the initial pressure P2 can vary

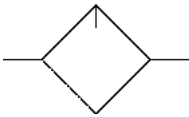

Mini oil-mist lubricators



For mounting on pneumatic impact tools (nail drivers, tackers, screwdrivers) which work intermittently. Also suitable for tools with continuous compressed air demand (grinding and polishing machines).

Fixed drip rate: Approx. 0.4 cm³ per 100 work cycles, one filling = 3000 work cycles.

Oil consumption in continuous operation (at 6 bar): 0.15 cm³ / Nm³ (varies depending on ambient temperature and oil used).

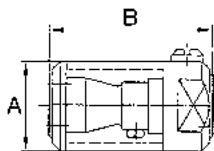

Operating pressure	2 - 15 bar
Max. medium temperature	50 °C
Max. ambient temperature	50 °C
DN	8
Oil grade	CL 32 acc. to DIN 51517-ISO VG 32
Oil bowl	Polycarbonate
Mounting position	Oil intake at the lowest point
Flow direction	any



768 K

Mini oil-mist lubricator

Art. No.	Type No.	Thread	A mm	B mm
101527	768 K	G 1/4	33.0	60.0
101528	769 K	G 3/8	33.0	60.0

→ We recommend our special pneumatic oil on page 145

Double piston pressure multiplier (boosters)

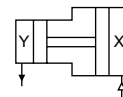

The booster increases the existing supply pressure for one or more actuators in a fixed transmission ratio (see technical data) and thus provides the required working pressure.

The booster is not suitable for applications that have a longer lasting air consumption – such as pneumatic grinders, air motors, vacuum generation via Venturi nozzles, etc.

The design uses two coupled oscillating differential pistons and integrated check valves. To avoid fluctuations in output pressure, the use of a tank for pressure build-up and storage of compressed air is recommended. Operation with filtered and unlubricated or lubricated compressed air possible (once lubricated, continuous lubrication is necessary).



Input pressure	2 - 10 bar
Housing	Anodised aluminium
Jacket	Anodised aluminium jacket
Sealant	NBR
Mounting options	Any position, with 4 mounting holes

Pressure multiplier without pressure regulator

Art. No.	Type No.	Piston Ø mm	Max. output pressure bar	Temperature range °C	Thread	P2:P1
101529	B-921	40	20	-10 to 50	G 1/8	2:1
101530	B-923	63	20	-10 to 60	G 3/8	2:1



B-923

Pressure multiplier with pressure regulator

Art. No.	Type No.	Piston Ø mm	Max. output pressure bar	Temperature range °C	Thread	P2:P1	Pressure regulator
101531	B-922	40	16	-10 to 50	G 1/8	1:1 to 1,6:1	with plastic body
101532	B-924	63	16	-10 to 60	G 3/8	1:1 to 1,6:1	with plastic body



B-922

→ For information about calculating the filling times for different tank sizes, refer to our data sheet

Accessories / spare parts

Art. No.	Type No.	Description
101533	110.45-KD	Pressure gauge Ø 40 mm, G 1/8 ET, 0 - 6 bar/87 psi
101534	110.47-KD	Pressure gauge Ø 40 mm, G 1/8 ET, 0 - 16 bar/230 psi
101535	B-938	Set of gaskets (for pressure multiplier and regulator), Ø 40
101536	B-939	Set of gaskets (for pressure multiplier and regulator), Ø 63
101537	B-930	Regulator unit (regulator, adapter, fixing parts) for G 1/8
101538	B-931	Regulator unit (regulator, adapter, fixing parts) for G 3/8



110.45-KD



B-939



B-930



B-931

Oil-water separators

»drukosep« series



For compressor capacities up to 3.5 m³/min.

Why treat condensate?

Condensate is produced whenever air is compressed.

The amount of condensate depends on the size and operating time of the compressor.

The condensate produced by oil-lubricated compressors can contain up to 2000 mg of oil per litre!

According to § 7a of the Water Resources Policy Act, this condensate must be treated in line with the latest state of the art before it can be introduced into the public sewer system.

The maximum limit is 20 mg of oil per litre of water. If the condensate is not treated, it must be collected and disposed of by a specialist firm upon proof.

»drukosep« separates the oil from the condensate with a combination of coalescence and activated carbon filters. The cleaned water can be discharged into the public sewer system, while the waste oil collects in the combination filter and can be disposed of together with it.

Benefits of »drukosep«

- Compact design
- Secure wall or floor mounting
- 3-stage combination filter
- Test glass for the cleaned condensate



SEP 2

Bowl	Polyethylene / Polypropylene
Filter element	Polypropylene / activated carbon

Oil-water separator »drukosep«

Art. No.	Type No.	Max. compressor capacity m ³ /min	Height mm	Width mm	Depth mm	Weight kg
101615	SEP 1	1.5	445.0	251.0	240.0	4.3
101616	SEP 2	2.5	545.0	251.0	240.0	5.5
101617	SEP 3	3.5	613.0	373.0	291.0	9



SEP 90



SEP 95



SEP 11

Spare parts for »drukosep« oil-water separator

Art. No.	Type No.	Description
101618	SEP 90	Oil test paper (50 strips)
101619	SEP 95	Test glass
101620	SEP 11	Replacement filter set for oil-water separator 1,5 m ³ /min
101621	SEP 22	Replacement filter set for oil-water separator 2,5 m ³ /min
101622	SEP 33	Replacement filter set for oil-water separator 3,5 m ³ /min

Drain for compressed air condensate

»drukodrain« type



Ruggedly designed, cycle-controlled drain system for controlled drainage of compressed air condensate, proven thousands of times over and ready to use immediately. In contrast with conventional clock generators, the blowing and pause times of the »drukodrain« are not set in seconds or minutes but in bar or m³/min, depending on the pneumatic system installed upstream. Efficient and reliable operation is assured.

Benefits of »drukodrain«:

- Clock generator settings according to compressed air system:
"bar" – for operating pressure
"m³/min" - for compressor or dryer capacity
- Suitable for compressor / dryer capacities up to 20 m³/min
- Integrated dirt pan and G 1/2 ball valve
- 2 m connection cable with plug (230 V / 50 Hz) included

»drukodrain« drain for compressed air condensate

Art. No.	Type No.	Voltage	Max. operating pressure bar
101623	KA 10	230 V / 50 Hz	16



KA 10

Spare parts for »drukodrain« drain for compressed air condensate

Art. No.	Type No.	Description
101624	KA 10-1	Clock generator
101625	KA 10-2	Service kit



KA 10-1



KA 10-2

Drain for compressed air condensate

»drukodrain plus« type



Compact and exceptionally reliable, level-controlled drain for compressed air condensate. The condensate enters the integrated collecting tank, in which the level is continuously monitored. When the condensate reaches the maximum mark, the pilot valve opens and the condensate is forced into the discharge line by the system pressure. The valve closes again when the level reaches the minimum mark.

Benefits of »drukodrain plus«:

- No pressure loss
- Diaphragm protected by integrated cup filter
- Test button for manual outlet
- Auto-reset function
- Suitable for all condensate types

Compressor capacity	10 m ³ /min
Dryer capacity	20 m ³ /min
Filter capacity	100 m ³ /min

»drukodrain plus« drain for compressed air condensate

Art. No.	Type No.	Voltage	Operating pressure bar
101626	KA 20	230 V AC / 50 Hz	0.2 - 16



KA 20

→ The following voltages on request:
24 VDC, 24 VAC DC, 24 VAC / 50 Hz, 110 VAC / 50 Hz, 115 V / 50 Hz

Hand-held measurement unit for industrial applications

PLUS

Portable hand-held measurement unit with integrated data logger suitable for flowmeters, for industrial applications such as measurement of consumption and flow, pressure and vacuum, temperature, residual moisture and dew point.

With its 3.5" graphical display, measured values can also be displayed on curves in colour.

Up to 100 million measured values can be stored and then transmitted to the PC via USB stick.

An additional software package also allows data to be conveniently evaluated on the PC, for example for long-term measurements/analyses or simple, quick setup of service reports.

- Universal sensor input for many current signals: 0 - 1/10 V, 0/4 - 20 mA, Pt 100, Pt 1000, pulse, Modbus, etc.
- Rechargeable lithium ion batteries for > 4 hours control station operation depending on the external sensors
- 3.5" transmissive TFT touch panel, graphics, curves, statistics
- Integrated data logger
- Integrated USB interface
- Up to 8 languages available for selection
- Graphical and/or tabular reports
- Power supply for sensors: Output voltage 24 VDC \pm 10%, output current 120 mA in continuous operation
- Dimensions: 82 x 96 x 245 mm
- Weight: 450 g
- Housing material: PC/ABS
- Working temperature: 0 °C to +50 °C
- Memory space: 4 GB – standard memory card



DL 200

Portable hand-held measurement unit with integrated data logger

Art. No.	Type No.
135978	DL 200

→ Also suitable for differential pressure flow meter on page 143

Accessories for hand-held measurement unit

Art. No.	Type No.	Description
135866	DL200-AL5	Cable for connection of the flowmeter
135867	DL200-AL5-F	Cable for connection of external sensors
135868	DL200-TK	Transport case for hand-held measurement unit
135964	DL200-ASW	Software for evaluation hand-held unit (max. 2 licenses)



DL200-AL5



DL200-TK

Flowmeter

MAX

Calorimetric measurement system for monitoring changes in flow and consumption as well as for leak and energy efficiency measurements. No additional pressure or temperature compensation is necessary.

All measured values are recorded digitally, making very rapid, high-precision measurement possible.

High measurement accuracy due to defined measurement section.

- Display: Current consumption in l/min, m³/hr, etc. and total consumption (meter reading) in m³, l, etc.
- Total consumption (meter reading) can be reset to "zero" with keypad
- Display can pivot 180°, measuring device can be unscrewed
- Measured quantities: m³/hr, l/min (1000 mbar, 20 °C) for compressed air or Nm³/h, NI/min (1013 mbar, 0 °C) for gases
- Units: m³/hr, m³/min, l/min, etc. can be selected with keypad
- Gas types: Compressed air (= standard), other gas types such as nitrogen, argon, CO₂, etc. can be selected with hand-held measurement unit
- Accuracy: ± 1.5% of measured value
- Digital output: RS 485 interface, Modbus RTU for connecting to energy management systems, building management systems, etc.
- Housing material: Polycarbonate (IP65)
- Measurement section material: Stainless steel 1.4301

Not included in delivery:

- Wall power supply
- Portable hand-held measurement unit with mobile data logger

Measuring system	Calorimetric measurement
Medium	Compressed air, neutral gases
Max. operating pressure	16 bar
Temperature range	-30 to 80 °C
Flow rate output	Analogue 4 to 20 mA, pulse output (galvanically separated)
Operating voltage	24 V DC
Display	Background lighting

Flowmeter incl. measurement section with threaded connection

Art. No.	Type No.	Measuring range	Thread	DN	L mm	H1 mm	Tube I.D. mm
135870	DFMM08-14	0.8 l/min to 90 l/min	R 1/4	8	194.0	165.7	8.9
135871	DFMM15-12	0.2 m ³ /h to 90 m ³ /h	R 1/2	15	300.0	165.7	16.1
135872	DFMM20-34	0.3 m ³ /h to 170 m ³ /h	R 3/4	20	475.0	165.7	21.7
135873	DFMM25-1	0.5 m ³ /h to 290 m ³ /h	R 1	25	475.0	165.7	27.3
135874	DFMM32-114	0.7 m ³ /h to 530 m ³ /h	R 1 1/4	32	475.0	165.7	36
135875	DFMM40-112	1.0 m ³ /h to 730 m ³ /h	R 1 1/2	40	475.0	165.7	41.9

Flowmeter incl. measurement section with flanged connection (DIN EN 1092-1)

Art. No.	Type No.	Measuring range	DN	L mm	H1 mm	Tube I.D. mm	Flange- Ø D mm	Pitch circle Ø K mm	No. of bolt holes
135877	DFMM15-FL15	0.2 m ³ /h to 90 m ³ /h	15	300.0	165.7	16.1	95	65	4 x 14
135878	DFMM20-FL20	0.3 m ³ /h to 170 m ³ /h	20	475.0	165.7	21.7	105	75	4 x 14
135879	DFMM25-FL25	0.5 m ³ /h to 290 m ³ /h	25	475.0	165.7	27.3	115	85	4 x 14
135880	DFMM32-FL32	0.7 m ³ /h to 530 m ³ /h	32	475.0	165.7	36	140	100	4 x 18

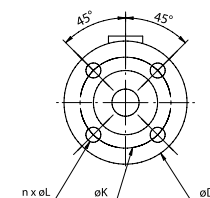
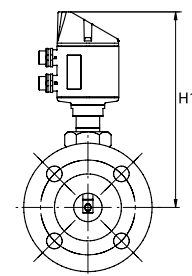
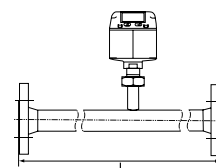
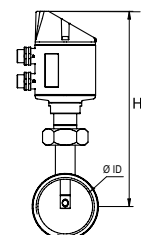
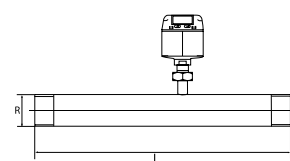

1

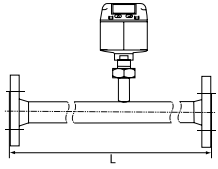

Flowmeter

MAX II
Flowmeter incl. measurement section with flanged connection (DIN EN 1092-1)

Art. No.	Type No.	Measuring range	DN	L mm	H1 mm	Tube I.D. mm	Flange- Ø D mm	Pitch circle Ø K mm	No. of bolt holes
135881	DFMM40-FL40	1.0 m ³ /h to 730 m ³ /h	40	475.0	165.7	41.9	150	110	4 x 18
135882	DFMM50-FL50	2.0 m ³ /h to 1195 m ³ /h	50	475.0	165.7	53.1	165	125	4 x 18

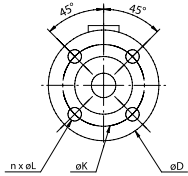
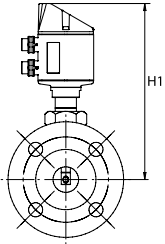

SNT-230/24

Accessories for Flowmeter

Art. No.	Type No.	Description
135865	SNT-230/24	Wall power supply 100-240 V AC / 24 V DC, 5-pole, M12x1

NEW Leak detector LS 250

ultrasonic measuring technology

PLUS

PRINCIPLE:

High and avoidable energy costs are caused every year by leaks in compressed air and gas installations.

Noise in the ultrasonic range is caused by gases escaping from leaks. These ultrasonic sounds are not audible to the human ear.

The LS 250 leak detector picks up even smallest leaks from a distance of several metres. How? It transformst he inaudible ultrasonic sounds into a frequency that can be detected visually on the display and acoustically with the aid oft he soundproof headphones.

The LS 250 is the further development of the proven LS 200. Like the LS 200, it convinces with a fine sensor technology that effectively improves the detection of leaks. The integrated laser pointer is used for target bearing. This allows leaks to be localised precisely. In addition to the advantages of the LS 200, the LS 250 also has a large touch display.

The specially designed bell achieves a better bundling of the sound waves. This horn acts like a directional microphone. Disturbing backgrounds noises, for example those that occur during operation, are suppressed or faded out. This makes it easier to locate leaks even in areas that are difficult to access.

APPLICATIONS:

Leak detection in compressed air, gas, steam and vacuum systems. Not suitable for helium.

ADVANTAGES:

- Simple and fast measurement - even from a distance of several meters.
- Measurements can be carried out during operation without impairing it.
- Short payback time oft he device due to high cost savings.
- Loud background noise does not affect the quality oft he measurements in any way, since the acoustic frequency works in the ultrasonic range.
- Safe and easy handling.

CONNECTION:

- Mains adapter socket for external charging unit
- 3.5-mm jack plug for headphones

SCOPE OF DELIVERY IN A PRACTICAL SUITCASE SET:

- Leak detector with ultrasonic sensor
- Acoustic trumpet
- Focus tube with focus tip
- Soundproof, ergonomic headphones
- Power supply unit/charger
- Carrying case



LS 250

Working frequency	40 kHz ± 2 kHz
Laser as an visual tools	Wave length: 630...660 nm, Output power: <1 mW
Power supply	Lithium-ion battery with high capacity, external recharger
Operating time	> 10 hours
Charging time	max. 4 hours Stunden
Operating temperature	-5 to 50 °C
Storage temperature	-20 to 60 °C

Leak detector

Art. No.	Type No.	Description
206419	LS 250	Leak detection LS250 device incl. accessories in a carrying case

1

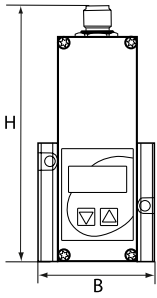

Proportional control valves

»sentronic LP« Type



Proportional valve for simple and efficient pressure regulation.

With low space requirement, simple operation, modular design and modern software (see Downloads), the valve offers many options for optimising your processes.

Digital communication and control technology.
 Low power consumption < 4 W through servo-assisted pilot valves.
 Other functions are diagnostics, parameterisation and service.
 Servo-assisted proportional valve, conforms to RoHS, REACH.

The target value is preset via the electrical plug connection as a standard signal (0 - 10 V).

Medium	Air or neutral gases, filter.50 µm, lubricat. or unlubricat.
Working pressure	0 - 10 bar
Operation	3-way valves
Piloting	0 - 10 V
Medium temperature	0 to 60 °C
Ambient temperature	0 to 50 °C
DN	4
Electrical setpoint	0 - 10 V
Failsafe behaviour	Maintenance of press. in case of loss of voltage-non control
Reproducibility	1% FS
Hysteresis	1% FS
Housing	Aluminium
Internal parts	POM
Sealant	NBR
Flow rate	470 l/min
Flow rate measurement	At P ₂ = 6 bar



PV 2160-N

Proportional control valve, 3-way type, with control loop, 24 V DC

Art. No.	Type No.	Thread	B mm	H mm
135885	PV 2160-N	G 1/4	52.0	115.0

➔ Proportional control valve with piloting 0 - 20 mA or 4 - 20 mA available on request

Accessories for proportional control valve



Art. No.	Type No.	Description
101635	PVZ 10	M12 angle cable socket, 5-pin, with screw terminals
101637	PVZ 12	RS 232 converter, 2 m cable with 9-pole sub-D plug

Proportional control valves

»sentronic D« Type



For electronic pressure control.

Highly dynamic, 3-way proportional valve with digital control.

D stands for:

- Digital communication and control
- Display (integrated)
- Directly operated
- Dynamic (high-speed)

A special feature is the DaS software (see "Downloads") that provides optimum controller adjustment over a PC (RS 232 interface). This software additionally allows the setpoint and actual value to be visualised. Other functions are valve diagnostics, parameter setting and maintenance. The valve's outlet pressure can also be adjusted using the integrated display and the function buttons, and the valve can optionally be operated without a PC.

Benefits:

- Minimum hysteresis
- Extremely short response times
- Extremely low sensitivity
- No constant air consumption
- Analogue actual value output
- Digital control
- High speed
- Communication with a PC

Medium	Air or neutral gases ($\leq 50 \mu\text{m}$ filter specified)
Working pressure	0 - 10 bar
Operation	Proportional solenoid valve
Piloting	0 - 10 V
Medium temperature	0 to 60 °C
Ambient temperature	0 to 50 °C
Electrical setpoint	0 - 10 V
Analogue output	0 - 10 V
Digital output	Pressure switch output PNP +/- 5%
Failsafe behaviour	Pressure relieved in case of loss of voltage
Housing	Aluminium
Internal parts	POM
Sealant	NBR

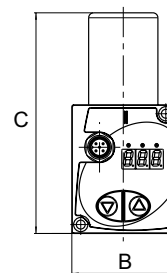

Proportional control valve, digital, 24 V DC

Art. No.	Type No.	Thread	DN	Flow rate l/min	B mm	C mm
101631	PV 2250	G 1/8	4	780	52.0	112.0
101632	PV 2251	G 1/4	4	780	52.0	112.0
101633	PV 2260	G 1/4	8	1750	66.0	138.0
101634	PV 2261	G 3/8	8	1750	66.0	138.0

➔ Proportional control valve with piloting 0 - 20 mA or 4 - 20 mA available on request



PV 2251

Accessories for proportional control valve, digital

Art. No.	Type No.	Description
101635	PVZ 10	M12 angle cable socket, 5-pin, with screw terminals
101636	PVZ 11	Power supply cable 2 m, 5 x 0.25 mm ²
101637	PVZ 12	RS 232 converter, 2 m cable with 9-pole sub-D plug



PVZ 10

PVZ 12



PVZ 11

1

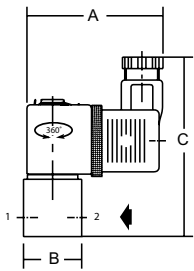
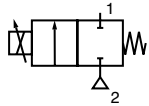

Proportional control valves

»posiflow« type



For electronic flow control.

For all applications where the flow rate of a liquid or gas has to be controlled. The valve features a special magnet armature and is characterised by low friction and a high dynamic response.

If the valve is combined with a plug amplifier:
 The maximum / minimum current and frequency can be adjusted by means of integrated potentiometers. A current ramp can also be connected and adjusted with a potentiometer. This facilitates a slow change in the flow rate, even if the setpoint changes suddenly. If the setpoint is < 200 mV (< 0.4 / 4.4 mA), the piloting current is completely switched off, causing the valve to be de-energised (tightly closed function).

We recommend combining these proportional valves with a plug amplifier.

Benefits:

- Compact and economical
- Integrated temperature compensation
- Precise control
- Optimised flow with no water hammer
- Ramp function assures a smooth response to step changes in the input signal
- Disconnect function

Medium	Air, neutral gases, water, oil
Pressure range	Vacuum to 8 bar
Sealant	FKM
Piloting	Via plug amplifier 0 to 10 V, 0 to 20 mA, 4 to 20 mA
Valve disc	FKM
Housing	Brass
Valve seat	Brass
Internal parts	Stainless steel
Failsafe behaviour	Tight closure in case of loss of voltage

Proportional valve for controlling the flow of air / gas / water / oil, 24 VDC, closed when de-energised

Art. No.	Type No.	Thread	Medium temperature °C	Ambient temperature °C	DN	Max. operating pressure difference bar	A mm	B mm	C mm
101639	PV 2011	G 1/8	0 to 50	0 to 40	1.2	5	59.0	25.0	78.0
101640	PV 2012	G 1/8	0 to 50	0 to 40	1.6	4	59.0	25.0	78.0



PV 2011

Proportional valve for controlling the flow of air / gas, 24 VDC, closed when de-energised

Art. No.	Type No.	Thread	Medium temperature °C	Ambient temperature °C	DN	Max. operating pressure difference bar	A mm	B mm	C mm
101641	PV 2013	G 1/4	-10 to 90	-10 to 75	2.4	8	85.0	40.0	95.0
101642	PV 2014	G 1/4	-10 to 90	-10 to 75	3.2	4	85.0	40.0	95.0
101643	PV 2015	G 3/8	-10 to 90	-10 to 75	5.6	1.4	85.0	48.0	97.0
101644	PV 2016	G 3/8	-10 to 90	-10 to 75	7.1	1	85.0	48.0	97.0



PV 2013

Proportional valve for controlling the flow of water / oil, 24 VDC, closed when de-energised

Art. No.	Type No.	Thread	Medium temperature °C	Ambient temperature °C	DN	Max. operating pressure difference bar	A mm	B mm	C mm
101645	PV 2023	G 1/4	-10 to 90	-10 to 75	2.4	8	85.0	40.0	95.0
101646	PV 2024	G 1/4	-10 to 90	-10 to 75	3.2	4	85.0	40.0	95.0
101647	PV 2025	G 3/8	-10 to 90	-10 to 75	5.6	1.4	85.0	48.0	97.0
101648	PV 2026	G 3/8	-10 to 90	-10 to 75	7.1	1	85.0	48.0	97.0

Plug amplifier / chopper amplifier

for »posiflow« proportional control valves



For converting the 0 to 10 V, 0 to 20 mA or 4 to 20 mA standard signal (settable) to an impressed current (0 to 1 A). The impressed current is pulse width modulated to ensure low-hysteresis, thermally stable control.

With settable time ramp (ON/OFF, 0.1 to 3 s).

The minimum and maximum supply current for the solenoid can be set according to the control signals.



Operating voltage	24 V DC
Housing	PA

Plug amplifier (mounting directly on the valve)

Art. No.	Type No.	Temperature range °C	For types
101649	PV 2910	-10 to 75	G 1/8
101650	PV 2920	-10 to 75	G 1/4, G 3/8



PV 2910

Chopper amplifier (cabinet mounting)

Art. No.	Type No.	Temperature range °C
101651	PV 2930	-10 to 60



PV 2930

1

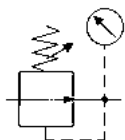

Stainless steel pressure regulators

made of stainless steel 1.4571

Diaphragm pressure regulators with non-self-relieving design.
The pressure setting can be locked by pushing the knob down.

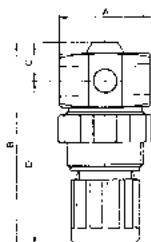

Max. input pressure	25 bar
Max. medium temperature	80 °C
Max. ambient temperature	80 °C
Housing	Stainless steel V4A (1.4571)
Internal parts	Stainless steel V4A (1.4571)
Sealant	FKM
Diaphragms	FKM
Flow rate measurement	At $P_1 = 8$ bar, $P_2 = 6$ bar and pressure drop $\Delta p = 1$ bar



777.302

Stainless steel pressure regulator for liquid media without pressure gauge

Art. No.	Type No.	Thread	Pressure spring	Control range bar	Flow rate l/min	A mm	B mm	C mm	D mm
101185	777.301	G 1/4	Steel	0,1 - 2	320	36.0	81.0	16.0	65.0
101186	777.302	G 1/4	Steel	0,2 - 6	320	36.0	81.0	16.0	65.0
101187	777.303	G 1/4	Stainless steel	0,5 - 10	320	36.0	81.0	16.0	65.0

Accessories / spare parts



MV 30

110.46-ES

Art. No.	Type No.	Description
100344	MV 30	Mounting bracket with nut M30x1.5
101188	110.46-ES	Pressure gauge Ø 40 mm, G 1/8 ET, 0 - 10 bar
101189	110.43-ES	Pressure gauge Ø 40 mm, G 1/8 ET, 0 - 2.5 bar
101190	22.777.4	Set of wearing parts

Stainless steel pressure regulators

made of stainless steel 1.4404

Stainless steel regulators containing no non-ferrous metals for use in the food processing, chemical, mining, plant construction and special machinery industries as well as in the medical technology.

Max. medium temperature	80 °C
Max. ambient temperature	80 °C
Housing	Stainless steel 1.4404 (AISI 316L)
Sealant	FKM
Flow rate measurement	At $P_1 = 8 \text{ bar}$, $P_2 = 6 \text{ bar}$ and pressure drop $\Delta p \leq 1 \text{ bar}$

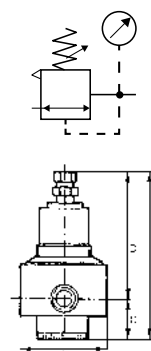

Reversible, stainless steel pressure regulator with self-relieving design, stainless steel pressure gauge

Art. No.	Type No.	Thread	Max. input pressure bar	Diaphragms	Control range bar	Flow rate l/min	A mm	B mm	D mm
101191	570.14 B	G 1/4	30	PTFE on NBR carrier	0,5 - 8	1300	64.0	160.0	122.0
101192	570.14 D	G 1/4	50	PTFE on NBR carrier	1 - 15	1300	64.0	160.0	122.0
129270	DRES.G12R.05-8B	G 1/2	50	PTFE on NBR carrier	0,5 - 8	2800	109.0	160.0	121.0
129271	DRES.G12R.1-15B	G 1/2	50	PTFE on NBR carrier	1 - 15	2800	109.0	160.0	121.0



570.14 B

Non-reversible, stainless steel pressure regulator, for liquid media, without self-relieving design, stainless steel pressure gauge

Art. No.	Type No.	Thread	Max. input pressure bar	Diaphragms	Control range bar	Flow rate l/min	A mm	B mm	D mm
101195	571.14 B	G 1/4	30	PTFE on NBR-carrier	0,5 - 8	1300	64.0	160.0	122.0
101196	571.14 D	G 1/4	50	PTFE on NBR-carrier	1 - 15	1300	64.0	160.0	122.0
129272	DRES.G12NR.05-8B	G 1/2	50	PTFE on NBR carrier	0,5 - 8	2800	109.0	160.0	121.0
129273	DRES.G12NR.1-15B	G 1/2	50	PTFE on NBR carrier	1 - 15	2800	109.0	160.0	121.0



DRES.G12R.05-8B

- ➔ NPT thread available on request
- ➔ Other control ranges, temperature ranges and FDA approval available on request

Accessories / spare parts

Art. No.	Type No.	Description
101199	576/1	Mounting bracket with nut M45x1.5
101200	576/3	Mounting bracket with nut M50x1.5
101201	4084	Pressure gauge Ø 63 mm, G 1/4 ET, 0 - 10 bar
101202	4085	Pressure gauge Ø 63 mm, G 1/4 ET, 0 - 16 bar
101203	22.5704.4	Set of wearing parts for G 1/4 (reversible), max. 30 bar
194360	VTSDR14R50	Set of wearing parts for G 1/4 (reversible), max. 50 bar
129671	VTSDRES.G12.RÜ	Wear part set for G 1/2 (reversible)
101205	22.5714.4.16	Set of wearing parts for G 1/4 (non-reversible), max. 30 bar
194362	VTSDR1450	Set of wearing parts for G 1/4 (non-reversible), max. 50 bar
129672	VTSDRES.G12	Wear part set for G 1/2 (non-reversible)



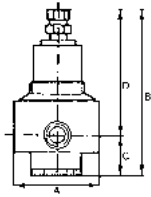
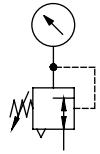

Stainless steel pressure regulators

made of stainless steel 1.4401

Stainless steel regulators for use in the chemical industry, mining, plant construction and special machinery industries, pneumatics, etc.
Pressure setting by hexagon head screw.

Max. input pressure	30 bar
Max. medium temperature	80 °C
Max. ambient temperature	80 °C
Housing	Stainless steel 1.4401 (AISI 316)
Sealant	NBR
Diaphragms	NBR/PTFE
Flow rate measurement	At $P_1 = 10$ bar, $P_2 = 6$ bar and pressure drop $\Delta p \leq 1$ bar



580RM3-12-4

Reversible, stainless steel pressure regulator with self-relieving design and stainless steel pressure gauge

Art. No.	Type No.	Thread	Control range bar	Flow rate l/min	A mm	B mm	C mm	D mm
133525	580RM1-14-4	G 1/4	0,4 - 4	2320	64.0	167.0	50.0	117.0
133526	580RM1-14-17	G 1/4	1,7 - 17,5	2320	64.0	167.0	50.0	117.0
133527	580RM1-38-4	G 3/8	0,4 - 4	4900	64.0	167.0	50.0	117.0
133528	580RM1-38-17	G 3/8	1,7 - 17,5	4900	64.0	167.0	50.0	117.0
133529	580RM3-12-4	G 1/2	0,4 - 4	6175	82.0	169.0	50.0	119.0
133530	580RM3-12-17	G 1/2	1,7 - 17,5	6175	82.0	169.0	50.0	119.0
133531	580RM3-34-4	G 3/4	0,4 - 4	10195	82.0	169.0	50.0	119.0
133532	580RM3-34-17	G 3/4	1,7 - 17,5	10195	82.0	169.0	50.0	119.0
133533	580RM4-1-4	G 1	0,4 - 4	10195	120.0	236.0	100.0	136.0
133534	580RM4-1-17	G 1	1,7 - 17,5	10195	120.0	236.0	100.0	136.0

➔ Other control ranges available on request.



580RM-BW



4083

Accessories / spare parts for stainless steel pressure regulator G 1/4 and G 3/8 (Size 1)

Art. No.	Type No.	Description
137113	580RM-BW	Mounting bracket
102510	4083	Pressure gauge Ø 63 mm, G 1/4 ET, 0 - 6 bar
102511	4086	Pressure gauge Ø 63 mm, G 1/4 ET, 0 - 25 bar
137114	580RM1-VS	Set of wearing parts

Accessories / spare parts for stainless steel pressure regulator G 1/2 and G 3/4 (Size 3)

Art. No.	Type No.	Description
137113	580RM-BW	Mounting bracket
102510	4083	Pressure gauge Ø 63 mm, G 1/4 ET, 0 - 6 bar
102511	4086	Pressure gauge Ø 63 mm, G 1/4 ET, 0 - 25 bar
137115	580RM3-VS	Set of wearing parts



580RM3-VS

Accessories / spare parts for stainless steel pressure regulator G 1 (Size 4)

Art. No.	Type No.	Description
137113	580RM-BW	Mounting bracket
102510	4083	Pressure gauge Ø 63 mm, G 1/4 ET, 0 - 6 bar
102511	4086	Pressure gauge Ø 63 mm, G 1/4 ET, 0 - 25 bar
137116	580RM4-VS	Set of wearing parts

Stainless steel pressure regulators

made of stainless steel casting 1.4401

Stainless steel regulators for use in the chemical industry, mining, plant construction and special machinery industries, pneumatics, etc.

Pressure setting by T-handle.

Max. input pressure	30 bar
Max. medium temperature	80 °C
Max. ambient temperature	80 °C
Housing	Stainless steel casting 1.4401 (AISI 316)
Sealant	NBR
Diaphragms	NBR/PTFE
Flow rate measurement	At $P_1 = 10$ bar, $P_2 = 6$ bar and pressure drop $\Delta p \leq 1$ bar

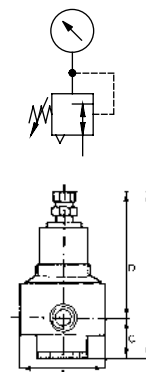

Reversible, stainless steel pressure regulator with self-relieving design and stainless steel pressure gauge

Art. No.	Type No.	Thread	Control range bar	Flow rate l/min	A mm	B mm	C mm	D mm
137323	580RC1-14-4	G 1/4	0,4 - 4	2125	62.0	166.0	51.0	115.0
137324	580RC1-14-17	G 1/4	1,7 - 17,5	2125	62.0	166.0	51.0	115.0
137325	580RC1-38-4	G 3/8	0,4 - 4	3965	62.0	166.0	51.0	115.0
137326	580RC1-38-17	G 3/8	1,7 - 17,5	3965	62.0	166.0	51.0	115.0
137327	580RC3-12-4	G 1/2	0,4 - 4	8070	82.0	170.0	49.0	121.0
137328	580RC3-12-17	G 1/2	1,7 - 17,5	8070	82.0	170.0	49.0	121.0
137329	580RC3-34-4	G 3/4	0,4 - 4	9260	82.0	170.0	49.0	121.0
137330	580RC3-34-17	G 3/4	1,7 - 17,5	9260	82.0	170.0	49.0	121.0
137331	580RC4-1-4	G 1	0,4 - 4	10790	120.0	224.0	88.0	136.0
137332	580RC4-1-17	G 1	1,7 - 17,5	10790	120.0	224.0	88.0	136.0
137333	580RC4-112-4	G 1 1/2	0,4 - 4	11270	120.0	224.0	88.0	136.0
137334	580RC4-112-17	G 1 1/2	1,7 - 17,5	11270	120.0	224.0	88.0	136.0



580RC3-12-4

→ Other control ranges available on request.

Accessories / spare parts for stainless steel pressure regulator G 1/4 and G 3/8 (Size 1)

Art. No.	Type No.	Description
137113	580RM-BW	Mounting bracket
102510	4083	Pressure gauge Ø 63 mm, G 1/4 ET, 0 - 6 bar
102511	4086	Pressure gauge Ø 63 mm, G 1/4 ET, 0 - 25 bar
137316	580RC1-VS	Set of wearing parts



580RM-BW

4083

Accessories / spare parts for stainless steel pressure regulator G 1/2 and G 3/4 (Size 3)

Art. No.	Type No.	Description
137113	580RM-BW	Mounting bracket
102510	4083	Pressure gauge Ø 63 mm, G 1/4 ET, 0 - 6 bar
102511	4086	Pressure gauge Ø 63 mm, G 1/4 ET, 0 - 25 bar
137317	580RC3-VS	Set of wearing parts



580RM3-VS

Accessories / spare parts for stainless steel pressure regulator G 1 and G 1 1/2 (Size 4)

Art. No.	Type No.	Description
137113	580RM-BW	Mounting bracket
102510	4083	Pressure gauge Ø 63 mm, G 1/4 ET, 0 - 6 bar
102511	4086	Pressure gauge Ø 63 mm, G 1/4 ET, 0 - 25 bar
137318	580RC4-VS	Set of wearing parts

1

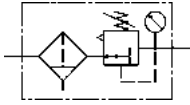

Stainless steel filter regulators

made of stainless steel 1.4404

Stainless steel filter regulators with self-relieving (not for liquid media) containing no non-ferrous metals for use in the food processing, chemical, mining, plant construction and special machinery industries as well as in the medical technology.

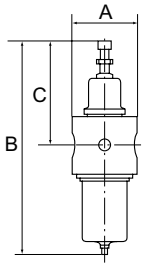

Max. input pressure	30 bar
Max. medium temperature	80 °C
Max. ambient temperature	80 °C
Control range	1 - 15 bar
Housing	Stainless steel 1.4404 (AISI 316L)
Sealant	FKM
Diaphragms	PTFE on NBR-carrier
Condensate drain	Manual drain valve
Filter rating	50 µm
Flow rate measurement	At $P_1 = 8 \text{ bar}$, $P_2 = 6 \text{ bar}$ and pressure drop $\Delta p \leq 1 \text{ bar}$



572.14 D



FRES.G12R.1-15B

Reversible, stainless steel pressure regulator with self-relieving design, manual drain valve and stainless steel pressure gauge

Art. No.	Type No.	Thread	Flow rate l/min	A mm	B mm	C mm
101207	572.14 D	G 1/4	800	64.0	249.0	121.0
129274	FRES.G12R.1-15B	G 1/2	3000	109.0	246.0	121.0

- ➔ With filter element 5 µm available on request
- ➔ Without self-relieving design (for liquids) available on request
- ➔ With semi- or fully automatic drain valve on request
- ➔ Other control ranges, temperature ranges and FDA-approval available on request



576/1

576/3



4084

22.57244.4

Accessories / spare parts

Art. No.	Type No.	Description
101199	576/1	Mounting bracket with nut M45x1.5
101200	576/3	Mounting bracket with nut M50x1.5
101201	4084	Pressure gauge Ø 63 mm, G 1/4 ET, 0 - 10 bar
101202	4085	Pressure gauge Ø 63 mm, G 1/4 ET, 0 - 16 bar
101209	22.57244.4	Set of wearing parts for G 1/4
129673	VTSFRES.G12.RÜ	Wear part set for G 1/2

Stainless steel filter regulators

made of stainless steel 1.4401

Stainless steel filter regulators with self-relieving (not for liquid media) for use in the chemical industry, mining, plant construction and special machinery industries, pneumatics, etc.
Pressure setting by hexagon head screw.

Max. input pressure	30 bar
Max. medium temperature	80 °C
Max. ambient temperature	60 °C
Housing	Stainless steel 1.4401 (AISI 316)
Sealant	NBR
Diaphragms	NBR/PTFE
Condensate drain	Manual drain valve
Filter rating	25 µm
Flow rate measurement	At $P_1 = 10$ bar, $P_2 = 6$ bar and pressure drop $\Delta p \leq 1$ bar

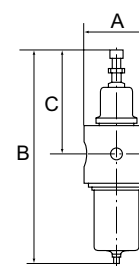
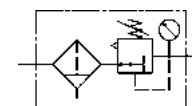

Reversible, stainless steel filter regulator with self-relieving design, manual drain valve and stainless steel pressure gauge

Art. No.	Type No.	Thread	Control range bar	Flow rate l/min	A mm	B mm	C mm
133539	580FRM1-14-4	G 1/4	0,4 - 4	2495	64.0	271.0	117.0
133540	580FRM1-14-17	G 1/4	1,7 - 17,5	2495	64.0	271.0	117.0
133541	580FRM1-38-4	G 3/8	0,4 - 4	3200	64.0	271.0	117.0
133542	580FRM1-38-17	G 3/8	1,7 - 17,5	3200	64.0	271.0	117.0
133543	580FRM3-12-4	G 1/2	0,4 - 4	5440	82.0	275.0	123.0
133544	580FRM3-12-17	G 1/2	1,7 - 17,5	5440	82.0	275.0	123.0
133545	580FRM3-34-4	G 3/4	0,4 - 4	9630	82.0	275.0	123.0
133546	580FRM3-34-17	G 3/4	1,7 - 17,5	9630	82.0	275.0	123.0
133547	580FRM4-1-4	G 1	0,4 - 4	10000	120.0	346.0	136.0
133548	580FRM4-1-17	G 1	1,7 - 17,5	10000	120.0	346.0	136.0



580FRM3-12-4

➔ Other control ranges available on request.

Accessories / spare parts for stainless steel filter regulator G 1/4 and G 3/8 (Size 1)

Art. No.	Type No.	Description
137113	580RM-BW	Mounting bracket
137117	580FM-BMA	Stainless steel container
102510	4083	Pressure gauge Ø 63 mm, G 1/4 ET, 0 - 6 bar
102511	4086	Pressure gauge Ø 63 mm, G 1/4 ET, 0 - 25 bar
137114	580RM1-VS	Set of wearing parts
137119	580FM-EF	Replacement filter element
137121	580FM1-ED	Replacement seal



580RM-BW



580FM-BMA



4083



580RM3-VS

Accessories / spare parts for stainless steel filter regulator G 1/2 and G 3/4 (Size 3)

Art. No.	Type No.	Description
137113	580RM-BW	Mounting bracket
137117	580FM-BMA	Stainless steel container
102510	4083	Pressure gauge Ø 63 mm, G 1/4 ET, 0 - 6 bar
102511	4086	Pressure gauge Ø 63 mm, G 1/4 ET, 0 - 25 bar
137115	580RM3-VS	Set of wearing parts
137119	580FM-EF	Replacement filter element
137122	580FM3-ED	Replacement seal



580FM-EF



580FM3-ED

Accessories / spare parts for stainless steel filter regulator G 1 (Size 4)

Art. No.	Type No.	Description
137113	580RM-BW	Mounting bracket
137118	580FM4-BMA	Stainless steel container
102510	4083	Pressure gauge Ø 63 mm, G 1/4 ET, 0 - 6 bar
102511	4086	Pressure gauge Ø 63 mm, G 1/4 ET, 0 - 25 bar
137116	580RM4-VS	Set of wearing parts
137120	580FM4-EF	Replacement filter element
137123	580FM4-ED	Replacement seal

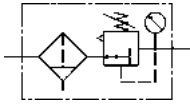

Stainless steel filter regulators

made of stainless steel casting 1.4401

Stainless steel filter regulators with self-relieving (not for liquid media) for use in the chemical industry, mining, plant construction and special machinery industries, pneumatics, etc. Pressure setting by T-handle.

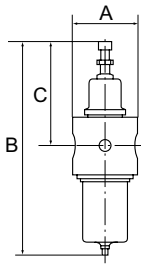

Max. input pressure	30 bar
Max. medium temperature	80 °C
Max. ambient temperature	60 °C
Housing	Stainless steel casting 1.4401 (AISI 316)
Sealant	NBR
Diaphragms	NBR/PTFE
Condensate drain	Manual drain valve
Filter rating	25 µm
Flow rate measurement	At $P_1 = 10$ bar, $P_2 = 6$ bar and pressure drop $\Delta p \leq 1$ bar



580FRC3-12-4

Reversible, stainless steel filter regulator with self-relieving design, manual drain valve and stainless steel pressure gauge

Art. No.	Type No.	Thread	Control range bar	Flow rate l/min	A mm	B mm	C mm
137335	580FRC1-14-4	G 1/4	0,4 - 4	2095	62.0	227.0	115.0
137336	580FRC1-14-17	G 1/4	1,7 - 17,5	2095	62.0	227.0	115.0
137337	580FRC1-38-4	G 3/8	0,4 - 4	4420	62.0	227.0	115.0
137338	580FRC1-38-17	G 3/8	1,7 - 17,5	4420	62.0	227.0	115.0
137339	580FRC3-12-4	G 1/2	0,4 - 4	7850	82.0	233.0	121.0
137340	580FRC3-12-17	G 1/2	1,7 - 17,5	7850	82.0	233.0	121.0
137341	580FRC3-34-4	G 3/4	0,4 - 4	10055	82.0	233.0	121.0
137342	580FRC3-34-17	G 3/4	1,7 - 17,5	10055	82.0	233.0	121.0
137343	580FRC4-1-4	G 1	0,4 - 4	11330	120.0	301.0	136.0
137344	580FRC4-1-17	G 1	1,7 - 17,5	11330	120.0	301.0	136.0
137345	580FRC4-112-4	G 1 1/2	0,4 - 4	11330	120.0	301.0	136.0
137346	580FRC4-112-17	G 1 1/2	1,7 - 17,5	11330	120.0	301.0	136.0

→ Other control ranges available on request.



580RM-BW 580FC-BMA



4083 580RC3-VS

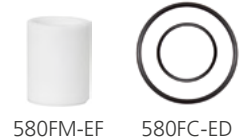

580FM-EF 580FC-ED

Accessories / spare parts for stainless steel filter regulator G 1/4 and G 3/8 (Size 1)

Art. No.	Type No.	Description
137113	580RM-BW	Mounting bracket
137319	580FC-BMA	Stainless steel container
102510	4083	Pressure gauge Ø 63 mm, G 1/4 ET, 0 - 6 bar
102511	4086	Pressure gauge Ø 63 mm, G 1/4 ET, 0 - 25 bar
137316	580RC1-VS	Set of wearing parts
137119	580FM-EF	Replacement filter element
137321	580FC-ED	Replacement seal

Accessories / spare parts for stainless steel filter regulator G 1/2 and G 3/4 (Size 3)

Art. No.	Type No.	Description
137113	580RM-BW	Mounting bracket
137319	580FC-BMA	Stainless steel container
102510	4083	Pressure gauge Ø 63 mm, G 1/4 ET, 0 - 6 bar
102511	4086	Pressure gauge Ø 63 mm, G 1/4 ET, 0 - 25 bar
137317	580RC3-VS	Set of wearing parts
137119	580FM-EF	Replacement filter element
137321	580FC-ED	Replacement seal

Accessories / spare parts for stainless steel filter regulator G 1 and G 1 1/2 (Size 4)

Art. No.	Type No.	Description
137113	580RM-BW	Mounting bracket
137320	580FC4-BMA	Stainless steel container
102510	4083	Pressure gauge Ø 63 mm, G 1/4 ET, 0 - 6 bar
102511	4086	Pressure gauge Ø 63 mm, G 1/4 ET, 0 - 25 bar
137318	580RC4-VS	Set of wearing parts
137120	580FM4-EF	Replacement filter element
137322	580FC4-ED	Replacement seal

Stainless steel filter

made of stainless steel 1.4404

Stainless steel filters containing no non-ferrous metals for use in the food processing, chemical, mining, plant construction and special machinery industries as well as in the medical technology.

Max. input pressure	50 bar
Max. medium temperature	80 °C
Max. ambient temperature	80 °C
Housing	Stainless steel 1.4404 (AISI 316L)
Sealant	FKM
Condensate drain	Locking screw
Filter rating	50 µm
Flow rate measurement	At $P_1 = 7$ bar and pressure drop $\Delta p \leq 0.33$ bar

Stainless steel filter

Art. No.	Type No.	Thread	Flow rate l/min	A mm	B mm	C mm
101211	572.14	G 1/4	900	64.0	140.0	125.0
129670	FES.G1250	G 1/2	2500	109.0	140.0	123.0

- With filter element 5 µm available on request
- With manual or fully automatic drain valve on request
- With NPT threads available on request
- Important: This is not a sterile filter!
- Other control ranges, temperature ranges and FDA approval available on request

Accessories / spare parts

Art. No.	Type No.	Description
101215	576/5	Mounting bracket, stainless steel 1.4401 for G 1/4
101216	576/6	Mounting bracket, stainless steel 1.4401 for G 1/2
101213	22.5724.4	Set of wearing parts for G 1/4
129674	VTSFES.G12	Wear part set for G 1/2

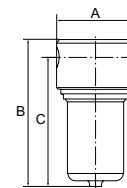
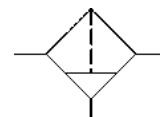

572.14



FES.G1250



22.5724.4

1

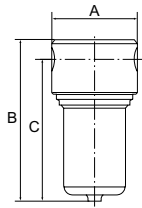
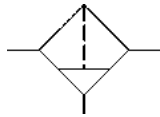

Stainless steel filter

made of stainless steel 1.4401

Stainless steel filters for use in the chemical industry, mining, plant construction and special machinery industries, pneumatics, etc.

Max. input pressure	30 bar
Max. medium temperature	80 °C
Max. ambient temperature	60 °C
Housing	Stainless steel 1.4401 (AISI 316)
Sealant	NBR
Condensate drain	Locking screw
Filter rating	25 µm
Flow rate measurement	At $P_1 = 6$ bar and pressure drop $\Delta p \leq 1$ bar



580FM3-12

Stainless steel filter

Art. No.	Type No.	Thread	Flow rate l/min	A mm	B mm	C mm
133549	580FM1-14	G 1/4	2155	64.0	169.0	152.0
133550	580FM1-38	G 3/8	2380	64.0	169.0	152.0
133551	580FM3-12	G 1/2	3485	82.0	170.0	155.0
133552	580FM3-34	G 3/4	5440	82.0	170.0	155.0
133553	580FM4-1	G 1	9960	120.0	190.0	160.0

- ➔ With filter element 5 µm available on request
- ➔ Important: This is not a sterile filter!

Accessories / spare parts for stainless steel filter G 1/4 and G 3/8 (Size 1)

Art. No.	Type No.	Description
137117	580FM-BMA	Stainless steel container
137119	580FM-EF	Replacement filter element
137121	580FM1-ED	Replacement seal

Accessories / spare parts for stainless steel filter G 1/2 and G 3/4 (Size 3)

Art. No.	Type No.	Description
137117	580FM-BMA	Stainless steel container
137119	580FM-EF	Replacement filter element
137122	580FM3-ED	Replacement seal

Accessories / spare parts for stainless steel filter G 1 (Size 4)

Art. No.	Type No.	Description
137118	580FM4-BMA	Stainless steel container
137120	580FM4-EF	Replacement filter element
137123	580FM4-ED	Replacement seal



Stainless steel filter

made of stainless steel casting 1.4401

Stainless steel filters for use in the chemical industry, mining, plant construction and special machinery industries, pneumatics, etc.

Max. input pressure	30 bar
Max. medium temperature	80 °C
Max. ambient temperature	60 °C
Housing	Stainless steel casting 1.4401 (AISI 316)
Sealant	NBR
Condensate drain	Locking screw
Filter rating	25 µm
Flow rate measurement	At $P_1 = 6$ bar and pressure drop $\Delta p \leq 1$ bar

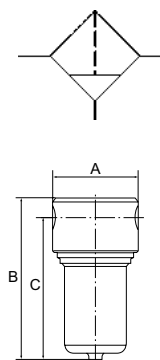

Stainless steel filter

Art. No.	Type No.	Thread	Flow rate l/min	A mm	B mm	C mm
137347	580FC1-14	G 1/4	2010	64.0	127.0	113.0
137348	580FC1-38	G 3/8	2920	64.0	127.0	113.0
137349	580FC3-12	G 1/2	5355	82.0	133.0	113.0
137350	580FC3-34	G 3/4	6855	82.0	133.0	113.0
137351	580FC4-1	G 1	9910	120.0	198.0	165.0
137352	580FC4-112	G 1 1/2	9910	120.0	198.0	165.0



580FC3-12

- ➔ With filter element 5 µm available on request
- ➔ Important: This is not a sterile filter!

Accessories / spare parts for stainless steel filter G 1/4 and G 3/8 (Size 1)

Art. No.	Type No.	Description
137319	580FC-BMA	Stainless steel container
137119	580FM-EF	Replacement filter element
137321	580FC-ED	Replacement seal



580FC-BMA



580FM-EF

Accessories / spare parts for stainless steel filter G 1/2 and G 3/4 (Size 3)

Art. No.	Type No.	Description
137319	580FC-BMA	Stainless steel container
137119	580FM-EF	Replacement filter element
137321	580FC-ED	Replacement seal



580FC-ED

Accessories / spare parts for stainless steel filter G 1 and G 1 1/2 (Size 4)

Art. No.	Type No.	Description
137320	580FC4-BMA	Stainless steel container
137120	580FM4-EF	Replacement filter element
137322	580FC4-ED	Replacement seal



FOR EVERY-

THING WHOSE

DEVIATIONS

ARE ON THE

POINTERS

Standard pressure gauges

 Plastic housing and dual scale in bar/psi 40, 50, 63 mm Page 204

 Plastic housing and single scale in bar 40, 50, 63 mm Page 205-207

 Sheet steel housing and single scale in bar 40, 50, 63 mm Page 207-209

 Panel-mounting type with sheet steel housing 40, 50, 63 mm Page 210-212

 Plastic or sheet steel housing and single scale in bar 80, 100, 160 mm Page 212-214

Glycerine pressure gauges

 Plastic housing and dual scale in bar/psi 63 mm Page 215-216

 Stainless steel housing and single scale in bar 63, 100 mm Page 216-217

 Metal housing and single scale in bar 63, 100 mm Page 217-219

 Panel-mounting type and single scale in bar 63, 100 mm Page 220-221

Pressure gauges robust type / for welding

 Pressure gauges robust type 100, 160 mm Page 222-223

Pressure gauges robust type / for welding

 Pressure gauges for welding applications Page 223

Capsule pressure gauge

 Capsule-type pressure gauge, Medium temperature max. 60 °C Page 224-225

 Capsule-type pressure gauges, Medium temperature max. 100 °C Page 226-227

Micrometre pressure gauge

 Precision pressure gauge, Medium temperature max. 60 °C Page 228

 Precision pressure gauges, Medium temperature max. 80 °C Page 229

Differential pressure gauge

 Differential pressure gauges – parallel male connector Page 230

 Differential pressure gauges with parallel male connector Page 230

Contact pressure gauge

 Contact pressure gauges Page 231

Diaphragm pressure gauge

 Diaphragm pressure gauges Page 232

Stainless steel pressure gauges

 Dual scale in bar/psi 40, 50 mm Page 233-234

 Single scale in bar 63, 100, 160 mm Page 234-235

 Safety housing and single scale in bar 63, 100 mm Page 236

 Stainless steel housing and single scale in bar 63, 100, 160 mm Page 237-239

 Stainless steel safety housing and single scale in bar 63, 100 mm Page 240

Accessories for pressure gauges

 Protective covers Page 241

 Profile seals for pressure gauge Page 241

 Self-sealing nipples Page 241

 Nipples for pressure gauge Page 241-242



Accessories for pressure gauges

 Galvanised steel
acc. DIN 2353
Page 242

 Pressure gauge stopcocks
Page 243

 Pressure gauge valves
Page 244

 Pressure gauge double
blocking valves
Page 245

 Siphons
Page 245

 Tension sleeves
Page 246

 Pulsation dampers
Page 246

 Pushbutton stopcock
Page 247

 Pressure gauge in-line filters
Page 247

 Instrument holders
Page 248

 Front glasses
Page 248

Accessories for pressure gauges

 Adhesive label set
for pressure gauges
Page 249

 Adjustment key
Page 249

 Clamp fixing
Page 249

 Front ring
Page 250

 Glycerin
Page 250

Digital pressure gauges

 Digital pressure gauge
Page 251

Pressure transmitters

 Pressure transmitters,
type A-10
Page 252

 Pressure transmitters,
type S-20
Page 253

 Pressure transmitters,
type S-10
Page 254

 Pressure transmitters,
type S-11
Page 255

Digital display units

 Microprocessor-controlled
digital display unit
Page 256

 Digital plug-in display
Page 256

Thermometers

 Bimetallic thermometers
for heating plants
Page 257

 Bimetallic thermometers
industrial type
Page 257

 Bimetallic thermometers
high-quality type
Page 258

 Screw-in
thermowells
Page 259

 Weld-in
thermowells
Page 259

Notes

A large grid of small dots for taking notes, covering most of the page.



Standard pressure gauges

with plastic housing and dual scale in bar/psi

PLUS

Bourdon-tube pressure gauge in standard design.

Suitable for gaseous or liquid media which do not corrode copper alloy, do not have high viscosity and do not crystallise.

Housing	Plastic
Measuring element	Copper alloy
Movement	Copper alloy
Front glass	Transparent plastic
Medium temperature	-20 to 60 °C
Ambient temperature	-20 to 60 °C



117-KD

Standard pressure gauge, connection radial on bottom

Art. No.	Type No.	Type	Accuracy class	Measuring range bar	Measuring range psi	Diameter mm	Connection
101652	110.32-KD	111.10	1.6	0 to 2,5	0 - 36	40	G 1/8
101653	110.33-KD	111.10	1.6	0 to 4	0 - 58	40	G 1/8
101654	110.34-KD	111.10	1.6	0 to 6	0 - 87	40	G 1/8
101655	110.35-KD	111.10	1.6	0 to 10	0 - 145	40	G 1/8
101656	110.36-KD	111.10	1.6	0 to 16	0 - 230	40	G 1/8
101657	110.37-KD	111.10	1.6	0 to 25	0 - 360	40	G 1/8
101658	103-KD	111.10	1.6	0 to 2,5	0 - 36	50	G 1/4
101659	104-KD	111.10	1.6	0 to 4	0 - 58	50	G 1/4
101660	105-KD	111.10	1.6	0 to 6	0 - 87	50	G 1/4
101661	106-KD	111.10	1.6	0 to 10	0 - 145	50	G 1/4
101662	107-KD	111.10	1.6	0 to 16	0 - 230	50	G 1/4
101663	108-KD	111.10	2.5	0 to 25	0 - 360	50	G 1/4
101664	114-KD	111.10	1.6	0 to 2,5	0 - 36	63	G 1/4
101665	115-KD	111.10	1.6	0 to 4	0 - 58	63	G 1/4
101666	116-KD	111.10	1.6	0 to 6	0 - 87	63	G 1/4
101667	117-KD	111.10	1.6	0 to 10	0 - 145	63	G 1/4
101668	118-KD	111.10	1.6	0 to 16	0 - 230	63	G 1/4
101669	119-KD	111.10	1.6	0 to 25	0 - 360	63	G 1/4



218-KD

Standard pressure gauge, connection on rear, central

Art. No.	Type No.	Type	Accuracy class	Measuring range bar	Measuring range psi	Diameter mm	Connection
101670	110.43-KD	111.12	1.6	0 to 2,5	0 - 36	40	G 1/8
101671	110.44-KD	111.12	1.6	0 to 4	0 - 58	40	G 1/8
101533	110.45-KD	111.12	1.6	0 to 6	0 - 87	40	G 1/8
101672	110.46-KD	111.12	1.6	0 to 10	0 - 145	40	G 1/8
101534	110.47-KD	111.12	1.6	0 to 16	0 - 230	40	G 1/8
101673	110.48-KD	111.12	1.6	0 to 25	0 - 360	40	G 1/8
101674	203-KD	111.12	1.6	0 to 2,5	0 - 36	50	G 1/4
101675	204-KD	111.12	1.6	0 to 4	0 - 58	50	G 1/4
101676	205-KD	111.12	1.6	0 to 6	0 - 87	50	G 1/4
101677	206-KD	111.12	1.6	0 to 10	0 - 145	50	G 1/4
101678	207-KD	111.12	1.6	0 to 16	0 - 230	50	G 1/4
101679	208-KD	111.12	1.6	0 to 25	0 - 360	50	G 1/4
101222	214-KD	111.12	1.6	0 to 2,5	0 - 36	63	G 1/4
101223	215-KD	111.12	1.6	0 to 4	0 - 58	63	G 1/4
101224	216-KD	111.12	1.6	0 to 6	0 - 87	63	G 1/4
101244	217-KD	111.12	1.6	0 to 10	0 - 145	63	G 1/4
101398	218-KD	111.12	1.6	0 to 16	0 - 230	63	G 1/4
101462	219-KD	111.12	1.6	0 to 25	0 - 360	63	G 1/4

Standard pressure gauges

with plastic housing and single scale in bar

PLUS

Bourdon-tube pressure gauge in standard design.

Suitable for gaseous or liquid media which do not corrode copper alloy, do not have high viscosity and do not crystallise.

Type	111.10
Housing	Plastic
Measuring element	Copper alloy
Movement	Copper alloy
Front glass	Transparent plastic
Medium temperature	-20 to 60 °C
Ambient temperature	-20 to 60 °C

Standard pressure gauge, connection radial on bottom

Art. No.	Type No.	Accuracy class	Measuring range bar	Diameter mm	Connection
101680	110.30-K	1.6	-1 to 0	40	G 1/8
101681	110.31-K	1.6	0 to 1,6	40	G 1/8
101682	110.32-K	1.6	0 to 2,5	40	G 1/8
101683	110.33-K	1.6	0 to 4	40	G 1/8
101684	110.34-K	1.6	0 to 6	40	G 1/8
101685	110.35-K	1.6	0 to 10	40	G 1/8
101686	110.36-K	1.6	0 to 16	40	G 1/8
101687	110.37-K	2.5	0 to 25	40	G 1/8
101688	110.38-K	1.6	0 to 40	40	G 1/8
101689	100-K	1.6	-1 to 0	50	G 1/4
101690	101-K	1.6	0 to 1	50	G 1/4
101691	102-K	1.6	0 to 1,6	50	G 1/4
101692	103-K	1.6	0 to 2,5	50	G 1/4
101693	104-K	1.6	0 to 4	50	G 1/4
101694	105-K	1.6	0 to 6	50	G 1/4
101695	106-K	1.6	0 to 10	50	G 1/4
101696	107-K	1.6	0 to 16	50	G 1/4
101697	108-K	1.6	0 to 25	50	G 1/4
101698	109-K	1.6	0 to 40	50	G 1/4
101699	110-K	1.6	0 to 60	50	G 1/4
101700	110/1-K	1.6	0 to 100	50	G 1/4
101701	110/2-K	2.5	0 to 160	50	G 1/4
101702	6300-K	2.5		63	G 1/4
101703	6301-K	1.6	-1 to 0	63	G 1/4
101704	6302-K	1.6	-1 to 0,6	63	G 1/4
101705	6303-K	1.6	-1 to 1,5	63	G 1/4
101706	6304-K	1.6	-1 to 3	63	G 1/4
101707	6305-K	2.5	-1 to 5	63	G 1/4
101708	6306-K	1.6	-1 to 9	63	G 1/4
101709	6307-K	1.6	-1 to 15	63	G 1/4
101710	111-K	1.6	0 to 0,6	63	G 1/4
101711	112-K	1.6	0 to 1	63	G 1/4
101712	113-K	1.6	0 to 1,6	63	G 1/4
101713	114-K	1.6	0 to 2,5	63	G 1/4
101714	115-K	1.6	0 to 4	63	G 1/4
101715	116-K	1.6	0 to 6	63	G 1/4
101716	117-K	1.6	0 to 10	63	G 1/4
101717	118-K	1.6	0 to 16	63	G 1/4
101718	119-K	1.6	0 to 25	63	G 1/4
101719	120-K	1.6	0 to 40	63	G 1/4
101720	121-K	1.6	0 to 60	63	G 1/4
101721	122-K	1.6	0 to 100	63	G 1/4
101722	123-K	1.6	0 to 160	63	G 1/4



Standard pressure gauges

with plastic housing and single scale in bar

PLUS

Standard pressure gauge, connection radial on bottom

Art. No.	Type No.	Accuracy class	Measuring range bar	Diameter mm	Connection
101723	124-K	1.6	0 to 250	63	G 1/4
101724	125-K	1.6	0 to 315	63	G 1/4
101725	126-K	1.6	0 to 400	63	G 1/4

- You can find standard pressure gauges with sheet steel housing on page 207-208
- You can find standard pressure gauges with a dual scale in bar/psi on page 204

Standard pressure gauges

with plastic housing and single scale in bar

PLUS

Bourdon-tube pressure gauge in standard design.

Suitable for gaseous or liquid media which do not corrode copper alloy, do not have high viscosity and do not crystallise.

Type	111.12
Housing	Plastic
Measuring element	Copper alloy
Movement	Copper alloy
Front glass	Transparent plastic
Medium temperature	-20 to 60 °C
Ambient temperature	-20 to 60 °C

Standard pressure gauge, connection on rear, central

Art. No.	Type No.	Accuracy class	Measuring range bar	Diameter mm	Connection
101726	110.41-K	1.6	-1 to 0	40	G 1/8
101811	110.41/1	1.6	0 to 1	40	G 1/8
101727	110.42-K	1.6	0 to 1,6	40	G 1/8
101728	110.43-K	1.6	0 to 2,5	40	G 1/8
101729	110.44-K	1.6	0 to 4	40	G 1/8
101730	110.45-K	1.6	0 to 6	40	G 1/8
101731	110.46-K	1.6	0 to 10	40	G 1/8
101732	110.47-K	1.6	0 to 16	40	G 1/8
101733	110.48-K	1.6	0 to 25	40	G 1/8
101734	110.49-K	1.6	0 to 40	40	G 1/8
101735	200-K	1.6	-1 to 0	50	G 1/4
101736	201-K	1.6	0 to 1	50	G 1/4
101737	202-K	1.6	0 to 1,6	50	G 1/4
101738	203-K	1.6	0 to 2,5	50	G 1/4
101739	204-K	1.6	0 to 4	50	G 1/4
101740	205-K	1.6	0 to 6	50	G 1/4
101741	206-K	1.6	0 to 10	50	G 1/4
101742	207-K	1.6	0 to 16	50	G 1/4
101743	208-K	1.6	0 to 25	50	G 1/4
101744	209-K	2.5	0 to 40	50	G 1/4
101745	210-K	1.6	0 to 60	50	G 1/4
101746	210/1-K	1.6	0 to 100	50	G 1/4
101747	211/1-K	1.6	-1 to 0	63	G 1/4
101748	211-K	1.6	0 to 0,6	63	G 1/4
101749	212-K	1.6	0 to 1	63	G 1/4



218-K

Standard pressure gauges

with plastic housing and single scale in bar

PLUS

Standard pressure gauge, connection on rear, central

Art. No.	Type No.	Accuracy class	Measuring range bar	Diameter mm	Connection
101750	213-K	1.6	0 to 1,6	63	G 1/4
101751	214-K	1.6	0 to 2,5	63	G 1/4
101752	215-K	1.6	0 to 4	63	G 1/4
101753	216-K	1.6	0 to 6	63	G 1/4
101754	217-K	1.6	0 to 10	63	G 1/4
101755	218-K	1.6	0 to 16	63	G 1/4
101756	219-K	1.6	0 to 25	63	G 1/4
101757	220-K	1.6	0 to 40	63	G 1/4
101758	221-K	1.6	0 to 60	63	G 1/4
101759	222-K	2.5	0 to 100	63	G 1/4
101760	223-K	1.6	0 to 160	63	G 1/4
101761	224-K	2.5	0 to 250	63	G 1/4
101762	225-K	1.6	0 to 315	63	G 1/4
101763	226-K	1.6	0 to 400	63	G 1/4

- You can find standard pressure gauges with a sheet steel housing on page 207-208
- You can find standard pressure gauges with a dual scale in bar/psi on page 204



Standard pressure gauges

with sheet steel housing and single scale in bar

PLUS

Bourdon-tube pressure gauge in standard design.

Suitable for gaseous or liquid media which do not corrode copper alloy, do not have high viscosity and do not crystallise.

Type	111.10
Housing	Sheet steel
Measuring element	Copper alloy
Movement	Copper alloy
Front glass	Transparent plastic
Medium temperature	-20 to 60 °C
Ambient temperature	-20 to 60 °C

Standard pressure gauge, connection radial on bottom

Art. No.	Type No.	Accuracy class	Measuring range bar	Diameter mm	Connection
101764	110.30	1.6	-1 to 0	40	G 1/8
101765	110.31	1.6	0 to 1,6	40	G 1/8
101766	110.32	1.6	0 to 2,5	40	G 1/8
101767	110.33	1.6	0 to 4	40	G 1/8
101768	110.34	1.6	0 to 6	40	G 1/8
101769	110.35	1.6	0 to 10	40	G 1/8
101770	110.36	1.6	0 to 16	40	G 1/8
101771	110.37	1.6	0 to 25	40	G 1/8
101772	110.38	1.6	0 to 40	40	G 1/8
101773	100	1.6	-1 to 0	50	G 1/4
101774	101	1.6	0 to 1	50	G 1/4
101775	102	1.6	0 to 1,6	50	G 1/4
101776	103	1.6	0 to 2,5	50	G 1/4
101777	104	1.6	0 to 4	50	G 1/4
101778	105	2.5	0 to 6	50	G 1/4



Standard pressure gauges

with sheet steel housing and single scale in bar

PLUS



118

Standard pressure gauge, connection radial on bottom

Art. No.	Type No.	Accuracy class	Measuring range bar	Diameter mm	Connection
101408	106	1.6	0 to 10	50	G 1/4
101779	107	1.6	0 to 16	50	G 1/4
101780	108	1.6	0 to 25	50	G 1/4
101781	109	1.6	0 to 40	50	G 1/4
101782	110	1.6	0 to 60	50	G 1/4
101783	110/1	1.6	0 to 100	50	G 1/4
101784	110/2	1.6	0 to 160	50	G 1/4
101785	6300	2.5		63	G 1/4
101786	6301	1.6	-1 to 0	63	G 1/4
101787	6302	1.6	-1 to 0,6	63	G 1/4
101788	6303	1.6	-1 to 1,5	63	G 1/4
101789	6304	1.6	-1 to 3	63	G 1/4
101790	6305	1.6	-1 to 5	63	G 1/4
101791	6306	1.6	-1 to 9	63	G 1/4
101792	6307	1.6	-1 to 15	63	G 1/4
101793	111	1.6	0 to 0,6	63	G 1/4
101794	112	1.6	0 to 1	63	G 1/4
101795	113	1.6	0 to 1,6	63	G 1/4
101796	114	1.6	0 to 2,5	63	G 1/4
101797	115	1.6	0 to 4	63	G 1/4
101798	116	1.6	0 to 6	63	G 1/4
101799	117	1.6	0 to 10	63	G 1/4
101800	118	1.6	0 to 16	63	G 1/4
101801	119	1.6	0 to 25	63	G 1/4
101802	120	1.6	0 to 40	63	G 1/4
101803	121	1.6	0 to 60	63	G 1/4
101804	122	1.6	0 to 100	63	G 1/4
101805	123	2.5	0 to 160	63	G 1/4
101806	124	1.6	0 to 250	63	G 1/4
101807	125	1.6	0 to 315	63	G 1/4
101808	126	1.6	0 to 400	63	G 1/4
101809	127	1.6	0 to 600	63	G 1/4

→ You can find standard pressure gauges with a dual scale in bar/psi on page 204

Standard pressure gauges

with sheet steel housing and single scale in bar

PLUS

Bourdon-tube pressure gauge in standard design.

Suitable for gaseous or liquid media which do not corrode copper alloy, do not have high viscosity and do not crystallise.

Type	111.12
Housing	Sheet steel
Measuring element	Copper alloy
Movement	Copper alloy
Front glass	Transparent plastic
Medium temperature	-20 to 60 °C
Ambient temperature	-20 to 60 °C

Standard pressure gauge, connection on rear, central

Art. No.	Type No.	Accuracy class	Measuring range bar	Diameter mm	Connection
101810	110.41	1.6	-1 to 0	40	G 1/8
101812	110.42	1.6	0 to 1,6	40	G 1/8
101813	110.43	1.6	0 to 2,5	40	G 1/8
101814	110.44	1.6	0 to 4	40	G 1/8
101815	110.45	1.6	0 to 6	40	G 1/8
101816	110.46	1.6	0 to 10	40	G 1/8
101817	110.47	1.6	0 to 16	40	G 1/8
101818	110.48	1.6	0 to 25	40	G 1/8
101819	110.49	1.6	0 to 40	40	G 1/8
101820	200	1.6	-1 to 0	50	G 1/4
101821	201	1.6	0 to 1	50	G 1/4
101822	202	1.6	0 to 1,6	50	G 1/4
101823	203	1.6	0 to 2,5	50	G 1/4
101824	204	1.6	0 to 4	50	G 1/4
101825	205	1.6	0 to 6	50	G 1/4
101826	206	1.6	0 to 10	50	G 1/4
101827	207	1.6	0 to 16	50	G 1/4
101828	208	1.6	0 to 25	50	G 1/4
101829	209	1.6	0 to 40	50	G 1/4
101830	210	2.5	0 to 60	50	G 1/4
101831	210/1	2.5	0 to 100	50	G 1/4
101832	211/1	1.6	-1 to 0	63	G 1/4
101833	211	1.6	0 to 0,6	63	G 1/4
101834	212	1.6	0 to 1	63	G 1/4
101835	213	2.5	0 to 1,6	63	G 1/4
101836	214	1.6	0 to 2,5	63	G 1/4
101837	215	1.6	0 to 4	63	G 1/4
101838	216	1.6	0 to 6	63	G 1/4
101839	217	1.6	0 to 10	63	G 1/4
101840	218	1.6	0 to 16	63	G 1/4
101841	219	1.6	0 to 25	63	G 1/4
101842	220	1.6	0 to 40	63	G 1/4
101843	221	1.6	0 to 60	63	G 1/4
101844	222	1.6	0 to 100	63	G 1/4
101845	223	1.6	0 to 160	63	G 1/4
101846	224	1.6	0 to 250	63	G 1/4
101847	225	2.5	0 to 315	63	G 1/4
101848	226	1.6	0 to 400	63	G 1/4



218

➔ You can find standard pressure gauges with a dual scale in bar/psi on page 204

Standard pressure gauges

panel-mounting type, with sheet steel housing

PLUS

Bourdon-tube pressure gauge in standard design, either with panel-mounting bezel made of chrome-plated or black sheet steel or with 3-hole bezel made of chrome-plated sheet steel.

Suitable for gaseous or liquid media which do not corrode copper alloy, do not have high viscosity and do not crystallise.

Type	111.12
Housing	Sheet steel
Measuring element	Copper alloy
Movement	Copper alloy
Front glass	Transparent plastic
Medium temperature	-20 to 60 °C
Ambient temperature	-20 to 60 °C

Standard pressure gauge with chrome-plated sheet-steel bezel, single scale in bar, connection on rear, central

Art. No.	Type No.	Accuracy class	Measuring range bar	Diameter mm	Connection
101849	300/40	1.6	-1 to 0	40	G 1/8
101850	301/40	1.6	0 to 1	40	G 1/8
101851	302/40	1.6	0 to 1,6	40	G 1/8
101852	303/40	1.6	0 to 2,5	40	G 1/8
101853	304/40	1.6	0 to 4	40	G 1/8
101854	305/40	1.6	0 to 6	40	G 1/8
101855	306/40	1.6	0 to 10	40	G 1/8
101856	307/40	1.6	0 to 16	40	G 1/8
101857	308/40	1.6	0 to 25	40	G 1/8
101858	309/40	1.6	0 to 40	40	G 1/8
101859	300/50	1.6	-1 to 0	50	G 1/4
101860	301/50	1.6	0 to 1	50	G 1/4
101861	302/50	1.6	0 to 1,6	50	G 1/4
101862	303/50	1.6	0 to 2,5	50	G 1/4
101863	304/50	1.6	0 to 4	50	G 1/4
101864	305/50	1.6	0 to 6	50	G 1/4
101865	306/50	1.6	0 to 10	50	G 1/4
101866	307/50	1.6	0 to 16	50	G 1/4
101867	308/50	1.6	0 to 25	50	G 1/4
101868	309/50	1.6	0 to 40	50	G 1/4
101869	300/63	1.6	-1 to 0	63	G 1/4
101870	301/63	1.6	0 to 1	63	G 1/4
101871	302/63	1.6	0 to 1,6	63	G 1/4
101872	303/63	1.6	0 to 2,5	63	G 1/4
101873	304/63	1.6	0 to 4	63	G 1/4
101874	305/63	1.6	0 to 6	63	G 1/4
101875	306/63	1.6	0 to 10	63	G 1/4
101876	307/63	1.6	0 to 16	63	G 1/4
101877	308/63	1.6	0 to 25	63	G 1/4
101878	309/63	1.6	0 to 40	63	G 1/4



306/63

Standard pressure gauge with black sheet-steel bezel, single scale in bar, connection on rear, central

Art. No.	Type No.	Accuracy class	Measuring range bar	Diameter mm	Connection
101879	319/40	1.6	-1 to 0	40	G 1/8
101880	320/40	1.6	0 to 1	40	G 1/8
101881	321/40	1.6	0 to 1,6	40	G 1/8
101882	322/40	1.6	0 to 2,5	40	G 1/8
101883	323/40	1.6	0 to 4	40	G 1/8
101884	324/40	1.6	0 to 6	40	G 1/8
101885	325/40	1.6	0 to 10	40	G 1/8

Standard pressure gauges

panel-mounting type, with sheet steel housing

PLUS

Standard pressure gauge with black sheet-steel bezel, single scale in bar, connection on rear, central

Art. No.	Type No.	Accuracy class	Measuring range bar	Diameter mm	Connection
101886	326/40	1.6	0 to 16	40	G 1/8
101887	327/40	1.6	0 to 25	40	G 1/8
101888	328/40	1.6	0 to 40	40	G 1/8
101889	319/50	1.6	-1 to 0	50	G 1/4
101890	320/50	1.6	0 to 1	50	G 1/4
101891	321/50	1.6	0 to 1,6	50	G 1/4
101892	322/50	1.6	0 to 2,5	50	G 1/4
101893	323/50	1.6	0 to 4	50	G 1/4
101894	324/50	1.6	0 to 6	50	G 1/4
101895	325/50	1.6	0 to 10	50	G 1/4
101896	326/50	1.6	0 to 16	50	G 1/4
101897	327/50	1.6	0 to 25	50	G 1/4
101898	328/50	1.6	0 to 40	50	G 1/4
101899	329/50	1.6	0 to 60	50	G 1/4
101900	319/63	1.6	-1 to 0	63	G 1/4
101901	320/63	1.6	0 to 1	63	G 1/4
101902	321/63	1.6	0 to 1,6	63	G 1/4
101903	322/63	1.6	0 to 2,5	63	G 1/4
101904	323/63	1.6	0 to 4	63	G 1/4
101905	324/63	1.6	0 to 6	63	G 1/4
101906	325/63	1.6	0 to 10	63	G 1/4
101907	326/63	1.6	0 to 16	63	G 1/4
101908	327/63	1.6	0 to 25	63	G 1/4
101909	328/63	1.6	0 to 40	63	G 1/4
101910	329/63	1.6	0 to 60	63	G 1/4



325/63

Standard pressure gauge with 3-hole bezel, chrome-plated steel, dual scale in bar/psi, clamp fixing, connection on rear, central

Art. No.	Type No.	Accuracy class	Measuring range bar	Measuring range psi	Diameter mm	Connection
101911	110.70	2.5	-1 to 0	-14,5 - 0	40	G 1/8
101912	110.71	2.5	0 to 1	0 - 14,5	40	G 1/8
101913	110.72	2.5	0 to 1,6	0 - 23	40	G 1/8
101914	110.73	2.5	0 to 2,5	0 - 36	40	G 1/8
101915	110.74	2.5	0 to 4	0 - 58	40	G 1/8
101916	110.75	2.5	0 to 6	0 - 86	40	G 1/8
101917	110.76	2.5	0 to 10	0 - 145	40	G 1/8
101918	110.77	2.5	0 to 16	0 - 230	40	G 1/8
101919	110.78	2.5	0 to 25	0 - 360	40	G 1/8
101920	110.80	2.5	-1 to 0	-14,5 - 0	50	G 1/4
101921	110.81	2.5	0 to 1	0 - 14,5	50	G 1/4
101922	110.82	2.5	0 to 1,6	0 - 23	50	G 1/4
101923	110.83	2.5	0 to 2,5	0 - 36	50	G 1/4
101924	110.84	2.5	0 to 4	0 - 58	50	G 1/4
101925	110.85	2.5	0 to 6	0 - 87	50	G 1/4
101926	110.86	2.5	0 to 10	0 - 145	50	G 1/4
101927	110.87	2.5	0 to 16	0 - 230	50	G 1/4
101928	110.88	2.5	0 to 25	0 - 360	50	G 1/4
101929	110.90	2.5	-1 to 0	-14,5 - 0	63	G 1/4
101930	110.91	2.5	0 to 1	0 - 14,5	63	G 1/4
101931	110.92	2.5	0 to 1,6	0 - 23	63	G 1/4
101932	110.93	2.5	0 to 2,5	0 - 36	63	G 1/4
101933	110.94	2.5	0 to 4	0 - 58	63	G 1/4



110.96



Standard pressure gauges

panel-mounting type, with sheet steel housing

PLUS

Standard pressure gauge with 3-hole bezel, chrome-plated steel, dual scale in bar/psi, clamp fixing, connection on rear, central

Art. No.	Type No.	Accuracy class	Measuring range bar	Measuring range psi	Diameter mm	Connection
101934	110.95	2.5	0 to 6	0 - 86	63	G 1/4
101935	110.96	2.5	0 to 10	0 - 145	63	G 1/4
101936	110.97	2.5	0 to 16	0 - 230	63	G 1/4
101937	110.98	2.5	0 to 25	0 - 360	63	G 1/4
101938	110.99	2.5	0 to 40	0 - 580	63	G 1/4
101939	110.100	2.5	0 to 60	0 - 860	63	G 1/4
101940	110.101	2.5	0 to 100	0 - 1450	63	G 1/4
101941	110.102	2.5	0 to 160	0 - 2300	63	G 1/4
101942	110.103	2.5	0 to 250	0 - 3600	63	G 1/4
101943	110.104	2.5	0 to 400	0 - 5800	63	G 1/4

Standard pressure gauges

Ø 80-160 with plastic or sheet steel housing and single scale in bar

PLUS

Bourdon-tube pressure gauge in standard design.

Suitable for gaseous or liquid media which do not corrode copper alloy, do not have high viscosity and do not crystallise.

Measuring element	Copper alloy
Movement	Copper alloy
Medium temperature	-20 to 60 °C
Ambient temperature	-20 to 60 °C



147

Standard pressure gauge, connection radial on bottom, type 111.10

Art. No.	Type No.	Accuracy class	Housing	Front glass	Reference pointer	Measuring range bar	Diameter mm	Connection
101944	5301	1.6	Plastic	Transparent plastic	-	-1 to 0	80	G 1/2
101945	5303	1.6	Plastic	Transparent plastic	-	-1 to 1,5	80	G 1/2
101946	5304	1.6	Plastic	Transparent plastic	-	-1 to 3	80	G 1/2
101947	5305	1.6	Plastic	Transparent plastic	-	-1 to 5	80	G 1/2
101948	5306	1.6	Plastic	Transparent plastic	-	-1 to 9	80	G 1/2
101949	5307	1.6	Plastic	Transparent plastic	-	-1 to 15	80	G 1/2
101950	130	2.5	Plastic	Transparent plastic	red	0 to 0,6	80	G 1/2
101951	131	1.6	Plastic	Transparent plastic	red	0 to 1	80	G 1/2
101952	132	1.6	Plastic	Transparent plastic	red	0 to 1,6	80	G 1/2
101953	133	2.5	Plastic	Transparent plastic	red	0 to 2,5	80	G 1/2
101954	134	1.6	Plastic	Transparent plastic	red	0 to 4	80	G 1/2
101955	135	1.6	Plastic	Transparent plastic	red	0 to 6	80	G 1/2
101956	136	1.6	Plastic	Transparent plastic	red	0 to 10	80	G 1/2

Standard pressure gauges

Ø 80-160 with plastic or sheet steel housing and single scale in bar

PLUS

Standard pressure gauge, connection radial on bottom, type 111.10

Art. No.	Type No.	Accuracy class	Housing	Front glass	Reference pointer	Measuring range bar	Diameter mm	Connection
101957	137	1.6	Plastic	Transparent plastic	red	0 to 16	80	G 1/2
101958	138	1.6	Plastic	Transparent plastic	red	0 to 25	80	G 1/2
101959	139	1.6	Plastic	Transparent plastic	red	0 to 40	80	G 1/2
101960	140	1.6	Plastic	Transparent plastic	red	0 to 60	80	G 1/2
101961	7300	2.5	Plastic	Transparent plastic	-		100	G 1/2
101962	7301	1.6	Plastic	Transparent plastic	-	-1 to 0	100	G 1/2
101963	7302	2.5	Plastic	Transparent plastic	-	-1 to 0,6	100	G 1/2
101964	7303	1.6	Plastic	Transparent plastic	-	-1 to 1,5	100	G 1/2
101965	7304	1.6	Plastic	Transparent plastic	-	-1 to 3	100	G 1/2
101966	7305	1.6	Plastic	Transparent plastic	-	-1 to 5	100	G 1/2
101967	7306	1.6	Plastic	Transparent plastic	-	-1 to 9	100	G 1/2
101968	141	1.6	Plastic	Transparent plastic	red	0 to 0,6	100	G 1/2
101969	142	1.6	Plastic	Transparent plastic	red	0 to 1	100	G 1/2
101970	143	1.6	Plastic	Transparent plastic	red	0 to 1,6	100	G 1/2
101971	144	1.6	Plastic	Transparent plastic	red	0 to 2,5	100	G 1/2
101972	145	1.6	Plastic	Transparent plastic	red	0 to 4	100	G 1/2
101973	146	1.6	Plastic	Transparent plastic	red	0 to 6	100	G 1/2
101974	147	1.6	Plastic	Transparent plastic	red	0 to 10	100	G 1/2
101975	148	1.6	Plastic	Transparent plastic	red	0 to 16	100	G 1/2
101976	149	1.6	Plastic	Transparent plastic	red	0 to 25	100	G 1/2
101977	150	2.5	Plastic	Transparent plastic	red	0 to 40	100	G 1/2
101978	150/1	1.6	Plastic	Transparent plastic	red	0 to 60	100	G 1/2
101979	150/2	1.6	Plastic	Transparent plastic	red	0 to 100	100	G 1/2
101980	150/3	1.6	Plastic	Transparent plastic	red	0 to 160	100	G 1/2
101981	8300	1.6	Sheet steel	Flat instrument glass	-		160	G 1/2
101982	8301	1.6	Sheet steel	Flat instrument glass	-	-1 to 0	160	G 1/2
101983	8303	1.6	Sheet steel	Flat instrument glass	-	-1 to 1,5	160	G 1/2
101984	8304	1.6	Sheet steel	Flat instrument glass	-	-1 to 3	160	G 1/2
101985	8305	1.6	Sheet steel	Flat instrument glass	-	-1 to 5	160	G 1/2
101986	8306	1.6	Sheet steel	Flat instrument glass	-	-1 to 9	160	G 1/2
101987	151	1.6	Sheet steel	Flat instrument glass	red	0 to 0,6	160	G 1/2



147



Standard pressure gauges

Ø 80-160 with plastic or sheet steel housing and single scale in bar

PLUS

Standard pressure gauge, connection radial on bottom, type 111.10

Art. No.	Type No.	Accuracy class	Housing	Front glass	Reference pointer	Measuring range bar	Diameter mm	Connection
101988	152	1.6	Sheet steel	Flat instrument glass	red	0 to 1	160	G 1/2
101989	153	1.6	Sheet steel	Flat instrument glass	red	0 to 1,6	160	G 1/2
101990	154	1.6	Sheet steel	Flat instrument glass	red	0 to 2,5	160	G 1/2
101991	155	1.6	Sheet steel	Flat instrument glass	red	0 to 4	160	G 1/2
101992	156	1.6	Sheet steel	Flat instrument glass	red	0 to 6	160	G 1/2
101993	157	1.6	Sheet steel	Flat instrument glass	red	0 to 10	160	G 1/2
101994	158	1.6	Sheet steel	Flat instrument glass	red	0 to 16	160	G 1/2
101995	159	1.6	Sheet steel	Flat instrument glass	red	0 to 25	160	G 1/2
101996	160	1.6	Sheet steel	Flat instrument glass	red	0 to 40	160	G 1/2

Standard pressure gauge, connection on rear, central, type 111.12

Art. No.	Type No.	Accuracy class	Housing	Front glass	Reference pointer	Measuring range bar	Diameter mm	Connection
101997	229	2.5	Plastic	Transparent plastic	-	-1 to 0	80	G 1/4
101998	231	2.5	Plastic	Transparent plastic	red	0 to 1	80	G 1/4
101999	232	2.5	Plastic	Transparent plastic	red	0 to 1,6	80	G 1/4
102000	233	1.6	Plastic	Transparent plastic	red	0 to 2,5	80	G 1/4
102001	234	1.6	Plastic	Transparent plastic	red	0 to 4	80	G 1/4
102002	235	1.6	Plastic	Transparent plastic	red	0 to 6	80	G 1/4
102003	236	1.6	Plastic	Transparent plastic	red	0 to 10	80	G 1/4
102004	237	1.6	Plastic	Transparent plastic	red	0 to 16	80	G 1/4
102005	238	2.5	Plastic	Transparent plastic	red	0 to 25	80	G 1/4
102006	239	1.6	Plastic	Transparent plastic	red	0 to 40	80	G 1/4
102007	250	1.6	Sheet steel	Transparent plastic	-	-1 to 0	100	G 1/4
102008	251	1.6	Sheet steel	Transparent plastic	red	0 to 1	100	G 1/4
102009	252	1.6	Sheet steel	Transparent plastic	red	0 to 1,6	100	G 1/4
102010	253	1.6	Sheet steel	Transparent plastic	red	0 to 2,5	100	G 1/4
102011	254	2.5	Sheet steel	Transparent plastic	red	0 to 4	100	G 1/4
102012	255	2.5	Sheet steel	Transparent plastic	red	0 to 6	100	G 1/4
102013	256	1.6	Sheet steel	Transparent plastic	red	0 to 10	100	G 1/4
102014	257	1.6	Sheet steel	Transparent plastic	red	0 to 16	100	G 1/4
102015	258	2.5	Sheet steel	Transparent plastic	red	0 to 25	100	G 1/4



257

Glycerine-filled pressure gauges

with plastic housing and dual scale in bar/psi

EASY

Glycerine-filled bourdon-tube pressure gauge.

For measurements in areas with high, dynamic pressure loads and vibration levels. Suitable for gaseous or liquid media which do not corrode copper alloy, do not have high viscosity and do not crystallise.

Type	113.13
Accuracy class	2.5
Housing	Plastic, black (with panel-mounting bezel)
Measuring element	Copper alloy
Movement	Copper alloy
Front glass	PMMA, welded to housing
Medium temperature	-20 to 60 °C
Ambient temperature	-20 to 60 °C

Glycerine-filled pressure gauge, connection radial on bottom

Art. No.	Type No.	Measuring range bar	Measuring range psi	Diameter mm	Connection
102068	700-K	-1 to 0	-14,5 - 0	63	G 1/4
102069	700/1-K	-1 to 0,6	-14,5 - 8,7	63	G 1/4
102070	700/2-K	-1 to 1,5	-14,5 - 21	63	G 1/4
102071	700/3-K	-1 to 3	-14,5 - 42	63	G 1/4
102072	700/4-K	-1 to 5	-14,5 - 72	63	G 1/4
102073	700/5-K	-1 to 9	-14,5 - 130	63	G 1/4
102074	702-K	0 to 1	0 - 14,5	63	G 1/4
102075	703-K	0 to 1,6	0 - 23	63	G 1/4
102076	704-K	0 to 2,5	0 - 36	63	G 1/4
102077	705-K	0 to 4	0 - 58	63	G 1/4
102078	706-K	0 to 6	0 - 86	63	G 1/4
102079	707-K	0 to 10	0 - 145	63	G 1/4
102080	708-K	0 to 16	0 - 230	63	G 1/4
102081	709-K	0 to 25	0 - 360	63	G 1/4
102082	710-K	0 to 40	0 - 580	63	G 1/4
102083	711-K	0 to 60	0 - 860	63	G 1/4
102084	712-K	0 to 100	0 - 1450	63	G 1/4
102085	713-K	0 to 160	0 - 2300	63	G 1/4
102086	714-K	0 to 250	0 - 3600	63	G 1/4
102087	715-K	0 to 400	0 - 5800	63	G 1/4



708-K

Glycerine-filled pressure gauge, connection on rear, central

Art. No.	Type No.	Measuring range bar	Measuring range psi	Diameter mm	Connection
102088	800-K	-1 to 0	-14,5 - 0	63	G 1/4
102089	800/1-K	-1 to 0,6	-14,5 - 8,7	63	G 1/4
102090	800/2-K	-1 to 1,5	-14,5 - 21	63	G 1/4
102091	800/3-K	-1 to 3	-14,5 - 44	63	G 1/4
102092	800/4-K	-1 to 5	-14,5 - 72	63	G 1/4
102093	800/5-K	-1 to 9	-14,5 - 130	63	G 1/4
102094	802-K	0 to 1	0 - 14,5	63	G 1/4
102095	803-K	0 to 1,6	0 - 23	63	G 1/4
102096	804-K	0 to 2,5	0 - 36	63	G 1/4
102097	805-K	0 to 4	0 - 58	63	G 1/4
102098	806-K	0 to 6	0 - 86	63	G 1/4
102099	807-K	0 to 10	0 - 145	63	G 1/4
102100	808-K	0 to 16	0 - 230	63	G 1/4
102101	809-K	0 to 25	0 - 360	63	G 1/4
102102	810-K	0 to 40	0 - 580	63	G 1/4
102103	811-K	0 to 60	0 - 860	63	G 1/4
102104	812-K	0 to 100	0 - 1450	63	G 1/4
102105	813-K	0 to 160	0 - 2300	63	G 1/4
102106	814-K	0 to 250	0 - 3600	63	G 1/4



808-K



Glycerine-filled pressure gauges

with plastic housing and dual scale in bar/psi

EASY

Glycerine-filled pressure gauge, connection on rear, central

Art. No.	Type No.	Measuring range bar	Measuring range psi	Diameter mm	Connection
102107	815-K	0 to 400	0 - 5800	63	G 1/4

- ➔ Glycerine-filled pressure gauge with clamp fixing (rear connection only) on request
- ➔ You can find glycerine-filled pressure gauges with a metal housing on page 217-219

Glycerine-filled pressure gauges

with CrNi steel housing and single scale in bar

PLUS

Glycerine-filled bourdon-tube pressure gauge.

For measurements in areas with high, dynamic pressure loads and vibration levels. Suitable for gaseous or liquid media which do not corrode copper alloy, do not have high viscosity and do not crystallise.

Type	213.53
Housing	CrNi steel, with bare metal surface
Crimped bezel	CrNi steel, with glossy metal surface (3-hole bezel)
Movement	Copper alloy
Front glass	Transparent plastic
Medium temperature	-20 to 60 °C
Ambient temperature	-20 to 60 °C



714-C

Glycerine-filled pressure gauge, connection radial on bottom

Art. No.	Type No.	Accuracy class	Measuring element	Measuring range bar	Diameter mm	Connection
102108	700-C	1.6	Copper alloy	-1 to 0	63	G 1/4
102109	702-C	1.6	Copper alloy	0 to 1	63	G 1/4
102110	703-C	1.6	Copper alloy	0 to 1,6	63	G 1/4
102111	704-C	1.6	Copper alloy	0 to 2,5	63	G 1/4
102112	705-C	1.6	Copper alloy	0 to 4	63	G 1/4
102113	706-C	1.6	Copper alloy	0 to 6	63	G 1/4
102114	707-C	1.6	Copper alloy	0 to 10	63	G 1/4
102115	708-C	1.6	Copper alloy	0 to 16	63	G 1/4
102116	709-C	1.6	Copper alloy	0 to 25	63	G 1/4
102117	710-C	1.6	Copper alloy	0 to 40	63	G 1/4
102118	711-C	1.6	Copper alloy	0 to 60	63	G 1/4
102119	712-C	1.6	Copper alloy	0 to 100	63	G 1/4
102120	713-C	1.6	Copper alloy	0 to 160	63	G 1/4
102121	714-C	1.6	Copper alloy	0 to 250	63	G 1/4
102122	714/1-C	1.6	Copper alloy	0 to 315	63	G 1/4
102123	715-C	1.6	Copper alloy	0 to 400	63	G 1/4
102124	716-C	1.6	CrNi steel	0 to 600	63	G 1/4
102125	720-C	1.0	Copper alloy	-1 to 0	100	G 1/2
102126	720/1-C	1.0	Copper alloy	-1 to 1,5	100	G 1/2
102127	720/2-C	1.0	Copper alloy	-1 to 3	100	G 1/2
102128	722-C	1.0	Copper alloy	0 to 1	100	G 1/2
102129	723-C	1.0	Copper alloy	0 to 1,6	100	G 1/2
102130	724-C	1.0	Copper alloy	0 to 2,5	100	G 1/2
102131	725-C	1.0	Copper alloy	0 to 4	100	G 1/2
102132	726-C	1.0	Copper alloy	0 to 6	100	G 1/2
102133	727-C	1.0	Copper alloy	0 to 10	100	G 1/2
102134	728-C	1.0	Copper alloy	0 to 16	100	G 1/2
102135	729-C	1.0	Copper alloy	0 to 25	100	G 1/2

Glycerine-filled pressure gauges

with CrNi steel housing and single scale in bar

PLUS

Glycerine-filled pressure gauge, connection radial on bottom

Art. No.	Type No.	Accuracy class	Measuring element	Measuring range bar	Diameter mm	Connection
102136	730-C	1.0	Copper alloy	0 to 40	100	G 1/2
102137	731-C	1.0	Copper alloy	0 to 60	100	G 1/2
102138	732-C	1.0	CrNi steel	0 to 100	100	G 1/2
102139	733-C	1.0	CrNi steel	0 to 160	100	G 1/2
102140	734-C	1.0	CrNi steel	0 to 250	100	G 1/2
102141	735-C	1.0	CrNi steel	0 to 400	100	G 1/2
102142	736-C	1.0	CrNi steel	0 to 600	100	G 1/2

Glycerine-filled pressure gauge, connection on rear, central

Art. No.	Type No.	Accuracy class	Measuring element	Measuring range bar	Diameter mm	Connection
102143	800-C	1.6	Copper alloy	-1 to 0	63	G 1/4
102144	802-C	1.6	Copper alloy	0 to 1	63	G 1/4
102145	803-C	1.6	Copper alloy	0 to 1,6	63	G 1/4
102146	804-C	1.6	Copper alloy	0 to 2,5	63	G 1/4
102147	805-C	1.6	Copper alloy	0 to 4	63	G 1/4
102148	806-C	1.6	Copper alloy	0 to 6	63	G 1/4
102149	807-C	1.6	Copper alloy	0 to 10	63	G 1/4
102150	808-C	1.6	Copper alloy	0 to 16	63	G 1/4
102151	809-C	1.6	Copper alloy	0 to 25	63	G 1/4
102152	810-C	1.6	Copper alloy	0 to 40	63	G 1/4
102153	811-C	1.6	Copper alloy	0 to 60	63	G 1/4
102154	812-C	1.6	Copper alloy	0 to 100	63	G 1/4
102155	813-C	1.6	Copper alloy	0 to 160	63	G 1/4
102156	814-C	1.6	Copper alloy	0 to 250	63	G 1/4
102157	815-C	1.6	Copper alloy	0 to 400	63	G 1/4
102158	816-C	1.6	CrNi steel	0 to 600	63	G 1/4
102159	818-C	1.6	CrNi steel	0 to 1000	63	G 1/4

→ Glycerine-filled pressure gauge with clamp fixing (rear connection only) on request



812-C



Glycerine-filled pressure gauges

with metal housing and single scale in bar

MAX

Glycerine-filled bourdon-tube pressure gauge.

For measurements in areas with high, dynamic pressure loads and vibration levels. Suitable for gaseous or liquid media which do not corrode copper alloy, do not have high viscosity and do not crystallise.

Type	213.40
Housing	Hot-pressed brass
Crimped bezel	CrNi steel
Movement	Copper alloy
Front glass	Plexiglass
Medium temperature	-20 to 60 °C
Ambient temperature	-20 to 60 °C

Glycerine-filled pressure gauge, connection radial on bottom

Art. No.	Type No.	Accuracy class	Measuring element	Measuring range bar	Diameter mm	Connection
102160	700	1.6	Copper alloy	-1 to 0	63	G 1/4
102161	700/1	1.6	Copper alloy	-1 to 0,6	63	G 1/4



713

Glycerine-filled pressure gauges

with metal housing and single scale in bar

MAX



713

Glycerine-filled pressure gauge, connection radial on bottom

Art. No.	Type No.	Accuracy class	Measuring element	Measuring range bar	Diameter mm	Connection
102160	700	1.6	Copper alloy	-1 to 0	63	G 1/4
102161	700/1	1.6	Copper alloy	-1 to 0,6	63	G 1/4
102162	700/2	1.6	Copper alloy	-1 to 1,5	63	G 1/4
102163	700/3	1.6	Copper alloy	-1 to 3	63	G 1/4
102164	700/4	1.6	Copper alloy	-1 to 5	63	G 1/4
102165	700/5	1.6	Copper alloy	-1 to 9	63	G 1/4
102166	700/6	1.6	Copper alloy	-1 to 15	63	G 1/4
102167	701	1.6	Copper alloy	0 to 0,6	63	G 1/4
102168	702	1.6	Copper alloy	0 to 1	63	G 1/4
102169	703	1.6	Copper alloy	0 to 1,6	63	G 1/4
102170	704	1.6	Copper alloy	0 to 2,5	63	G 1/4
102171	705	1.6	Copper alloy	0 to 4	63	G 1/4
102172	706	1.6	Copper alloy	0 to 6	63	G 1/4
102173	707	1.6	Copper alloy	0 to 10	63	G 1/4
102174	708	1.6	Copper alloy	0 to 16	63	G 1/4
102175	709	1.6	Copper alloy	0 to 25	63	G 1/4
102176	710	1.6	Copper alloy	0 to 40	63	G 1/4
102177	711	1.6	Copper alloy	0 to 60	63	G 1/4
102178	712	1.6	Copper alloy	0 to 100	63	G 1/4
102179	713	1.6	Copper alloy	0 to 160	63	G 1/4
102180	714	1.6	Copper alloy	0 to 250	63	G 1/4
102181	715	1.6	Copper alloy	0 to 400	63	G 1/4
102182	716	1.6	Copper alloy	0 to 600	63	G 1/4
102183	720	1.0	Copper alloy	-1 to 0	100	G 1/2
102184	720/1	1.0	Copper alloy	-1 to 0,6	100	G 1/2
102185	720/2	1.0	Copper alloy	-1 to 1,5	100	G 1/2
102186	720/3	1.0	Copper alloy	-1 to 3	100	G 1/2
102187	720/4	1.0	Copper alloy	-1 to 5	100	G 1/2
102188	720/5	1.0	Copper alloy	-1 to 9	100	G 1/2
102189	720/6	1.0	Copper alloy	-1 to 15	100	G 1/2
102190	721	1.0	Copper alloy	0 to 0,6	100	G 1/2
102191	722	1.0	Copper alloy	0 to 1	100	G 1/2
102192	723	1.0	Copper alloy	0 to 1,6	100	G 1/2
102193	724	1.0	Copper alloy	0 to 2,5	100	G 1/2
102194	725	1.0	Copper alloy	0 to 4	100	G 1/2
102195	726	1.0	Copper alloy	0 to 6	100	G 1/2
102196	727	1.0	Copper alloy	0 to 10	100	G 1/2
102197	728	1.0	Copper alloy	0 to 16	100	G 1/2
102198	729	1.0	Copper alloy	0 to 25	100	G 1/2
102199	730	1.0	Copper alloy	0 to 40	100	G 1/2
102200	731	1.0	Copper alloy	0 to 60	100	G 1/2
102201	732	1.0	CrNi steel 1.4571	0 to 100	100	G 1/2
102202	733	1.0	CrNi steel 1.4571	0 to 160	100	G 1/2
102203	734	1.0	CrNi steel 1.4571	0 to 250	100	G 1/2
102204	735	1.0	CrNi steel 1.4571	0 to 400	100	G 1/2
102205	736	1.0	CrNi steel 1.4571	0 to 600	100	G 1/2
102206	737	1.0	CrNi steel 1.4571	0 to 1000	100	G 1/2

Glycerine-filled pressure gauge, connection on rear, Ø 63 = central, Ø 100 = excentral

Art. No.	Type No.	Accuracy class	Measuring element	Measuring range bar	Diameter mm	Connection
102207	800	1.6	Copper alloy	-1 to 0	63	G 1/4
102208	800/1	1.6	Copper alloy	-1 to 0,6	63	G 1/4
102209	800/2	1.6	Copper alloy	-1 to 1,5	63	G 1/4
102210	800/3	1.6	Copper alloy	-1 to 3	63	G 1/4
102211	800/4	1.6	Copper alloy	-1 to 5	63	G 1/4
102212	800/5	1.6	Copper alloy	-1 to 9	63	G 1/4



807

Glycerine-filled pressure gauges

with metal housing and single scale in bar

MAX |||

Glycerine-filled pressure gauge, connection on rear, Ø 63 = central, Ø 100 = excentrical

Art. No.	Type No.	Accuracy class	Measuring element	Measuring range bar	Diameter mm	Connection
102213	800/6	1.6	Copper alloy	-1 to 15	63	G 1/4
102214	801	1.6	Copper alloy	0 to 0,6	63	G 1/4
102215	802	1.6	Copper alloy	0 to 1	63	G 1/4
102216	803	1.6	Copper alloy	0 to 1,6	63	G 1/4
102217	804	1.6	Copper alloy	0 to 2,5	63	G 1/4
102218	805	1.6	Copper alloy	0 to 4	63	G 1/4
102219	806	1.6	Copper alloy	0 to 6	63	G 1/4
102220	807	1.6	Copper alloy	0 to 10	63	G 1/4
102221	808	1.6	Copper alloy	0 to 16	63	G 1/4
102222	809	1.6	Copper alloy	0 to 25	63	G 1/4
102223	810	1.6	Copper alloy	0 to 40	63	G 1/4
102224	811	1.6	Copper alloy	0 to 60	63	G 1/4
102225	812	1.6	Copper alloy	0 to 100	63	G 1/4
102226	813	1.6	Copper alloy	0 to 160	63	G 1/4
102227	814	1.6	Copper alloy	0 to 250	63	G 1/4
102228	815	1.6	Copper alloy	0 to 400	63	G 1/4
102229	816	1.6	Copper alloy	0 to 600	63	G 1/4
102230	820	1.0	Copper alloy	-1 to 0	100	G 1/2
102231	821	1.0	Copper alloy	0 to 1	100	G 1/2
102232	822	1.0	Copper alloy	0 to 1,6	100	G 1/2
102233	823	1.0	Copper alloy	0 to 2,5	100	G 1/2
102234	824	1.0	Copper alloy	0 to 4	100	G 1/2
102235	825	1.0	Copper alloy	0 to 6	100	G 1/2
102236	826	1.0	Copper alloy	0 to 10	100	G 1/2
102237	827	1.0	Copper alloy	0 to 16	100	G 1/2
102238	828	1.0	Copper alloy	0 to 25	100	G 1/2
102239	829	1.0	Copper alloy	0 to 40	100	G 1/2
102240	830	1.0	Copper alloy	0 to 60	100	G 1/2
102241	831	1.0	CrNi steel 1.4571	0 to 100	100	G 1/2
102242	832	1.0	CrNi steel 1.4571	0 to 160	100	G 1/2
102243	833	1.0	CrNi steel 1.4571	0 to 250	100	G 1/2
102244	834	1.0	CrNi steel 1.4571	0 to 400	100	G 1/2
102245	835	1.0	CrNi steel 1.4571	0 to 600	100	G 1/2



807



➔ You can find glycerine-filled pressure gauges with a plastic housing on page 215-216

Glycerine-filled pressure gauges

panel-mounting type with hot-pressed brass housing and single scale in bar

MAX

Bourdon-tube pressure gauge in standard design, with panel-mounting bezel made of chrome-plated and polished steel.

For measurements in areas with high, dynamic pressure loads and vibration levels. Suitable for gaseous or liquid media which do not corrode copper alloy, do not have high viscosity and do not crystallise.

Type	213.40
Housing	Hot-pressed brass
Measuring element	Copper alloy
Movement	Copper alloy
Front glass	Plexiglass
Medium temperature	-20 to 60 °C
Ambient temperature	-20 to 60 °C



905

Glycerine-filled pressure gauge, steel bezel, chrome-plated and polished, connection on rear, Ø 63 = central, Ø 100 = excentrical

Art. No.	Type No.	Accuracy class	Measuring range bar	Diameter mm	Connection
102246	900	1.6	-1 to 0	63	G 1/4
102247	900/1	1.6	0 to 2,5	63	G 1/4
102248	901	1.6	0 to 4	63	G 1/4
102249	902	1.6	0 to 6	63	G 1/4
102250	903	1.6	0 to 10	63	G 1/4
102251	904	1.6	0 to 16	63	G 1/4
102252	905	1.6	0 to 25	63	G 1/4
102253	906	1.6	0 to 40	63	G 1/4
102254	907	1.6	0 to 60	63	G 1/4
102255	908	1.6	0 to 100	63	G 1/4
102256	909	1.6	0 to 160	63	G 1/4
102257	910	1.6	0 to 250	63	G 1/4
102258	911	1.6	0 to 400	63	G 1/4
102259	950	1.0	-1 to 0	100	G 1/2
102260	951	1.0	0 to 1	100	G 1/2
102261	952	1.0	0 to 1,6	100	G 1/2
102262	953	1.0	0 to 2,5	100	G 1/2
102263	954	1.0	0 to 4	100	G 1/2
102264	955	1.0	0 to 6	100	G 1/2
102265	956	1.0	0 to 10	100	G 1/2
102266	957	1.0	0 to 16	100	G 1/2
102267	958	1.0	0 to 25	100	G 1/2
102268	959	1.0	0 to 40	100	G 1/2
102269	960	1.0	0 to 60	100	G 1/2
102270	961	1.0	0 to 100	100	G 1/2
102271	962	1.0	0 to 160	100	G 1/2
102272	963	1.0	0 to 250	100	G 1/2
102273	964	1.0	0 to 400	100	G 1/2
102274	965	1.0	0 to 600	100	G 1/2

Glycerine-filled pressure gauges

panel-mounting type with clamp fixing and hot-pressed brass housing, single scale in bar

MAX

Bourdon-tube pressure gauge in standard design, with clamp fixing.

For measurements in areas with high, dynamic pressure loads and vibration levels.
Suitable for gaseous or liquid media which do not corrode copper alloy,
do not have high viscosity and do not crystallise.

Type	213.40
Housing	Hot-pressed brass
Measuring element	Copper alloy
Movement	Copper alloy
Front glass	Plexiglass
Medium temperature	-20 to 60 °C
Ambient temperature	-20 to 60 °C

Glycerine-filled pressure gauge with clamp fixing and 3-hole bezel, connection on rear, Ø 63 = central, Ø 100 = excentrical

Art. No.	Type No.	Accuracy class	Measuring range bar	Diameter mm	Connection
102275	1000	1.6	-1 to 0	63	G 1/4
102276	1000/1	1.6	-1 to 1,5	63	G 1/4
102277	1000/2	1.6	-1 to 3	63	G 1/4
102278	1000/3	1.6	-1 to 5	63	G 1/4
102279	1002	1.6	0 to 1,6	63	G 1/4
102280	1003	1.6	0 to 2,5	63	G 1/4
102281	1004	1.6	0 to 4	63	G 1/4
102282	1005	1.6	0 to 6	63	G 1/4
102283	1006	1.6	0 to 10	63	G 1/4
102284	1007	1.6	0 to 16	63	G 1/4
102285	1008	1.6	0 to 25	63	G 1/4
102286	1009	1.6	0 to 40	63	G 1/4
102287	1010	1.6	0 to 60	63	G 1/4
102288	1011	1.6	0 to 100	63	G 1/4
102289	1012	1.6	0 to 160	63	G 1/4
102290	1013	1.6	0 to 250	63	G 1/4
102291	1014	1.6	0 to 400	63	G 1/4
102292	1015	1.6	0 to 600	63	G 1/4
102293	1020	1.0	-1 to 0	100	G 1/2
102294	1022	1.0	0 to 1,6	100	G 1/2
102295	1023	1.0	0 to 2,5	100	G 1/2
102296	1024	1.0	0 to 4	100	G 1/2
102297	1025	1.0	0 to 6	100	G 1/2
102298	1026	1.0	0 to 10	100	G 1/2
102299	1027	1.0	0 to 16	100	G 1/2
102300	1028	1.0	0 to 25	100	G 1/2
102301	1029	1.0	0 to 40	100	G 1/2
102302	1030	1.0	0 to 60	100	G 1/2
102303	1031	1.0	0 to 100	100	G 1/2
102304	1032	1.0	0 to 160	100	G 1/2
102305	1033	1.0	0 to 250	100	G 1/2
102306	1034	1.0	0 to 400	100	G 1/2
102307	1035	1.0	0 to 600	100	G 1/2



1004



Pressure gauges

robust type

MAX

Robust bourdon-tube pressure gauge.

Suitable for gaseous or liquid media which do not corrode copper alloy, do not have high viscosity and do not crystallise.

Type	212.20
Accuracy class	1.0
Housing	CrNi steel
Movement	Copper alloy
Front glass	Flat instrument glass
Medium temperature	-40 to 80 °C
Ambient temperature	-40 to 60 °C



508

Robust pressure gauge, connection radial on bottom

Art. No.	Type No.	Measuring element	Measuring range bar	Diameter mm	Connection
102016	500	Copper alloy	-1 to 0	100	G 1/2
102017	500/1	Copper alloy	-1 to 1,5	100	G 1/2
102018	500/2	Copper alloy	-1 to 3	100	G 1/2
102019	500/3	Copper alloy	-1 to 5	100	G 1/2
102020	500/4	Copper alloy	-1 to 9	100	G 1/2
102021	500/5	Copper alloy	-1 to 15	100	G 1/2
102022	501	Copper alloy	0 to 0,6	100	G 1/2
102023	502	Copper alloy	0 to 1	100	G 1/2
102024	503	Copper alloy	0 to 1,6	100	G 1/2
102025	504	Copper alloy	0 to 2,5	100	G 1/2
102026	505	Copper alloy	0 to 4	100	G 1/2
102027	506	Copper alloy	0 to 6	100	G 1/2
102028	507	Copper alloy	0 to 10	100	G 1/2
102029	508	Copper alloy	0 to 16	100	G 1/2
102030	509	Copper alloy	0 to 25	100	G 1/2
102031	510	Copper alloy	0 to 40	100	G 1/2
102032	511	Copper alloy	0 to 60	100	G 1/2
102033	512	CrNi steel	0 to 100	100	G 1/2
102034	513	CrNi steel	0 to 160	100	G 1/2
102035	514	CrNi steel	0 to 250	100	G 1/2
102036	515	CrNi steel	0 to 400	100	G 1/2
102037	516	CrNi steel	0 to 600	100	G 1/2
102038	517	CrNi steel	0 to 1000	100	G 1/2
102039	520	Copper alloy	-1 to 0	160	G 1/2
102040	521	Copper alloy	0 to 0,6	160	G 1/2
102041	522	Copper alloy	0 to 1	160	G 1/2
102042	523	Copper alloy	0 to 1,6	160	G 1/2
102043	524	Copper alloy	0 to 2,5	160	G 1/2
102044	525	Copper alloy	0 to 4	160	G 1/2
102045	526	Copper alloy	0 to 6	160	G 1/2
102046	527	Copper alloy	0 to 10	160	G 1/2
102047	528	Copper alloy	0 to 16	160	G 1/2
102048	529	Copper alloy	0 to 25	160	G 1/2
102049	530	Copper alloy	0 to 40	160	G 1/2
102050	531	Copper alloy	0 to 60	160	G 1/2
102051	532	CrNi steel	0 to 100	160	G 1/2
102052	533	CrNi steel	0 to 160	160	G 1/2
102053	534	CrNi steel	0 to 250	160	G 1/2
102054	535	CrNi steel	0 to 400	160	G 1/2
102055	536	CrNi steel	0 to 600	160	G 1/2

Pressure gauges

robust type

MAX

Robust pressure gauge, connection on rear, excentrical

Art. No.	Type No.	Measuring element	Measuring range bar	Diameter mm	Connection
102056	600	Copper alloy	-1 to 0	100	G 1/2
102057	601	Copper alloy	0 to 1	100	G 1/2
102058	602	Copper alloy	0 to 1,6	100	G 1/2
102059	603	Copper alloy	0 to 2,5	100	G 1/2
102060	604	Copper alloy	0 to 4	100	G 1/2
102061	605	Copper alloy	0 to 6	100	G 1/2
102062	606	Copper alloy	0 to 10	100	G 1/2
102063	607	Copper alloy	0 to 16	100	G 1/2
102064	608	Copper alloy	0 to 25	100	G 1/2
102065	609	Copper alloy	0 to 40	100	G 1/2
102066	612	CrNi steel	0 to 160	100	G 1/2
102067	613	CrNi steel	0 to 250	100	G 1/2



613



- Version for panel mounting available on request
- Version with max. pointer available on request

Pressure gauges

for welding applications



Bourdon-tube pressure gauge acc. to EN 562.

For welding systems and cutting machines or similar processes.

Type	111.11
Accuracy class	2.5
Housing	Steel, brass-coloured, pressure relief in the rear wall
Measuring element	Copper alloy
Movement	Copper alloy
Front glass	Polycarbonate
Medium temperature	-20 to 60 °C
Ambient temperature	-20 to 60 °C

Pressure gauge for welding applications, connection radial on bottom

Art. No.	Type No.	Measuring range bar	Marking	Diameter mm	Connection
101297	401	0 to 16	oxygen	63	G 1/4
101298	404	0 to 315	oxygen	63	G 1/4
101299	411	0 to 2,5	acetylene	63	G 1/4
101300	413	0 to 40	acetylene	63	G 1/4



404

NEW Capsule-type Pressure gauges

for measuring pressure in millibars

PLUS

10 times overload-safe FSD, with zero correction.

Applications	For gaseous, dry, non-corrosive media
Accuracy class	1.6
Measuring element	Copper alloy
Movement	Brass
Max. medium temperature	60 °C
Ambient temperature	-20 to 60 °C



5844-R

Capsule-type pressure gauge, overpressure safety 10x FSD, connection radial on bottom

Art. No.	Type No.	Housing	Front glass	Measuring range mbar	Diameter mm	Connection
199270	5840-R	CrNi steel	Instrument glass	0 - 40	63	G 1/4
199271	5841-R	CrNi steel	Instrument glass	0 - 60	63	G 1/4
199272	5842-R	CrNi steel	Instrument glass	0 - 100	63	G 1/4
199273	5843-R	CrNi steel	Instrument glass	0 - 160	63	G 1/4
199274	5844-R	CrNi steel	Instrument glass	0 - 250	63	G 1/4
199275	6840-R	CrNi steel	Instrument glass	0 - 40	100	G 1/2
199276	6841-R	CrNi steel	Instrument glass	0 - 60	100	G 1/2
199277	6842-R	CrNi steel	Instrument glass	0 - 100	100	G 1/2
199278	6843-R	CrNi steel	Instrument glass	0 - 160	100	G 1/2
199279	6844-R	CrNi steel	Instrument glass	0 - 250	100	G 1/2

NEW Capsule-type pressure gauges

for measuring pressure in millibars

PLUS

With zero correction.

Applications	For gaseous, dry, non-corrosive media
Accuracy class	1.6
Measuring element	Copper alloy
Movement	Brass
Max. medium temperature	60 °C
Ambient temperature	-20 to 60 °C



5814-R

Capsule-type pressure gauge, Housing steel, black, connection radial on bottom

Art. No.	Type No.	Housing	Front glass	Measuring range mbar	Diameter mm	Connection
199280	5801-R	Steel, black	Plastic, clipped in	-160 - 0	63	G 1/4
199281	5802-R	Steel, black	Plastic, clipped in	-100 - 0	63	G 1/4
199282	5803-R	Steel, black	Plastic, clipped in	-60 - 0	63	G 1/4
199283	5812-R	Steel, black	Plastic, clipped in	0 - 40	63	G 1/4
199284	5813-R	Steel, black	Plastic, clipped in	0 - 60	63	G 1/4
199285	5814-R	Steel, black	Plastic, clipped in	0 - 100	63	G 1/4
199286	5815-R	Steel, black	Plastic, clipped in	0 - 160	63	G 1/4
199287	5816-R	Steel, black	Plastic, clipped in	0 - 250	63	G 1/4
199288	5817-R	Steel, black	Plastic, clipped in	0 - 400	63	G 1/4

NEW Capsule-type pressure gauges

for measuring pressure in millibars

PLUS

Capsule-type pressure gauge, Housing CrNi steel, connection radial on bottom

Art. No.	Type No.	Housing	Front glass	Measuring range mbar	Diameter mm	Connection
199289	6801-R	CrNi steel	Instrument glass	-160 - 0	100	G 1/2
199290	6802-R	CrNi steel	Instrument glass	-100 - 0	100	G 1/2
199291	6803-R	CrNi steel	Instrument glass	-60 - 0	100	G 1/2
199292	6804-R	CrNi steel	Instrument glass	-25 - 15	100	G 1/2
199293	6805-R	CrNi steel	Instrument glass	-40 - 20	100	G 1/2
199294	6811-R	CrNi steel	Instrument glass	0 - 25	100	G 1/2
199295	6812-R	CrNi steel	Instrument glass	0 - 40	100	G 1/2
199296	6813-R	CrNi steel	Instrument glass	0 - 60	100	G 1/2
199297	6814-R	CrNi steel	Instrument glass	0 - 100	100	G 1/2
199298	6815-R	CrNi steel	Instrument glass	0 - 160	100	G 1/2
199299	6816-R	CrNi steel	Instrument glass	0 - 250	100	G 1/2
199300	6817-R	CrNi steel	Instrument glass	0 - 400	100	G 1/2



6816-R



Capsule-type pressure gauge, Housing steel, black, connection on rear, central

Art. No.	Type No.	Housing	Front glass	Measuring range mbar	Diameter mm	Connection
199301	5821-R	Steel, black	Plastic, clipped in	0 - 40	63	G 1/4
199302	5822-R	Steel, black	Plastic, clipped in	0 - 60	63	G 1/4
199303	5823-R	Steel, black	Plastic, clipped in	0 - 100	63	G 1/4
199304	5824-R	Steel, black	Plastic, clipped in	0 - 160	63	G 1/4
199305	5825-R	Steel, black	Plastic, clipped in	0 - 250	63	G 1/4
199306	5826-R	Steel, black	Plastic, clipped in	0 - 400	63	G 1/4



5823-R

Capsule-type pressure gauge, Housing CrNi steel, connection on rear, central

Art. No.	Type No.	Housing	Front glass	Measuring range mbar	Diameter mm	Connection
199307	6820-R	CrNi steel	Instrument glass	0 - 25	100	G 1/2
199308	6821-R	CrNi steel	Instrument glass	0 - 40	100	G 1/2
199309	6822-R	CrNi steel	Instrument glass	0 - 60	100	G 1/2
199310	6823-R	CrNi steel	Instrument glass	0 - 100	100	G 1/2
199311	6824-R	CrNi steel	Instrument glass	0 - 160	100	G 1/2
199312	6825-R	CrNi steel	Instrument glass	0 - 250	100	G 1/2
199313	6826-R	CrNi steel	Instrument glass	0 - 400	100	G 1/2



6825-R

Capsule-type pressure gauges

for measuring pressure in millibars

MAX

Overpressure safety 10x FSD, with zero correction.

Applications	For gaseous, dry, non-corrosive media
Accuracy class	1.6
Measuring element	Copper alloy
Movement	Copper alloy
Medium temperature	-20 to 100 °C
Ambient temperature	-20 to 60 °C



6841

Capsule-type pressure gauge, overpressure safety 10x FSD, connection radial on bottom

Art. No.	Type No.	Type	Housing	Front glass	Measuring range mbar	Diameter mm	Connection
102517	5840	611.10	Steel, black	PMMA	0 - 40	63	G 1/4
102518	5841	611.10	Steel, black	PMMA	0 - 60	63	G 1/4
102519	5842	611.10	Steel, black	PMMA	0 - 100	63	G 1/4
102520	5843	611.10	Steel, black	PMMA	0 - 160	63	G 1/4
102521	5844	611.10	Steel, black	PMMA	0 - 250	63	G 1/4
102522	6840	612.20	CrNi steel	PMMA	0 - 40	100	G 1/2
102523	6841	612.20	CrNi steel	PMMA	0 - 60	100	G 1/2
102524	6842	612.20	CrNi steel	PMMA	0 - 100	100	G 1/2
102525	6843	612.20	CrNi steel	PMMA	0 - 160	100	G 1/2
102526	6844	612.20	CrNi steel	PMMA	0 - 250	100	G 1/2

Capsule-type pressure gauges

for measuring pressure in millibars

MAX

With zero correction.

Applications	For gaseous, dry, non-corrosive media
Accuracy class	1.6
Measuring element	Copper alloy
Movement	Copper alloy
Ambient temperature	-20 to 60 °C



6814

Capsule-type pressure gauge, connection radial on bottom

Art. No.	Type No.	Medium temperature °C	Type	Housing	Front glass	Measuring range mbar	Diameter mm	Connection
102527	5801	-20 to 100	611.10	Steel	PMMA	-160 - 0	63	G 1/4
102528	5802	-20 to 100	611.10	Steel	PMMA	-100 - 0	63	G 1/4
102529	5803	-20 to 100	611.10	Steel	PMMA	-60 - 0	63	G 1/4
102530	5812	-20 to 100	611.10	Steel	PMMA	0 - 40	63	G 1/4
102531	5813	-20 to 100	611.10	Steel	PMMA	0 - 60	63	G 1/4
102532	5814	-20 to 100	611.10	Steel	PMMA	0 - 100	63	G 1/4
102533	5815	-20 to 100	611.10	Steel	PMMA	0 - 160	63	G 1/4
102534	5816	-20 to 100	611.10	Steel	PMMA	0 - 250	63	G 1/4
102535	5817	-20 to 100	611.10	Steel	PMMA	0 - 400	63	G 1/4
102536	6801	-20 to 100	612.20	CrNi steel	Glass	-160 - 0	100	G 1/2
102537	6802	-20 to 100	612.20	CrNi steel	Glass	-100 - 0	100	G 1/2
102538	6803	-20 to 100	612.20	CrNi steel	Glass	-60 - 0	100	G 1/2
102539	6804	-20 to 100	612.20	CrNi steel	Glass	-25 - 15	100	G 1/2
102540	6805	-20 to 100	612.20	CrNi steel	Glass	-40 - 20	100	G 1/2
102541	6811	-20 to 100	612.20	CrNi steel	Glass	0 - 25	100	G 1/2
102542	6812	-20 to 100	612.20	CrNi steel	Glass	0 - 40	100	G 1/2

Capsule-type pressure gauges

for measuring pressure in millibars

MAX |||

Capsule-type pressure gauge, connection radial on bottom

Art. No.	Type No.	Medium temperature °C	Type	Housing	Front glass	Measuring range mbar	Diameter mm	Connection
102543	6813	-20 to 100	612.20	CrNi steel	Glass	0 - 60	100	G 1/2
102544	6814	-20 to 100	612.20	CrNi steel	Glass	0 - 100	100	G 1/2
102545	6815	-20 to 100	612.20	CrNi steel	Glass	0 - 160	100	G 1/2
102546	6816	-20 to 100	612.20	CrNi steel	Glass	0 - 250	100	G 1/2
102547	6817	-20 to 100	612.20	CrNi steel	Glass	0 - 400	100	G 1/2

Capsule-type pressure gauge, connection on rear, Ø 63 = central, Ø 100 = excentral

Art. No.	Type No.	Medium temperature °C	Type	Housing	Front glass	Measuring range mbar	Diameter mm	Connection
102548	5821	-20 to 100	611.10	Steel	PMMA	0 - 40	63	G 1/4
102549	5822	-20 to 100	611.10	Steel	PMMA	0 - 60	63	G 1/4
102550	5823	-20 to 100	611.10	Steel	PMMA	0 - 100	63	G 1/4
102551	5824	-20 to 100	611.10	Steel	PMMA	0 - 160	63	G 1/4
102552	5825	-20 to 100	611.10	Steel	PMMA	0 - 250	63	G 1/4
102553	5826	-20 to 100	611.10	Steel	PMMA	0 - 400	63	G 1/4
102554	6820	-20 to 80	612.20	CrNi steel	Glass	0 - 25	100	G 1/2
102555	6821	-20 to 80	612.20	CrNi steel	Glass	0 - 40	100	G 1/2
102556	6822	-20 to 80	612.20	CrNi steel	Glass	0 - 60	100	G 1/2
102557	6823	-20 to 80	612.20	CrNi steel	Glass	0 - 100	100	G 1/2
102558	6824	-20 to 80	612.20	CrNi steel	Glass	0 - 160	100	G 1/2
102559	6825	-20 to 80	612.20	CrNi steel	Glass	0 - 250	100	G 1/2
102560	6826	-20 to 80	612.20	CrNi steel	Glass	0 - 400	100	G 1/2



5823



NEW Precision pressure gauges

PLUS

Bourdon-tube pressure gauge for precision measurements.

for gaseous, liquid, not highly viscous and non-crystallising media which do not attack copper alloys.

Accuracy class	0.6
Housing	CrNi steel
Bezel	CrNi steel
Movement	Brass
Front glass	Plastic (PMMA)
Max. medium temperature	60 °C
Ambient temperature	-20 to 60 °C



1165-R

Precision pressure gauge, Medium temperature max. 60 °C

Art. No.	Type No.	Measuring element	Measuring range bar	Scale graduation in the bar area bar	Diameter mm	Connection
199314	1158-R	Copper alloy	-1 to 0	0.005	160	G 1/2
199315	1158/1-R	Copper alloy	-1 to 0,6	0.01	160	G 1/2
199316	1158/2-R	Copper alloy	-1 to 1,5	0.02	160	G 1/2
199317	1159-R	Copper alloy	0 to 0,6	0.005	160	G 1/2
199318	1160-R	Copper alloy	0 to 1	0.005	160	G 1/2
199319	1161-R	Copper alloy	0 to 1,6	0.01	160	G 1/2
199320	1162-R	Copper alloy	0 to 2,5	0.02	160	G 1/2
199321	1163-R	Copper alloy	0 to 4	0.02	160	G 1/2
199322	1164-R	Copper alloy	0 to 6	0.05	160	G 1/2
199323	1165-R	Copper alloy	0 to 10	0.05	160	G 1/2
199324	1166-R	Copper alloy	0 to 16	0.1	160	G 1/2
199325	1167-R	Copper alloy	0 to 25	0.2	160	G 1/2
199326	1168-R	Copper alloy	0 to 40	0.2	160	G 1/2
199327	1169-R	Copper alloy	0 to 60	0.5	160	G 1/2
199328	1171-R	CrNi steel	0 to 160	1	160	G 1/2
199329	1172-R	CrNi steel	0 to 250	2	160	G 1/2
199330	1173-R	CrNi steel	0 to 400	2	160	G 1/2

Precision pressure gauges

MAX

Bourdon-tube pressure gauge for precision measurements.

Suitable for gaseous or liquid media which do not corrode copper alloy, do not have high viscosity and do not crystallise.

Type	312.20
Accuracy class	0.6
Housing	CrNi steel
Bezel	CrNi steel
Movement	Copper alloy
Front glass	Flat instrument glass
Medium temperature	-20 to 80 °C
Ambient temperature	-20 to 60 °C

Precision pressure gauges, Medium temperature max. 80 °C

Art. No.	Type No.	Measuring element	Measuring range bar	Scale graduation in the bar area bar	Diameter mm	Connection
102561	1158	Copper alloy	-1 to 0	0.005	160	G 1/2
102562	1158/1	Copper alloy	-1 to 0,6	0.01	160	G 1/2
102563	1158/2	Copper alloy	-1 to 1,5	0.02	160	G 1/2
102564	1159	Copper alloy	0 to 0,6	0.005	160	G 1/2
102565	1160	Copper alloy	0 to 1	0.005	160	G 1/2
102566	1161	Copper alloy	0 to 1,6	0.01	160	G 1/2
102567	1162	Copper alloy	0 to 2,5	0.02	160	G 1/2
102568	1163	Copper alloy	0 to 4	0.02	160	G 1/2
102569	1164	Copper alloy	0 to 6	0.05	160	G 1/2
102570	1165	Copper alloy	0 to 10	0.05	160	G 1/2
102571	1166	Copper alloy	0 to 16	0.1	160	G 1/2
102572	1167	Copper alloy	0 to 25	0.2	160	G 1/2
102573	1168	Copper alloy	0 to 40	0.2	160	G 1/2
102574	1169	Copper alloy	0 to 60	0.5	160	G 1/2
102575	1171	CrNi steel	0 to 160	1	160	G 1/2
102576	1172	CrNi steel	0 to 250	2	160	G 1/2
102577	1173	CrNi steel	0 to 400	2	160	G 1/2



1163



NEW Differential pressure gauges

with parallel male connector

PLUS

Bourdon-tube pressure gauge with parallel male connector and two separate measuring systems.

For measuring differential pressures or two different pressures.

For gaseous, liquid, not highly viscous and non-crystallising media which do not attack copper alloys.

Accuracy class	1.6
Housing	Steel, black
Bezel	steel, black
Movement	Brass
Front glass	Instrument glass
Max. medium temperature	60 °C
Ambient temperature	-20 to 60 °C



1206-R

Differential pressure gauge, two connections radial on bottom

Art. No.	Type No.	Measuring range bar	Diameter mm	Connection
199331	1201-R	0 to 1	100	G 1/2
199332	1202-R	0 to 1,6	100	G 1/2
199333	1203-R	0 to 2,5	100	G 1/2
199334	1204-R	0 to 4	100	G 1/2
199335	1205-R	0 to 6	100	G 1/2
199336	1206-R	0 to 10	100	G 1/2

Differential pressure gauges

with parallel male connector

MAX

Bourdon-tube pressure gauge with parallel male connector and two separate measuring systems.

For measuring differential pressures or two different pressures.

Suitable for gaseous or liquid media which do not corrode copper alloy, do not have high viscosity and do not crystallise.

Accuracy class	1.6
Housing	Steel, black
Bezel	Steel, black
Movement	Copper alloy
Front glass	Flat instrument glass
Medium temperature	-20 to 60 °C
Ambient temperature	-20 to 60 °C



1205

Differential pressure gauge, two connections radial on bottom

Art. No.	Type No.	Measuring range bar	Diameter mm	Connection
102578	1201	0 to 1	100	G 1/2
102579	1202	0 to 1,6	100	G 1/2
102580	1203	0 to 2,5	100	G 1/2
102581	1204	0 to 4	100	G 1/2
102582	1205	0 to 6	100	G 1/2
102583	1206	0 to 10	100	G 1/2

Contact pressure gauges

with magnetic spring contact 821.21

MAX

Robust bourdon-tube pressure gauge with electrical contact (magnetic spring contact), contact type 821.21. The electrical contact opens an electrical circuit when the first set limit value is reached and closes it again at the second limit value.

Suitable for gaseous or liquid media which do not corrode copper alloy, do not have high viscosity and do not crystallise.

Current ratings: Make rating 1.0, ABreak rating 1.0, AContinuous load 0.6 A

Pin assignment 821.21:

1. Contact makes when pointer reaches set point
2. Contact breaks when pointer reaches set point

Type	PGS21
Housing	CrNi steel 1.4301
Bezel	CrNi steel 1.4301
Movement	Copper alloy
Front glass	Polycarbonate
Medium temperature	-20 to 80 °C
Ambient temperature	-20 to 60 °C
Rated operating voltage (MSR) Ueff max.	250 V
Switching capacity max.	30 W / 50 VA



Contact pressure gauge, connection radial on bottom

Art. No.	Type No.	Accuracy class	Measuring element	Measuring range bar	Diameter mm	Connection
102595	2201	1.0	Copper alloy	0 to 2,5	100	G 1/2
102596	2202	1.0	Copper alloy	0 to 4	100	G 1/2
102597	2203	1.0	Copper alloy	0 to 6	100	G 1/2
102598	2204	1.0	Copper alloy	0 to 10	100	G 1/2
102599	2205	1.0	Copper alloy	0 to 16	100	G 1/2
102600	2206	1.0	Copper alloy	0 to 25	100	G 1/2
102601	2207	1.0	Copper alloy	0 to 40	100	G 1/2
102602	2208	1.0	Copper alloy	0 to 60	100	G 1/2
102603	2209	1.0	CrNi steel 1.4571	0 to 100	100	G 1/2
102604	2210	1.0	CrNi steel 1.4571	0 to 160	100	G 1/2
102605	2211	1.0	CrNi steel 1.4571	0 to 250	100	G 1/2
102606	2212	1.0	CrNi steel 1.4571	0 to 400	100	G 1/2
102607	3300	2.5	Copper alloy	-1 to 0	160	G 1/2
102608	3300/1	1.0	Copper alloy	-1 to 1,5	160	G 1/2
102609	3301	2.5	Copper alloy	0 to 1	160	G 1/2
102610	3303	1.0	Copper alloy	0 to 6	160	G 1/2
102611	3304	1.0	Copper alloy	0 to 10	160	G 1/2
102612	3305	1.0	Copper alloy	0 to 16	160	G 1/2
102613	3307	1.0	Copper alloy	0 to 40	160	G 1/2
102614	3313	1.0	CrNi steel 1.4571	0 to 600	160	G 1/2



3305

- ➔ Other instrument variants (other magnetic spring contacts, sliding contacts or inductive contacts) available on request
- ➔ Contact pressure gauges completely made of stainless steel can be found in our online shop.

Diaphragm pressure gauges



Diaphragm pressure gauge in robust design or for chemical applications.

Suitable for gaseous or liquid media, chemical applications type also suitable for use in corrosive atmosphere.

Accuracy class	1.6
Measuring element	CrNi steel
Measuring flange diameter	100 mm
Medium temperature	-20 to 100 °C
Ambient temperature	-20 to 60 °C



PL 1918



PL 2107

Robust diaphragm pressure gauge, connection radial on bottom

Art. No.	Type No.	Type	Housing	Measuring range bar	Diameter mm	Connection
102584	PL 1901	422.12	Grey cast iron, black	-1 to 1,5	100	G 1/2
102585	PL 1911	422.12	Grey cast iron, black	0 to 1	100	G 1/2
102586	PL 1912	422.12	Grey cast iron, black	0 to 1,6	100	G 1/2
102587	PL 1913	422.12	Grey cast iron, black	0 to 2,5	100	G 1/2
102588	PL 1914	422.12	Grey cast iron, black	0 to 4	100	G 1/2
102589	PL 1915	422.12	Grey cast iron, black	0 to 6	100	G 1/2
102590	PL 1916	422.12	Grey cast iron, black	0 to 10	100	G 1/2
102591	PL 1917	422.12	Grey cast iron, black	0 to 16	100	G 1/2
102592	PL 1918	422.12	Grey cast iron, black	0 to 25	100	G 1/2

Diaphragm pressure gauge for chemical applications, connection radial on bottom

Art. No.	Type No.	Type	Housing	Measuring range bar	Diameter mm	Connection
102593	PL 2106	432.50	CrNi steel	0 to 6	100	G 1/2
102594	PL 2107	432.50	CrNi steel	0 to 10	100	G 1/2

Pressure gauges

CrNi steel type with dual scale in bar/psi

Bourdon-tube pressure gauge (standard model) manufactured entirely from CrNi steel, economical and reliable.

Suitable for gaseous or liquid, corrosive and crystallising media which do not have high viscosity, also in corrosive atmosphere. Clean dry air applications, machinery and industrial plant engineering in general.

Type	131.11
Accuracy class	2.5
Material	CrNi steel
Front glass	Polycarbonate
Medium temperature	-40 to 100 °C
Ambient temperature	-40 to 60 °C

Pressure gauge, CrNi steel, standard type, connection radial on bottom

Art. No.	Type No.	Measuring range bar	Measuring range psi	Diameter mm	Connection
102406	4101	0 to 1	0 - 14,5	40	G 1/4
102407	4102	0 to 1,6	0 - 23	40	G 1/4
102408	4103	0 to 2,5	0 - 36	40	G 1/4
102409	4104	0 to 4	0 - 58	40	G 1/4
102410	4105	0 to 6	0 - 86	40	G 1/4
102411	4106	0 to 10	0 - 145	40	G 1/4
102412	4107	0 to 16	0 - 230	40	G 1/4
102413	4108	0 to 25	0 - 360	40	G 1/4
102414	4109	0 to 40	0 - 580	40	G 1/4
102415	4110	0 to 60	0 - 860	40	G 1/4
102416	4111	0 to 100	0 - 1450	40	G 1/4
102417	4121	0 to 1	0 - 14,5	50	G 1/4
102418	4122	0 to 1,6	0 - 23	50	G 1/4
102419	4123	0 to 2,5	0 - 36	50	G 1/4
102420	4124	0 to 4	0 - 58	50	G 1/4
102421	4125	0 to 6	0 - 86	50	G 1/4
102422	4126	0 to 10	0 - 145	50	G 1/4
102423	4127	0 to 16	0 - 230	50	G 1/4
102424	4128	0 to 25	0 - 360	50	G 1/4
102425	4129	0 to 40	0 - 580	50	G 1/4
102426	4130	0 to 60	0 - 860	50	G 1/4
102427	4131	0 to 100	0 - 1450	50	G 1/4



4126

Pressure gauge, CrNi steel, standard type, connection on rear, central

Art. No.	Type No.	Measuring range bar	Measuring range psi	Diameter mm	Connection
102428	4141	0 to 1	0 - 14,5	40	G 1/4
102429	4142	0 to 1,6	0 - 23	40	G 1/4
102430	4143	0 to 2,5	0 - 36	40	G 1/4
102431	4144	0 to 4	0 - 58	40	G 1/4
102432	4145	0 to 6	0 - 86	40	G 1/4
102433	4146	0 to 10	0 - 145	40	G 1/4
102434	4147	0 to 16	0 - 230	40	G 1/4
102435	4148	0 to 25	0 - 360	40	G 1/4
102436	4149	0 to 40	0 - 580	40	G 1/4
102437	4150	0 to 60	0 - 860	40	G 1/4
102438	4151	0 to 100	0 - 1450	40	G 1/4
102439	4161	0 to 1	0 - 14,5	50	G 1/4
102440	4162	0 to 1,6	0 - 23	50	G 1/4
102441	4163	0 to 2,5	0 - 36	50	G 1/4
102442	4164	0 to 4	0 - 58	50	G 1/4
102443	4165	0 to 6	0 - 86	50	G 1/4
102444	4166	0 to 10	0 - 145	50	G 1/4



4146

Pressure gauges

CrNi steel type with dual scale in bar/psi

Pressure gauge, CrNi steel, standard type, connection radial on bottom

Art. No.	Type No.	Measuring range bar	Measuring range psi	Diameter mm	Connection
102445	4167	0 to 16	0 - 230	50	G 1/4
102446	4168	0 to 25	0 - 360	50	G 1/4
102447	4169	0 to 40	0 - 580	50	G 1/4
102448	4170	0 to 60	0 - 860	50	G 1/4
102449	4171	0 to 100	0 - 1450	50	G 1/4

Pressure gauges

CrNi steel type with single scale in bar

Bourdon-tube pressure gauge, CrNi steel type, all stainless steel.

Suitable for gaseous or liquid media which do not have high viscosity and do not crystallise, also in corrosive atmosphere.

Type	232.50
Material	CrNi steel
Medium temperature	-40 to 200 °C
Ambient temperature	-40 to 60 °C



4033

Pressure gauge, CrNi steel type, connection radial on bottom

Art. No.	Type No.	Accuracy class	Front glass	Measuring range bar	Diameter mm	Connection
102475	4001	1.6	Polycarbonate	-1 to 0	63	G 1/4
102476	4002	1.6	Polycarbonate	0 to 2,5	63	G 1/4
102477	4003	1.6	Polycarbonate	0 to 4	63	G 1/4
102478	4004	1.6	Polycarbonate	0 to 6	63	G 1/4
102479	4005	1.6	Polycarbonate	0 to 10	63	G 1/4
102480	4006	1.6	Polycarbonate	0 to 16	63	G 1/4
102481	4007	1.6	Polycarbonate	0 to 25	63	G 1/4
102482	4008	1.6	Polycarbonate	0 to 40	63	G 1/4
102483	4009	1.6	Polycarbonate	0 to 100	63	G 1/4
102484	4022	1.0	Laminated safety glass	-1 to 0	100	G 1/2
102485	4023	1.0	Laminated safety glass	-1 to 0,6	100	G 1/2
102486	4024	1.0	Laminated safety glass	-1 to 1,5	100	G 1/2
102487	4025	1.0	Laminated safety glass	-1 to 3	100	G 1/2
102488	4026	1.0	Laminated safety glass	-1 to 5	100	G 1/2
102489	4027	1.0	Laminated safety glass	-1 to 9	100	G 1/2
102490	4028	1.0	Laminated safety glass	-1 to 15	100	G 1/2
102491	4030	1.0	Laminated safety glass	0 to 1	100	G 1/2
102492	4030/1	1.0	Laminated safety glass	0 to 1,6	100	G 1/2
102493	4030/2	1.0	Laminated safety glass	0 to 2,5	100	G 1/2
102494	4031	1.0	Laminated safety glass	0 to 4	100	G 1/2
102495	4032	1.0	Laminated safety glass	0 to 6	100	G 1/2
102496	4033	1.0	Laminated safety glass	0 to 10	100	G 1/2
102497	4034	1.0	Laminated safety glass	0 to 16	100	G 1/2
102498	4035	1.0	Laminated safety glass	0 to 25	100	G 1/2
102499	4036	1.0	Laminated safety glass	0 to 40	100	G 1/2
102500	4037	1.0	Laminated safety glass	0 to 60	100	G 1/2

Pressure gauges

CrNi steel type with single scale in bar

Pressure gauge, CrNi steel type, connection radial on bottom						
Art. No.	Type No.	Accuracy class	Front glass	Measuring range bar	Diameter mm	Connection
102501	4012	1.0	Laminated safety glass	-1 to 0	160	G 1/2
102502	4013	1.0	Laminated safety glass	-1 to 0,6	160	G 1/2
102503	4050	1.0	Laminated safety glass	0 to 1	160	G 1/2
102504	4053	1.0	Laminated safety glass	0 to 10	160	G 1/2
102505	4054	1.0	Laminated safety glass	0 to 16	160	G 1/2
102506	4055	1.0	Laminated safety glass	0 to 25	160	G 1/2

Pressure gauges

CrNi steel type with single scale in bar

Bourdon-tube pressure gauge, CrNi steel type, all stainless steel.

Suitable for gaseous or liquid media which do not have high viscosity and do not crystallise, also in corrosive atmosphere.

Type	232.50
Material	CrNi steel
Medium temperature	-40 to 200 °C
Ambient temperature	-40 to 60 °C

Pressure gauge, CrNi steel type, connection on rear, Ø 63 = central, Ø 100 = excentral						
Art. No.	Type No.	Accuracy class	Front glass	Measuring range bar	Diameter mm	Connection
102507	4080	1.6	Polycarbonate	-1 to 0	63	G 1/4
102508	4081	1.6	Polycarbonate	0 to 2,5	63	G 1/4
102509	4082	1.6	Polycarbonate	0 to 4	63	G 1/4
102510	4083	1.6	Polycarbonate	0 to 6	63	G 1/4
101201	4084	1.6	Polycarbonate	0 to 10	63	G 1/4
101202	4085	1.6	Polycarbonate	0 to 16	63	G 1/4
102511	4086	1.6	Polycarbonate	0 to 25	63	G 1/4
102512	4087	1.6	Polycarbonate	0 to 40	63	G 1/4
102513	4089	1.6	Polycarbonate	0 to 100	63	G 1/4
102514	4090	1.6	Polycarbonate	0 to 250	63	G 1/4
131496	4091	1.0	Laminated safety glass	-1 to 0	100	G 1/2
134040	4091/1	1.0	Laminated safety glass	0 to 2,5	100	G 1/2
118691	4092	1.0	Laminated safety glass	0 to 4	100	G 1/2
102515	4093	1.0	Laminated safety glass	0 to 6	100	G 1/2
102516	4094	1.0	Laminated safety glass	0 to 10	100	G 1/2
134042	4095	1.0	Laminated safety glass	0 to 16	100	G 1/2
134043	4096	1.0	Laminated safety glass	0 to 25	100	G 1/2
134044	4097	1.0	Laminated safety glass	0 to 40	100	G 1/2



4084



Pressure gauges

CrNi steel type with single scale in bar

Bourdon-tube pressure gauge (safety housing), CrNi steel type, with solid baffle wall and blow-out (safety housing).

Suitable for gaseous or liquid, corrosive and crystallising media which do not have high viscosity, also in corrosive atmosphere.

Type	232.30
Material	CrNi steel
Medium temperature	-40 to 200 °C
Ambient temperature	-40 to 60 °C



5076

Pressure gauge, CrNi steel type (safety housing), connection radial on bottom

Art. No.	Type No.	Accuracy class	Front glass	Measuring range bar	Diameter mm	Connection
102450	5050	1.6	Polycarbonate	-1 to 0	63	G 1/4
102451	5053	1.6	Polycarbonate	0 to 1,6	63	G 1/4
102452	5054	1.6	Polycarbonate	0 to 2,5	63	G 1/4
102453	5055	1.6	Polycarbonate	0 to 4	63	G 1/4
102454	5056	1.6	Polycarbonate	0 to 6	63	G 1/4
102455	5057	1.6	Polycarbonate	0 to 10	63	G 1/4
102456	5058	1.6	Polycarbonate	0 to 16	63	G 1/4
102457	5059	1.6	Polycarbonate	0 to 25	63	G 1/4
102458	5060	1.6	Polycarbonate	0 to 40	63	G 1/4
102459	5061	1.6	Polycarbonate	0 to 60	63	G 1/4
102460	5062	1.6	Polycarbonate	0 to 100	63	G 1/4
102461	5072	1.0	Laminated safety glass	0 to 1	100	G 1/2
102462	5073	1.0	Laminated safety glass	0 to 1,6	100	G 1/2
102463	5074	1.0	Laminated safety glass	0 to 2,5	100	G 1/2
102464	5075	1.0	Laminated safety glass	0 to 4	100	G 1/2
102465	5076	1.0	Laminated safety glass	0 to 6	100	G 1/2
102466	5077	1.0	Laminated safety glass	0 to 10	100	G 1/2
102467	5078	1.0	Laminated safety glass	0 to 16	100	G 1/2
102468	5079	1.0	Laminated safety glass	0 to 25	100	G 1/2
102469	5080	1.0	Laminated safety glass	0 to 40	100	G 1/2
102470	5081	1.0	Laminated safety glass	0 to 60	100	G 1/2
102471	5082	1.0	Laminated safety glass	0 to 100	100	G 1/2
102472	5083	1.0	Laminated safety glass	0 to 160	100	G 1/2
102473	5084	1.0	Laminated safety glass	0 to 250	100	G 1/2
102474	5085	1.0	Laminated safety glass	0 to 400	100	G 1/2

Glycerine-filled pressure gauges

CrNi steel type with single scale in bar

Glycerine-filled bourdon-tube pressure gauge, CrNi steel type.

For use in the chemical/petrochemical process industry, power stations, machinery and industrial plant engineering.

For measurements in areas with high, dynamic pressure loads and vibration levels. Suitable for gaseous or liquid, corrosive and crystallising media which do not have high viscosity, also in corrosive atmosphere.

Type	233.50
Material	CrNi steel
Medium temperature	-20 to 100 °C
Ambient temperature	-20 to 60 °C

Glycerine-filled pressure gauge, CrNi steel type, connection radial on bottom

Art. No.	Type No.	Accuracy class	Front glass	Measuring range bar	Diameter mm	Connection
102308	740-63	1.6	Polycarbonate	-1 to 0	63	G 1/4
102309	740/1-63	1.6	Polycarbonate	-1 to 0,6	63	G 1/4
102310	740/2-63	1.6	Polycarbonate	-1 to 1,5	63	G 1/4
102311	740/3-63	1.6	Polycarbonate	-1 to 3	63	G 1/4
102312	740/4-63	1.6	Polycarbonate	-1 to 5	63	G 1/4
102313	740/5-63	1.6	Polycarbonate	-1 to 9	63	G 1/4
102314	740/6-63	1.6	Polycarbonate	-1 to 15	63	G 1/4
102315	742-63	1.6	Polycarbonate	0 to 1	63	G 1/4
102316	743-63	1.6	Polycarbonate	0 to 1,6	63	G 1/4
102317	744-63	1.6	Polycarbonate	0 to 2,5	63	G 1/4
102318	745-63	1.6	Polycarbonate	0 to 4	63	G 1/4
102319	746-63	1.6	Polycarbonate	0 to 6	63	G 1/4
102320	747-63	1.6	Polycarbonate	0 to 10	63	G 1/4
102321	748-63	1.6	Polycarbonate	0 to 16	63	G 1/4
102322	749-63	1.6	Polycarbonate	0 to 25	63	G 1/4
102323	750-63	1.6	Polycarbonate	0 to 40	63	G 1/4
102324	751-63	1.6	Polycarbonate	0 to 60	63	G 1/4
102325	752-63	1.6	Polycarbonate	0 to 100	63	G 1/4
102326	753-63	1.6	Polycarbonate	0 to 160	63	G 1/4
102327	754-63	1.6	Polycarbonate	0 to 250	63	G 1/4
102328	755-63	1.6	Polycarbonate	0 to 400	63	G 1/4
102329	756-63	1.6	Polycarbonate	0 to 600	63	G 1/4
102330	740-100	1.0	Laminated safety glass	-1 to 0	100	G 1/2
102331	740/1-100	1.0	Laminated safety glass	-1 to 0,6	100	G 1/2
102332	740/2-100	1.0	Laminated safety glass	-1 to 1,5	100	G 1/2
102333	740/3-100	1.0	Laminated safety glass	-1 to 3	100	G 1/2
102334	740/4-100	1.0	Laminated safety glass	-1 to 5	100	G 1/2
102335	740/5-100	1.0	Laminated safety glass	-1 to 9	100	G 1/2
102336	740/6-100	1.0	Laminated safety glass	-1 to 15	100	G 1/2
102337	741-100	1.0	Laminated safety glass	0 to 0,6	100	G 1/2
102338	742-100	1.0	Laminated safety glass	0 to 1	100	G 1/2
102339	743-100	1.0	Laminated safety glass	0 to 1,6	100	G 1/2
102340	744-100	1.0	Laminated safety glass	0 to 2,5	100	G 1/2
102341	745-100	1.0	Laminated safety glass	0 to 4	100	G 1/2
102342	746-100	1.0	Laminated safety glass	0 to 6	100	G 1/2
102343	747-100	1.0	Laminated safety glass	0 to 10	100	G 1/2
102344	748-100	1.0	Laminated safety glass	0 to 16	100	G 1/2
102345	749-100	1.0	Laminated safety glass	0 to 25	100	G 1/2
102346	750-100	1.0	Laminated safety glass	0 to 40	100	G 1/2
102347	751-100	1.0	Laminated safety glass	0 to 60	100	G 1/2
102348	752-100	1.0	Laminated safety glass	0 to 100	100	G 1/2
102349	753-100	1.0	Laminated safety glass	0 to 160	100	G 1/2



747-100



Glycerine-filled pressure gauges

CrNi steel type with single scale in bar



747-100

Glycerine-filled pressure gauge, CrNi steel type, connection radial on bottom

Art. No.	Type No.	Accuracy class	Front glass	Measuring range bar	Diameter mm	Connection
102350	754-100	1.0	Laminated safety glass	0 to 250	100	G 1/2
102351	755-100	1.0	Laminated safety glass	0 to 400	100	G 1/2
102352	756-100	1.0	Laminated safety glass	0 to 600	100	G 1/2
102353	740	1.0	Laminated safety glass	-1 to 0	160	G 1/2
102354	740/1	1.0	Laminated safety glass	-1 to 0,6	160	G 1/2
102355	740/2	1.0	Laminated safety glass	-1 to 1,5	160	G 1/2
102356	740/3	1.0	Laminated safety glass	-1 to 3	160	G 1/2
102357	740/4	1.0	Laminated safety glass	-1 to 5	160	G 1/2
102358	740/5	1.0	Laminated safety glass	-1 to 9	160	G 1/2
102359	740/6	1.0	Laminated safety glass	-1 to 15	160	G 1/2
102360	741	1.0	Laminated safety glass	0 to 0,6	160	G 1/2
102361	742	1.0	Laminated safety glass	0 to 1	160	G 1/2
102362	743	1.0	Laminated safety glass	0 to 1,6	160	G 1/2
102363	744	1.0	Laminated safety glass	0 to 2,5	160	G 1/2
102364	745	1.0	Laminated safety glass	0 to 4	160	G 1/2
102365	746	1.0	Laminated safety glass	0 to 6	160	G 1/2
102366	747	1.0	Laminated safety glass	0 to 10	160	G 1/2
102367	748	1.0	Laminated safety glass	0 to 16	160	G 1/2
102368	749	1.0	Laminated safety glass	0 to 25	160	G 1/2
102369	750	1.0	Laminated safety glass	0 to 40	160	G 1/2
102370	751	1.0	Laminated safety glass	0 to 60	160	G 1/2
102371	752	1.0	Laminated safety glass	0 to 100	160	G 1/2
102372	753	1.0	Laminated safety glass	0 to 160	160	G 1/2
102373	754	1.0	Laminated safety glass	0 to 250	160	G 1/2
102374	755	1.0	Laminated safety glass	0 to 400	160	G 1/2
102375	756	1.0	Laminated safety glass	0 to 600	160	G 1/2

Glycerine-filled pressure gauges

CrNi steel type with single scale in bar

Glycerine-filled bourdon-tube pressure gauge, CrNi steel type.

For use in the chemical/petrochemical process industry, power stations, machinery and industrial plant engineering.

For measurements in areas with high, dynamic pressure loads and vibration levels.
Suitable for gaseous or liquid, corrosive and crystallising media which do not have high viscosity, also in corrosive atmosphere.

Type	233.50
Material	CrNi steel
Medium temperature	-20 to 100 °C
Ambient temperature	-20 to 60 °C

Glycerine-filled pressure gauge, CrNi steel type, connection on rear, Ø 63 = central, Ø 100 = excentral

Art. No.	Type No.	Accuracy class	Front glass	Measuring range bar	Diameter mm	Connection
134023	4180	1.6	Polycarbonate	-1 to 0	63	G 1/4
134024	4181	1.6	Polycarbonate	0 to 2,5	63	G 1/4
134025	4182	1.6	Polycarbonate	0 to 4	63	G 1/4
134026	4183	1.6	Polycarbonate	0 to 6	63	G 1/4
134027	4184	1.6	Polycarbonate	0 to 10	63	G 1/4
134028	4185	1.6	Polycarbonate	0 to 16	63	G 1/4
134029	4186	1.6	Polycarbonate	0 to 25	63	G 1/4
134030	4187	1.6	Polycarbonate	0 to 40	63	G 1/4
134031	4191	1.0	Laminated safety glass	-1 to 0	100	G 1/2
134032	4191/1	1.0	Laminated safety glass	0 to 2,5	100	G 1/2
134033	4192	1.0	Laminated safety glass	0 to 4	100	G 1/2
134034	4193	1.0	Laminated safety glass	0 to 6	100	G 1/2
134035	4194	1.0	Laminated safety glass	0 to 10	100	G 1/2
134036	4195	1.0	Laminated safety glass	0 to 16	100	G 1/2
134037	4196	1.0	Laminated safety glass	0 to 25	100	G 1/2
134038	4197	1.0	Laminated safety glass	0 to 40	100	G 1/2



4184



Glycerine-filled pressure gauges

CrNi-steel safety housing with solid baffle wall, single scale in bar

Glycerine-filled bourdon-tube pressure gauge, CrNi steel type, with solid baffle wall and blow-out (safety housing).

Suitable for gaseous or liquid, corrosive and crystallising media which do not have high viscosity, also in corrosive atmosphere.

Type	233.30
Material	CrNi steel
Medium temperature	-20 to 100 °C
Ambient temperature	-20 to 60 °C



5015

Glycerine-filled pressure gauge, CrNi steel type (safety housing), connection radial on bottom

Art. No.	Type No.	Accuracy class	Front glass	Measuring range bar	Diameter mm	Connection
102376	4909	1.6	Polycarbonate	-1 to 0	63	G 1/4
102377	4911	1.6	Polycarbonate	0 to 4	63	G 1/4
102378	4912	1.6	Polycarbonate	0 to 6	63	G 1/4
102379	4913	1.6	Polycarbonate	0 to 10	63	G 1/4
102380	4914	1.6	Polycarbonate	0 to 16	63	G 1/4
102381	4915	1.6	Polycarbonate	0 to 25	63	G 1/4
102382	4916	1.6	Polycarbonate	0 to 40	63	G 1/4
102383	4917	1.6	Polycarbonate	0 to 60	63	G 1/4
102384	4918	1.6	Polycarbonate	0 to 100	63	G 1/4
102385	4919	1.6	Polycarbonate	0 to 160	63	G 1/4
102386	4920	1.6	Polycarbonate	0 to 250	63	G 1/4
102387	4921	1.6	Polycarbonate	0 to 400	63	G 1/4
102388	5009	1.0	Laminated safety glass	-1 to 0	100	G 1/2
102389	5009/2	1.0	Laminated safety glass	-1 to 1,5	100	G 1/2
102390	5009/3	1.0	Laminated safety glass	-1 to 3	100	G 1/2
102391	5009/4	1.0	Laminated safety glass	-1 to 5	100	G 1/2
102392	5009/5	1.0	Laminated safety glass	-1 to 9	100	G 1/2
102393	5010/2	1.0	Laminated safety glass	0 to 2,5	100	G 1/2
102394	5011	1.0	Laminated safety glass	0 to 4	100	G 1/2
102395	5012	1.0	Laminated safety glass	0 to 6	100	G 1/2

Protective covers

Protective cover for connection radial on bottom or on rear

Art. No.	Type No.	Material	for pressure gauge Ø mm	Colour
101301	GS 30	Rubber	63	Red
101302	GS 31	Rubber	63	Blue
102615	GS 100	Rubber	100	Blue



GS 31

Profile seals for pressure gauge

Profile seal for pressure gauge

Art. No.	Type No.	Material	For thread
102616	257.01	Cu	G 1/8
102617	257.02 A	Alu	G 1/4
102618	257.02	Cu	G 1/4
102619	257.02-ES	stainless steel 1.4571	G 1/4
102620	257.03	Cu	G 1/2
139319 NEW	257.03-ES	Stainless steel 1.4571	G 1/2
102621	257.038	Cu	G 3/8



257.02



Self-sealing nipples

Self-sealing nipple for pressure gauge

Art. No.	Type No.	Material	Male thread	Female thread	PN bar
102622	257.11	Brass	G 1/4	G 1/8	250
102623	257.12	Brass	G 3/8	G 1/4	600
102624	257.13	Brass	G 1/2	G 1/4	600
117286 NEW	257.13-ES	Stainless steel 1.4571	G 1/2	G 1/4	600



257.12



257.13-ES

Nipples for pressure gauge

Nipple for pressure gauge

Art. No.	Type No.	Material	Female connector	Male connector	PN bar
102625	257.20	Brass	G 1/8	G 1/4	250
102626	257.21	Brass	G 1/8	G 1/2	250
101249	257.22	Brass	G 1/4	G 1/8	400
102627	257.23	Brass	G 1/4	G 3/8	600
102628	257.24	Brass	G 1/4	G 1/2	600
122588 NEW	257.24-ES	Stainless steel 1.4571	G 1/4	G 1/2	1000



257.23



257.27-ES

Nipples for pressure gauge

Nipple for pressure gauge

Art. No.	Type No.	Material	Female connector	Male connector	PN bar
102629	257.25	Brass	G 1/4	M12x1.5	400
102630	257.26	Brass	G 1/2	G 1/4	400
123289 NEW	257.26-ES	Stainless steel 1.4571	G 1/2	G 1/4	1000
102631	257.27	Brass	G 1/2	G 3/8	600
117285 NEW	257.27-ES	Stainless steel 1.4571	G 1/2	G 3/8	1000
102632	257.30	Brass	G 1/2	M20x1.5	1000
135444 NEW	257.30-ES	Stainless steel 1.4571	G 1/2	M20x1.5	1600

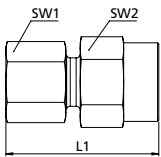

Pressure gauge fittings

galvanised steel acc. DIN 2353



MAV144SLST

Pressure gauge fitting, parallel female thread, very light type

Art. No.	Type No.	Thread	Tube O.D. mm	PN bar	L1 mm	a/f 1 mm	a/f 2 mm
159244	MAV144SLST	G 1/4	4	100	33.0	10	19



V 201

Pressure gauge fitting, parallel female thread, light type

Art. No.	Type No.	Thread	Tube O.D. mm	PN bar	L1 mm	a/f 1 mm	a/f 2 mm
102633	V 200	G 1/4	6	315	37.0	14	19
102634	V 201	G 1/4	8	315	37.0	17	19
102635	V 202	G 1/4	10	315	38.0	19	19
102636	V 203	G 1/4	12	315	38.0	22	19



V 205

Pressure gauge fitting, parallel female thread, heavy type

Art. No.	Type No.	Thread	Tube O.D. mm	PN bar	L1 mm	a/f 1 mm	a/f 2 mm
102637	V 205	G 1/2	6	630	46.0	17	27
102638	V 206	G 1/2	8	630	46.0	19	27
102639	V 207	G 1/2	10	630	47.0	22	27
102640	V 208	G 1/2	12	630	47.0	24	27



V 583

Pressure gauge fitting with cone seal, parallel female thread

Art. No.	Type No.	Thread	Tube O.D. mm	PN bar	L1 mm	a/f 1 mm	a/f 2 mm
112117	V 581	G 1/4	6	315	35.5	14	19
112118	V 582	G 1/4	8	315	36.0	17	19
112119	V 583	G 1/4	10	315	36.5	19	19
112120	V 584	G 1/4	12	315	36.5	22	19

→ Further pressure gauge fittings can be found on page 748, 764 and 768

Pressure gauge stopcocks

for liquids, gases and steam

It is useful to install a stopcock as a shut-off element between the pressure gauge and the pipe. When the lever is set to the »blow out« position, the medium is discharged into the atmosphere. Stopcocks with a test port allow pressure gauges to be simultaneously connected to the pipe.

Applications	For all pressure gauges with a flat gasket acc. to DIN 16258
Hand lever	Plastic
Max. temperature range	50 °C

Pressure gauge stopcock, female - female

Art. No.	Type No.	Thread	PN bar	a/f mm	Test flange	Housing	Standard
102641	9002	G 1/4	6	17		Brass with a bare metal surface	
102642	9003	G 3/8	16	22		Brass with a bare metal surface	
102643	9004/M	G 1/2	25	27		Brass with a bare metal surface	DIN 16261-A
102644	9004/ES	G 1/2	25	27		Stainless steel 1.4571	DIN 16261-A
102645	9005/60	G 1/2	25	27	60x25x10	Brass with a bare metal surface	
102646	9005/40	G 1/2	25	27	40x5	Brass with a bare metal surface	



Pressure gauge stopcock, female - male

Art. No.	Type No.	Thread	PN bar	a/f mm	Test flange	Housing	Standard
102647	9007	G 1/4	6	17		Brass with a bare metal surface	
102648	9008	G 3/8	16	22		Brass with a bare metal surface	
102649	9009/M	G 1/2	25	27		Brass with a bare metal surface	DIN 16261-B
102650	9009/ES	G 1/2	25	27		Stainless steel 1.4571	DIN 16261-B
102651	9010/60	G 1/2	25	27	60x25x10	Brass with a bare metal surface	



Pressure gauge stopcock, female - loose (rotatable) female

Art. No.	Type No.	Thread	PN bar	a/f mm	Test flange	Housing
102652	9012	G 1/2	25	27		Brass with a bare metal surface
102653	9013	G 1/2	25	27	60x25x10	Brass with a bare metal surface



Pressure gauge stopcock, male - loose (rotatable) female

Art. No.	Type No.	Thread	PN bar	a/f mm	Test flange	Housing
102654	9014	G 1/2	25	27		Brass with a bare metal surface
102655	9015	G 1/2	25	27	60x25x10	Brass with a bare metal surface

Pressure gauge stopcock, male - female/female

Art. No.	Type No.	Thread	PN bar	a/f mm	Test flange	Housing	Standard
102656	9020/M	G 1/4	6	17		Brass with a bare metal surface	DIN 16262-B
102657	9021/M	G 1/2	25	27		Brass with a bare metal surface	DIN 16262-A
102658	9021/ES	G 1/2	25	27		Stainless steel 1.4571	DIN 16262-A
102659	9022/M	G 1/2	25	27	60x25x10	Brass with a bare metal surface	
102660	9022/ES	G 1/2	25	27	60x25x10	Stainless steel 1.4571	
102661	9023/M	G 1/2	25	27	40x5	Brass with a bare metal surface	



Pressure gauge valves

Used as shut-off or reducing elements for pressure gauges when measuring liquids, gases or steam.

Wheel	Plastic
Sealant	PTFE



9016/M

Pressure gauge valve, male - female/female, DIN 16270, Type A

Art. No.	Type No.	Operating temperature °C	Housing	Thread	PN bar	a/f mm
102662	9016/M	-10 to 120	Brass	G 1/2	250	27
102663	9016/S	-10 to 120	Black-finished steel	G 1/2	400	27
102664	9016/ES	-20 to 200	Stainless steel 1.4571	G 1/2	400	27



9115/M

Pressure gauge valve, male - loose female and shaft for instrument holder, DIN 16270, Type B

Art. No.	Type No.	Operating temperature °C	Housing	Thread	PN bar	a/f mm
102665	9080/M	-10 to 120	Brass	G 1/2	250	27
102666	9080/ES	-20 to 200	Stainless steel 1.4571	G 1/2	400	27



9180/M

Pressure gauge valve, male - female/female, with test socket M20x1.5, DIN 16271, Type A

Art. No.	Type No.	Operating temperature °C	Housing	Thread	PN bar	a/f mm
102667	9115/M	-10 to 120	Brass	G 1/2	250	27
102668	9115/S	-10 to 120	Black-finished steel	G 1/2	400	27
102669	9115/ES	-20 to 200	Stainless steel 1.4571	G 1/2	400	27



9185/M

Pressure gauge valve, male - loose female and shaft for instrument holder, with test socket M20x1.5, DIN 16271, Type B

Art. No.	Type No.	Operating temperature °C	Housing	Thread	PN bar	a/f mm
102670	9180/M	-10 to 120	Brass	G 1/2	250	27
102671	9180/ES	-20 to 200	Stainless steel 1.4571	G 1/2	400	27

Pressure gauge valve, male - female/female, with test flange 60x25x10

Art. No.	Type No.	Operating temperature °C	Housing	Thread	PN bar	a/f mm
102672	9185/M	-10 to 120	Brass	G 1/2	250	27
102673	9185/ES	-20 to 200	Stainless steel 1.4571	G 1/2	400	27

NEW Pressure gauge double blocking valves

Used as shut-off or reducing elements for pressure gauges when measuring liquids, gases or steam.

Wheel	Plastic
Sealant	PTFE
Valve cone	Stainless steel

Pressure gauge double blocking valve, taps-tension sleeve, DIN 16272, form A

Art. No.	Type No.	Operating temperature °C	Housing	Thread	PN bar	a/f mm	Material
140261	MAVM12A	-10 to 120	Brass	G 1/2	250	27	Brass
169712	MAVES12A	-20 to 200	Stainless steel	G 1/2	400	27	Stainless steel 1.4571
201996	MAVS12A	-10 to 120	Steel	G 1/2	400	27	Steel

Pressure gauge double blocking valve, taps-rotatable sleeve, DIN 16272, form B

Art. No.	Type No.	Operating temperature °C	Housing	Thread	PN bar	a/f mm	Material
143402	MAVM12B	-10 to 120	Brass	G 1/2	250	27	Brass
133464	MAVES12B	-20 to 200	Stainless steel	G 1/2	400	27	Stainless steel 1.4571



MAVM12B

Siphons

acc. to DIN 16282, with clamping sleeve acc. to DIN 16283, a/f 27

Suitable as a cooling section for liquids, gases or steam during pressure measurements. The use of a siphon permits the medium to cool down to a temperature that is compatible with the pressure gauge and protects the gauge against pulsating media. The condensate that forms in the siphon prevents the hot medium from entering the pressure gauge. We recommend filling the siphon with cooling sealing liquid prior to using the pipe.

Siphon, U-shaped, with male connector on pressure tap side

Art. No.	Type No.	Pressure tap	Thread	Material
102674	9072	horizontal	G 1/2	Steel 1.0039, 1.0345
102675	9073	horizontal	G 1/2	CrNi steel 1.4571



9073

Siphon, U-shaped, with welded connection on pressure tap side

Art. No.	Type No.	Pressure tap	Thread	Material
102676	9074	horizontal	G 1/2	Steel 1.0039, 1.0345
102677	9075	horizontal	G 1/2	CrNi steel 1.4571



9083

Siphon, circular, with male connector on pressure tap side

Art. No.	Type No.	Pressure tap	Thread	Material
102678	9082	vertical	G 1/2	Steel 1.0039, 1.0345
102679	9083	vertical	G 1/2	CrNi steel 1.4571

Siphon, circular, with welded connection on pressure tap side

Art. No.	Type No.	Pressure tap	Thread	Material
102680	9084	vertical	G 1/2	Steel 1.0039, 1.0345
102681	9085	vertical	G 1/2	CrNi steel 1.4571

Pressure / Temperature Overview

Material	max. operating pressure [bar]	max. operating temperature before the siphon [°C]
Steel 1.0039, 1.0345	160	120
Steel 1.0039, 1.0345	120	300
Steel 1.0039, 1.0345	104	400
CrNi-Steel 1.4571	160	120
CrNi-Steel 1.4571	140	300
CrNi-Steel 1.4571	131	400



952.24/M

NEW Tension sleeves

Tension sleeves

Art. No.	Type No.	Description	Thread	Female thread	Material
178572	952.24-ES	DIN 16283, hexagonal	G 1/2	G 1/2	Stainless steel 1.4571
120109	952.24/M	DIN 16283, hexagonal	G 1/2	G 1/2	Brass
120110	952.24/S	hexagonal	G 1/2	G 1/2	Burnished steel

Pulsation dampers

for pressure gauges

For damping pulsating pressure loads on pressure gauges.

Temperature range	-10 to 120 °C
PN	400 bar
Thread	G 1/2



9018/M

Pulsation damper for pressure gauge

Art. No.	Type No.	Housing	Screw plug	Adjusting screw	Sealant	a/f mm
102682	9018/M	Brass	Brass	Stainless steel 1.4404	NBR	27
102683	9018/S	Steel	Steel	Stainless steel 1.4404	NBR	27
102684	9018/ES	Stainless steel 1.4571	Stainless steel 1.4571	Stainless steel 1.4404	FKM	27

Pressure gauge pushbutton stopcock

Thread acc. to ISO 228

For measuring local pressure.

The pressure is only measured when the piston is actuated. The measuring system is disconnected again automatically as soon as the piston is released.

In the normal position, no pressure is applied to the pressure gauge.

Material	Nickel-plated brass
Pressure range	Max. 25 bar, max. 4 bar (DVGW approved)



9024

Pressure gauge pushbutton stopcock

Art. No.	Type No.	Thread
102685	9024	G 1/2



Pressure gauge in-line filters

Pressure gauge in-line filters are installed on pressure gauges in dirt-sensitive hydraulic / pneumatic system circuits in order to filter out solids from gaseous and liquid media (floating body retention). Stoppage of small pressure inlet channels and capillary throttles is prevented by their use. Furthermore particles do not jam in dirt-sensitive media chambers and the resulting appearances of a jam are avoided. Preliminary filters act as throttles and dampers with pressure shocks and pressure surges.

Pressure range	Max. 100 bar
Temperature range	-25 to 200 °C
Material	Stainless steel 1.4571
Filter rating	200 µm



9030

Pressure gauge in-line filter

Art. No.	Type No.	Thread 1	Thread 2	a/f mm	Length mm
133873	9030	G 1/4 ET	G 1/4 IT	17	32.0
143860	9031	G 1/2 ET	G 1/2 IT	27	46.0



9031

Accessories for ballast filter

Art. No.	Type No.	Description
139107	257.40	Flat seal made of copper, G 1/4 or M12x1.5, EN 837, hardness 40-60 HB
133875	257.42	Flat sealing ring made of PTFE, G 1/4, EN 837
143858	257.45	Filter disc for pressure gauge in-line filter, G 1/4, CrNi-steel 1.4404
122120	257.41	Flat seal made of copper, G 1/2 or M20x1.5, EN 837, hardness 40-60 HB
122117	257.43	Flat sealing ring made of PTFE, G 1/2, EN 837
143861	257.44	Filter disc for pressure gauge in-line filter, G 1/2, CrNi-steel 1.4404



257.40



257.41



257.45

Gauge holders

acc. to DIN 16281

For mounting shut-off valves with a pressure gauge directly on the wall.



9095



9091

Instrument holder

Art. No.	Type No.	Protrusion	Material
102686	9094	60	Aluminium, painted black
102687	9095	100	Aluminium, painted black
102688	9096	160	Aluminium, painted black
102689	9098	100	CrNi steel 1.4571

Adapter for instrument holder, used to fasten pressure gauges

Art. No.	Type No.	Thread	Material
102690	9091	G 1/2	Brass
102691	9093	G 1/2	Steel

NEW Front glasses



1507656



0429600

Front glass, Plastic, Red pointer

Art. No.	Type No.	Material	Reference pointer	for pressure gauge Ø mm
117438	2196868	Plastic	red, printed on the front glass	40
117211	1614126	Plastic	red, printed on the front glass	50
117195	1507656	Plastic	red, printed on the front glass	63
117391	2094758	Plastic	red, adjustable with a screwdriver	40
117277	SB50V	Plastic	red, adjustable with a screwdriver	50
116716	0429600	Plastic	red, adjustable with a screwdriver	63
117135	1368443	Plastic	red, adjustable with a screwdriver	80

Front glass, Plastic, without red pointer

Art. No.	Type No.	Material	for pressure gauge Ø mm
117340	1936315	Plastic	40
117380	2058189	Plastic	50
117390	2073315	Plastic	63

Front glass made of glass

Art. No.	Type No.	Material	for pressure gauge Ø mm
117136	1376101	glass	40
117400	0021440	glass	50
117401	0021474	glass	63
116682	0216267	glass	100

NEW Adhesive label sets

Ambient temperature -40 to 60 °C

Adhesive label sets for pressure gauges

Art. No.	Type No.	Description
179685	AS63	for pressure gauges Ø-63
179686	AS100	for pressure gauges Ø-100
202181	AS160	for pressure gauges Ø-160



NEW Adjustment key

Adjustment key

Art. No.	Type No.	Material
117319	1926.000.5	VA/Plastic



1926.000.5



NEW Clamp fixing

Clamp fixing for mounting

Art. No.	Type No.	for pressure gauge Ø mm	for pressure gauge types
116724	0618616	63	213.40
117944	25.63.26	63	213.53
117943	25.50.26	50	111.12
122377	1297953	63	111.12



25.63.26

2



618.63.37

NEW front ring

Material	Steel chrome plated
----------	---------------------

front ring

Art. No.	Type No.	for pressure gauge Ø mm
119359	618.63.37	63



ZU 27-GL 1,0

NEW Glycerin

Glycerin

Art. No.	Type No.	Volume Liter
125266	ZU 27-GL 1,0	1

Digital pressure gauges

EASY

Digital pressure gauge in stable plastic housing for monitoring and measuring pressures in dry, oil-free compressed air and non-toxic, non-aggressive gasses.

Areas of application: Pneumatics, machine tools, compressors, automation technology and in general machine construction.

Battery operated

Pressure units: MPa, kgf/cm², bar, psi

Housing	Plastic
Wetted parts	MSV
Protection IP	IP 40 / IP 65 (with hose)
Display	3-digit, 7-segment LCD display
Accuracy	± 0,2% F.S. ± 1 digit
Power supply	Battery CR2032 lithium
Measuring range	0 to 10 bar
Operating temperature	0 to 50 °C
Medium temperature	0 to 50 °C
Ambient temperature	-10 to 60 °C



Digital pressure gauge

Art. No.	Type No.	Description	Thread	Length mm	Width mm	Height mm
133382	DIM-10-F4	without background lighting	R 1/4 ET - M5 IT	30.0	30.0	36.8
133383	DIMH-10-F4	with background lighting	R 1/4 ET - M5 IT	30.0	30.0	36.8



DIM-10-F4

Accessories for digital pressure gauge

Art. No.	Type No.	Description
133384	DIM10-BFWW	Metal mounting bracket, horizontal
133385	DIM10-BFWS	Metal mounting bracket, vertical
133386	DIM10-EBR	Plastic installation frame
133387	DIM10-EBRSA	Installation frame with plastic protective cover



DIM10-BFWW



DIM10-BFWS



DIM10-EBR



DIM10-EBRSA

Pressure transmitters

for universal industrial applications, nonlinearity 0.5%

PLUS

Standard type for universal applications.

Suitable for electronic pressure measurements in the low and high-pressure ranges.

Type	A-10
Housing	CrNi steel 1.4404
Wetted parts	CrNi steel 1.4404
Nonlinearity	0.5% of span
Electrical connection	With right-angle connector acc. to DIN EN 175301-803 A
Protection IP	IP 65 acc. to EN 60529
Operating voltage	8 to 30 V
Output signal	4 - 20 mA, 2-wire
Medium temperature	0 to 80 °C
Ambient temperature	0 to 80 °C



895.19

Pressure transmitter, nonlinearity 0.5%

Art. No.	Type No.	Measuring range bar	Thread
102741	895.15	0 to 1	G 1/4
102742	895.16	0 to 1,6	G 1/4
102743	895.17	0 to 2,5	G 1/4
102744	895.18	0 to 4	G 1/4
102745	895.19	0 to 6	G 1/4
102746	895.20	0 to 10	G 1/4
102747	895.21	0 to 16	G 1/4
102748	895.22	0 to 25	G 1/4
102749	895.23	0 to 40	G 1/4
102750	895.24	0 to 60	G 1/4
102751	895.25	0 to 100	G 1/4
102752	895.26	0 to 160	G 1/4
102753	895.27	0 to 250	G 1/4
102754	895.28	0 to 400	G 1/4
102755	895.29	0 to 600	G 1/4

→ Pressure transmitters with output signal 0 - 10 V, 0 - 5 V and more available on request.

Pressure transmitters

for universal industrial applications, nonlinearity 0.25%

MAX

Pressure transmitters, very high precision, in CrNi steel, for complex measurement tasks in the process industry as well as research and development.

Applications: Low temperature or outdoor applications, extreme shock loads and vibration levels, corrosive media in the chemical industry.

Compatible with all internationally established process connections.

Type	S-20
Housing	CrNi-steel 1.4571
Wetted parts	CrNi-steel 1.4571
Nonlinearity	up to 0.25% of span
Electrical connection	With right-angle connector acc. to DIN EN 175301-803 A
Protection IP	IP 65 acc. to EN 60529
Operating voltage	DC 8 ... 36 V
Output signal	4 - 20 mA, 2-wire
Medium temperature	-30 to 100 °C
Ambient temperature	-30 to 100 °C



Electronic pressure transmitter for universal applications

Art. No.	Type No.	Measuring range bar	Thread
102726	897.0	-1 to 0	G 1/2
102727	897.04	0 to 0,4	G 1/2
102728	897.1	0 to 1	G 1/2
102729	897.4	0 to 4	G 1/2
102730	897.6	0 to 6	G 1/2
102731	897.10	0 to 10	G 1/2
102732	897.16	0 to 16	G 1/2
102733	897.25	0 to 25	G 1/2
102734	897.40	0 to 40	G 1/2
102735	897.60	0 to 60	G 1/2
102736	897.100	0 to 100	G 1/2
102737	897.160	0 to 160	G 1/2
102738	897.250	0 to 250	G 1/2
102739	897.400	0 to 400	G 1/2
102740	897.600	0 to 600	G 1/2



897.10

➔ For high medium temperatures of up to 150 °C, the pressure transmitter is also available with an integrated cooling element.

Pressure transmitters

nonlinearity 0.2%, with zero-point-correction

MAX

Standard type for universal applications. Suitable for electronic pressure measurements in the low and high-pressure ranges.

Type	S-10
Housing	CrNi steel 1.4571
Wetted parts	CrNi steel 1.4571
Nonlinearity	0.2% of span
Electrical connection	With right-angle connector acc. to DIN EN 175301-803 A
Protection IP	IP 65 acc. to EN 60529
Operating voltage	DC 10 ... 30 V
Output signal	4 - 20 mA, 2-wire
Medium temperature	-30 to 100 °C
Ambient temperature	-20 to 80 °C



891.20

Pressure transmitter, nonlinearity 0.2% of span

Art. No.	Type No.	Measuring range bar	Thread
102693	891.11	-1 to 0	G 1/2
102694	891.12	0 to 0,25	G 1/2
102695	891.13	0 to 0,4	G 1/2
102696	891.15	0 to 1	G 1/2
102697	891.18	0 to 4	G 1/2
102698	891.19	0 to 6	G 1/2
102699	891.20	0 to 10	G 1/2
102700	891.21	0 to 16	G 1/2
102701	891.22	0 to 25	G 1/2
102702	891.23	0 to 40	G 1/2
102703	891.24	0 to 60	G 1/2
102704	891.25	0 to 100	G 1/2
102705	891.26	0 to 160	G 1/2
102706	891.27	0 to 250	G 1/2
102707	891.28	0 to 400	G 1/2
102708	891.29	0 to 600	G 1/2

→ Pressure transmitters with a flush diaphragm for measuring high-viscosity and crystalline media available on request.

Pressure transmitters

for viscous and solids-containing media, nonlinearity 0.2%, with zero-point-correction



Pressure transmitter in CrNi steel with flush diaphragm for measuring viscous, pasty, adhesive, crystallising, particle-laden or contaminated media, which would clog the pressure channel of conventional process connections.

Applications: Electronic pressure measurement in the food and beverages sector, hydraulic power units or industrial applications in general.

Type	S-11
Housing	CrNi steel 1.4571
Wetted parts	CrNi steel 1.4571
Nonlinearity	0.2% of span
Electrical connection	With right-angle connector acc. to DIN EN 175301-803 A
Protection IP	IP 65 acc. to EN 60529
Operating voltage	DC 10 ... 30 V
Output signal	4 - 20 mA, 2-wire
Medium temperature	-30 to 100 °C
Ambient temperature	-20 to 80 °C



Electronic pressure transmitter for viscous and solids-containing media

Art. No.	Type No.	Measuring range bar	Thread
102709	896.02	0 to 0,25	G 1
102710	896.04	0 to 0,4	G 1
102711	896.1	0 to 1	G 1
102712	896.4	0 to 4	G 1/2
102713	896.6	0 to 6	G 1/2
102714	896.10	0 to 10	G 1/2
102715	896.16	0 to 16	G 1/2
102716	896.25	0 to 25	G 1/2
102717	896.40	0 to 40	G 1/2
102718	896.60	0 to 60	G 1/2
102719	896.100	0 to 100	G 1/2
102720	896.160	0 to 160	G 1/2
102721	896.250	0 to 250	G 1/2
102722	896.400	0 to 400	G 1/2
102723	896.600	0 to 600	G 1/2



896.10

➔ Pressure transmitters with a flush diaphragm for measuring high-viscosity and crystalline media available on request.

Welding socket flush, stainless steel 1.4571, for pressure transmitter S-11

Art. No.	Type No.	Description
102725	896.STU-2	Welding socket - flush G 1
102724	896.STU-1	Welding socket - flush G 1/2



896.STU-1

Microprocessor-controlled digital display unit

panel-mounting type

MAX

Compact, universal, digital display unit, adapts flexibly to the required measurement task in the field. No tools required. 4-digit LED display, digits 10 mm high, red.

Input	freely selectable 4 - 20 mA, 0 - 20 mA, 0 - 1 V, 0- 10 V
Analogue output	Two freely programmable transistor switching outputs
Digital output	RS 485
Power supply	9 ... 28 V DC, max. current input 60 mA with 12 V DC
Protection IP	IP 65 on front
Accuracy	$\pm 0.5\% \pm 1$ digit of span



894.10

Compact digital display

Art. No.	Type No.	Width mm	Height mm
102757	894.10	48.0	24.0

Digital plug-in display

for pressure transmitters

The digital plug-in display is freely programmable and easily mounted, and can therefore be retrofitted in a very short time without any problems, even if the transmitter is already in use. No external power supply is required. Suitable for all 4 to 20 mA transmitters with a right-angle connector. Freely programmable by means of keys inside the display.

Measuring range	-1999 to +9999 digits (min. and max. values freely scalable)
Display	4-digit, 7-segment LCD display, digits 10 mm high
Operating temperature	0 to 50 °C
Input signal	4 to 20 mA, 2-wire
Electrical connection	Adapter for plug acc. to DIN EN 175301-803 A
Power supply	From 4 to 20 mA loop of transmitter
Protection IP	IP 65
Accuracy	$\pm 0.2\% \pm 1$ digit of span



894.20

Digital plug-in display

Art. No.	Type No.	Length mm	Width mm	Height mm
102756	894.20	48.5	48.5	35.5

Bimetallic thermometers

for heating plants



Applications: Heating, plumbing, universal.

Type	46
Housing	Plastic
Front glass	Plexiglass
Display correction	On end of stem (Ø 9 mm)
Thermowell	Clamped (removable), copper alloy
Operating pressure	Max. 6 bar (on thermowell)

Bimetallic thermometer, connection on rear, class 2.0

Art. No.	Type No.	Indicating range °C	Stem length mm	Diameter mm	Thread
102759	4601	0 to 60	40	63	G 1/2
102760	4602	0 to 120	40	63	G 1/2
102761	4603	0 to 60	60	63	G 1/2
102762	4604	0 to 120	60	63	G 1/2
102763	4605	0 to 60	100	63	G 1/2
102764	4606	0 to 120	100	63	G 1/2
102765	4611	0 to 60	40	80	G 1/2
102766	4612	0 to 120	40	80	G 1/2
102767	4613	0 to 60	60	80	G 1/2
102768	4614	0 to 120	60	80	G 1/2
102769	4615	0 to 60	100	80	G 1/2
102770	4616	0 to 120	100	80	G 1/2



4612

Bimetallic thermometers

industrial type



Applications: Versatile design for use in industrial applications.

Type	52
Housing	CrNi steel
Bezel	CrNi steel
Front glass	Flat instrument glass
Display correction	Trimming pointer
Stem	Ø 8 mm, CrNi steel 1.4571
Operating pressure	Max. 25 bar (on stem)

Bimetallic thermometer, connection on rear, class 1.0

Art. No.	Type No.	Indicating range °C	Stem length mm	Diameter mm	Thread
102771	5201	-30 to 50	63	100	G 1/2
102772	5202	0 to 120	63	100	G 1/2
102773	5203	0 to 160	63	100	G 1/2
102774	5204	0 to 200	63	100	G 1/2
102775	5206	-30 to 50	100	100	G 1/2
102776	5207	0 to 120	100	100	G 1/2
102777	5208	0 to 160	100	100	G 1/2
102778	5209	0 to 200	100	100	G 1/2
102779	5210	0 to 250	100	100	G 1/2
102780	5211	-30 to 50	160	100	G 1/2
102781	5212	0 to 120	160	100	G 1/2
102782	5214	0 to 200	160	100	G 1/2



5203

Bimetallic thermometers

high-quality type



Applications: Extremely versatile design for use in machine, vessel, pipeline and plant construction as well as for heating systems.

A thermowell (removable with locking screw) is required.

Type	52
Housing	CrNi steel
Bezel	CrNi steel
Front glass	Flat instrument glass
Display correction	Trimming pointer
Stem	Ø 8 mm, CrNi steel
Connection	Flush, with collar for thermowell, Ø 18 mm
Operating pressure	Max. 25 bar (on thermowell)



5242

Bimetallic thermometer, connection on rear, class 1.0

Art. No.	Type No.	Indicating range °C	Suitable for thermowell types	Diameter mm
102783	5221	-30 to 50	SR01 / SR11 / SR21	63
102784	5222	0 to 120	SR01 / SR11 / SR21	63
102785	5223	0 to 160	SR01 / SR11 / SR21	63
102786	5224	0 to 200	SR01 / SR11 / SR21	63
102787	5225	0 to 250	SR01 / SR11 / SR21	63
102788	5226	-30 to 50	SR02 / SR12 / SR22	63
102789	5227	0 to 120	SR02 / SR12 / SR22	63
102790	5228	0 to 160	SR02 / SR12 / SR22	63
102791	5229	0 to 200	SR02 / SR12 / SR22	63
102792	5230	0 to 250	SR02 / SR12 / SR22	63
102793	5231	-30 to 50	SR03 / SR13 / SR23	63
102794	5232	0 to 120	SR03 / SR13 / SR23	63
102795	5233	0 to 160	SR03 / SR13 / SR23	63
102796	5241	-30 to 50	SR01 / SR11 / SR21	100
102797	5242	0 to 120	SR01 / SR11 / SR21	100
102798	5243	0 to 160	SR01 / SR11 / SR21	100
102799	5245	0 to 250	SR01 / SR11 / SR21	100
102800	5246	-30 to 50	SR02 / SR12 / SR22	100
102801	5247	0 to 120	SR02 / SR12 / SR22	100
102802	5248	0 to 160	SR02 / SR12 / SR22	100
102803	5249	0 to 200	SR02 / SR12 / SR22	100
102804	5250	0 to 250	SR02 / SR12 / SR22	100
102805	5251	-30 to 50	SR03 / SR13 / SR23	100
102806	5252	0 to 120	SR03 / SR13 / SR23	100
102807	5253	0 to 160	SR03 / SR13 / SR23	100
102808	5254	0 to 200	SR03 / SR13 / SR23	100
102809	5255	0 to 250	SR03 / SR13 / SR23	100

→ You can find thermowells on page 259

Screw-in thermowells

with locking screw, copper alloy or CrNi steel 1.4571

For bimetallic thermometers in the »High quality« series.

Connecting thread	G 1/2
Sealing collar Ø	26 mm
Thermowell Ø	10 mm

Screw-in thermowell					
Art. No.	Type No.	Max. operating pressure bar	a/f mm	L1 mm	Material
102810	SR 01	6	27	63.0	Copper alloy
102811	SR 02	6	27	100.0	Copper alloy
102812	SR 03	6	27	160.0	Copper alloy
102813	SR 11	25	27	63.0	CrNi steel 1.4571
102814	SR 12	25	27	100.0	CrNi steel 1.4571
102815	SR 13	25	27	160.0	CrNi steel 1.4571



Weld-in thermowells

with locking screw, CrNi steel 1.4571

For bimetallic thermometers in the »High quality« series.

Material	CrNi steel 1.4571
Welded male connector Ø	24 mm
Welded male connector length	33 mm
Thermowell Ø	10 mm
Max. operating pressure	25 bar

Weld-in thermowell		
Art. No.	Type No.	L2 mm
102816	SR 21	43.0
102817	SR 22	80.0
102818	SR 23	140.0





HOLD

TIGHT.

EVEN UNDER

PRESSURE.

In-line ball valves nickel-plated brass



Standard type with hand lever
Page 274-275



Standard type with butterfly handle
Page 275



Standard type
Page 276



With steel lever
Page 277-278



Long-threaded type
Page 279



Heavy-duty type with hand lever
Page 280



Heavy-duty type with butterfly handle
Page 281



for gas installations with hand lever
Page 282



for gas installations with butterfly handle
Page 282



Angle-type ball valves
Page 283



for potable water
Page 284

In-line ball valves nickel-plated brass



Stainless steel ball valves, 2-piece
Page 285



2-piece, length acc. to DIN 3202-M3
Page 286



3-piece, length acc. to DIN 3202-M3
Page 286



Stainless steel ball valves, with weld-on ends
Page 287



Stainless steel ball valves, 1-piece
Page 287



Stainless steel ball valves, mini series
Page 288

Safety ball valves



Non-lockable, with relief port
Page 289



Lockable, without relief port
Page 289



Lockable with relief port
Page 290



with spring return
Page 291



Lockable with relief port, stainless steel
Page 292

Mini ball valves



Mini ball valves
Page 293



Mini ball valves with wing lever
Page 293



with smooth surface
Page 294



Angle mini ball valves
Page 294



3-way mini ball valves
Page 295



Mini safety ball valves
Page 296



sandblasted type
Page 296



stainless steel
Page 297

KFE ball valves



Brass / Nickel-plated brass
Page 298

Bibcocks



nickel-plated brass
Page 299

Bibcocks



stainless steel
Page 299

3-way ball valves



3-way ball valves,
standard type, T-bore
Page 300



3-way ball valves,
standard type, L-bore
Page 300



3-way ball valves,
sealing on all sides,
L or T-bore
Page 301



Lower media connection
Page 302



Stainless steel ball valves,
3-way
Page 303

High-pressure ball valves



steel
Page 304

**Ball valves
with pneumatic actuator**



Brass ball valves
Page 305



2-way brass ball valves
Page 306

**Ball valves
with pneumatic actuator**



3-way brass ball valves
Page 307



Stainless steel ball valves
Page 308



2-way
stainless steel ball valves
Page 309



3-way
stainless steel ball valves
Page 310



End position feedback
aluminium
Page 311



End position feedback
polyamide
Page 312

**Ball valves
with electric actuator**



Brass ball valves
Page 313



Stainless steel ball valves
Page 314

Butterfly valves



With pneumatic actuator
Page 315



With hand lever
Page 316

Coaxial valves



Coaxial valves
Page 317-318

Angle-seat valves with piston actuator



Bronze version
Page 319



Stainless steel version
Page 320

Solenoid valves



2/2-way solenoid valves
Page 321-323



professional standard series
Page 324-327



2/2-way solenoid valves,
standard type
Page 328-330



Media-separated solenoid
valves
Page 331-334



3/2-way solenoid valves,
spring return
Page 334



3/2-way solenoid valves
Page 335



3/2-way solenoid valves,
banjo connection
Page 335

Solenoid valves

 Diaphragm pulse valves
Page 336

 2/2-way solenoid valves, stainless steel
Page 337

Pressure switch

 Standard type
Page 338

 Changeover type
Page 338

 Changeover type, can be rotated 360°
Page 339

 With bayonet coupling
Page 339

 Vacuum type
Page 340

 Mini type
Page 340

 Low pressures
Page 341

 Changeover type, suitable for flange mounting
Page 341-342

 »PDS« type
Page 342

Pressure switch

 For compressors
Page 343-345

 Electronic, with digital display, 2-colour
Page 346

 Electronic, with digital display
Page 347

Other shut-off devices

 Manual slide valves
Page 348

 Needle valves brass
Page 348

 Angle-type globe valves
Page 349

 Globe valves
Page 349

 Drain and vent valves
Page 349

 Needle valves nickel-plated brass
Page 350

 Bidirectional flow control valves
Page 351

 Unidirectional flow control valves
Page 351

Other shut-off devices

 Female thread brass globe valves
Page 352

 Female thread gate valves
Page 352

 Needle valves stainless steel
Page 353

 Bidirectional flow control valves stainless steel
Page 353

 Unidirectional flow control valves stainless steel
Page 353

 Female thread globe valves stainless steel
Page 354

 Female thread gate valves stainless steel
Page 354

Non-return valves

 Straight-way type, brass and stainless steel
Page 355

 Straight-way type, small design
Page 355

 Straight-way type
Page 356

 Angle-seat type, brass
Page 356

Non-return valves



Angle-seat type,
stainless steel
Page 357



Straight-way type
stainless steel
Page 357



straight-way type,
lightweight series
Page 358



Strainers
with plastic thread
Page 358



Strainers
for check valves
Page 359

Strainers



Brass
Page 366



Bronze
Page 367



Stainless steel
Page 368

Safety valves



Mini-blow-off valves, brass
Page 360



Safety valves DN 8
Page 361



Safety valves DN 10
Page 362



High-pressure type
with high blow-off rate
Page 363



Angle-type safety valves
Page 363-364



Mini-blow-off valves,
stainless steel
Page 365

Notes

Grid area for notes.



Model	Type no.	max. operating pressure [bar]	Temperature range [°C]	Media						Material			
				Compressed air	Water	Non-toxic and non-aggressive gases and liquids	Oil	Potable water (DVGW approval)	Gas (DVGW approval)	Brass	Brass chrome plated	Brass nickel-plated	
	329.XX-R	16 to 50	-20 to 150	•	•	•							•
	330.XX(-X) / 331.XX(-X)	40 to 63	-15 to 90	•	•	•							•
	336.0X / 337.0X	40	-15 to 90	•	•	•							•
	3350.XX / 3351.XX / 3340.XX	40 to 100	-20 to 130	•	•	•	•						•
	350.11XX	40 Gas: 5	-15 to 90 Gas: -15 to 60	•	•	•				•			•
	350.XXX	40 Gas: 5	-15 to 100 Gas: -15 to 60	•	•	•	•			•			•
	350.77XX	40	-15 to 110		•			•			•		•
	3395.XX	40 to 63	-20 to 180	•	•	•	•						
	397.0X	63	-20 to 180	•	•	•	•						
	3390.XX	40 to 63	-20 to 180	•	•	•	•						
	391.0X	63	-20 to 150	•	•	•	•						
	398.0X	63	-20 to 150	•	•	•	•						
	374.0X-ES	63	-20 to 150	•	•	•	•						
	375.0X-ES	63	-20 to 150	•	•	•	•						
	350.50X	12	0 to 60	•									•
	320.0X	40 to 65	-40 to 170	•	•	•	•						•
	321.0X	14	-10 to 100	•									•









Material		Seal				lockable	Features	From page
Steel	Stainless steel	Ball seal	Spindle seal	lockable with ventilation hole				
		PTFE	NBR / FKM			Basic design with lever or butterfly handle, threads: Interior/interior or interior / exterior	274	
		PTFE	HNBR / EPDM / PTFE			Basic design with additional gasket Lever in various colours. Threads: Interior/ interior and interior/exterior	276	
		PTFE	HNBR / EPDM / PTFE			Long thread: Interior / interior, interior / exterior	279	
		PTFE	PTFE			Heavy duty design. Full passage. With lever or butterfly handle. Threads: Interior/interior, interior/exterior, exterior/exterior	280	
		PTFE	HNBR / EPDM / PTFE			DVGW approval for gas, lever or butterfly handle, threads: Interior/interior and interior/exterior	282	
		PTFE	NBR			Rectangular ball valve, threads: Interior/interior, interior/exterior, exterior/exterior	283	
		PTFE	PTFE/ EPDM/ HNBR			DVGW approved for potable water	284	
	•	PTFE	PTFE		•	2-part, threads to 3: Interior/interior, interior / exterior	285	
	•	PTFE	PTFE		•	2-part, with full passage, lockable	286	
	•	PTFE	PTFE		•	3-part ball valve, maintenance without removing the threaded ends	286	
	•	PTFE	PTFE		•	3-part, full passage, with welded ends, maintenance without removing the threaded ends	287	
	•	RPTFE	PTFE			1-part, compact design, reduced passage	287	
	•	RPTFE	PTFE			1-part in compact design	288	
	•	RPTFE	RPTFE			1-part in compact design up to 2"	288	
		PTFE	PTFE	•		Safety ball valve, in closed state is vented in application area	289	
		PTFE	PTFE		•	lockable handle	289	
		PTFE	FKM	•	•	Venting in closed state	290	



Model	Type no.	max. operating pressure [bar]	Temperature range [°C]	Media						Material			
				Compressed air	Water	Non-toxic and non-aggressive gases and liquids	Oil	Potable water (DVGW approval)	Gas (DVGW approval)	Brass	Brass chrome plated	Brass nickel-plated	
	KHF-XX	40 to 65	-40 to 170	•	•	•	•						•
	3396.0X	17	-20 to 160	•									
	371.XXX 373.XX / (-X) 374.XX 375.XX	max. 10	-10 to 70	•	•		•						•
	380.XX 381.XX 382.XX	20	-20 to 80	•	•	•	•					•	
	377.0X	20	-20 to 80	•	•		•						•
	377.XX-ES 376.XX-ES / 379.XX-ES	63	-20 to 120	•	•								
	KFE-12(X)	10	0 to 110	•	•	•					•		•
	KAH.XX	12 to 15	-20 to 80	•	•	•							•
	KAH.XX-ES	16	-10 to 150	•	•	•							
	1083 X / 1084 X(X)	16 to 40	-15 to 100	•	•	•	•						•
	1081 X	10	-10 to 120	•	•	•	•						•
	1085 X 1086 X	10 to 25	-15 to 120	•	•	•							•
	392.XX	420 to 500	-10 bis 100			•	•						

Material		Seal				Features	From page
Steel	Stainless steel	Ball seal	Spindle seal	lockable with ventilation hole	lockable		
		PTFE	FKM			With spring reset	291
	•	PTFE	PTFE	•	•	Venting in closed state, lockable	292
		PTFE	NBR or FKM			Compact design threads: interior/interior, interior/exterior, exterior/interior, exterior/exterior	293
		PTFE	NBR			Compact for control panel installation with T or L hole	294
		PTFE	NBR	•		Compact design with ventilation	296
	•	PTFE	FKM			Compact design	297
		PTFE	EPDM			Drain cock for heating systems	298
		NBR				Rectangular drain valve with hose connector	299
	•	PTFE	NBR		•	Drain valve with hose connector	299
		PTFE	FKM			Sealing on all sides, with T or L hole	300
		PTFE	PTFE			with L-hole For general industrial applications	300
		PTFE	PTFE/ FKM			with T or L hole, media connection below, full passage, integrated ISO flange plate	302
•		POM				High pressure design made of machining steel in lighter and heavier design	304



Model	Type no.	max. operating pressure [bar]	Temperature range [°C]	Media						Material			
				Compressed air	Water	Non-toxic and non-aggressive gases and liquids	Oil	Potable water (DVGW approval)	Gas (DVGW approval)	Brass	Brass chrome plated	Brass nickel-plated	
	351.2XX-1 351.3XX-1	16	-20 to 150	•	•	•							•
	350.21X 350.31X 350.41X	16 to 40	-20 to 70	•	•	•							•
	350.61X 350.71X 350.72X KHRP	25 to 40	-20 to 70	•	•	•							•
	351.51X - X 351.52X - X	40 to 100	-20 to 150	•	•	•	•						
	350.5XX	63	20 to 70	•	•	•							
	350.6XX 350.9XX KHRP	63	-20 to 70	•	•	•							
	350.18XXR 350.28XXR	25 to 40	-20 to 70	•	•	•							•
	350.38XXR 350.48XXR	63	-10 to 200	•	•	•							

Material		Seal				Features	From page
Steel	Stainless steel	Ball seal	Spindle seal	lockable with ventilation hole	lockable		
		PTFE	FKM			Double-acting or single-acting (spring force opening or closing) end) actuator Control with filtered air at max. 5.6 bar	305
		PTFE	PTFE			Double-acting or single-acting (spring force opening or closing) end) actuator Control with filtered air at max. 5.5 bar	306
		PTFE glass fibre reinforced	PTFE			Double-acting or single-acting (spring force opening or closing) end) actuator Control with filtered air at max. 5.5 bar	307
	•	PTFE	FKM			Double-acting or single-acting (spring force opening or closing) end) actuator Control with filtered air at max. 5.6 bar	308
	•	PTFE glass fibre reinforced	PTFE glass fibre reinforced			Double-acting or single-acting (spring force opening or closing) end) actuator Control with filtered air at max. 5.5 bar	309
	•	PTFE	FKM			Double-acting or single-acting (spring force opening or closing) end) actuator Control with filtered air at max. 5.5 bar	310
		PTFE glass fibre reinforced	PTFE glass fibre reinforced			Control via 230 VAC or 24 VDC	313
	•	PTFE glass fibre reinforced	PTFE glass fibre reinforced			Control via 230 VAC or 24 VDC	314



Model	Type no.	Base body material	Operating pressure [bar]	Temperature range [°C]
	9227.XX	Messing	12 to 25	-20 to 100
	228.XX	Brass nickel-plated	10	-10 to 70
	227.01 to 227.03	Messing	16	-25 to 140
	227.04 227.05	Messing	16	-10 to 180
	227.10 to 227.12	Messing	16	-20 to 180
	227.13 227.14	Messing	16	-10 to 180
	220.0X	Messing	10	-30 to 90
	220.0X-ES	Edelstahl	40	-29 to 180
	228.0X-ES	Edelstahl	10	-10 to 150
	228.1X-ES 228.2X-ES 228.3X-ES 228.11X-ES	Edelstahl	16	-20 to 150
	SKR-XX(-K) SKR-XXX(-K)	Edelstahl		max. 150

Flow control	Passage type	Angled seat shape	Opening pressure [bar]	From page
Full passage	•		0.01-0.03	355
	•		0.15 - 0.35	355
Arbitrary flow direction with horizontal installation	•		0.4 - 0.5	356
Arbitrary flow direction with horizontal installation	•		0.1	356
Arbitrary flow direction with horizontal installation	•		0.4 - 0.5	356
Arbitrary flow direction with horizontal installation	•		0.1	356
		•	0.5	356
		•	0.2	357
	•		0.2	357
Full passage	•		0.03	358
				358



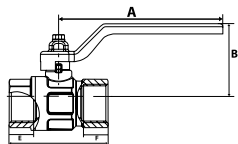

Ball valves

Standard type, with full bore

PLUS

Applications: Compressed air, water, non-toxic and non-corrosive gases, heating systems and air conditioning systems.

Material	Nickel-plated brass
Ball	Chrome-plated brass
Ball seal	PTFE
Stem seal	NBR / FKM (Seal package consists of 2 O-rings)
Operating temperature	-20 °C to 150 °C (no steam)
Standard thread	G-thread acc. to DIN EN ISO 228-1, tolerance class B



329.04-R

Ball valve with hand lever red, standard type, female/female thread

Art. No.	Type No.	Thread	Thread material	DN	PN bar	L mm	A mm	B mm	E mm	F mm
103093	329.02-R	G 1/4	Nickel-plated brass	8	50	44.4	80.0	37.0	10.0	10.0
103094	329.03-R	G 3/8	Nickel-plated brass	10	50	44.4	80.0	37.0	10.0	10.0
103095	329.04-R	G 1/2	Nickel-plated brass	15	50	50.5	80.0	41.0	12.5	12.0
103096	329.05-R	G 3/4	Nickel-plated brass	20	40	57.5	113.0	55.0	13.5	12.5
103097	329.06-R	G 1	Nickel-plated brass	25	40	70.0	113.0	59.0	15.0	15.0
103098	329.07-R	G 1 1/4	Nickel-plated brass	32	30	80.5	138.0	75.0	16.5	17.0
103099	329.08-R	G 1 1/2	Nickel-plated brass	40	30	94.5	138.0	81.0	17.5	18.5
103100	329.09-R	G 2	Nickel-plated brass	50	25	112.5	157.8	96.0	20.5	22.0
103101	329.10-R	G 2 1/2	Nickel-plated brass	65	18	134.5	197.0	115.0	24.0	24.0
103102	329.11-R	G 3	Nickel-plated brass	80	16	157.0	250.0	133.0	26.0	26.0



329.04-S

Ball valve with hand lever black, standard type, female/female thread

Art. No.	Type No.	Thread	Thread material	DN	PN bar	L mm	A mm	B mm	E mm	F mm
129122 NEW	329.02-S	G 1/4	Nickel-plated brass	8	50	44.4	80.0	37.0	10.0	10.0
129123 NEW	329.03-S	G 3/8	Nickel-plated brass	10	50	44.4	80.0	37.0	10.0	10.0
129124 NEW	329.04-S	G 1/2	Nickel-plated brass	15	50	50.5	80.0	41.0	12.5	12.0
129125 NEW	329.05-S	G 3/4	Nickel-plated brass	20	40	57.5	113.0	55.0	13.5	12.5
129126 NEW	329.06-S	G 1	Nickel-plated brass	25	40	70.0	113.0	59.0	15.0	15.0
129127 NEW	329.07-S	G 1/4	Nickel-plated brass	32	30	80.5	138.0	75.0	16.5	17.0
129128 NEW	329.08-S	G 1 1/2	Nickel-plated brass	40	30	94.5	138.0	81.0	17.5	18.5
129129 NEW	329.09-S	G 2	Nickel-plated brass	50	25	112.5	157.8	96.0	20.5	22.0
129130 NEW	329.10-S	G 2 1/2	Nickel-plated brass	65	18	134.5	197.0	115.0	24.0	24.0
129131 NEW	329.11-S	G 3	Nickel-plated brass	80	16	157.0	250.0	133.0	26.0	26.0



329.24-R

Ball valve with hand lever red, standard type, female/male thread

Art. No.	Type No.	Thread	Thread material	DN	PN bar	L mm	A mm	B mm	E mm	F mm
103103	329.22-R	G 1/4	Nickel-plated brass	8	50	54.0	80.0	37.0	10.5	10.0
103104	329.23-R	G 3/8	Nickel-plated brass	10	50	54.0	80.0	37.0	10.5	10.0
103105	329.24-R	G 1/2	Nickel-plated brass	15	50	58.5	80.0	41.0	11.5	12.0
103106	329.25-R	G 3/4	Nickel-plated brass	20	40	66.5	113.0	55.0	13.5	12.5
103107	329.26-R	G 1	Nickel-plated brass	25	40	78.5	113.0	59.0	14.5	15.0
103108	329.27-R	G 1 1/4	Nickel-plated brass	32	30	91.5	138.0	75.0	17.0	17.0
103109	329.28-R	G 1 1/2	Nickel-plated brass	40	30	105.5	138.0	81.0	19.0	18.5
103110	329.29-R	G 2	Nickel-plated brass	50	25	122.0	157.8	96.0	21.0	22.0



329.22-S

Ball valve with hand lever black, standard type, female/male thread

Art. No.	Type No.	Thread	Thread material	DN	PN bar	L mm	A mm	B mm	E mm	F mm
129132 NEW	329.22-S	G 1/4	Nickel-plated brass	8	50	54.0	80.0	37.0	10.5	10.0
129133 NEW	329.23-S	G 3/8	Nickel-plated brass	10	50	54.0	80.0	37.0	10.5	10.0
129134 NEW	329.24-S	G 1/2	Nickel-plated brass	15	50	58.5	80.0	41.0	11.5	12.0
129135 NEW	329.25-S	G 3/4	Nickel-plated brass	20	40	66.5	113.0	55.0	13.5	12.5
129136 NEW	329.26-S	G 1	Nickel-plated brass	25	40	78.5	113.0	59.0	14.5	15.0
129137 NEW	329.27-S	G 1/4	Nickel-plated brass	32	30	91.5	138.0	75.0	17.0	17.0

Ball valves

Standard type, with full bore

PLUS

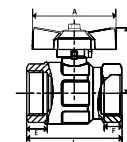

Ball valve with hand lever black, standard type, female/male thread

Art. No.	Type No.	Thread	Thread material	DN	PN bar	L mm	A mm	B mm	E mm	F mm
129138 NEW	329.28-S	G 1 1/2	Nickel-plated brass	40	30	105.5	138.0	81.0	19.0	18.5
129139 NEW	329.29-S	G 2	Nickel-plated brass	50	25	122.0	157.8	96.0	21.0	22.0



329.44-R

Ball valve with butterfly handle red, standard type, female/female thread

Art. No.	Type No.	Thread	Thread material	DN	PN bar	L mm	A mm	B mm	E mm	F mm
103111	329.42-R	G 1/4	Bright brass	8	50	44.4	47.0	37.0	10.0	10.0
103112	329.43-R	G 3/8	Bright brass	10	50	44.4	47.0	37.0	10.0	10.0
103113	329.44-R	G 1/2	Bright brass	15	50	50.5	47.0	41.0	12.5	12.0
103114	329.45-R	G 3/4	Bright brass	20	40	57.5	62.0	55.0	13.5	12.5
103115	329.46-R	G 1	Bright brass	25	40	70.0	62.0	59.0	15.0	15.0
103116	329.47-R	G 1 1/4	Bright brass	32	30	80.5	70.0	75.0	16.5	17.0



329.44-S

Ball valve with butterfly handle black, standard type, female/female thread

Art. No.	Type No.	Thread	Thread material	DN	PN bar	L mm	A mm	B mm	E mm	F mm
129140 NEW	329.42-S	G 1/4	Bright brass	8	50	44.4	47.0	37.0	10.0	10.0
129141 NEW	329.43-S	G 3/8	Bright brass	10	50	44.4	47.0	37.0	10.0	10.0
129142 NEW	329.44-S	G 1/2	Bright brass	15	50	50.5	47.0	41.0	12.5	12.0
129143 NEW	329.45-S	G 3/4	Bright brass	20	40	57.5	62.0	55.0	13.5	12.5
129144 NEW	329.46-S	G 1	Bright brass	25	40	70.0	62.0	59.0	15.0	15.0
129145 NEW	329.47-S	G 1/4	Bright brass	32	30	80.5	70.0	75.0	16.5	17.0



329.54-R



Ball valve with butterfly handle red, standard type, female/male thread

Art. No.	Type No.	Thread	Thread material	DN	PN bar	L mm	A mm	B mm	E mm	F mm
103117	329.52-R	G 1/4	Bright brass	8	50	54.0	47.0	37.0	10.5	10.0
103118	329.53-R	G 3/8	Bright brass	10	50	54.0	47.0	37.0	10.5	10.0
103119	329.54-R	G 1/2	Bright brass	15	50	58.5	47.0	41.0	11.5	12.0
103120	329.55-R	G 3/4	Bright brass	20	40	66.5	62.0	47.0	13.5	12.5
103121	329.56-R	G 1	Bright brass	25	40	78.5	62.0	51.0	14.5	15.0
103122	329.57-R	G 1 1/4	Bright brass	32	30	91.5	70.0	64.0	17.0	17.0



329.54-S

Ball valve with butterfly handle black, standard type, female/male thread

Art. No.	Type No.	Thread	Thread material	DN	PN bar	L mm	A mm	B mm	E mm	F mm
129146 NEW	329.52-S	G 1/4	Bright brass	8	50	54.0	47.0	37.0	10.5	10.0
129147 NEW	329.53-S	G 3/8	Bright brass	10	50	54.0	47.0	37.0	10.5	10.0
129148 NEW	329.54-S	G 1/2	Bright brass	15	50	58.5	47.0	41.0	11.5	12.0
129149 NEW	329.55-S	G 3/4	Bright brass	20	40	66.5	62.0	47.0	13.5	12.5
129150 NEW	329.56-S	G 1	Bright brass	25	40	78.5	62.0	51.0	14.5	15.0
129151 NEW	329.57-S	G 1/4	Bright brass	32	30	91.5	70.0	64.0	17.0	17.0

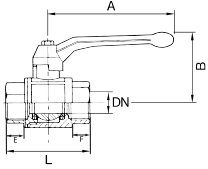

Ball valves

Standard type, with full bore

PLUS

Applications: Compressed air, water, non-toxic and non-corrosive gases, heating systems, agriculture.

Material	Nickel-plated brass
Ball	Chrome-plated brass
Ball seal	PTFE
Stem seal	2 O-rings HNBR/EPDM peroxide crosslinked, sealing ring PTFE
Hand lever	Aluminium, painted black
Operating temperature	-15 to 90 °C
Thread material	Brass with a bare metal surface
Standard thread	G thread acc. to DIN EN ISO 228-1



330.06

Ball valve, standard type, female/female thread

Art. No.	Type No.	Thread	DN	PN bar	L mm	A mm	B mm	E mm	F mm
103123	330.02	G 1/4	8	63	46.0	85.0	42.0	12.0	12.0
103124	330.03	G 3/8	10	63	50.0	85.0	42.0	12.0	12.0
103125	330.04	G 1/2	15	40	50.0	85.0	45.8	9.5	9.5
103126	330.05	G 3/4	20	40	58.0	105.0	53.4	10.5	10.5
103127	330.06	G 1	25	40	69.0	105.0	57.3	12.0	12.0
103128	330.07	G 1 1/4	32	40	80.0	130.0	70.1	13.5	13.5
103129	330.08	G 1 1/2	40	40	91.5	130.0	76.1	14.5	14.5
103130	330.09	G 2	50	40	109.0	165.0	92.4	16.5	16.5
103131	330.10	G 2 1/2	65	40	133.0	260.0	116.0	18.5	18.5
103132	330.11	G 3	80	40	156.0	260.0	127.0	18.5	18.5



331.06

Ball valve, standard type, female/male thread

Art. No.	Type No.	Thread	DN	PN bar	L mm	A mm	B mm	E mm	F mm
103133	331.02	G 1/4	8	63	51.0	85.0	42.0	9.4	12.0
103134	331.03	G 3/8	10	63	53.0	85.0	42.0	8.6	12.0
103135	331.04	G 1/2	15	40	59.8	85.0	45.8	9.5	9.5
103136	331.05	G 3/4	20	40	69.5	105.0	53.4	10.5	10.5
103137	331.06	G 1	25	40	78.8	105.0	57.3	12.0	12.0
103138	331.07	G 1 1/4	32	40	91.5	130.0	70.1	13.0	13.5
103139	331.08	G 1 1/2	40	40	104.0	130.0	76.1	14.5	14.5
103140	331.09	G 2	50	40	121.0	165.0	92.4	16.5	16.5

→ The additional PTFE sealing disc minimizes the wear with frequent use.

Ball valves with steel lever

Standard type, with full bore

PLUS

Applications: Compressed air, water, non-toxic and non-corrosive gases, heating systems, agriculture.

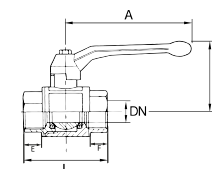

Material	Nickel-plated brass
Ball	Chrome-plated brass
Ball seal	PTFE
Stem seal	2 O-rings HNBR/EPDM peroxide crosslinked, sealing ring PTFE
Hand lever	Steel, with plastic coating
Operating temperature	-15 to 90 °C
Thread material	Brass with a bare metal surface
Standard thread	G thread acc. to DIN EN ISO 228-1

Ball valve with black steel lever, standard type, female/female thread

Art. No.	Type No.	Thread	DN	PN bar	L mm	A mm	B mm	E mm	F mm
103157	330.02-S	G 1/4	8	63	46.0	85.0	37.2	12.0	12.0
103158	330.03-S	G 3/8	10	63	50.0	85.0	37.2	12.0	12.0
103159	330.04-S	G 1/2	15	40	50.0	85.0	44.1	9.5	9.5
103160	330.05-S	G 3/4	20	40	58.0	105.0	48.4	10.5	10.5
103161	330.06-S	G 1	25	40	69.0	105.0	52.3	12.0	12.0
103162	330.07-S	G 1 1/4	32	40	80.0	130.0	63.1	13.5	13.5
103163	330.08-S	G 1 1/2	40	40	91.5	130.0	69.1	14.5	14.5
103164	330.09-S	G 2	50	40	109.0	165.0	83.4	16.5	16.5
103165	330.10-S	G 2 1/2	65	40	133.0	248.0	97.0	18.5	18.5
103166	330.11-S	G 3	80	40	156.0	248.0	108.0	18.5	18.5



330.04-S



Ball valve with red steel lever, standard type, female/female thread

Art. No.	Type No.	Thread	DN	PN bar	L mm	A mm	B mm	E mm	F mm
103167	330.02-R	G 1/4	8	63	46.0	85.0	37.2	12.0	12.0
103168	330.03-R	G 3/8	10	63	50.0	85.0	37.2	12.0	12.0
103169	330.04-R	G 1/2	15	40	50.0	85.0	44.1	9.5	9.5
103170	330.05-R	G 3/4	20	40	58.0	105.0	48.4	10.5	10.5
103171	330.06-R	G 1	25	40	69.0	105.0	52.3	12.0	12.0
103172	330.07-R	G 1 1/4	32	40	80.0	130.0	63.1	13.5	13.5
103173	330.08-R	G 1 1/2	40	40	91.5	130.0	69.1	14.5	14.5
103174	330.09-R	G 2	50	40	109.0	165.0	83.4	16.5	16.5
103175	330.10-R	G 2 1/2	65	40	133.0	248.0	97.0	18.5	18.5
103176	330.11-R	G 3	80	40	156.0	248.0	108.0	18.5	18.5



330.04-R

Ball valve with blue steel lever, standard type, female/female thread

Art. No.	Type No.	Thread	DN	PN bar	L mm	A mm	B mm	E mm	F mm
103177	330.02-B	G 1/4	8	63	46.0	85.0	37.2	12.0	12.0
103178	330.03-B	G 3/8	10	63	50.0	85.0	37.2	12.0	12.0
103179	330.04-B	G 1/2	15	40	50.0	85.0	44.1	9.5	9.5
103180	330.05-B	G 3/4	20	40	58.0	105.0	48.4	10.5	10.5
103181	330.06-B	G 1	25	40	69.0	105.0	52.3	12.0	12.0
103182	330.07-B	G 1 1/4	32	40	80.0	130.0	63.1	13.5	13.5
103183	330.08-B	G 1 1/2	40	40	91.5	130.0	69.1	14.5	14.5
103184	330.09-B	G 2	50	40	109.0	165.0	83.4	16.5	16.5
103185	330.10-B	G 2 1/2	65	40	133.0	248.0	97.0	18.5	18.5
103186	330.11-B	G 3	80	40	156.0	248.0	108.0	18.5	18.5



330.04-B

Ball valve with yellow steel lever, standard type, female/female thread

Art. No.	Type No.	Thread	DN	PN bar	L mm	A mm	B mm	E mm	F mm
103187	330.02-G	G 1/4	8	63	46.0	85.0	37.2	12.0	12.0
103188	330.03-G	G 3/8	10	63	50.0	85.0	37.2	12.0	12.0
103189	330.04-G	G 1/2	15	40	50.0	85.0	44.1	9.5	9.5



330.04-G

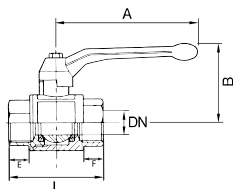

Ball valves with steel lever

Standard type, with full bore

PLUS

Ball valve with yellow steel lever, standard type, female/female thread

Art. No.	Type No.	Thread	DN	PN bar	L mm	A mm	B mm	E mm	F mm
103190	330.05-G	G 3/4	20	40	58.0	105.0	48.4	10.5	10.5
103191	330.06-G	G 1	25	40	69.0	105.0	52.3	12.0	12.0
103192	330.07-G	G 1 1/4	32	40	80.0	130.0	63.1	13.5	13.5
103193	330.08-G	G 1 1/2	40	40	91.5	130.0	69.1	14.5	14.5
103194	330.09-G	G 2	50	40	109.0	165.0	83.4	16.5	16.5



331.05-S

Ball valve with black steel lever, standard type, female/male thread

Art. No.	Type No.	Thread	DN	PN bar	L mm	A mm	B mm	E mm	F mm
103195	331.02-S	G 1/4	8	63	51.0	85.0	37.2	9.4	12.0
103196	331.03-S	G 3/8	10	63	53.0	85.0	37.2	8.6	12.0
103197	331.04-S	G 1/2	15	40	59.8	85.0	44.1	9.5	9.5
103198	331.05-S	G 3/4	20	40	69.5	105.0	48.4	10.5	10.5
103199	331.06-S	G 1	25	40	78.8	105.0	52.3	12.0	12.0
103200	331.07-S	G 1 1/4	32	40	91.5	130.0	63.1	13.0	13.5
103201	331.08-S	G 1 1/2	40	40	104.0	130.0	69.1	14.5	14.5
103202	331.09-S	G 2	50	40	121.0	165.0	83.4	16.5	16.5



331.05-R

Ball valve with red steel lever, standard type, female/male thread

Art. No.	Type No.	Thread	DN	PN bar	L mm	A mm	B mm	E mm	F mm
103203	331.02-R	G 1/4	8	63	51.0	85.0	37.2	9.4	12.0
103204	331.03-R	G 3/8	10	63	53.0	85.0	37.2	8.6	12.0
103205	331.04-R	G 1/2	15	40	59.8	85.0	44.1	9.5	9.5
103206	331.05-R	G 3/4	20	40	69.5	105.0	48.4	10.5	10.5
103207	331.06-R	G 1	25	40	78.8	105.0	52.3	12.0	12.0
103208	331.07-R	G 1 1/4	32	40	91.5	130.0	63.1	13.0	13.5
103209	331.08-R	G 1 1/2	40	40	104.0	130.0	69.1	14.5	14.5
103210	331.09-R	G 2	50	40	121.0	165.0	83.4	16.5	16.5



331.05-B

Ball valve with blue steel lever, standard type, female/male thread

Art. No.	Type No.	Thread	DN	PN bar	L mm	A mm	B mm	E mm	F mm
103211	331.02-B	G 1/4	8	63	51.0	85.0	37.2	9.4	12.0
103212	331.03-B	G 3/8	10	63	53.0	85.0	37.2	8.6	12.0
103213	331.04-B	G 1/2	15	40	59.8	85.0	44.1	9.5	9.5
103214	331.05-B	G 3/4	20	40	69.5	105.0	48.4	10.5	10.5
103215	331.06-B	G 1	25	40	78.8	105.0	52.3	12.0	12.0
103216	331.07-B	G 1 1/4	32	40	91.5	130.0	63.1	13.0	13.5
103217	331.08-B	G 1 1/2	40	40	104.0	130.0	69.1	14.5	14.5
103218	331.09-B	G 2	50	40	121.0	165.0	83.4	16.5	16.5



331.05-G

Ball valve with yellow steel lever, standard type, female/male thread

Art. No.	Type No.	Thread	DN	PN bar	L mm	A mm	B mm	E mm	F mm
103219	331.02-G	G 1/4	8	63	51.0	85.0	37.2	9.4	12.0
103220	331.03-G	G 3/8	10	63	53.0	85.0	37.2	8.6	12.0
103221	331.04-G	G 1/2	15	40	59.8	85.0	44.1	9.5	9.5
103222	331.05-G	G 3/4	20	40	69.5	105.0	48.4	10.5	10.5
103223	331.06-G	G 1	25	40	78.8	105.0	52.3	12.0	12.0
103224	331.07-G	G 1 1/4	32	40	91.5	130.0	63.1	13.0	13.5
103225	331.08-G	G 1 1/2	40	40	104.0	130.0	69.1	14.5	14.5
103226	331.09-G	G 2	50	40	121.0	165.0	83.4	16.5	16.5

→ The additional PTFE sealing disc minimizes the wear with frequent use.

Ball valves

long-threaded type

PLUS

Applications: Compressed air, water, non-toxic and non-corrosive gases, heating systems, agriculture.

Material	Nickel-plated brass
Ball	Chrome-plated brass
Ball seal	PTFE
Stem seal	HNBR / EPDM / PTFE
Hand lever	Aluminium, painted black
Operating temperature	-15 to 90 °C
Max. operating pressure	40 bar
Thread material	Brass with a bare metal surface
Standard thread	Thread acc. to ISO 7-1

Ball valve, long-threaded type, female/female thread

Art. No.	Type No.	Thread	DN	L mm	A mm	B mm
103235	336.02	Rp 1/4	8	46.0	85.0	42.0
103236	336.03	Rp 3/8	10	50.0	85.0	42.0
103237	336.04	Rp 1/2	15	61.0	85.0	46.0
103238	336.05	Rp 3/4	20	70.0	105.0	53.0
103239	336.06	Rp 1	25	84.0	105.0	57.0
103240	336.07	Rp 1 1/4	32	97.0	130.0	70.0
103241	336.08	Rp 1 1/2	40	108.0	130.0	76.0
103242	336.09	Rp 2	50	130.0	165.0	92.0

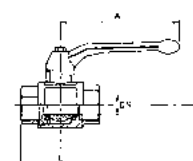

336.05



Ball valve, long-threaded type, female/male thread

Art. No.	Type No.	Thread	DN	L mm	A mm	B mm
103245	337.02	Rp/R 1/4	8	51.0	85.0	42.0
103246	337.03	Rp/R 3/8	10	54.0	85.0	42.0
103247	337.04	Rp/R 1/2	15	67.0	85.0	46.0
103248	337.05	Rp/R 3/4	20	78.0	105.0	53.0
103249	337.06	Rp/R 1	25	89.0	105.0	57.0
103250	337.07	Rp/R 1 1/4	32	103.0	130.0	70.0
103251	337.08	Rp/R 1 1/2	40	113.0	130.0	76.0
103252	337.09	Rp/R 2	50	136.0	165.0	92.0

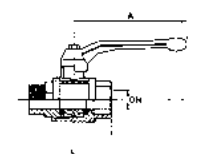

337.04

- The pressure values refer to a maximum operating temperature of 40 °C. Lower maximum pressure apply at higher temperatures.
- Regardless of the (PN 63) operating pressure marked on the device, the ball valve must not be operated at more than PN 40 bar.

Ball valves

heavy-duty type - with full bore

MAX

Applications: Compressed air, water, neutral and non-toxic gases, fuel oil (light distillate), fuel oil (heavy), lubricating oils, diesel oils.

Housing	Nickel-plated brass
Ball	Chrome-plated brass
Ball seal	PTFE
Stem seal	PTFE
Hand lever	Aluminium, painted black
Operating temperature	-20 to 130 °C
Thread material	Brass with a bare metal surface

Ball valve with hand lever, female/female thread

Art. No.	Type No.	Thread	DN	PN bar	a/f mm	L mm	A mm	B mm	E mm	F mm
103261	3350.02	G 1/4	8	80	18	40.5	75.0	51.5	6.5	6.5
103262	3350.03	G 3/8	10	80	21	46.0	75.0	54.0	8.5	8.5
103263	3350.04	G 1/2	15	80	26	55.0	100.0	64.0	9.5	9.5
103264	3350.05	G 3/4	20	80	32	65.0	120.0	67.5	12.5	12.5
103265	3350.06	G 1	25	80	39	76.0	120.0	80.0	13.5	13.5
103266	3350.07	G 1 1/4	32	80	49	85.0	150.0	94.0	13.5	13.5
103267	3350.08	G 1 1/2	40	80	56	103.0	150.0	103.0	18.0	18.0
103268	3350.09	G 2	50	63	69	121.0	175.0	115.5	20.5	20.5
103269	3350.10	G 2 1/2	65	40	85	148.0	280.0	152.0	24.2	24.2
103270	3350.11	G 3	80	40	100	172.0	280.0	163.5	26.8	26.8

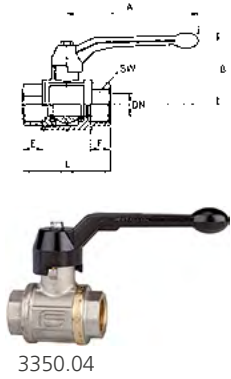

Ball valve with hand lever, female/male thread

Art. No.	Type No.	Thread	DN	PN bar	a/f 1 mm	a/f 2 mm	L mm	A mm	B mm	E mm	F mm
103271	3350.22	G/R 1/4	8	80	18	18	49.0	75.0	51.5	11.0	7.0
103272	3350.33	G/R 3/8	10	80	21	21	56.0	75.0	54.0	11.0	8.5
103273	3350.44	G/R 1/2	15	80	26	27	68.0	100.0	64.0	14.9	8.5
103274	3350.55	G/R 3/4	20	80	32	33	77.0	100.0	68.0	16.0	14.0
103275	3350.66	G/R 1	25	80	39	40	89.0	120.0	80.0	19.0	15.0
103276	3350.77	G/R 1 1/4	32	80	49	50	100.0	150.0	95.0	21.2	16.0
103277	3350.88	G/R 1 1/2	40	80	56	57	114.5	150.0	103.0	21.2	18.0
103278	3350.99	G/R 2	50	63	69	70	136.0	175.0	115.5	25.5	21.0

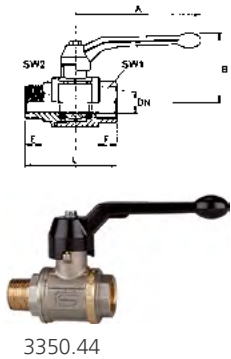

Ball valve with hand lever, male/male thread

Art. No.	Type No.	Thread	DN	PN bar	a/f mm	L mm	A mm	B mm	E mm	F mm
103279	3351.22	R 1/4	8	100	18	54.5	75.0	51.5	10.9	10.9
103280	3351.33	R 3/8	10	100	22	66.0	100.0	61.0	11.2	11.2
103281	3351.44	R 1/2	15	100	27	82.0	100.0	64.0	14.9	14.9
103282	3351.55	R 3/4	20	100	33	95.0	120.0	76.0	16.0	16.0
103283	3351.66	R 1	25	100	40	107.0	120.0	80.0	19.0	19.0
103284	3351.77	R 1 1/4	32	100	50	122.4	150.0	96.4	21.2	21.2
103285	3351.88	R 1 1/2	40	100	57	136.0	150.0	102.9	21.2	21.2
103286	3351.99	R 2	50	80	70	159.5	175.0	117.8	25.0	25.0

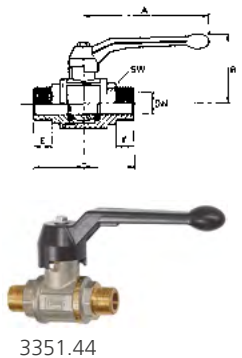

Ball valves

heavy-duty type - with full bore

MAX

Applications: Compressed air, water, neutral and non-toxic gases, fuel oil (light distillate), fuel oil (heavy), lubricating oils, diesel oils.

Housing	Nickel-plated brass
Ball	Chrome-plated brass
Ball seal	PTFE
Stem seal	PTFE
Butterfly handle	Aluminium, painted black
Operating temperature	-20 to 130 °C
Thread material	Brass with a bare metal surface

Ball valve with butterfly handle, female/female thread

Art. No.	Type No.	Thread	DN	PN bar	a/f mm	L mm	A mm	B mm	E mm	F mm
103287	3340.02	G 1/4	8	80	18	40.5	45.0	43.0	6.5	6.5
103288	3340.03	G 3/8	10	80	21	46.0	45.0	46.0	8.5	8.5
103289	3340.04	G 1/2	15	80	26	55.0	55.0	54.5	9.5	9.5
103290	3340.05	G 3/4	20	80	32	65.0	55.0	59.0	12.5	12.5
103291	3340.06	G 1	25	80	39	76.0	70.0	73.0	13.5	13.5

Ball valve with butterfly handle, female/male thread

Art. No.	Type No.	Thread	DN	PN bar	a/f 1 mm	a/f 2 mm	L mm	A mm	B mm	E mm	F mm
103292	3340.12	G/R 1/4	8	80	18	18	49.0	45.0	43.0	11.0	7.0
103293	3340.13	G/R 3/8	10	80	21	21	56.0	45.0	45.5	11.0	9.0
103294	3340.14	G/R 1/2	15	80	27	26	68.0	55.0	54.5	15.0	8.0
103295	3340.15	G/R 3/4	20	80	33	32	77.0	55.0	58.5	16.0	13.0
103296	3340.16	G/R 1	25	80	40	39	88.4	70.0	70.5	19.0	14.5

Ball valve with butterfly handle, male/male thread

Art. No.	Type No.	Thread	DN	PN bar	a/f mm	L mm	A mm	B mm	E mm	F mm
103297	3340.32	R 1/4	8	100	18	54.5	45.0	43.0	11.0	11.0
103298	3340.33	R 3/8	10	100	21	66.0	45.0	51.0	11.2	11.2
103299	3340.34	R 1/2	15	100	27	82.0	55.0	54.5	14.9	14.9
103300	3340.35	R 3/4	20	100	33	94.0	55.0	66.0	16.1	16.1
103301	3340.36	R 1	25	100	40	107.0	70.0	70.0	19.0	19.0

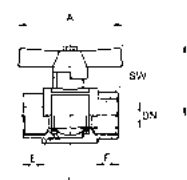

3340.04

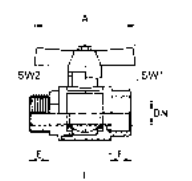

3340.14

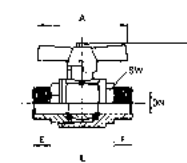

3340.34



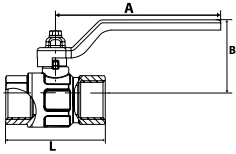

Gas ball valves

acc. to DIN EN 331 - with DIN DVGW approval for gas applications



Ball valves with full bore, for gas installations. Applications: Natural gas, LPG, town gas

Housing	Nickel-plated brass
Ball	Chrome-plated brass
Ball seal	PTFE
Operating temperature	-15 °C to 60 °C for gas
Operating pressure	max. 5 bar (pressure class MOP 5 acc. to DIN EN 331)
Thread material	Brass
Standard thread	Thread acc. to ISO 7-1

Ball valve with hand lever, DIN DVGW for gas, female/female thread



Art. No.	Type No.	Thread	DN	L mm	A mm	B mm	Stem seal
133169	350.1101	Rp 1/4	8	45.7	85.0	42.0	PTFE / NBR
133170	350.1102	Rp 3/8	10	48.6	85.0	41.7	PTFE / EPDM / HNBR
133171	350.1103	Rp 1/2	15	61.1	85.0	46.0	PTFE / EPDM / HNBR
133172	350.1104	Rp 3/4	20	69.6	105.0	53.0	PTFE / EPDM / HNBR
133173	350.1105	Rp 1	25	83.5	105.0	57.0	PTFE / EPDM / HNBR
133174	350.1106	Rp 1 1/4	32	96.8	130.0	70.0	PTFE / EPDM / HNBR
133175	350.1107	Rp 1 1/2	40	107.7	130.0	76.0	PTFE / EPDM / HNBR
133176	350.1108	Rp 2	50	129.8	165.0	92.0	PTFE / EPDM / HNBR

Ball valve with hand lever, DIN DVGW for gas, female/male thread



Art. No.	Type No.	Thread	DN	L mm	A mm	B mm	Stem seal
133179	350.1111	Rp/R 1/4	8	51.4	85.0	42.0	PTFE / NBR
133180	350.1112	Rp/R 3/8	10	53.6	85.0	41.7	PTFE / EPDM / HNBR
133181	350.1113	Rp/R 1/2	15	67.0	85.0	46.0	PTFE / EPDM / HNBR
133182	350.1114	Rp/R 3/4	20	78.0	105.0	53.0	PTFE / EPDM / HNBR
133183	350.1115	Rp/R 1	25	89.0	105.0	57.0	PTFE / EPDM / HNBR
133184	350.1116	Rp/R 1 1/4	32	103.0	130.0	70.0	PTFE / EPDM / HNBR
133185	350.1117	Rp/R 1 1/2	40	113.0	130.0	76.0	PTFE / EPDM / HNBR
133186	350.1118	Rp/R 2	50	134.5	165.0	92.0	PTFE / EPDM / HNBR

Ball valve with butterfly handle, DIN DVGW for gas, female/female thread

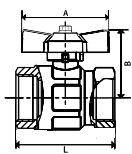

Art. No.	Type No.	Thread	DN	L mm	A mm	B mm	Stem seal
133187	350.1121	Rp 1/4	8	45.7	47.0	30.0	PTFE / NBR
133188	350.1122	Rp 3/8	10	48.6	47.0	30.6	PTFE / EPDM / HNBR
133189	350.1123	Rp 1/2	15	61.1	47.0	36.0	PTFE / EPDM / HNBR
133190	350.1124	Rp 3/4	20	69.6	56.0	42.0	PTFE / EPDM / HNBR
133191	350.1125	Rp 1	25	83.5	56.0	46.0	PTFE / EPDM / HNBR

Ball valve with butterfly handle, DIN DVGW for gas, female/male thread



Art. No.	Type No.	Thread	DN	L mm	A mm	B mm	Stem seal
133192	350.1131	Rp/R 1/4	8	51.4	47.0	31.0	PTFE / NBR
133193	350.1132	Rp/R 3/8	10	53.6	47.0	30.6	PTFE / EPDM / HNBR
133194	350.1133	Rp/R 1/2	15	67.0	47.0	36.0	PTFE / EPDM / HNBR
133195	350.1134	Rp/R 3/4	20	78.0	56.0	42.0	PTFE / EPDM / HNBR
133196	350.1135	Rp/R 1	25	89.0	56.0	46.0	PTFE / EPDM / HNBR

➔ Regardless of the PN 63 bar or PN 40 bar operating pressure marked on the device, the ball valve may only be used up to max. 5 bar for gas applications.

Angle-type ball valves

Gas ball valves acc. to DIN EN 331 with DIN DVGW



Housing	Nickel-plated brass
Internal parts	Nickel-plated brass
Butterfly handle	Aluminium, painted yellow
Ball seal	PTFE
Stem seal	NBR
Operating temperature	-15 °C to 60 °C for gas, -15 °C to 100 °C for liquids
Operating pressure	max. 5 bar (MOP 5) gas, max. 40 bar liquids
Applications	Gas, compressed air, water, oil
Thread material	Brass with a bare metal surface



Ball valve, angle type, female/female thread

Art. No.	Type No.	Thread	DN	A mm	B mm	F mm	E mm	C Ø mm
103310	350.203	Rp 1/2	15	47.0	38.0	33.0	31.0	31.0
103311	350.204	Rp 3/4	20	56.0	46.0	38.0	35.0	39.0
103312	350.205	Rp 1	25	56.0	50.0	46.0	42.0	48.0



350.203

Ball valve, angle type, female/male thread (male thread on side)

Art. No.	Type No.	Thread	DN	A mm	B mm	F mm	E mm	C Ø mm
103313	350.303	R/Rp 1/2	15	47.0	37.0	33.0	37.0	31.0
103314	350.304	R/Rp 3/4	20	56.0	46.0	38.0	43.0	38.9
103315	350.305	R/Rp 1	25	56.0	50.0	46.0	51.0	48.0

Ball valve, angle type, male/male thread

Art. No.	Type No.	Thread	DN	A mm	B mm	F mm	E mm	C Ø mm
103316	350.403	R 1/2	15	47.0	38.0	35.0	37.0	31.0
103317	350.404	R 3/4	20	56.0	46.0	40.0	43.0	38.5
103318	350.405	R 1	25	56.0	50.0	48.0	51.0	48.0



Potable water ball valves



Brass ball valve with free flow, DVGW approved. This valve complies with the European standard EN 13828 and the working paper DVGW W 570, and is therefore approved for use with drinking water. The special ball technology prevents bacteria from forming inside the valve if it is not in use for a long period of time (i. e. the valve is absolutely safe for drinking water).

Housing	Nickel-plated brass (outside), brass (inside)
Ball	Chrome-plated brass
Ball seal	PTFE
Stem seal	PTFE / EPDM / HNBR
Thread material	Brass
Hand lever	Aluminium
Operating temperature	-15 to 110 °C
Applications	Potable water, water
Standard thread	Thread acc. to DIN EN ISO 228-1

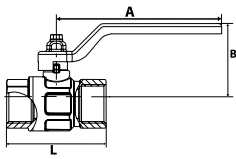

350.7703

Potable water ball valve with hand lever, female/female thread

Art. No.	Type No.	Thread	DN	PN bar	L mm	A mm	B mm
133161	350.7701	G 1/4	8	50	46.0	85.0	42.0
133162	350.7702	G 3/8	10	50	50.0	85.0	42.0
133163	350.7703	G 1/2	15	40	50.0	85.0	45.8
133164	350.7704	G 3/4	20	40	58.0	105.0	53.4
133165	350.7705	G 1	25	40	69.0	105.0	57.3
133166	350.7706	G 1 1/4	32	40	80.0	130.0	70.1
133167	350.7707	G 1 1/2	40	40	91.5	130.0	76.1
133168	350.7708	G 2	50	40	119.0	165.0	92.4

Ball valves

Stainless steel, 2-piece - standard type, lockable

Housing	Stainless steel 1.4408
Ball	Stainless steel 1.4401
Ball seal	PTFE (15 % glass fibre reinforced)
Stem seal	PTFE
Hand lever	Stainless steel 1.4301, with plastic coating
Operating temperature	-20 to 180 °C
Standard thread	G thread acc. to DIN EN ISO 228-1
Bore diameter padlock	ca. 6.0 mm

Stainless steel ball valve, 2-piece, female/female thread, with full bore

Art. No.	Type No.	Thread	DN	PN bar	L mm	A mm	B mm
135892	3395.01	G 1/4	8	63	48.0	95.0	50.0
135893	3395.02	G 3/8	10	63	48.0	95.0	50.0
135894	3395.03	G 1/2	15	63	56.0	105.0	61.5
135895	3395.04	G 3/4	20	63	65.0	115.0	67.5
135896	3395.05	G 1	25	63	75.0	125.0	69.0
135897	3395.06	G 1 1/4	32	63	88.0	150.0	84.5
135898	3395.07	G 1 1/2	38	63	98.0	170.0	103.5
135899	3395.08	G 2	50	63	110.0	170.0	111.0
135900	3395.09	G 2 1/2	65	40	138.0	240.0	135.0
135901	3395.10	G 3	80	40	164.0	240.0	145.0

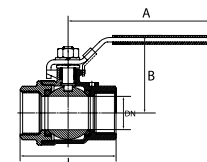

3395.05

Stainless steel ball valve, 2-piece, female/male thread, slightly reduced

Art. No.	Type No.	Thread	DN	PN bar	L mm	A mm	B mm	C Ø mm
135902	3395.21	G 1/4	8	63	58.0	95.0	50.0	10.0
135903	3395.22	G 3/8	10	63	58.0	95.0	50.0	10.0
135904	3395.23	G 1/2	15	63	68.0	105.0	61.5	15.0
135905	3395.24	G 3/4	20	63	75.0	115.0	67.5	20.0
135906	3395.25	G 1	25	63	85.0	125.0	69.0	25.0
135907	3395.26	G 1 1/4	32	63	100.0	150.0	84.5	32.0
135908	3395.27	G 1 1/2	40	63	112.0	170.0	103.5	38.0
135909	3395.28	G 2	50	63	123.0	170.0	111.0	49.0

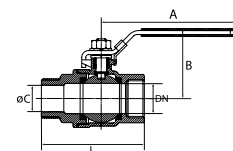

3395.25

→ Padlock see page 292

3

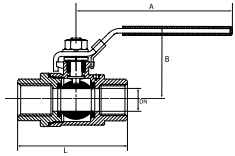

Ball valves

Stainless steel, 2-piece - length acc. to DIN 3202-M3, lockable

Housing	Stainless steel 1.4408
Ball	Stainless steel 1.4401
Ball seal	PTFE (15 % glass fibre reinforced)
Stem seal	PTFE
Hand lever	Stainless steel 1.4301, with plastic coating
Operating pressure	max. 63 bar (dependent on temperature)
Operating temperature	-20 to 180 °C
Standard thread	G thread acc. to DIN EN ISO 228-1
Bore diameter padlock	ca. 7.5 mm



Stainless steel ball valve, 2-piece, length acc. to DIN 3202-M3, with full bore

Art. No.	Type No.	Thread	DN	L mm	A mm	B mm
135351	397.01	G 1/4	11.6	50.0	105.0	44.0
135352	397.02	G 3/8	12.5	60.0	105.0	44.0
135353	397.03	G 1/2	15	75.0	105.0	50.0
135354	397.04	G 3/4	20	80.0	105.0	59.0
135355	397.05	G 1	25	90.0	137.0	65.0
135356	397.06	G 1 1/4	32	110.0	137.0	79.0
135357	397.07	G 1 1/2	38	120.0	182.0	86.0
135358	397.08	G 2	50	140.0	182.0	99.0

→ Padlock see page 292

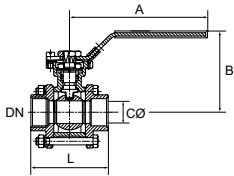

Ball valves

Stainless steel, 3-piece - length acc. to DIN 3202-M3, lockable

Housing	Stainless steel 1.4408
Ball	Stainless steel 1.4401
Ball seal	PTFE (15 % glass fibre reinforced)
Stem seal	PTFE
Hand lever	Stainless steel 1.4301, with plastic coating
Operating temperature	-20 to 180 °C
Standard thread	G thread acc. to DIN EN ISO 228-1, flange plate ISO 5211
Bore diameter padlock	ca. 7.7 mm



Stainless steel ball valve, 3-piece, length acc. to DIN 3202-M3, with full bore

Art. No.	Type No.	Thread	DN	PN bar	L mm	A mm	B mm	ISO 5211
135910	3390.01	G 1/4	8	63	60.0	125.0	68.5	F 03 / F 04
135911	3390.02	G 3/8	10	63	60.0	125.0	68.5	F 03 / F 04
135912	3390.03	G 1/2	15	63	75.0	125.0	77.5	F 03 / F 04
135913	3390.04	G 3/4	20	63	80.0	125.0	81.5	F 03 / F 04
135914	3390.05	G 1	25	63	90.0	150.0	88.5	F 04 / F 05
135915	3390.06	G 1 1/4	32	63	110.0	150.0	93.5	F 04 / F 05
135916	3390.07	G 1 1/2	40	63	120.0	190.0	113.5	F 05 / F 07
135917	3390.08	G 2	50	63	140.0	190.0	120.5	F 05 / F 07
135918	3390.09	G 2 1/2	65	40	185.0	350.0	125.0	F 07 / F 10
135919	3390.10	G 3	80	40	205.0	350.0	136.0	F 07 / F 10

→ Padlock see page 292

Ball valves

stainless steel , 3-piece with weld-on ends, length acc. to DIN 3202-S13, lockable

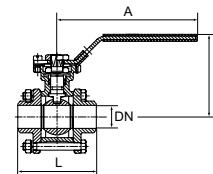

Housing	Stainless steel 1.4408
Ball	Stainless steel 1.4408
Ball seal	RPTFE (15 % glass fibre reinforced)
Stem seal	RPTFE (15 % glass fibre reinforced)
Hand lever	Stainless steel 1.4301, with plastic coating
Operating temperature	-20 to 150 °C
Operating pressure	max. 63 bar (dependent on temperature)
Bore diameter padlock	ca. 7.5 mm

Ball valve, 3-piece, with full bore

Art. No.	Type No.	L mm	A mm	B mm	ISO 5211
103455	391.01	70.0	123.0	74.0	F 03 / F 04
103456	391.02	70.0	123.0	74.0	F 03 / F 04
103457	391.03	75.0	123.0	74.0	F 03 / F 04
103458	391.04	90.0	123.0	78.0	F 03 / F 04
103459	391.05	100.0	152.0	89.0	F 04 / F 05
103460	391.06	110.0	152.0	94.0	F 04 / F 05
103461	391.07	125.0	182.0	110.0	F 05 / F 07
103462	391.08	150.0	182.0	118.0	F 05 / F 07



- Padlock see page 292
- With ISO flange plate (acc. to ISO 5211)
- the welding ends are welded butt to butt with the pipe



Ball valves

stainless steel, 1-piece

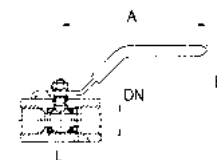

Housing	Stainless steel 1.4401/1.4408
Ball	Stainless steel 1.4401
Ball seal	RPTFE (15 % glass fibre reinforced)
Stem seal	PTFE
Hand lever	Stainless steel 1.4301, with plastic coating
Operating temperature	-20 to 150 °C
Operating pressure	max. 63 bar (dependent on temperature)
Standard thread	G thread acc. to DIN EN ISO 228-1

Stainless steel ball valve, 1-piece, with reduced bore

Art. No.	Type No.	Thread	DN	L mm	A mm	B mm
103423	398.02	G 1/4	8	39.8	60.0	30.0
103424	398.03	G 3/8	10	44.8	80.0	33.0
103425	398.04	G 1/2	15	56.5	110.0	57.0
103426	398.05	G 3/4	20	60.0	110.0	61.0
103427	398.06	G 1	25	70.0	124.0	70.0
103428	398.07	G 1 1/4	32	77.6	152.0	75.0
103429	398.08	G 1 1/2	40	87.0	150.0	80.0
103430	398.09	G 2	50	102.0	155.0	85.0



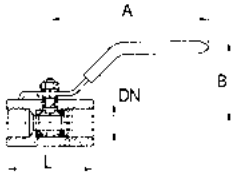

Ball valves

stainless steel, 1-piece - mini series

Housing	Stainless steel 1.4401/1.4408
Ball	Stainless steel 1.4408
Ball seal	RPTFE (15 % glass fibre reinforced)
Stem seal	PTFE
Hand lever	Stainless steel 1.4301, with plastic coating
Operating temperature	-20 to 150 °C
Operating pressure	max. 63 bar (dependent on temperature)
Standard thread	G thread acc. to DIN EN ISO 228-1



374.01-ES

Ball valve, mini series, with reduced bore

Art. No.	Type No.	Thread	DN	L mm	A mm	B mm
103477	374.01-ES	G 1/4	8	46.5	62.0	30.0
103478	374.02-ES	G 3/8	10	51.0	82.0	30.0
103479	374.03-ES	G 1/2	15	64.0	92.0	45.0
103480	374.04-ES	G 3/4	20	68.0	94.0	50.0

Ball valves

stainless steel, 1-piece - mini series

Housing	Stainless steel 1.4408
Ball	Stainless steel 1.4408
Ball seal	RPTFE (15 % glass fibre reinforced)
Stem seal	RPTFE (15 % glass fibre reinforced)
Hand lever	Stainless steel 1.4301, with plastic coating
Operating temperature	-20 to 150 °C
Operating pressure	max. 63 bar (dependent on temperature)
Standard thread	G thread acc. to DIN EN ISO 228-1



375.01-ES

Ball valve, mini series, with reduced bore

Art. No.	Type No.	Thread	DN	L mm	A mm	B mm
103481	375.01-ES	G 1/4	8	39.0	69.0	34.0
103482	375.02-ES	G 3/8	10	44.0	83.0	38.0
103483	375.03-ES	G 1/2	15	59.0	96.0	41.0
103484	375.04-ES	G 3/4	20	60.0	96.0	45.0
103485	375.05-ES	G 1	25	72.0	116.0	52.0
103486	375.06-ES	G 1 1/4	32	77.0	116.0	57.0
103487	375.07-ES	G 1 1/2	40	84.0	158.0	62.0
103488	375.08-ES	G 2	50	100.0	158.0	68.0

Safety ball valves

non-lockable, with relief port

PLUS

Brass safety ball valves.
Specially designed for pneumatic applications.
The ball valve shuts off the supply side and relieves the application into the atmosphere.

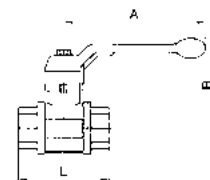

Housing	Nickel-plated brass
Ball	Nickel-plated brass
Stem	Nickel-plated brass
Stuffing box	Nickel-plated brass
Hand lever	Die-cast aluminium, black
Sealant	PTFE
Operating temperature	0 to 60 °C
Max. operating pressure	12 bar
Thread material	Brass with a bare metal surface
Standard thread	Rp thread acc. to ISO 7-1

Safety ball valve, non-lockable, with relief port

Art. No.	Type No.	Thread	DN	L mm	A mm	B mm
103253	350.501	Rp 1/4	8	52.0	100.0	61.0
103254	350.502	Rp 3/8	10	55.0	100.0	61.0
103255	350.503	Rp 1/2	15	69.0	100.0	64.0
103256	350.504	Rp 3/4	20	77.0	120.0	76.0
103257	350.505	Rp 1	25	89.0	120.0	80.0
103258	350.506	Rp 1 1/4	32	103.0	150.0	98.0
103259	350.507	Rp 1 1/2	40	114.0	150.0	104.0
103260	350.508	Rp 2	50	134.0	175.0	119.0



Safety ball valves

lockable, without relief port

PLUS

2/2-way safety ball valves made of nickel-plated brass.
The ball valve can be locked manually.
Full bore, heavy-duty type.

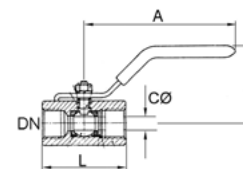

Material	Nickel-plated brass
Hand lever	Steel - PVC coated
Ball seal	PTFE
Stem seal	PTFE
Operating temperature	-40 to 170 °C
Thread material	Nickel-plated brass
Standard thread	Rp thread acc. to EN 10226
Bore diameter padlock	ca. 7.4 mm

Safety ball valve, lockable

Art. No.	Type No.	Thread	DN	PN bar	L mm	A mm	B mm
103141	320.02	Rp 1/4	8	65	51.0	82.0	39.5
103142	320.03	Rp 3/8	10	65	51.0	82.0	39.5
103143	320.04	Rp 1/2	15	65	61.0	100.0	43.0
103144	320.05	Rp 3/4	20	65	74.5	120.0	52.5
103145	320.06	Rp 1	25	65	90.5	120.0	57.0
103146	320.07	Rp 1 1/4	32	40	104.0	158.0	78.0
103147	320.08	Rp 1 1/2	40	40	117.0	158.0	85.0
103148	320.09	Rp 2	50	40	135.0	158.0	92.0



- Attention: The ball valve can suffer serious damage if medium freezes in the system.
- The price does not include a padlock. Please order separately. See page 292

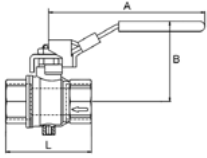

Safety ball valves

lockable with relief port

MAX

Safety ball valves, two parts, made of nickel-plated brass.
Specially designed for pneumatic applications.
The valve shuts off the supply line and bleeds the application area.
Lockable hand lever in closed position ensures a high protection against manipulation.

Housing	Nickel-plated brass
Ball	Chrome-plated brass
Hand lever	Steel - PVC coated
Ball seal	PTFE
Stem seal	FKM
Operating temperature	-10 to 100 °C
Max. operating pressure	14 bar
Thread material	Nickel-plated brass
Standard thread	Rp thread acc. to EN 10226
Relief port	M5
Bore diameter padlock	ca. 7.3 mm



Safety ball valve, lockable, nickel-plated brass with relief port

Art. No.	Type No.	Thread	Relief port	DN	L mm	A mm	B mm
103149	321.02	Rp 1/4	M5	8	45.0	96.0	49.0
103150	321.03	Rp 3/8	M5	10	45.0	96.0	49.0
103151	321.04	Rp 1/2	M5	15	59.0	96.0	51.0
103152	321.05	Rp 3/4	M5	20	64.0	117.0	60.0
103153	321.06	Rp 1	M5	25	81.0	117.0	64.0
103154	321.07	Rp 1 1/4	G 1/4	32	93.0	157.0	80.0
103155	321.08	Rp 1 1/2	G 1/4	40	102.0	157.0	86.0
103156	321.09	Rp 2	G 1/4	50	121.0	157.0	93.0

- ➔ We recommend fitting the relief port with a silencer.
- ➔ For suitable silencers see page 801
- ➔ The price does not include a padlock. Please order separately. See page 292

Safety ball valves

with spring return

MAX

2/2-way safety ball valves, two parts, made of nickel-plated brass with spring return.

The ball valve is closed in the normal position and opens against spring force. High safety standard because the valve is automatically closed if the handle is not operated; inadvertent opening is prevented.

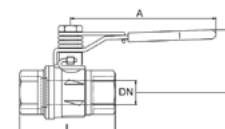

Housing	Nickel-plated brass
Ball	Chrome-plated brass
Hand lever	Steel - PVC coated
Spring	Stainless steel 1.4301
Ball seal	PTFE
Stem seal	FKM
Operating temperature	-40 to 170 °C
Thread material	Nickel-plated brass
Standard thread	Rp thread acc. to ISO 7-1

Safety ball valve with spring return, nickel-plated brass

Art. No.	Type No.	Thread	DN	PN bar	L mm	A mm	B mm
103227	KHF-14	Rp 1/4	8	65	50.0	100.0	40.0
103228	KHF-38	Rp 3/8	10	65	60.0	100.0	40.0
103229	KHF-12	Rp 1/2	15	65	75.0	100.0	43.0
103230	KHF-34	Rp 3/4	20	65	80.0	120.0	51.0
103231	KHF-10	Rp 1	25	65	90.0	120.0	55.0
103232	KHF-114	Rp 1 1/4	32	40	110.0	158.0	75.0
103233	KHF-112	Rp 1 1/2	40	40	120.0	158.0	81.0
103234	KHF-20	Rp 2	50	40	140.0	158.0	88.0



KHF-12



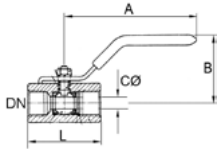

Safety ball valves

lockable, with relief port

Stainless steel safety ball valves.
Specially designed for pneumatic applications.
The ball valve can be locked manually and has a relief port.

Housing	Stainless steel 1.4408
Ball	Stainless steel 1.4408
Hand lever	Stainless steel 1.4301, PVC coated
Ball seal	PTFE + PFA
Stem seal	PTFE
Operating temperature	-20 to 160 °C
Max. operating pressure	17 bar
Standard thread	G thread acc. to DIN EN ISO 228-1
Relief port	M5
Bore diameter padlock	ca. 7.8 mm



3396.06

Stainless steel safety ball valve, lockable, with relief port

Art. No.	Type No.	Thread	DN	L mm	A mm	B mm	C Ø mm
151730	3396.02	G 1/4	8	54.4	103.9	50.0	11.5
151731	3396.03	G 3/8	10	54.4	103.9	50.0	12.5
151732	3396.04	G 1/2	15	65.3	123.0	56.5	15.0
151733	3396.05	G 3/4	20	77.3	123.0	60.5	20.0
151734	3396.06	G 1	25	88.7	145.0	69.3	25.0

- ➔ Regardless of the 1000 WOG (PN 63) operating pressure marked on the device, the relief valve must not be operated at more than PN 17 bar.
- ➔ We recommend fitting the relief port with a silencer (M5 connection).
- ➔ For suitable silencers see page 801
- ➔ The price does not include a padlock. Please order separately. See page 292



VS 37



VS 38

Padlocks

Padlock

Art. No.	Type No.	Description
100273	VS 37	Padlock, band Ø 6 mm
139824	VS 38	Padlock, band Ø 7 mm

Mini ball valves

EASY

Housing	Nickel-plated brass
Ball	Nickel-plated brass
Rotating handle	Plastic
Ball seal	PTFE
Stem seal	NBR
Medium temperature	-10 to 80 °C
Ambient temperature	-10 to 80 °C
Max. operating pressure	10 bar
Thread material	Nickel-plated brass

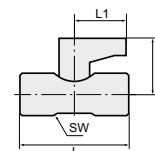

Mini ball valve

Art. No.	Type No.	Thread	DN	a/f mm	L mm	L1 mm	H mm
103319	371.101	G 1/8 IT	6	15	34.0	24.0	23.0
103320	371.102	G 1/4 IT	6	15	38.0	24.0	23.0
103321	371.103	G 3/8 IT	8	17	43.0	24.0	24.0
103322	371.104	G 1/2 IT	10	21	49.0	24.0	27.0
103323	371.201	G 1/8 IT / R 1/8 ET	6	15	34.0	24.0	23.0
103324	371.202	G 1/4 IT / R 1/4 ET	6	15	39.0	24.0	23.0
103325	371.203	G 3/8 IT / R 3/8 ET	8	17	43.0	24.0	24.0
103326	371.204	G 1/2 IT / R 1/2 ET	10	21	50.0	24.0	27.0



371.102



Mini ball valves

EASY

Housing	Nickel-plated brass
Ball	Nickel-plated brass
Rotating handle	Plastic
Ball seal	PTFE
Stem seal	NBR
Medium temperature	-10 to 80 °C
Ambient temperature	-10 to 80 °C
Max. operating pressure	10 bar
Thread material	Nickel-plated brass

Mini ball valve with rotating handle

Art. No.	Type No.	Thread	DN	a/f mm	L mm	L1 mm	H mm
103347	371.01	Rp 1/8 IT	5.5	14	36.5	19.0	21.5
103348	371.02	Rp 1/4 IT	5.5	14	43.0	19.0	21.5
103349	371.02-1	Rp 3/8 IT	7	18	48.0	18.0	22.5
103350	371.02-2	Rp 1/2 IT	10	22	59.0	25.0	32.0
103351	371.03	R/Rp 1/8 ET / 1/8 IT	5.5	14	35.5	19.0	21.5
103352	371.04	R/Rp 1/4 ET / 1/8 IT	5.5	14	38.0	19.0	21.5
103353	371.05	R/Rp 1/4 ET / 1/4 IT	5.5	14	40.5	19.0	21.5
103354	371.06	R/Rp 3/8 ET / 1/4 IT	5.5	14	41.5	19.0	21.5
103355	371.07	R/Rp 3/8 ET / 3/8 IT	8	18	44.5	19.5	22.5
103356	371.09	R/Rp 1/2 ET / 1/2 IT	10	22	55.5	26.5	32.5



371.02

3

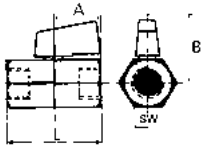

Mini ball valves

with smooth surface

EASY



375.00



375.01

Housing	Nickel-plated brass
Ball	Nickel-plated brass
Rotating handle	Plastic
Ball seal	PTFE
Stem seal	NBR
Medium temperature	-10 to 70 °C (short term up to 90 °C)
Ambient temperature	-10 to 70 °C (short term up to 90 °C)
Max. operating pressure	10 bar
Applications	Compressed air, water, oils, non-toxic gases
Thread material	Nickel-plated brass

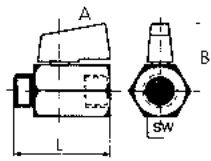

Mini-Ball valve with rotating handle

Art. No.	Type No.	Thread	DN	a/f mm	L mm	A mm	B mm
103339	375.00	G 1/8 IT	8	20	39.0	22.0	27.2
103340	375.01	G 1/4 IT	8	20	39.0	22.0	27.2
103341	375.02	G 3/8 IT	8	20	42.0	22.0	27.2
103342	375.03	G 1/2 IT	10	24	47.0	22.0	29.5
134872	375.04	G 3/4 IT	13.5	30	54.0	22.0	32.0
103343	375.10	G 1/8 IT/ET	8	20	39.0	22.0	27.2
103344	375.11	G 1/4 IT/ET	8	20	39.0	22.0	27.2
103345	375.22	G 3/8 IT/ET	8	20	40.0	22.0	27.2
103346	375.33	G 1/2 IT/ET	10	24	45.0	22.0	29.5
134873	375.44	G 3/4 IT/ET	13.5	30	51.0	22.0	32.0
143656	375.51	G 1/4 ET	8	20	40.4	22.4	27.2
143657	375.52	G 3/8 ET	8	20	42.4	23.4	27.0
143658	375.53	G 1/2 ET	10	24	49.7	28.6	29.5



375.10



375.51

Angle mini ball valves

for panel mounting

PLUS

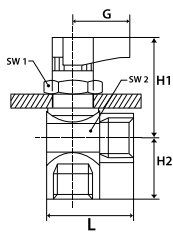

Housing	Chrome-plated brass
Ball	Chrome-plated brass
Rotating handle	PA 66 glass fibre-reinforced
Ball seal	PTFE
Stem seal	NBR
Operating temperature	-20 to 80 °C
Operating pressure	-0.99 - 20 bar
Thread material	Nickel-plated brass
Standard thread	G-thread acc. to DIN EN ISO 228-1
Applications	Compressed air, water, oil



380.02

Angle mini ball valve

Art. No.	Type No.	Thread	DN	a/f 1 mm	a/f 2 mm	L mm	G mm	H1 mm	H2 mm
103360	380.01	G 1/8 IT	5	17	17	28.5	19.0	33.5	15.5
103361	380.02	G 1/4 IT	5	17	17	28.5	19.0	33.5	17.5
103362	380.03	G 3/8 IT	7	17	21	31.0	19.0	35.0	19.5

3-way mini ball valves

for panel mounting

PLUS

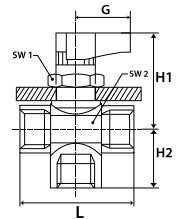

Housing	Chrome-plated brass
Ball	Chrome-plated brass
Rotating handle	PA 66 glass fibre-reinforced
Ball seal	PTFE
Stem seal	NBR
Operating temperature	-20 to 80 °C
Operating pressure	-0.99 - 20 bar
Thread material	Nickel-plated brass
Standard thread	G-thread acc. to DIN EN ISO 228-1
Applications	Compressed air, water, oil

3-way mini ball valve, L-Bore

Art. No.	Type No.	Thread	DN	a/f 1 mm	a/f 2 mm	L mm	G mm	H1 mm	H2 mm
103363	381.01	G 1/8 IT	5	17	17	35.0	19.0	33.5	15.5
103364	381.02	G 1/4 IT	5	17	17	37.0	19.0	33.5	17.5
103365	381.03	G 3/8 IT	7	17	21	42.0	19.0	35.0	19.5



381.02

3-way mini ball valve, T-Bore

Art. No.	Type No.	Thread	DN	a/f 1 mm	a/f 2 mm	L mm	G mm	H1 mm	H2 mm
103366	382.01	G 1/8 IT	5	17	17	35.0	19.0	33.5	15.5
103367	382.02	G 1/4 IT	5	17	17	37.0	19.0	33.5	17.5
103368	382.03	G 3/8 IT	7	17	21	42.0	19.0	35.0	19.5

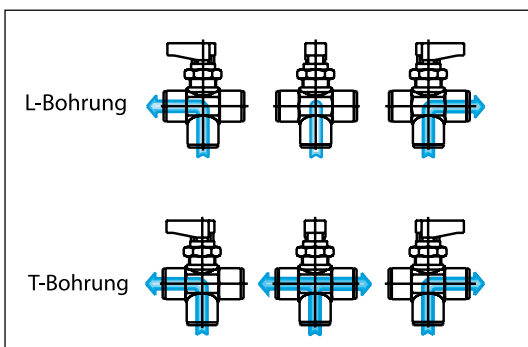

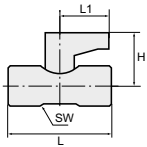

Mini safety ball valves

non-lockable, with relief port

PLUS

Material	Nickel-plated brass
Rotating handle	PA 66
Ball seal	PTFE
Stem seal	NBR
Operating temperature	-20 to 80 °C
Operating pressure	0.99 - 20 bar
Thread material	Nickel-plated brass
Standard thread	G thread acc. to DIN EN ISO 228-1



377.03

Mini safety ball valve, non-lockable, with relief port

Art. No.	Type No.	Thread	DN	Relief port	a/f mm	L mm	L1 mm	H mm
103357	377.01	G 1/8 IT	6	2.5	14 - 15	35.0	19.0	21.0
103358	377.02	G 1/4 IT	6	2.5	14 - 15	37.0	19.0	21.0
103359	377.03	G 3/8 IT	8	3.0	18 - 19	42.0	19.0	21.0

Mini ball valves

sandblasted type

PLUS

Housing	Nickel-plated brass
Ball	Nickel-plated brass
Ball seal	PTFE
Stem seal	FKM
Medium temperature	-10 to 90 °C
Ambient temperature	-10 to 90 °C
Max. operating pressure	10 bar
Applications	Compressed air, water, oils, non-toxic gases
Thread material	Nickel-plated brass

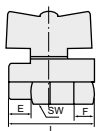

373.01

Ball valve with butterfly handle plastic

Art. No.	Type No.	Thread	a/f mm	DN	L mm	E mm	F mm
103327	373.01	G 1/4 IT	21	8	41.5	9.0	10.5
103328	373.02	G 3/8 IT	21	8	41.5	12.0	10.0
103329	373.03	G 1/2 IT	24	10	47.0	12.5	10.5
103330	373.11	G 1/4 IT/ET	21	8	41.5	9.0	10.5
103331	373.22	G 3/8 IT/ET	21	8	40.5	10.0	10.0
103332	373.33	G 1/2 IT/ET	25	10	46.0	12.0	10.6

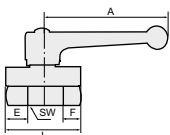

374.01

Ball valve with hand lever plastic

Art. No.	Type No.	Thread	a/f mm	DN	L mm	A mm	E mm	F mm
103333	374.01	G 1/4 IT	21	8	41.5	68.5	9.0	10.5
103334	374.02	G 3/8 IT	21	8	41.5	68.5	12.0	10.0
103335	374.03	G 1/2 IT	25	10	47.0	68.5	12.5	10.5
103336	374.11	G 1/4 IT/ET	20	8	41.5	68.5	9.0	10.5
103337	374.22	G 3/8 IT/ET	21	8	40.5	68.5	10.0	10.0
103338	374.33	G 1/2 IT/ET	25	10	46.5	68.5	12.0	10.6

Mini ball valves

stainless steel

Material	Stainless steel 1.4401 (AISI 316)
Stem	Stainless steel 1.4401 (AISI 316)
Sealant	FKM
Ball seal	PTFE
Rotating handle	Aluminium
Operating temperature	-20 to 120 °C
Max. operating pressure	63 bar

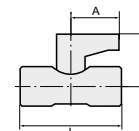

Mini ball valve, stainless steel, female/female thread

Art. No.	Type No.	Thread	DN	L mm	A mm	B mm
103489	376.01-ES	G 1/4	8	40.0	22.8	26.5
103490	376.02-ES	G 3/8	10	42.0	22.8	26.5
103491	376.03-ES	G 1/2	15	46.0	22.8	28.3



376.01-ES

Mini ball valve, stainless steel, female/male thread

Art. No.	Type No.	Thread	DN	L mm	A mm	B mm
103492	377.01-ES	G 1/4	8	40.0	22.8	26.5
103493	377.02-ES	G 3/8	10	42.0	22.8	26.5
103494	377.03-ES	G 1/2	15	46.0	22.8	28.3



377.01-ES

Mini ball valve, stainless steel, male/male thread

Art. No.	Type No.	Thread	DN	L mm	A mm	B mm
103495	379.01-ES	G 1/4	8	50.0	22.8	26.5
103496	379.02-ES	G 3/8	10	50.0	22.8	26.5
103497	379.03-ES	G 1/2	15	58.0	22.8	28.3



379.01-ES



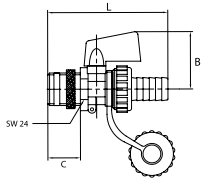

KFE-Ball valves



Boiler, filling and drain valves for heating systems.



KFE-12



KFE-12N

Rotating handle	Zinc Die Cast
Ball seal	PTFE
Cutting ring seal	PTFE
Stem seal	EPDM
For hose	I.D. 13 mm
Operating temperature	0 to 110 °C
Max. operating pressure	10 bar

KFE-Ball valve

Art. No.	Type No.	Thread	Housing	Ball	B mm	C mm	L mm
103414	KFE-12	G 1/2	Brass	Brass	37.0	20.0	74.6
103415	KFE-12N	G 1/2	Nickel-plated brass	Nickel-plated brass	37.0	20.0	74.6

Bibcocks

Nickel-plated brass



With hose connector.

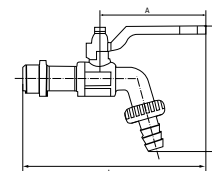

Material	Nickel-plated brass
Operating temperature	-20 to 80 °C
Sealant	NBR
Applications	Water, gaseous and non-corrosive media, compressed air
Thread material	Nickel-plated brass
Standard thread	G thread acc. to ISO 228-1

Bibcock nickel-plated brass

Art. No.	Type No.	Connection	DN	PN bar	For hose mm	L mm	A mm	H mm
103416	KAH.38	G 3/8 ET	10	15	I.D. 13	135.0	80.0	93.0
103417	KAH.12	G 1/2 ET	15	15	I.D. 13	137.0	80.0	93.0
103418	KAH.34	G 3/4 ET	20	15	I.D. 19	148.5	88.5	109.0
103419	KAH.10	G 1 ET	25	12	I.D. 25	158.0	88.5	126.0

→ The recommendation of the hose width I.D. refers to soft hoses



KAH.12



Bibcocks

Stainless steel

With hose connector, with lockable hand lever.

Material	Stainless steel 1.4408
Operating temperature	-10 to 150 °C
Sealant	NBR
Applications	Water, gaseous and non-corrosive media, compressed air
Thread material	Stainless steel 1.4408
Standard thread	G thread acc. to ISO 228-1

Bibcock stainless steel 1.4408

Art. No.	Type No.	Connection	DN	PN bar	For hose mm	L mm	A mm	H mm
103420	KAH.12-ES	G 1/2 ET	15	16	I.D. 13	149.0	90.0	91.0
103421	KAH.34-ES	G 3/4 ET	20	16	I.D. 19	156.0	90.0	102.0
103422	KAH.10-ES	G 1 ET	25	16	I.D. 25	145.0	90.0	116.0

→ The recommendation of the hose width I.D. refers to soft hoses



KAH.34-ES

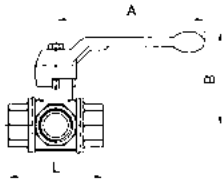

3-way ball valves

standard type, T-bore

EASY

Sealing on all sides with T-bore.

The lever of this model can only be turned 90° rather than 360°. Only two valve positions are therefore possible instead of four.

Housing	Nickel-plated brass
Ball	Nickel-plated brass
Spring	Stainless steel
Sealant	PTFE
Hand lever	Aluminium, painted black
Medium temperature	-15 to 100 °C
Ambient temperature	-15 to 100 °C
Thread material	Nickel-plated brass
Standard thread	Rp thread acc. to ISO 7-1



1084 CL

3-way ball valve, standard type, T-bore

Art. No.	Type No.	Thread	DN	L mm	A mm	B mm	Bore inball	Max. operating pressure at 20 °C bar
103369	1084 CL	Rp 1/2	15	80.0	130.0	85.0	13	40
103370	1084 DL	Rp 3/4	20	96.0	160.0	98.0	18	40
103371	1084 EL	Rp 1	25	113.0	160.0	102.0	23	25
103372	1084 FL	Rp 1 1/4	32	130.0	195.0	121.0	29	16
103373	1084 GL	Rp 1 1/2	40	147.0	195.0	125.0	35	16
103374	1084 HL	Rp 2	50	169.0	235.0	141.0	44	16

3-way ball valves

standard type, L-bore

EASY

3-way ball valves with full bore for diverting media.

Applications: Water, non-toxic gases, plumbing and heating systems, oils, general industrial applications, diesel fuel

Housing	Nickel-plated brass
Internal parts	Nickel-plated brass
Sealant	PTFE
Hand lever	Aluminium, painted black
Medium temperature	-10 to 120 °C
Ambient temperature	-10 to 120 °C
Thread material	Brass with a bare metal surface
Standard thread	Rp thread acc. to ISO 7-1



1081 E

3-way ball valve, standard type, L-bore

Art. No.	Type No.	Thread	DN	PN bar	L mm	A mm	B mm
103375	1081 A	Rp 1/4	8	40	52.0	100.0	61.0
103376	1081 B	Rp 3/8	10	40	55.0	100.0	61.0
103377	1081 C	Rp 1/2	15	40	69.0	100.0	64.0
103378	1081 D	Rp 3/4	20	40	77.0	120.0	76.0
103379	1081 E	Rp 1	25	40	89.0	120.0	80.0
103380	1081 F	Rp 1 1/4	32	10	103.0	150.0	98.0
103381	1081 G	Rp 1 1/2	40	10	114.0	150.0	104.0
103382	1081 H	Rp 2	50	10	134.0	175.0	119.0

3-way ball valves

sealing on all sides, L or T-bore

PLUS

The medium can enter via any of the ports to allow several switching variants.

3-way ball valves for diverting media.

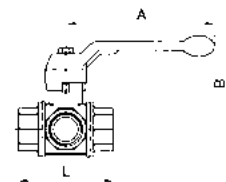

Housing	Nickel-plated brass
Ball	Bright brass
Spring	Stainless steel
Position indicator	Galvanised steel
Sealant	PTFE / FKM
Hand lever	Aluminium, painted black
Medium temperature	-15 to 100 °C
Ambient temperature	-15 to 100 °C
Thread material	Bright brass
Standard thread	Rp thread acc. to ISO 7-1

3-way ball valve, sealing on all sides, L-bore

Art. No.	Type No.	Thread	DN	L mm	A mm	B mm	Bore inball	Max. operating pressure at 20 °C bar
103383	1083 A	Rp 1/4	8	71.0	130.0	85.0	10	40
103384	1083 B	Rp 3/8	10	71.0	130.0	85.0	13	40
103385	1083 C	Rp 1/2	15	80.0	130.0	85.0	13	40
103386	1083 D	Rp 3/4	20	96.0	160.0	98.0	18	40
103387	1083 E	Rp 1	25	113.0	160.0	102.0	23	25
103388	1083 F	Rp 1 1/4	32	130.0	195.0	121.0	29	16
103389	1083 G	Rp 1 1/2	40	147.0	195.0	125.0	35	16
103390	1083 H	Rp 2	50	169.0	235.0	141.0	44	16



3-way ball valve, sealing on all sides, T-bore

Art. No.	Type No.	Thread	DN	L mm	A mm	B mm	Bore inball	Max. operating pressure at 20 °C bar
103391	1084 A	Rp 1/4	8	71.0	130.0	85.0	10	40
103392	1084 B	Rp 3/8	10	71.0	130.0	85.0	13	40
103393	1084 C	Rp 1/2	15	80.0	130.0	85.0	13	40
103394	1084 D	Rp 3/4	20	96.0	160.0	98.0	18	40
103395	1084 E	Rp 1	25	113.0	160.0	102.0	23	25
103396	1084 F	Rp 1 1/4	32	130.0	195.0	121.0	29	16
103397	1084 G	Rp 1 1/2	40	147.0	195.0	125.0	35	16
103398	1084 H	Rp 2	50	169.0	235.0	141.0	44	16

By reacting the lever stop by simply lifting the lever can be reached 4 x 90° rotation angle.

Thereby the following switch positions are possible.

L-Bore

T-Bore

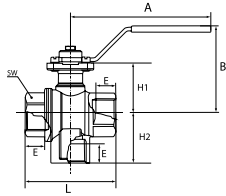

3-way ball valves

Lower media connection

PLUS

3-way ball valve with full throughput, integrated ISO flange plate (ISO 5211) and double-sided sealed ball. Pressurisation is only possible via the lower connection.

Housing	Nickel-plated brass (CW617N)
Thread material	Brass
Ball	Nickel-plated brass (CW617N)
Ball seal	PTFE
Stem seal	PTFE / FKM
Hand lever	Steel with plastic coating
Operating temperature	-15 to 120 °C
Standard thread	Rp thread acc. to ISO 7-1



1085 C

3-way ball valve, lower media connection, L-bore

Art. No.	Type No.	Thread	DN	PN bar	L mm	A mm	B mm	E mm	H1 mm	H2 mm	a/f mm
136326	1085 A	Rp 1/4	8	25	52.0	115.0	60.0	11.0	28.5	26.0	22
136327	1085 B	Rp 3/8	10	25	52.0	115.0	60.0	11.4	28.5	26.0	22
136328	1085 C	Rp 1/2	15	25	64.0	115.0	62.0	15.0	31.0	33.5	27
136329	1085 D	Rp 3/4	20	16	74.0	115.0	43.0	16.3	42.0	39.5	32
136330	1085 E	Rp 1	25	16	89.0	115.0	76.0	19.1	45.0	47.0	41
136331	1085 F	Rp 1 1/4	32	10	100.0	115.0	79.5	21.4	49.0	54.5	50
136332	1085 G	Rp 1 1/2	40	10	110.0	170.0	95.0	21.4	61.5	61.5	55
136333	1085 H	Rp 2	50	10	130.0	170.0	101.0	25.7	67.0	73.0	70

3-way ball valve, lower media connection, T-bore

Art. No.	Type No.	Thread	DN	PN bar	L mm	A mm	B mm	E mm	H1 mm	H2 mm	a/f mm
136334	1086 A	Rp 1/4	8	25	52.0	115.0	60.0	11.0	28.5	26.0	22
136335	1086 B	Rp 3/8	10	25	52.0	115.0	60.0	11.4	28.5	26.0	22
136336	1086 C	Rp 1/2	15	25	64.0	115.0	62.0	15.0	31.0	33.5	27
136337	1086 D	Rp 3/4	20	16	74.0	115.0	43.0	16.3	42.0	39.5	32
136338	1086 E	Rp 1	25	16	89.0	115.0	76.0	19.1	45.0	47.0	41
136339	1086 F	Rp 1 1/4	32	10	100.0	115.0	79.5	21.4	49.0	54.5	50
136340	1086 G	Rp 1 1/2	40	10	110.0	170.0	95.0	21.4	61.5	61.5	55
136341	1086 H	Rp 2	50	10	130.0	170.0	101.0	25.7	67.0	73.0	70

3-way ball valves

stainless steel, lockable

With L or T-bore, reduced bore.

Version for sealing on all sides with integrated ISO flange plate (ISO 5211).

The lever can be turned 360° to allow several switching variants.

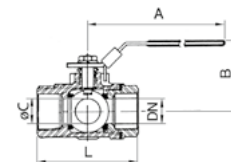

Housing	Stainless steel 1.4408
Ball	Stainless steel 1.4401
Ball seal	RTFE (15 % glass fibre reinforced PTFE)
Stem seal	RTFE (15 % glass fibre reinforced PTFE)
Hand lever	Stainless steel 1.4301, with plastic coating
Operating pressure	63 bar (dependent on temperature)
Operating temperature	-20 to 180 °C
Standard thread	G thread acc. to DIN EN ISO 228-1
Bore diameter padlock	ca. 7.9

3-way ball valve, L-bore

Art. No.	Type No.	Thread	DN	L mm	A mm	B mm	C Ø mm	ISO 5211
135920	11081 A-ES	G 1/4	8	75.7	112.0	77.5	11.0	F 04
135921	11081 B-ES	G 3/8	10	75.7	112.0	77.5	11.0	F 04
135922	11081 C-ES	G 1/2	15	75.7	112.0	77.5	12.7	F 04
135923	11081 D-ES	G 3/4	20	86.6	112.0	82.0	16.0	F 04
135924	11081 E-ES	G 1	25	102.4	136.5	93.7	20.0	F 05
135925	11081 F-ES	G 1 1/4	32	118.2	188.0	101.1	25.0	F 05
135926	11081 G-ES	G 1 1/2	40	125.8	197.5	120.3	32.0	F 07
135927	11081 H-ES	G 2	50	149.0	197.5	129.9	38.1	F 07



11081 D-ES



3-way ball valve, T-bore

Art. No.	Type No.	Thread	DN	L mm	A mm	B mm	C Ø mm	ISO 5211
135928	11082 A-ES	G 1/4	8	75.7	112.0	77.5	11.0	F 04
135929	11082 B-ES	G 3/8	10	75.7	112.0	77.5	11.0	F 04
135930	11082 C-ES	G 1/2	15	75.7	112.0	77.5	12.7	F 04
135931	11082 D-ES	G 3/4	20	86.6	112.0	82.0	16.0	F 04
135932	11082 E-ES	G 1	25	102.4	136.5	93.7	20.0	F 05
135933	11082 F-ES	G 1 1/4	32	118.2	188.0	101.1	25.0	F 05
135934	11082 G-ES	G 1 1/2	40	125.8	197.5	120.3	32.0	F 07
135935	11082 H-ES	G 2	50	149.0	197.5	129.9	38.1	F 07

→ The price does not include a padlock. Please order separately. See page 292



Ball valves

suitable for high pressure, steel



For liquid and lubricating media.

Available versions:

- For solderless tube fittings acc. to DIN 2353, lightweight series acc. to ISO 8434-1.
- For solderless tube fittings acc. to DIN 2353, heavy-duty series acc. to ISO 8434-1.
- With female pipe thread acc. to DIN ISO 228-1 (BSP).

Housing	Steel
Selector shaft	Steel
Ball	Hard-chrome plated steel
Control ball seal	POM
Selector shaft seal	NBR
Bore inball	Full bore
Operating temperature	-10 to 100 °C



392.04

High-pressure ball valve, steel, lightweight series

Art. No.	Type No.	Thread	Max. operating pressure bar	DN	For tube O.D. mm	L mm	A mm	B mm
103498	392.01	M12x1.5	500	4	6L	67.0	76.0	55.0
103499	392.02	M14x1.5	500	6	8L	67.0	76.0	55.0
103500	392.03	M16x1.5	500	8	10L	75.0	100.0	68.0
103501	392.04	M18x1.5	500	10	12L	75.0	100.0	68.0
103502	392.05	M22x1.5	500	12	15L	83.0	112.0	92.0
103503	392.06	M26x1.5	420	16	18L	82.0	166.0	105.0
103504	392.07	M30x2	420	20	22L	99.0	187.0	121.0
103505	392.08	M36x2	420	25	28L	108.0	187.0	128.0

High-pressure ball valve, steel, heavy-duty series

Art. No.	Type No.	Thread	Max. operating pressure bar	DN	For tube O.D. mm	L mm	A mm	B mm
103506	392.11	M16x1.5	500	4	8S	73.0	76.0	55.0
103507	392.12	M18x1.5	500	6	10S	73.0	76.0	55.0
103508	392.13	M20x1.5	500	8	12S	77.0	100.0	68.0
103509	392.14	M22x1.5	500	10	14S	81.0	100.0	68.0
103510	392.15	M24x1.5	500	12	16S	87.0	112.0	92.0
103511	392.16	M30x2	420	16	20S	90.0	166.0	105.0
103512	392.17	M36x2	420	20	25S	107.0	187.0	121.0
103513	392.18	M42x2	420	25	30S	120.0	187.0	128.0



392.27

High-pressure ball valve, steel, with G female thread

Art. No.	Type No.	Thread	Max. operating pressure bar	DN	L mm	A mm	B mm
103514	392.21	G 1/8	500	4	69.0	76.0	55.0
103515	392.22	G 1/4	500	6	69.0	76.0	55.0
103516	392.23	G 3/8	500	10	73.0	100.0	68.0
103517	392.24	G 1/2	500	12	82.0	112.0	92.0
103518	392.25	G 5/8	420	16	88.0	166.0	105.0
103519	392.26	G 3/4	420	20	93.0	187.0	121.0
103520	392.27	G 1	420	25	115.0	187.0	128.0

Brass ball valves

with pneumatic actuator - basic version

PLUS

Ball valves with pneumatic actuator.

Pneumatic, double-piston, part-turn actuator, double-rocker principle.

Material actuator	Anodised aluminium
Sealant actuator	NBR
Angle of rotation	90 °
Operating temperature actuator	-20 to 80 °C
Max. pilot pressure actuator	8.4 bar
Recommended pilot pressure	5.6 bar
Material ball valve	Nickel-plated brass, with flange plate ISO 5211
Sealant ball valve	PTFE / FKM
Operating temperature ball valve	-20 to 150 °C
Max. operating pressure ball valve	16 bar

Brass ball valve, double-acting actuator

Art. No.	Type No.	Thread	DN	Valve adapter	L mm	A mm	B mm
158828	351.209-1	Rp 3/8	10	Valve adapter NAMUR sold separately 118367	69.0	70.0	85.0
158829	351.210-1	Rp 1/2	15	Valve adapter NAMUR sold separately 118367	69.0	70.0	88.0
158830	351.211-1	Rp 3/4	20	Valve adapter NAMUR sold separately 118367	77.0	70.0	94.0
158831	351.212-1	Rp 1	25	Valve adapter NAMUR sold separately 118367	89.0	70.0	98.0
158800	351.213-1	Rp 1 1/4	32	Integrated to NAMUR	103.0	159.0	122.8
158801	351.214-1	Rp 1 1/2	40	Integrated to NAMUR	114.0	159.0	129.8
158802	351.215-1	Rp 2	50	Integrated to NAMUR	134.0	174.2	143.8

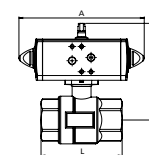

351.213-1

Brass ball valve, single-acting actuator - spring to close

Art. No.	Type No.	Thread	DN	Valve adapter	L mm	A mm	B mm
158746	351.309-1	Rp 3/8	10	Integrated to NAMUR	69.0	233.2	105.8
158747	351.310-1	Rp 1/2	15	Integrated to NAMUR	69.0	233.2	108.8
158748	351.311-1	Rp 3/4	20	Integrated to NAMUR	77.0	233.2	115.8
158749	351.312-1	Rp 1	25	Integrated to NAMUR	89.0	233.2	119.8
158750	351.313-1	Rp 1 1/4	32	Integrated to NAMUR	103.0	233.2	129.8
158751	351.314-1	Rp 1 1/2	40	Integrated to NAMUR	114.0	233.2	136.8
158752	351.315-1	Rp 2	50	Integrated to NAMUR	134.0	258.8	155.0

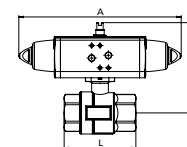

351.313-1

→ For NAMUR pilot valves look at page 429-431

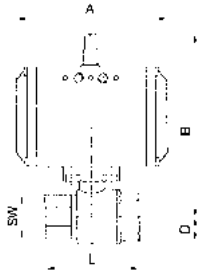

Brass ball valves

with pneumatic actuator

MAX

2-way cock, full bore.

Pneumatic actuators, double- or single acting version and integrated end-position feedback.

Material actuator	Anodised aluminium
Sealant actuator	NBR
Angle of rotation	90 °
Max. pilot pressure actuator	10 bar
Recommended pilot pressure	5.5 bar
Valve adapter	Supplied as standard
Material ball valve	Nickel-plated brass, with ISO flange plate
Sealant ball valve	PTFE / FKM
Operating temperature	-20 to 70 °C



350.212/1

Brass ball valve, double-acting actuator

Art. No.	Type No.	Thread	DN	PN bar	a/f mm	L mm	A mm	B mm	D mm
103521	350.210	Rp 1/2	15	40	26	75.0	133.0	142.0	17.0
103522	350.210/1	Rp 1/2	15	40	26	75.0	116.0	133.0	17.0
103523	350.211	Rp 3/4	20	40	32	80.0	133.0	145.0	20.0
103524	350.211/1	Rp 3/4	20	40	32	80.0	116.0	136.0	20.0
103525	350.212	Rp 1	25	40	41	90.0	133.0	148.0	25.0
103526	350.212/1	Rp 1	25	40	41	90.0	116.0	139.0	25.0
103527	350.213	Rp 1 1/4	32	40	50	110.0	116.0	150.0	30.0
103528	350.214	Rp 1 1/2	40	25	55	120.0	133.0	166.0	36.0
103529	350.215	Rp 2	50	25	70	140.0	137.0	191.0	45.0
103530	350.216	Rp 2 1/2	65	25	83	155.0	161.0	213.0	57.0
103531	350.217	Rp 3	80	16	98	182.0	161.0	225.0	68.0

Brass ball valve, single-acting actuator - spring to close

Art. No.	Type No.	Thread	DN	PN bar	a/f mm	L mm	A mm	B mm	D mm
103532	350.310	Rp 1/2	15	40	26	75.0	133.0	142.0	17.0
103533	350.311	Rp 3/4	20	40	32	80.0	133.0	145.0	20.0
103534	350.312	Rp 1	25	40	41	90.0	133.0	148.0	25.0
103535	350.313	Rp 1 1/4	32	40	50	110.0	137.0	173.0	30.0
103536	350.314	Rp 1 1/2	40	25	55	120.0	137.0	180.0	36.0
103537	350.315	Rp 2	50	25	70	140.0	180.0	203.0	45.0
103538	350.316	Rp 2 1/2	65	25	83	155.0	209.0	230.0	57.0
103539	350.317	Rp 3	80	16	98	182.0	209.0	242.0	68.0

Brass ball valve, single-acting actuator - spring to open

Art. No.	Type No.	Thread	DN	PN bar	a/f mm	L mm	A mm	B mm	D mm
103540	350.410	Rp 1/2	15	40	26	75.0	133.0	142.0	17.0
103541	350.410/1	Rp 1/2	15	40	26	75.0	116.0	133.0	17.0
103542	350.411	Rp 3/4	20	40	32	80.0	133.0	145.0	20.0
103543	350.412	Rp 1	25	40	41	90.0	133.0	148.0	25.0
103544	350.413	Rp 1 1/4	32	40	50	110.0	137.0	173.0	30.0
103545	350.414	Rp 1 1/2	40	25	55	120.0	137.0	180.0	36.0
103546	350.415	Rp 2	50	25	70	140.0	180.0	203.0	45.0
103547	350.416	Rp 2 1/2	65	25	83	155.0	209.0	230.0	57.0
103548	350.417	Rp 3	80	16	98	182.0	209.0	242.0	68.0

→ For NAMUR pilot valves look at page 429-431

Brass ball valves

with pneumatic actuator

MAX

3-way cock, L-bore or T-bore, full bore.

Pneumatic actuators, double- or single acting version and integrated end-position feedback.

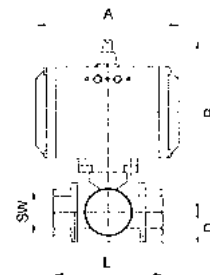

Material actuator	Anodised aluminium
Sealant actuator	NBR
Angle of rotation	90 °
Max. pilot pressure actuator	10 bar
Recommended pilot pressure	5.5 bar
Valve adapter	Supplied as standard
Material ball valve	Nickel-plated brass, with ISO flange plate
Sealant ball valve	PTFE / FKM
Operating temperature	-20 to 70 °C

Brass ball valve, 3-way, with double-acting actuator, L-bore

Art. No.	Type No.	Thread	Position	DN	PN bar	a/f mm	L mm	A mm	B mm	D mm
103549	350.610/1	Rp 1/2	L 2	15	40	25	64.5	116.0	133.0	20.0
103550	350.611	Rp 3/4	L 2	20	40	31	76.0	116.0	137.0	24.0
103551	350.612	Rp 1	L 2	25	40	41	97.0	116.0	141.5	30.0
103552	350.613	Rp 1 1/4	L 2	32	40	55	118.0	133.0	165.5	37.0
103553	350.614	Rp 1 1/2	L 2	40	25	55	135.0	137.0	181.5	43.0
103554	350.615	Rp 2	L 2	50	25	67	157.0	161.0	204.0	56.0

Brass ball valve, 3-way, with single-acting actuator, L-bore

Art. No.	Type No.	Thread	Position	DN	PN bar	a/f mm	L mm	A mm	B mm	D mm
103555	350.710	Rp 1/2	L 2	15	40	25	64.5	133.0	142.0	20.0
103556	350.712	Rp 1	L 2	25	40	41	97.0	133.0	150.5	30.0
103557	350.714	Rp 1 1/2	L 2	40	25	55	135.0	180.0	193.5	43.0

Brass ball valve, 3-way, with double-acting actuator, T-bore, normal position T3

Art. No.	Type No.	Thread	Position	DN	PN bar	a/f mm	L mm	A mm	B mm	D mm
159744	KHRP12MSANTDT3	Rp 1/2	T 3	15	40	25	64.5	133.0	142.0	20.0
103559	350.723-T3	Rp 3/4	T 3	20	40	31	76.0	133.0	146.0	24.0
159745	KHRP1MSANTDT3	Rp 1	T 3	25	40	41	97.0	133.0	150.5	30.0
103561	350.725-T3	Rp 1 1/4	T 3	32	40	55	118.0	161.0	191.5	37.0
103562	350.726-T3	Rp 1 1/2	T 3	40	25	55	133.0	180.0	193.5	43.0
103563	350.727-T3	Rp 2	T 3	50	25	67	157.0	209.0	221.0	56.0



350.725-T3

→ Other positions on request

→ For NAMUR pilot valves look at page 429-431

Variants	Position		
	Normal position 0°	Rotating direction	Valve position 90°
L2			
T1			
T2			
T3			

Stainless steel ball valves

with pneumatic actuator - basic version

Ball valves with pneumatic actuator. Pneumatic, double-piston, part-turn actuator, double-rocker principle.

Material actuator	Anodised aluminium
Sealant actuator	NBR
Angle of rotation	90 °
Operating temperature actuator	-20 to 80 °C
Max. pilot pressure actuator	8.4 bar
Recommended pilot pressure	5.6 bar
Valve adapter	Integrated to NAMUR
Material ball valve	Stainless steel 1.4401/1.4301/1.4310/1.4408, with ISO flange
Sealant ball valve	PTFE / FKM
Operating temperature ball valve	-20 to 150 °C

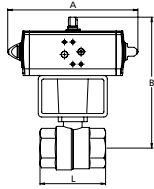

351.513-1

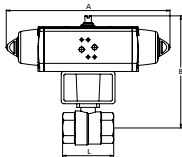

351.523-1

Stainless steel ball valve, double-acting actuator, valve adapter integrated to NAMUR

Art. No.	Type No.	Thread	DN	PN bar	L mm	A mm	B mm
158753	351.509-2	Rp 3/8	10	100	55.0	159.0	144.2
158754	351.510-2	Rp 1/2	15	100	65.0	159.0	147.0
158755	351.511-1	Rp 3/4	20	100	70.0	174.2	160.5
158756	351.512-1	Rp 1	25	100	85.0	174.2	160.5
158757	351.513-1	Rp 1 1/4	32	64	95.0	188.5	188.5
158758	351.514-1	Rp 1 1/2	40	64	105.0	198.0	200.7
158759	351.515-1	Rp 2	50	40	125.0	237.0	221.2

Stainless steel ball valve, single-acting actuator, spring to close, valve adapter integrated to NAMUR

Art. No.	Type No.	Thread	DN	PN bar	L mm	A mm	B mm
158760	351.519-2	Rp 3/8	10	100	55.0	233.2	151.2
158761	351.520-2	Rp 1/2	15	100	65.0	233.2	154.0
158762	351.521-1	Rp 3/4	20	100	70.0	258.8	181.7
158763	351.522-1	Rp 1	25	100	85.0	258.8	185.7
158764	351.523-1	Rp 1 1/4	32	64	95.0	304.2	207.3
158765	351.524-1	Rp 1 1/2	40	64	105.0	338.5	217.3
158766	351.525-1	Rp 2	50	40	125.0	393.7	255.4

Stainless steel ball valves

with pneumatic actuator

2-way cock, 3-piece, full bore.

Pneumatic actuators, double- or single acting version and integrated end-position feedback.

Standardised interfaces:

Actuator/valve interface: Four or eight female threads in the actuator housing acc. to EN ISO 5211.

Actuator/control valve interface: Acc. to NAMUR or VDI/VDE 3845.

Actuator/signalling device interface: Acc. to VDI/VDE 3845 (NAMUR).

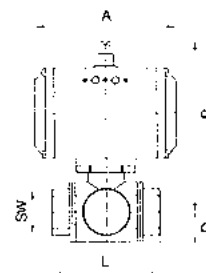

Material actuator	Anodised aluminium
Sealant actuator	NBR
Angle of rotation	90 °
Max. pilot pressure actuator	10 bar
Recommended pilot pressure	5.5 bar
Valve adapter	Acc. to NAMUR
Material ball valve	Stainless steel 1.4401, with ISO flange plate
Sealant ball valve	PTFE
Operating temperature	-20 to 70 °C
Max. operating pressure	63 bar

Stainless steel ball valve, double-acting actuator

Art. No.	Type No.	Thread	DN	a/f mm	L mm	A mm	B mm	D mm
103595	350.510	Rp 1/2	15	29	75.0	133.0	144.0	24.0
103596	350.510/1	Rp 1/2	15	29	75.0	116.0	135.0	24.0
103597	350.511	Rp 3/4	20	35	80.0	133.0	148.0	27.0
103598	350.511/1	Rp 3/4	20	35	80.0	116.0	139.0	27.0
103599	350.512	Rp 1	25	41	90.0	133.0	157.0	30.0
103600	350.513	Rp 1 1/4	32	50	110.0	137.0	176.0	37.0
103601	350.514	Rp 1 1/2	40	58	120.0	137.0	186.0	40.0
103602	350.515	Rp 2	50	74	140.0	161.0	207.0	50.0
103603	350.516	Rp 2 1/2	65	89	185.0	180.0	238.0	60.0
103604	350.517	Rp 3	80	104	205.0	209.0	257.0	82.0

Stainless steel ball valve, single-acting actuator - spring to close

Art. No.	Type No.	Thread	DN	a/f mm	L mm	A mm	B mm	D mm
103605	350.520	Rp 1/2	15	29	75.0	133.0	144.0	24.0
103606	350.520/1	Rp 1/2	15	29	75.0	116.0	135.0	24.0
103607	350.521	Rp 3/4	20	35	80.0	133.0	148.0	27.0
103608	350.522	Rp 1	25	41	90.0	137.0	170.0	33.0
103609	350.523	Rp 1 1/4	32	50	110.0	161.0	188.0	37.0
103610	350.524	Rp 1 1/2	40	58	120.0	180.0	198.0	40.0
103611	350.525	Rp 2	50	74	140.0	209.0	224.0	50.0
103612	350.526	Rp 2 1/2	65	85	185.0	221.0	268.0	60.0
103613	350.527	Rp 3	80	100	205.0	221.0	280.0	67.0



350.523



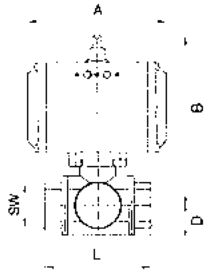

Stainless steel ball valves

with pneumatic actuator

3-way cock, reduced bore.

Pneumatic actuators, double- or single acting version and integrated end-position feedback.

Standardised interfaces:

Actuator/valve interface: Four or eight female threads in the actuator housing acc. to EN ISO 5211.

Actuator/control valve interface: Acc. to NAMUR or VDI/VDE 3845.

Actuator/signalling device interface: Acc. to VDI/VDE 3845 (NAMUR).

Material actuator	Anodised aluminium
Sealant actuator	NBR
Angle of rotation	90 °
Max. pilot pressure actuator	10 bar
Recommended pilot pressure	5.5 bar
Valve adapter	Acc. to NAMUR
Material ball valve	Stainless steel 1.4401, with ISO flange plate
Sealant ball valve	PTFE / FKM
Operating temperature	-20 to 70 °C
Max. operating pressure	63 bar



350.624-L1

Stainless steel ball valve, 3-way, with double-acting actuator, L-bore

Art. No.	Type No.	Thread	Position	DN	a/f mm	L mm	A mm	B mm	D mm
103614	350.622-L1	Rp 1/2	L 2	15	27	73.0	116.0	130.0	20.0
103615	350.623-L1	Rp 3/4	L 2	20	32	80.0	116.0	136.0	23.0
103616	350.624-L1	Rp 1	L 2	25	41	90.0	133.0	148.5	28.5
103617	350.625-L1	Rp 1 1/4	L 2	32	50	90.0	133.0	153.5	36.5
103618	350.626-L1	Rp 1 1/2	L 2	40	55	105.0	137.0	173.0	37.0
103619	350.627-L1	Rp 2	L 2	50	71	115.0	161.0	196.5	47.5

Stainless steel ball valve, 3-way, with single-acting actuator, L-bore

Art. No.	Type No.	Thread	Position	DN	a/f mm	L mm	A mm	B mm	D mm
103620	350.632-L1	Rp 1/2	L 2	15	27	73.0	133.0	139.0	20.0
103621	350.633-L1	Rp 3/4	L 2	20	32	80.0	137.0	159.0	23.0
103622	350.634-L1	Rp 1	L 2	25	41	90.0	161.0	174.5	28.5
103623	350.635-L1	Rp 1 1/4	L 2	32	50	90.0	161.0	179.5	36.5
103624	350.636-L1	Rp 1 1/2	L 2	40	55	105.0	180.0	185.0	37.0
103625	350.637-L1	Rp 2	L 2	50	71	115.0	209.0	213.5	47.5

Stainless steel ball valve, 3-way, with double-acting actuator, T-bore

Art. No.	Type No.	Thread	Position	DN	a/f mm	L mm	A mm	B mm	D mm
103626	350.912-T1	Rp 1/2	T 1	15	27	73.0	116.0	130.0	20.0
159746	KHRP34ESANTDT1	Rp 3/4	T 1	20		80.0	116.0	136.0	23.0
103628	350.914-T1	Rp 1	T 1	25	41	90.0	133.0	148.5	28.5
103629	350.915-T1	Rp 1 1/4	T 1	32	50	90.0	133.0	153.5	36.5
103630	350.916-T1	Rp 1 1/2	T 1	40	55	105.0	137.0	173.0	37.0
159747	KHRP2ESANTDT1	Rp 2	T 1	50	71	115.0	161.0	196.5	47.5

Stainless steel ball valve, 3-way, with double-acting actuator, T-bore

Art. No.	Type No.	Thread	Position	DN	a/f mm	L mm	A mm	B mm	D mm
159748	KHRP12ESANTDT2	Rp 1/2	T 2	15	27	73.0	116.0	130.0	20.0
103633	350.913-T2	Rp 3/4	T 2	20	32	80.0	116.0	136.0	23.0
103634	350.914-T2	Rp 1	T 2	25	41	90.0	133.0	148.5	28.5
103635	350.915-T2	Rp 1 1/4	T 2	32	50	90.0	133.0	153.5	36.5
103636	350.916-T2	Rp 1 1/2	T 2	40	55	105.0	137.0	173.0	37.0
103637	350.917-T2	Rp 2	T 2	50	71	115.0	161.0	196.5	47.5

→ Other positions on request

End position feedbacks

Robust and compact end position feedback with aluminium housing.

- Actuator hole spacings 80 x 30 mm or 130 x 30 mm
- Height-adjustable assembly bridge for actuator shaft heights 20/30/40/50 mm
- 3D position indicator also visible from a distance
- Easy-to-adjust, self-locking trip cam

End position feedback

Micro switch SPDT

Ambient temperature	-25 to 80 °C
Housing	Aluminium
Switching function	Mechanical (NO/NC), silver-plated contacts
Cable gland	M20x1.5
Protection IP	IP 66/67, acc. to DIN EN 60529
Version	with microswitch

End position feedback, aluminium, micro switch SPDT

Art. No.	Type No.	Voltage range	Nominal switching capacity	Description
117191	ELRAMS	12-250 V AC/DC	AC: 10A/250V, DC: 2.5A/24V	SPDT - microswitch double



ELRAMS

End position feedback

Inductive sensors PNP

Ambient temperature	-25 to 80 °C
Housing	Aluminium
Switching function	PNP (NO)
Cable gland	M20x1.5
Protection IP	IP 66/67, acc. to DIN EN 60529
Version	with inductive sensor

End position feedback, aluminium, inductive sensors PNP

Art. No.	Type No.	Voltage range	Nominal switching capacity	Description
117192	ELRAIS	10-30 V DC	0-200mA	IS5001 - inductive sensor quadruple



ELRAIS

End position feedback

Inductive NAMUR sensors

Ambient temperature	-25 to 70 °C
Housing	Aluminium
Switching function	Inductive (NAMUR NO/NC)
Cable gland	M20x1.5
Protection IP	IP 66/67, acc. to DIN EN 60529
Version	with inductive sensor ATEX type

End position feedback, aluminium, inductive NAMUR sensors

Art. No.	Type No.	Voltage range	Nominal switching capacity	Description
117198	ELRAISEx	8.2V DC	<= 1.0mA / >=2,1mA	NJ2 - inductive sensor quadruple



ELRAISEx



End position feedbacks

Robust and compact end position feedback with plastic housing.

- Actuator hole spacings 80 x 30 mm or 130 x 30 mm
- Height-adjustable assembly bridge for actuator shaft heights 20/30/40/50 mm
- 3D position indicator also visible from a distance
- Easy-to-adjust, self-locking trip cam

End position feedback

Micro switch SPDT



ELRPMS

Ambient temperature	-25 to 80 °C
Housing	PA6/PC
Switching function	Changeover (NO/NC), silver-plated contacts
Cable gland	M20x1.5
Protection IP	IP 67, acc. to DIN EN 60529
Version	with microswitch

End position feedback, PA6/PC, micro switch SPDT

Art. No.	Type No.	Voltage range	Nominal switching capacity	Description
117213	ELRPMS	12-250 V AC/DC	AC: 10A/250V, DC: 2.5A/24V	SPDT - microswitch double

End position feedback

Inductive sensors PNP



ELRPIS

Ambient temperature	-25 to 80 °C
Housing	PA6/PC
Switching function	PNP (NO)
Cable gland	M20x1.5
Protection IP	IP 66/67, acc. to DIN EN 60529
Version	with inductive sensor

End position feedback, PA6/PC, inductive sensors PNP

Art. No.	Type No.	Voltage range	Nominal switching capacity	Description
117247	ELRPIS	10-30 V DC	0-200mA	IS5001 - inductive sensor quadruple

End position feedback

Inductive NAMUR sensors



ELRVIEx

Ambient temperature	-25 to 70 °C
Housing	PA
Switching function	Inductive (NAMUR NO/NC)
Cable gland	M20x1.5
Protection IP	IP 67, acc. to DIN EN 60529
Version	with inductive sensor ATEX type

End position feedback, PA glass fiber reinforced, inductive NAMUR sensors

Art. No.	Type No.	Voltage range	Nominal switching capacity	Description
117259	ELRPIEx	8.2V DC	<= 1.0mA / >=2.1mA	NJ2 -inductive sensor quadruple

Brass ball valves

with electric actuator

PLUS

Voltage range 230 VAC, 50 Hz or 24 VDC.
2-way cock, full bore, for neutral gases and liquids.
Reversible electric rotary actuator.

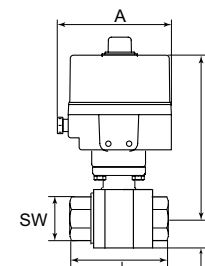

Housing	Aluminium powder-coated
Protection IP	IP 68
Ambient temperature	-30 to 70 °C
Relative humidity	30 % to 95 %
Position indicator	Manually operated
Duty cycle	30 %
Mounting flange	ISO 5211
Material	Nickel-plated brass
Ball	Hard chrome-plated brass
Selector shaft	Hard chrome-plated brass
Ball seal	PTFE, glass fibre-reinforced
Selector shaft seal	FKM
Operating temperature	-20 to 70 °C

Brass ball valve with electric actuator 230 VAC, 50 Hz, actuating time 15 sec.

Art. No.	Type No.	Thread	DN	PN bar	a/f mm	L mm	A mm	B mm	D mm
103694	350.1810R	Rp 1/2	15	40	26	75.0	153.0	164.5	17.0
103695	350.1811R	Rp 3/4	20	40	32	80.0	153.0	167.0	20.0
103696	350.1812R	Rp 1	25	40	41	90.0	153.0	170.5	25.0
103697	350.1813R	Rp 1 1/4	32	40	50	110.0	153.0	181.5	30.0
103698	350.1814R	Rp 1 1/2	40	25	55	120.0	153.0	188.0	36.0
103699	350.1815R	Rp 2	50	25	70	140.0	153.0	199.5	44.0



350.2812R



Brass ball valve with electric actuator 24 VDC, actuating time 20 sec.

Art. No.	Type No.	Thread	DN	PN bar	a/f mm	L mm	A mm	B mm	D mm
103700	350.2810R	Rp 1/2	15	40	26	75.0	153.0	164.5	17.0
103701	350.2811R	Rp 3/4	20	40	32	80.0	153.0	167.0	20.0
103702	350.2812R	Rp 1	25	40	41	90.0	153.0	170.5	25.0
103703	350.2813R	Rp 1 1/4	32	40	50	110.0	153.0	181.5	30.0
103704	350.2814R	Rp 1 1/2	40	25	55	120.0	153.0	188.0	36.0
103705	350.2815R	Rp 2	50	25	70	140.0	153.0	199.5	44.0



350.2815R

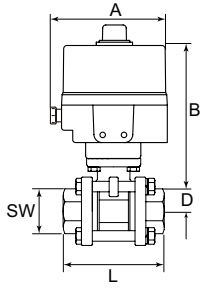

Stainless steel ball valves

with electric actuator

Voltage range 230 VAC, 50 Hz or 24 VDC.
Reversible electric rotary actuator.

Housing	Aluminium powder-coated
Protection IP	IP 68
Ambient temperature	-30 to 70 °C
Relative humidity	30 % to 95 %
Position indicator	Manually operated
Duty cycle	30 %
Mounting flange	ISO 5211
Length	DIN 3203 - M3
Material	Stainless steel 1.4401 / 1.4408
Ball seal	PTFE, glass fibre-reinforced
Selector shaft seal	PTFE, glass fibre-reinforced
Medium temperature	-10 to 200 °C
Max. operating pressure	63 bar



350.3810R

Stainless steel ball valve with electric actuator 230 VAC, 50 Hz

Art. No.	Type No.	Thread	DN	a/f mm	Actuating time sec.	L mm	A mm	B mm	D mm
103706	350.3810R	Rp 1/2	15	28	15	75.0	153.0	152.5	14.0
103707	350.3811R	Rp 3/4	20	35	15	80.0	153.0	153.0	17.5
103708	350.3812R	Rp 1	25	41	15	90.0	153.0	158.0	20.5
103709	350.3813R	Rp 1 1/4	32	50	15	110.0	153.0	159.5	25.0
103710	350.3814R	Rp 1 1/2	40	58	15	120.0	153.0	165.5	29.0
103711	350.3815R	Rp 2	50	73	22	140.0	153.0	201.0	36.5



350.4812R

Stainless steel ball valve with electric actuator 24 VDC

Art. No.	Type No.	Thread	DN	a/f mm	Actuating time sec.	L mm	A mm	B mm	D mm
103712	350.4810R	Rp 1/2	15	28	20	75.0	153.0	152.5	14.0
103713	350.4811R	Rp 3/4	20	35	20	80.0	153.0	153.0	17.5
103714	350.4812R	Rp 1	25	41	20	90.0	153.0	158.0	20.5
103715	350.4813R	Rp 1 1/4	32	50	20	110.0	153.0	159.5	25.0
103716	350.4814R	Rp 1 1/2	40	58	20	120.0	153.0	165.5	29.0
103717	350.4815R	Rp 2	50	73	30	140.0	153.0	201.0	36.5

Butterfly valves

with pneumatic actuator



Butterfly valves with pneumatic actuator. Pneumatic actuators, double- or single acting version. For water/steam, seawater, salt water, ester, ketones, alkalis, caustic soda, sodium hydroxide. Not recommended for hydrocarbons, oils or greases.

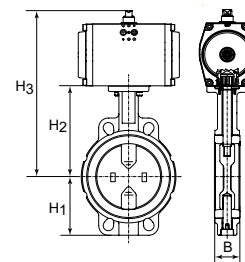

Material actuator	Anodised aluminium
Sealant actuator	NBR
Angle of rotation	90 °
Min. pilot pressure	5 bar
Max. pilot pressure	5.5 bar
Valve adapter	Supplied as standard, operated by a 3/2- or 5/2-way valve
Housing	Grey cast iron GG25 epoxy resin coated, RAL 5015 color
Disc	Stainless steel CF8M/1.4404
Sealant	EPDM
Selector shaft	SS416
Selector shaft seal	EPDM
Max. operating pressure	16 bar
Operating temperature	-15 to 120 °C

Butterfly valve, with double-acting actuator

Art. No.	Type No.	DN	H1 mm	H2 mm	H3 mm	L mm	B mm
103667	350.4040B	40	68.0	108.0	212.0	94.0	38.0
103668	350.4050B	50	71.0	143.0	247.0	100.0	47.0
103669	350.4065B	65	78.0	155.0	259.0	115.0	49.0
103670	350.4080B	80	89.0	162.0	280.0	127.0	47.0
103671	350.4100B	100	102.0	178.0	308.0	163.0	56.0
103672	350.4125B	125	123.0	191.0	321.0	190.0	59.0
103673	350.4150B	150	138.0	205.0	352.0	216.0	59.0



350.4065B



Butterfly valve, with single-acting actuator - spring to close

Art. No.	Type No.	DN	H1 mm	H2 mm	H3 mm	L mm	B mm
103674	350.5040B	40	68.0	108.0	238.0	94.0	38.0
103675	350.5050B	50	71.0	143.0	273.0	100.0	47.0
103676	350.5065B	65	78.0	155.0	285.0	115.0	49.0
103677	350.5080B	80	89.0	162.0	292.0	127.0	47.0
103678	350.5100B	100	102.0	178.0	348.0	163.0	56.0
103679	350.5125B	125	123.0	191.0	361.0	190.0	59.0
103680	350.5150B	150	138.0	265.0	395.0	216.0	59.0



350.4150B

3

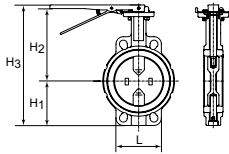

Butterfly valves

with hand lever



Butterfly valves with hand lever suitable for water/steam, seawater, salt water, ester, ketones, alkalis, caustic soda, sodium hydroxide.
Not recommended for hydrocarbons, oils or greases.

Housing	Grey cast iron GG25 epoxy resin coated, color RAL 5015
Disc	Stainless steel CF8M/1.4404
Sealant	EPDM
Selector shaft	SS416
Selector shaft seal	EPDM
Hand lever	GG25 epoxy resin coated
Max. operating pressure	16 bar
Operating temperature	-15 to 120 °C



350.6065B

Butterfly valve

Art. No.	Type No.	DN	H1 mm	H2 mm	H3 mm	L mm	B mm
103681	350.6040B	40	68.0	94.0	198.0	94.0	38.0
103682	350.6050B	50	71.0	143.0	236.0	100.0	47.0
103683	350.6065B	65	78.0	155.0	255.0	115.0	49.0
103684	350.6080B	80	89.0	162.0	273.0	127.0	47.0
103685	350.6100B	100	102.0	178.0	302.0	163.0	56.0
103686	350.6125B	125	123.0	191.0	336.0	190.0	59.0
103687	350.6150B	150	138.0	205.0	365.0	216.0	59.0

Coaxial valves

pneumatically operated

EASY

2/2-way coaxial valves, specially designed for automated industrial plant engineering. A low-price, compact, space-saving and reliable alternative to ball valves with a pneumatic rotary actuator. These valves have a full bore and – owing to the optimised design – only minimal flow losses. They are controlled by means of filtered compressed air.

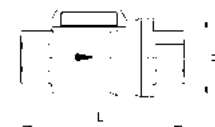

Housing	Nickel-plated brass
Internal parts	Nickel-plated brass
Spring	Stainless steel
Connection	NAMUR interface, direct: 2 x G 1/8
Max. operating pressure	10 bar
Mounting position	Any

Coaxial valve, double-acting, NBR

Art. No.	Type No.	Thread	Sealant	Pilot pressure bar	Operating temperature °C	DN	H mm	L mm
103723	351.911	Rp 3/8	NBR	3 - 8	-20 to 80	10	46.0	98.0
103724	351.912	Rp 1/2	NBR	3 - 8	-20 to 80	15	51.7	112.0
103725	351.913	Rp 3/4	NBR	3 - 8	-20 to 80	20	63.5	135.0
103726	351.914	Rp 1	NBR	3 - 8	-20 to 80	25	69.0	143.0
133388	351.915	Rp 1 1/4	NBR	3 - 8	-20 to 80	32	86.0	165.0
133389	351.916	Rp 1 1/2	NBR	3 - 8	-20 to 80	40	96.0	180.0
133390	351.917	Rp 2	NBR	3 - 8	-20 to 80	50	109.0	207.0



351.912

Coaxial valve, double-acting, FKM

Art. No.	Type No.	Thread	Sealant	Pilot pressure bar	Operating temperature °C	DN	H mm	L mm
103727	351.921	Rp 3/8	FKM	3 - 8	-20 to 150	10	46.0	98.0
103728	351.922	Rp 1/2	FKM	3 - 8	-20 to 150	15	51.7	112.0
103729	351.923	Rp 3/4	FKM	3 - 8	-20 to 150	20	63.5	135.0
103730	351.924	Rp 1	FKM	3 - 8	-20 to 150	25	69.0	143.0
133391	351.925	Rp 1 1/4	FKM	3 - 8	-20 to 150	32	86.0	165.0
133392	351.926	Rp 1 1/2	FKM	3 - 8	-20 to 150	40	96.0	180.0
133393	351.927	Rp 2	FKM	3 - 8	-20 to 150	50	109.0	207.0

Coaxial valve, single-acting - spring to open, NBR

Art. No.	Type No.	Thread	Sealant	Pilot pressure bar	Operating temperature °C	DN	H mm	L mm
103731	351.941	Rp 3/8	NBR	4.2 - 8	-20 to 80	10	46.0	98.0
103732	351.942	Rp 1/2	NBR	4.2 - 8	-20 to 80	15	51.7	112.0
103733	351.943	Rp 3/4	NBR	4.2 - 8	-20 to 80	20	63.5	135.0
103734	351.944	Rp 1	NBR	4.2 - 8	-20 to 80	25	69.0	143.0
133394	351.945	Rp 1 1/4	NBR	4.2 - 8	-20 to 80	32	86.0	165.0
133395	351.946	Rp 1 1/2	NBR	4.2 - 8	-20 to 80	40	96.0	180.0
133396	351.947	Rp 2	NBR	4.2 - 8	-20 to 80	50	109.0	207.0

Coaxial valve, single-acting - spring to close, FKM

Art. No.	Type No.	Thread	Sealant	Pilot pressure bar	Operating temperature °C	DN	H mm	L mm
103735	351.951	Rp 3/8	FKM	4.2 - 8	-20 to 150	10	46.0	98.0
103736	351.952	Rp 1/2	FKM	4.2 - 8	-20 to 150	15	51.7	112.0
103737	351.953	Rp 3/4	FKM	4.2 - 8	-20 to 150	20	63.5	135.0
103738	351.954	Rp 1	FKM	4.2 - 8	-20 to 150	25	69.0	143.0
133397	351.955	Rp 1 1/4	FKM	4.2 - 8	-20 to 150	32	86.0	165.0
133398	351.956	Rp 1 1/2	FKM	4.2 - 8	-20 to 150	40	96.0	180.0
133399	351.957	Rp 2	FKM	4.2 - 8	-20 to 150	50	109.0	207.0



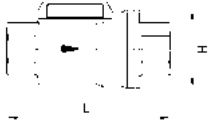

Coaxial valves

pneumatically operated

EASY



351.972

Coaxial valve, single-acting - spring to close, NBR

Art. No.	Type No.	Thread	Sealant	Pilot pressure bar	Operating temperature °C	DN	H mm	L mm
137353	351.971	Rp 3/8	NBR	4.2 - 8	-20 to 80	10	46.0	98.0
137354	351.972	Rp 1/2	NBR	4.2 - 8	-20 to 80	15	51.7	112.0
137355	351.973	Rp 3/4	NBR	4.2 - 8	-20 to 80	20	63.5	135.0
137356	351.974	Rp 1	NBR	4.2 - 8	-20 to 80	25	69.0	143.0
137357	351.975	Rp 1 1/4	NBR	4.2 - 8	-20 to 80	32	86.0	165.0
137358	351.976	Rp 1 1/2	NBR	4.2 - 8	-20 to 80	40	96.0	180.0
137359	351.977	Rp 2	NBR	4.2 - 8	-20 to 80	50	109.0	207.0

Coaxial valve, single-acting - spring to open, FKM

Art. No.	Type No.	Thread	Sealant	Pilot pressure bar	Operating temperature °C	DN	H mm	L mm
137360	351.981	Rp 3/8	FKM	4.2 - 8	-20 to 150	10	46.0	98.0
137361	351.982	Rp 1/2	FKM	4.2 - 8	-20 to 150	15	51.7	112.0
137362	351.983	Rp 3/4	FKM	4.2 - 8	-20 to 150	20	63.5	135.0
137363	351.984	Rp 1	FKM	4.2 - 8	-20 to 150	25	69.0	143.0
137364	351.985	Rp 1 1/4	FKM	4.2 - 8	-20 to 150	32	86.0	165.0
137365	351.986	Rp 1 1/2	FKM	4.2 - 8	-20 to 150	40	96.0	180.0
137366	351.987	Rp 2	FKM	4.2 - 8	-20 to 150	50	109.0	207.0

→ For NAMUR pilot valves look at page 429-431

Angle-seat valves with piston actuator

Bronze version



Angle-seat valves with external pilot control and a self-aligning valve disc for neutral (bronze body) or corrosive (stainless steel body) media.

- Very high flow due to angled seat design
- Water hammer prevented by fluid entry under the disc
- Suitable for vacuum operation (low vacuum)

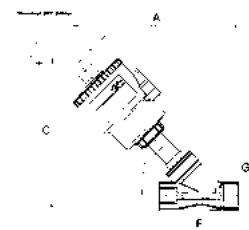

Medium temperature	-10 to 180 °C
Ambient temperature	-20 to 70 °C
Differential pressure	0 - 16 bar
Permissible static pressure max.	16 bar
Pilot fluid temperature max.	60 °C
Housing	Bronze
Sealant	PTFE
Stem	Stainless steel
Operator	Polyamide (glass fibre-reinforced)
Control air port	G 1/8

Angle-seat valve with piston actuator, NC function

Art. No.	Type No.	Thread	Max. operating pressure difference bar	Piston	Pilot pressure bar	A mm	C mm	F mm
133197	3362.01	G 1/2	16	Nickel-plated brass	4 - 10	163.0	153.0	65.0
133198	3362.02	G 3/4	10	Nickel-plated brass	4 - 10	173.0	163.0	75.0
133199	3362.03	G 3/4	16	Nickel-plated brass	4 - 10	191.0	181.0	75.0
133200	3362.04	G 1	11	Nickel-plated brass	4 - 10	206.0	196.0	90.0
133201	3362.05	G 1	16	Nickel-plated brass	4 - 8	246.0	236.0	90.0
133202	3362.06	G 1 1/4	14	Nickel-plated brass	4 - 8	255.0	245.0	110.0
133203	3362.08	G 1 1/2	11	PBT + GF 30 %	4 - 8	270.0	264.0	120.0
133204	3362.09	G 1 1/2	16	PBT + GF 30 %	4 - 8	306.0	300.0	120.0
133205	3362.10	G 2	10	PBT + GF 30 %	4 - 8	316.0	311.0	150.0



3362.04



Accessoire for angle-seat valves with piston actuator

Art. No.	Type No.	Description
131434	NAP	NAMUR adapter plate for angle-seat valves G 1/2 - G 2



NAP

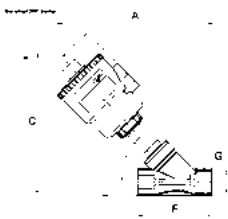

Angle-seat valves with piston actuator

Stainless steel version

Medium temperature	-10 to 180 °C
Ambient temperature	-20 to 70 °C
Differential pressure	0 - 16 bar
Permissible static pressure max.	16 bar
Pilot fluid temperature max.	60 °C
Housing	Stainless steel AISI 316
Sealant	PTFE
Stem	Stainless steel
Operator	Polyamide (glass fibre-reinforced)
Control air port	G 1/8
Piston	Nickel-plated brass
Min. pilot pressure	4 bar
Max. pilot pressure	10 bar



3363.04

Angle-seat valve with piston actuator, NC function

Art. No.	Type No.	Thread	Max. operating pressure difference bar	A mm	C mm	F mm
133206	3363.01	G 1/2	16	190.0	169.0	85.0
133207	3363.02	G 3/4	10	195.0	176.0	95.0
133208	3363.03	G 3/4	16	213.0	195.0	95.0
133209	3363.04	G 1	11	219.0	202.0	105.0



NAP

Accessoire for angle-seat valves with piston actuator

Art. No.	Type No.	Description
131434	NAP	NAMUR adapter plate for angle-seat valves G 1/2 - G 2

Solenoid valves

2/2-way type

Economy series available in three different versions

- Directly operated
- Combined operation
- Pilot-operated

For all applications with compressed air, neutral gases or low-viscosity, neutral media.

2/2-way solenoid valves directly operated

2/2-way type

EASY

Housing	Brass
Valve seat	Brass
Internal parts	Stainless steel
Electrical connection	For connector socket Pg 9/Pg 11 acc. to ISO 4400
Protection IP	IP 65 (with connector socket fitted)
Medium temperature	-10 to 140 °C
Sealant	FPM

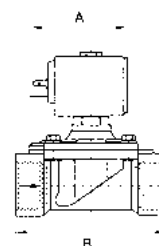

Solenoid valve, normally closed, directly operated, 230 V, 50 - 60 Hz

Art. No.	Type No.	Thread	Operating pressure bar	Ambient temperature °C	DN	A mm	B mm	Type
102883	MV 1311	G 1/8	0 - 18	-10 to 60	2.3	41.0	30.0	1
102884	MV 1312	G 1/8	0 - 6	-10 to 60	2.3	41.0	30.0	1
102885	MV 1313	G 1/8	0 - 14	-10 to 80	2.5	54.0	40.0	2
102886	MV 1314	G 1/8	0 - 10	-10 to 80	3	54.0	40.0	2
102887	MV 1315	G 1/4	0 - 14	-10 to 80	2.5	54.0	40.0	2
102888	MV 1316	G 1/4	0 - 10	-10 to 80	3	54.0	40.0	2
102889	MV 1317	G 1/4	0 - 5	-10 to 80	4.5	54.0	40.0	2



Bauform 1

Solenoid valve, normally closed, directly operated, 24 V DC (direct current)

Art. No.	Type No.	Thread	Operating pressure bar	Ambient temperature °C	DN	A mm	B mm	Type
102890	MV 1321 G	G 1/8	0 - 8	-10 to 60	2.3	41.0	30.0	1
102891	MV 1322 G	G 1/8	0 - 9	-10 to 80	2.5	54.0	40.0	2
102892	MV 1324 G	G 1/8	0 - 6	-10 to 80	3	54.0	40.0	2
102893	MV 1325 G	G 1/4	0 - 9	-10 to 80	2.5	54.0	40.0	2
102894	MV 1326 G	G 1/4	0 - 6	-10 to 80	3	54.0	40.0	2
102895	MV 1327 G	G 1/4	0 - 2	-10 to 80	4.5	54.0	40.0	2



Bauform 2

Solenoid valve, normally open, directly operated, 230 V, 50 to 60 Hz

Art. No.	Type No.	Thread	Operating pressure bar	Ambient temperature °C	DN	A mm	B mm	Type
102896	MV 1331	G 1/8	0 - 20	-10 to 80	2	54.0	40.0	2
102897	MV 1332	G 1/8	0 - 14	-10 to 80	2.5	54.0	40.0	2
102898	MV 1333	G 1/4	0 - 10	-10 to 80	3	54.0	40.0	2
102899	MV 1334	G 1/4	0 - 4	-10 to 80	4.5	54.0	40.0	2

Solenoid valve, normally open, directly operated, 24 V DC (direct current)

Art. No.	Type No.	Thread	Operating pressure bar	Ambient temperature °C	DN	A mm	B mm	Type
102900	MV 1341 G	G 1/8	0 - 20	-10 to 80	2	54.0	40.0	2
102901	MV 1342 G	G 1/8	0 - 14	-10 to 80	2.5	54.0	40.0	2
102902	MV 1343 G	G 1/4	0 - 10	-10 to 80	3	54.0	40.0	2
102903	MV 1344 G	G 1/4	0 - 4	-10 to 80	4.5	54.0	40.0	2

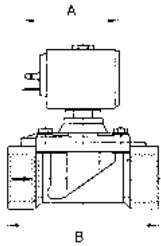

2/2-way solenoid valves combined operation

2/2-way type

EASY

Housing	Brass
Valve seat	Brass
Internal parts	Stainless steel
Electrical connection	For connector socket Pg 9/Pg 11 acc. to ISO 4400
Protection IP	IP 65 (with connector socket fitted)
Medium temperature	-10 to 90 °C
Ambient temperature	-10 to 80 °C
Sealant	NBR
Type	8



Bauform 8

Solenoid valve, normally closed, combined operation, 230 V, 50 to 60 Hz

Art. No.	Type No.	Thread	Operating pressure bar	DN	A mm	B mm
102904	MV 1411	G 3/8	0 - 14	11	54.0	56.0
102905	MV 1412	G 1/2	0 - 14	16	54.0	70.0
102906	MV 1413	G 3/4	0 - 14	16	54.0	70.0
102907	MV 1414	G 1	0 - 14	25	67.0	104.0
102908	MV 1415	G 1	0 - 16	25	54.0	104.0

Solenoid valve, normally closed, combined operation, 24 V DC (direct current)

Art. No.	Type No.	Thread	Operating pressure bar	DN	A mm	B mm
102909	MV 1411 G	G 3/8	0 - 14	11	67.0	56.0
102910	MV 1412 G	G 1/2	0 - 14	16	67.0	70.0
102911	MV 1413 G	G 3/4	0 - 14	16	67.0	70.0
102912	MV 1414 G	G 1	0 - 6	25	67.0	104.0

2/2-way solenoid valves pilot-operated

2/2-way type

EASY

Housing	Brass
Valve seat	Brass
Internal parts	Stainless steel
Electrical connection	For connector socket Pg 9/Pg 11 acc. to ISO 4400
Protection IP	IP 65 (with connector socket fitted)
Ambient temperature	-10 to 80 °C



Bauform 3



Bauform 4

Solenoid valve, normally closed, pilot-operated, 230 V, 50 to 60 Hz

Art. No.	Type No.	Thread	Operating pressure bar	Medium temperature °C	DN	Sealant	A mm	B mm	Type
102914	MV 1352	G 3/8	0.1 - 20	-10 to 90	12	NBR	54.0	50.0	3
102913	MV 1351	G 3/8	0.1 - 20	-10 to 140	12	FPM	54.0	50.0	3
102915	MV 1353	G 3/8	0.2 - 16	-10 to 90	13	NBR	54.0	60.0	4
102916	MV 1354	G 3/8	0.2 - 16	-10 to 140	13	FPM	54.0	60.0	4
102917	MV 1355	G 3/8	0.2 - 16	-10 to 90	13	NBR	40.0	60.0	5
102918	MV 1356	G 3/8	0.2 - 16	-10 to 140	13	FPM	40.0	60.0	5
102920	MV 1358	G 1/2	0.1 - 20	-10 to 90	12	NBR	54.0	50.0	3
102919	MV 1357	G 1/2	0.1 - 20	-10 to 140	12	FPM	54.0	50.0	3
102921	MV 1359	G 1/2	0.2 - 16	-10 to 90	13	NBR	54.0	66.0	4
102922	MV 1360	G 1/2	0.2 - 16	-10 to 140	13	FPM	54.0	66.0	4
102923	MV 1361	G 1/2	0.2 - 16	-10 to 90	13	NBR	40.0	66.0	5
102924	MV 1362	G 1/2	0.2 - 16	-10 to 140	13	FPM	40.0	66.0	5
102925	MV 1363	G 3/4	0.2 - 16	-10 to 90	19	NBR	54.0	104.0	6
102926	MV 1364	G 1	0.2 - 16	-10 to 90	25	NBR	54.0	104.0	6

2/2-way solenoid valves pilot-operated

2/2-way type

EASY

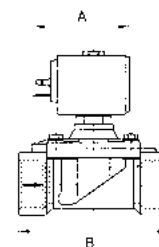

Solenoid valve, normally closed, pilot-operated, 230 V, 50 to 60 Hz

Art. No.	Type No.	Thread	Operating pressure bar	Medium temperature °C	DN	Sealant	A mm	B mm	Type
102927	MV 1365	G 1 1/4	0.2 - 10	-10 to 90	35	NBR	54.0	144.0	6
102928	MV 1366	G 1 1/2	0.2 - 10	-10 to 90	40	NBR	54.0	144.0	6
102929	MV 1367	G 2	0.2 - 10	-10 to 90	50	NBR	54.0	172.0	6



Bauform 5

Solenoid valve, normally closed, pilot-operated, 24 V DC (direct current)

Art. No.	Type No.	Thread	Operating pressure bar	Medium temperature °C	DN	Sealant	A mm	B mm	Type
102931	MV 1362 G	G 3/8	0.1 - 10	-10 to 90	12	NBR	54.0	50.0	3
102930	MV 1361 G	G 3/8	0.1 - 10	-10 to 140	12	FPM	54.0	50.0	3
102932	MV 1363 G	G 3/8	0.2 - 16	-10 to 90	13	NBR	54.0	60.0	4
102933	MV 1364 G	G 3/8	0.2 - 16	-10 to 140	13	FPM	54.0	60.0	4
102934	MV 1365 G	G 3/8	0.2 - 16	-10 to 90	13	NBR	40.0	60.0	5
102935	MV 1366 G	G 3/8	0.2 - 16	-10 to 140	13	FPM	40.0	60.0	5
102937	MV 1368 G	G 1/2	0.1 - 10	-10 to 90	12	NBR	54.0	50.0	3
102936	MV 1367 G	G 1/2	0.1 - 10	-10 to 140	12	FPM	54.0	50.0	3
102938	MV 1369 G	G 1/2	0.2 - 16	-10 to 90	13	NBR	54.0	66.0	4
102939	MV 1370 G	G 1/2	0.2 - 16	-10 to 140	13	FPM	54.0	66.0	4
102940	MV 1371 G	G 1/2	0.2 - 16	-10 to 90	13	NBR	40.0	66.0	5
102941	MV 1372 G	G 1/2	0.2 - 16	-10 to 140	13	FPM	40.0	66.0	5
102942	MV 1373 G	G 3/4	0.2 - 16	-10 to 90	19	NBR	54.0	104.0	6
102943	MV 1374 G	G 1	0.2 - 16	-10 to 90	25	NBR	54.0	104.0	6
102944	MV 1375 G	G 1 1/4	0.2 - 10	-10 to 90	35	NBR	54.0	144.0	6
102945	MV 1376 G	G 1 1/2	0.2 - 10	-10 to 90	40	NBR	54.0	144.0	6
102946	MV 1377 G	G 2	0.2 - 10	-10 to 90	50	NBR	54.0	172.0	6



Bauform 6

Solenoid valve, normally open, pilot-operated, 230 V, 50 to 60 Hz

Art. No.	Type No.	Thread	Operating pressure bar	Medium temperature °C	DN	Sealant	A mm	B mm	Type
102947	MV 1381	G 3/8	0.2 - 16	-10 to 90	13	NBR	54.0	60.0	4
102948	MV 1382	G 1/2	0.2 - 16	-10 to 90	13	NBR	54.0	66.0	4
102949	MV 1383	G 3/4	0.2 - 16	-10 to 90	19	NBR	54.0	104.0	6
102950	MV 1384	G 1	0.2 - 16	-10 to 90	25	NBR	54.0	104.0	6
102951	MV 1385	G 1 1/4	0.2 - 10	-10 to 90	35	NBR	54.0	144.0	6
102952	MV 1386	G 1 1/2	0.2 - 10	-10 to 90	40	NBR	54.0	144.0	6
102953	MV 1387	G 2	0.2 - 10	-10 to 90	50	NBR	54.0	172.0	6

Solenoid valve, normally open, pilot-operated, 24 V DC (direct current)

Art. No.	Type No.	Thread	Operating pressure bar	Medium temperature °C	DN	Sealant	A mm	B mm	Type
102954	MV 1391 G	G 3/8	0.2 - 16	-10 to 90	13	NBR	54.0	60.0	4
102955	MV 1392 G	G 1/2	0.2 - 16	-10 to 90	13	NBR	54.0	66.0	4
102956	MV 1393 G	G 3/4	0.2 - 16	-10 to 90	19	NBR	54.0	104.0	6
102957	MV 1394 G	G 1	0.2 - 16	-10 to 90	25	NBR	54.0	104.0	6
102958	MV 1395 G	G 1 1/4	0.2 - 10	-10 to 90	35	NBR	54.0	144.0	6
102959	MV 1396 G	G 1 1/2	0.2 - 10	-10 to 90	40	NBR	54.0	144.0	6
102960	MV 1397 G	G 2	0.2 - 10	-10 to 90	50	NBR	54.0	172.0	6

Solenoid valves

professional standard series

In many areas, such as plant engineering, process technology or filling technology, solenoid valves are an optimum solution for control and regulation of fluids. With this professional standard series, RIEGLER offers fluid valves designed in Germany and produced in Europe. A consistently managed modular system guarantees a broad spectrum of possible valve forms in regards to sealing materials or valve bodies. If you cannot find your required specification in our standard products, please contact us.

NEW 2/2-way solenoid valves directly operated

professional standard series

PLUS

Housing	Brass
Valve seat	Brass and stainless steel
Internal parts	Brass and stainless steel
Protection IP	IP65 (with connector socket fitted)
Ambient temperature	-20 to 55 °C



MVA.18.MS.230.F.RD.2

Solenoid valve, normally closed, directly operated, alternating current

Art. No.	Type No.	Thread	DN	Voltage	Operating pressure bar	Medium temperature °C	Sealant
129275	MVA.18.MS.230.F.RD.2	G 1/8	2	230V AC	0 - 10	-15 to 100	FPM
129276	MVA.18.MS.230.F.RD.2,5	G 1/8	2.5	230V AC	0 - 8	-15 to 100	FPM
129295	MVA.14.MS.230.F.RD.3	G 1/4	3	230V AC	0 - 20	-15 to 100	FPM
129296	MVA.14.MS.230.F.RD.4	G 1/4	4	230V AC	0 - 10	-15 to 100	FPM

Solenoid valve, normally closed, directly operated, direct current

Art. No.	Type No.	Thread	DN	Voltage	Operating pressure bar	Medium temperature °C	Sealant
129277	MVA.18.MS.24D.F.RD.2	G 1/8	2	24V DC	0 - 8	-15 to 100	FPM
129278	MVA.18.MS.24D.F.RD.2,5	G 1/8	2.5	24V DC	0 - 6.5	-15 to 100	FPM
129297	MVA.14.MS.24D.F.RD.3	G 1/4	3	24V DC	0 - 16	-15 to 100	FPM
129298	MVA.14.MS.24D.F.RD.4	G 1/4	4	24V DC	0 - 8	-15 to 100	FPM



MVA.14.MS.230.F.RD.3

Solenoid valve, normally open, directly operated, alternating current

Art. No.	Type No.	Thread	DN	Voltage	Operating pressure bar	Medium temperature °C	Sealant
129310	MVB.14.MS.230.F.RD.2,5	G 1/4	2.5	230V AC	0 - 10	-15 to 100	FPM
129311	MVB.14.MS.230.F.RD.3	G 1/4	3	230V AC	0 - 6	-15 to 100	FPM

Solenoid valve, normally open, directly operated, direct current

Art. No.	Type No.	Thread	DN	Voltage	Operating pressure bar	Medium temperature °C	Sealant
129312	MVB.14.MS.24D.F.RD.2,5	G 1/4	2.5	24V DC	0 - 8	-15 to 100	FPM
129313	MVB.14.MS.24D.F.RD.3	G 1/4	3	24V DC	0 - 5	-15 to 100	FPM

NEW 2/2-way solenoid valves combined operation

professional standard series

PLUS

Housing	Brass
Valve seat	Brass and stainless steel
Internal parts	Brass and stainless steel
Electrical connection	Connector socket, industrial standard type A – EN 175301-803-A
Protection IP	IP65 (with connector socket fitted)
Ambient temperature	-10 to 50 °C

Solenoid valve, normally closed, combined operation, alternating current

Art. No.	Type No.	Thread	DN	Voltage	Operating pressure bar	Medium temperature °C	Sealant
129435	MVA.38.MS.230.N.RZ.13	G 3/8	13	230V AC	0 - 12	-20 to 85	NBR
129400	MVA.38.MS.230.F.RZ.13	G 3/8	13	230V AC	0 - 12	-10 to 100	FPM
129436	MVA.12.MS.230.N.RZ.13	G 1/2	13	230V AC	0 - 12	-20 to 85	NBR
129401	MVA.12.MS.230.F.RZ.13	G 1/2	13	230V AC	0 - 12	-10 to 100	FPM
129437	MVA.34.MS.230.N.RZ.20	G 3/4	20	230V AC	0 - 12	-20 to 85	NBR
129402	MVA.34.MS.230.F.RZ.20	G 3/4	20	230V AC	0 - 12	-10 to 100	FPM
129438	MVA.1.MS.230.N.RZ.25	G 1	25	230V AC	0 - 12	-20 to 85	NBR
129403	MVA.1.MS.230.F.RZ.25	G 1	25	230V AC	0 - 12	-10 to 100	FPM
129439	MVA.114.MS.230.N.RZ.32	G 1 1/4	32	230V AC	0 - 12	-20 to 85	NBR
129404	MVA.114.MS.230.F.RZ.32	G 1 1/4	32	230V AC	0 - 12	-10 to 100	FPM
129440	MVA.112.MS.230.N.RZ.40	G 1 1/2	40	230V AC	0 - 12	-20 to 85	NBR
129405	MVA.112.MS.230.F.RZ.40	G 1 1/2	40	230V AC	0 - 12	-10 to 100	FPM
129441	MVA.2.MS.230.N.RZ.50	G 2	50	230V AC	0 - 12	-20 to 85	NBR
129406	MVA.2.MS.230.F.RZ.50	G 2	50	230V AC	0 - 12	-10 to 100	FPM



MVA.12.MS.230.F.RZ

Solenoid valve, normally closed, combined operation, direct current

Art. No.	Type No.	Thread	DN	Voltage	Operating pressure bar	Medium temperature °C	Sealant
129442	MVA.38.MS.24D.N.RZ.13	G 3/8	13	24V DC	0 - 12	-20 to 85	NBR
129407	MVA.38.MS.24D.F.RZ.13	G 3/8	13	24V DC	0 - 12	-10 to 100	FPM
129443	MVA.12.MS.24D.N.RZ.13	G 1/2	13	24V DC	0 - 12	-20 to 85	NBR
129408	MVA.12.MS.24D.F.RZ.13	G 1/2	13	24V DC	0 - 12	-10 to 100	FPM
129444	MVA.34.MS.24D.N.RZ.20	G 3/4	20	24V DC	0 - 12	-20 to 85	NBR
129409	MVA.34.MS.24D.F.RZ.20	G 3/4	20	24V DC	0 - 12	-10 to 100	FPM
129445	MVA.1.MS.24D.N.RZ.25	G 1	25	24V DC	0 - 12	-20 to 85	NBR
129410	MVA.1.MS.24D.F.RZ.25	G 1	25	24V DC	0 - 12	-10 to 100	FPM
129446	MVA.114.MS.24D.N.RZ.32	G 1 1/4	32	24V DC	0 - 12	-20 to 85	NBR
129411	MVA.114.MS.24D.F.RZ.32	G 1 1/4	32	24V DC	0 - 12	-10 to 100	FPM
129447	MVA.112.MS.24D.N.RZ.40	G 1 1/2	40	24V DC	0 - 12	-20 to 85	NBR
129412	MVA.112.MS.24D.F.RZ.40	G 1 1/2	40	24V DC	0 - 12	-10 to 100	FPM
129448	MVA.2.MS.24D.N.RZ.50	G 2	50	24V DC	0 - 12	-20 to 85	NBR
129413	MVA.2.MS.24D.F.RZ.50	G 2	50	24V DC	0 - 12	-10 to 100	FPM

Solenoid valve, normally open, combined operation, alternating current

Art. No.	Type No.	Thread	DN	Voltage	Operating pressure bar	Medium temperature °C	Sealant
129478	MVB.38.MS.230.N.RZ.13	G 3/8	13	230V AC	0 - 12	-20 to 85	NBR
129470	MVB.38.MS.230.F.RZ.13	G 3/8	13	230V AC	0 - 12	-10 to 100	FPM
129479	MVB.12.MS.230.N.RZ.13	G 1/2	13	230V AC	0 - 12	-20 to 85	NBR
129471	MVB.12.MS.230.F.RZ.13	G 1/2	13	230V AC	0 - 12	-10 to 100	FPM
129480	MVB.34.MS.230.N.RZ.20	G 3/4	20	230V AC	0 - 12	-20 to 85	NBR
129472	MVB.34.MS.230.F.RZ.20	G 3/4	20	230V AC	0 - 12	-10 to 100	FPM
129481	MVB.1.MS.230.N.RZ.25	G 1	25	230V AC	0 - 12	-20 to 85	NBR
129473	MVB.1.MS.230.F.RZ.25	G 1	25	230V AC	0 - 12	-10 to 100	FPM



MVA.34.MS.230.F.RZ.20



NEW 2/2-way solenoid valves combined operation

professional standard series

PLUS

MVA.34.MS.230.F.RZ.20

Solenoid valve, normally open, combined operation, direct current

Art. No.	Type No.	Thread	DN	Voltage	Operating pressure bar	Medium temperature °C	Sealant
129482	MVB.38.MS.24D.N.RZ.13	G 3/8	13	24V DC	0 - 12	-20 to 85	NBR
129474	MVB.38.MS.24D.F.RZ.13	G 3/8	13	24V DC	0 - 12	-10 to 100	FPM
129483	MVB.12.MS.24D.N.RZ.13	G 1/2	13	24V DC	0 - 12	-20 to 85	NBR
129475	MVB.12.MS.24D.F.RZ.13	G 1/2	13	24V DC	0 - 12	-10 to 100	FPM
129484	MVB.34.MS.24D.N.RZ.20	G 3/4	20	24V DC	0 - 12	-20 to 85	NBR
129476	MVB.34.MS.24D.F.RZ.20	G 3/4	20	24V DC	0 - 12	-10 to 100	FPM
129485	MVB.1.MS.24D.N.RZ.25	G 1	25	24V DC	0 - 12	-20 to 85	NBR
129477	MVB.1.MS.24D.F.RZ.25	G 1	25	24V DC	0 - 12	-10 to 100	FPM

NEW 2/2-way solenoid valves pilot-operated

professional standard series

PLUS

Housing	Brass
Valve seat	Brass and stainless steel
Internal parts	Brass and stainless steel
Electrical connection	Connector socket, industrial standard type A – EN 175301-803-A
Protection IP	IP65 (with connector socket fitted)
Ambient temperature	-10 to 50 °C



MVA.12.MS.230.F.RV.13

Solenoid valve, normally closed, pilot-operated, alternating current

Art. No.	Type No.	Thread	DN	Voltage	Operating pressure bar	Medium temperature °C	Sealant
129531	MVA.38.MS.230.N.RV.13	G 3/8	13	230V AC	0.5 - 16	-20 to 85	NBR
129496	MVA.38.MS.230.F.RV.13	G 3/8	13	230V AC	0.5 - 16	-15 to 100	FPM
129532	MVA.12.MS.230.N.RV.13	G 1/2	13	230V AC	0.5 - 16	-20 to 85	NBR
129497	MVA.12.MS.230.F.RV.13	G 1/2	13	230V AC	0.5 - 16	-15 to 100	FPM
129533	MVA.34.MS.230.N.RV.20	G 3/4	20	230V AC	0.5 - 16	-20 to 85	NBR
129498	MVA.34.MS.230.F.RV.20	G 3/4	20	230V AC	0.5 - 16	-15 to 100	FPM
129534	MVA.1.MS.230.N.RV.25	G 1	25	230V AC	0.5 - 16	-20 to 85	NBR
129499	MVA.1.MS.230.F.RV.25	G 1	25	230V AC	0.5 - 16	-15 to 100	FPM
129535	MVA.114.MS.230.N.RV.32	G 1 1/4	32	230V AC	0.5 - 12	-20 to 85	NBR
129500	MVA.114.MS.230.F.RV.32	G 1 1/4	32	230V AC	0.5 - 12	-15 to 100	FPM
129536	MVA.112.MS.230.N.RV.40	G 1 1/2	40	230V AC	0.5 - 12	-20 to 85	NBR
129501	MVA.112.MS.230.F.RV.40	G 1 1/2	40	230V AC	0.5 - 12	-15 to 100	FPM
129537	MVA.2.MS.230.N.RV.50	G 2	50	230V AC	0.5 - 10	-20 to 85	NBR
129502	MVA.2.MS.230.F.RV.50	G 2	50	230V AC	0.5 - 10	-15 to 100	FPM

NEW 2/2-way solenoid valves pilot-operated

professional standard series

PLUS

MVB.12.MS.230.F.RV.13

Solenoid valve, normally closed, pilot-operated, direct current							
Art. No.	Type No.	Thread	DN	Voltage	Operating pressure bar	Medium temperature °C	Sealant
129538	MVA.38.MS.24D.N.RV.13	G 3/8	13	24V DC	0.5 - 16	-20 to 85	NBR
129503	MVA.38.MS.24D.F.RV.13	G 3/8	13	24V DC	0.5 - 16	-15 to 100	FPM
129539	MVA.12.MS.24D.N.RV.13	G 1/2	13	24V DC	0.5 - 16	-20 to 85	NBR
129504	MVA.12.MS.24D.F.RV.13	G 1/2	13	24V DC	0.5 - 16	-15 to 100	FPM
129540	MVA.34.MS.24D.N.RV.20	G 3/4	20	24V DC	0.5 - 16	-20 to 85	NBR
129505	MVA.34.MS.24D.F.RV.20	G 3/4	20	24V DC	0.5 - 16	-15 to 100	FPM
129541	MVA.1.MS.24D.N.RV.25	G 1	25	24V DC	0.5 - 16	-20 to 85	NBR
129506	MVA.1.MS.24D.F.RV.25	G 1	25	24V DC	0.5 - 16	-15 to 100	FPM
129542	MVA.114.MS.24D.N.RV.32	G 1 1/4	32	24V DC	0.5 - 12	-20 to 85	NBR
129507	MVA.114.MS.24D.F.RV.32	G 1 1/4	32	24V DC	0.5 - 12	-15 to 100	FPM
129543	MVA.112.MS.24D.N.RV.40	G 1 1/2	40	24V DC	0.5 - 12	-20 to 85	NBR
129508	MVA.112.MS.24D.F.RV.40	G 1 1/2	40	24V DC	0.5 - 12	-15 to 100	FPM
129544	MVA.2.MS.24D.N.RV.50	G 2	50	24V DC	0.5 - 10	-20 to 85	NBR
129509	MVA.2.MS.24D.F.RV.50	G 2	50	24V DC	0.5 - 10	-15 to 100	FPM

Solenoid valve, normally open, pilot-operated, alternating current							
Art. No.	Type No.	Thread	DN	Voltage	Operating pressure bar	Medium temperature °C	Sealant
129601	MVB.38.MS.230.N.RV.13	G 3/8	13	230V AC	0.5 - 12	-20 to 85	NBR
129566	MVB.38.MS.230.F.RV.13	G 3/8	13	230V AC	0.5 - 12	-15 to 100	FPM
129602	MVB.12.MS.230.N.RV.13	G 1/2	13	230V AC	0.5 - 12	-20 to 85	NBR
129567	MVB.12.MS.230.F.RV.13	G 1/2	13	230V AC	0.5 - 12	-15 to 100	FPM
129603	MVB.34.MS.230.N.RV.20	G 3/4	20	230V AC	0.5 - 12	-20 to 85	NBR
129568	MVB.34.MS.230.F.RV.20	G 3/4	20	230V AC	0.5 - 12	-15 to 100	FPM
129604	MVB.1.MS.230.N.RV.25	G 1	25	230V AC	0.5 - 12	-20 to 85	NBR
129569	MVB.1.MS.230.F.RV.25	G 1	25	230V AC	0.5 - 12	-15 to 100	FPM
129605	MVB.114.MS.230.N.RV.32	G 1 1/4	32	230V AC	0.5 - 10	-20 to 85	NBR
129570	MVB.114.MS.230.F.RV.32	G 1 1/4	32	230V AC	0.5 - 10	-15 to 100	FPM
129606	MVB.112.MS.230.N.RV.40	G 1 1/2	40	230V AC	0.5 - 10	-20 to 85	NBR
129571	MVB.112.MS.230.F.RV.40	G 1 1/2	40	230V AC	0.5 - 10	-15 to 100	FPM
129607	MVB.2.MS.230.N.RV.50	G 2	50	230V AC	0.5 - 10	-20 to 85	NBR
129572	MVB.2.MS.230.F.RV.50	G 2	50	230V AC	0.5 - 10	-15 to 100	FPM

Solenoid valve, normally open, pilot-operated, direct current							
Art. No.	Type No.	Thread	DN	Voltage	Operating pressure bar	Medium temperature °C	Sealant
129608	MVB.38.MS.24D.N.RV.13	G 3/8	13	24V DC	0.5 - 12	-20 to 85	NBR
129573	MVB.38.MS.24D.F.RV.13	G 3/8	13	24V DC	0.5 - 12	-15 to 100	FPM
129609	MVB.12.MS.24D.N.RV.13	G 1/2	13	24V DC	0.5 - 12	-20 to 85	NBR
129574	MVB.12.MS.24D.F.RV.13	G 1/2	13	24V DC	0.5 - 12	-15 to 100	FPM
129610	MVB.34.MS.24D.N.RV.20	G 3/4	20	24V DC	0.5 - 12	-20 to 85	NBR
129575	MVB.34.MS.24D.F.RV.20	G 3/4	20	24V DC	0.5 - 12	-15 to 100	FPM
129611	MVB.1.MS.24D.N.RV.25	G 1	25	24V DC	0.5 - 12	-20 to 85	NBR
129576	MVB.1.MS.24D.F.RV.25	G 1	25	24V DC	0.5 - 12	-15 to 100	FPM
129612	MVB.114.MS.24D.N.RV.32	G 1 1/4	32	24V DC	0.5 - 10	-20 to 85	NBR
129577	MVB.114.MS.24D.F.RV.32	G 1 1/4	32	24V DC	0.5 - 10	-15 to 100	FPM
129613	MVB.112.MS.24D.N.RV.40	G 1 1/2	40	24V DC	0.5 - 10	-20 to 85	NBR
129578	MVB.112.MS.24D.F.RV.40	G 1 1/2	40	24V DC	0.5 - 10	-15 to 100	FPM
129614	MVB.2.MS.24D.N.RV.50	G 2	50	24V DC	0.5 - 10	-20 to 85	NBR
129579	MVB.2.MS.24D.F.RV.50	G 2	50	24V DC	0.5 - 10	-15 to 100	FPM

Solenoid valves

2/2-way type

Standard series, proven over many years, available in three different versions

- Directly operated
- Combined operation
- Pilot-operated

For all applications with compressed air, neutral gases or low-viscosity, neutral media.

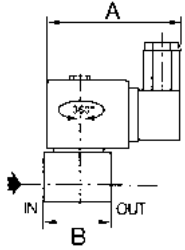

2/2-ways solenoid valves directly operated

2/2-way type

MAX

Housing	Brass
Valve seat	Brass
Internal parts	Stainless steel
Electrical connection	ISO 4400, cable socket (Pg 11P)
Protection IP	IP65 (with connector socket fitted)



Bauform 1



Bauform 2



Bauform 7

Solenoid valve, normally closed, directly operated, 230 V, 50 to 60 Hz

Art. No.	Type No.	Thread	Operating pressure bar	Medium temperature °C	DN	Sealant	A mm	B mm	Type
102819	MV 1214	G 1/8	0 - 12	-25 to 80	3.2	NBR	75.0	30.0	1
102820	MV 1224	G 1/8	0 - 12	-15 to 100	3.2	FPM	75.0	30.0	1
102821	MV 1215	G 1/4	0 - 12	-25 to 80	3.2	NBR	91.0	30.0	2
102822	MV 1225	G 1/4	0 - 12	-15 to 100	3.2	FPM	91.0	30.0	2

Solenoid valve, normally closed, directly operated, 24 V DC (direct current)

Art. No.	Type No.	Thread	Operating pressure bar	Medium temperature °C	DN	Sealant	A mm	B mm	Type
102823	MV 1214 G	G 1/8	0 - 8	-25 to 80	3.2	NBR	75.0	30.0	1
102824	MV 1224 G	G 1/8	0 - 8	-15 to 120	3.2	FPM	75.0	30.0	1
102825	MV 1215 G	G 1/4	0 - 8	-25 to 80	3.2	NBR	91.0	30.0	2
102826	MV 1225 G	G 1/4	0 - 8	-15 to 120	3.2	FPM	91.0	30.0	2

Solenoid valve, normally open, directly operated, 230 V, 50 to 60 Hz

Art. No.	Type No.	Thread	Operating pressure bar	Medium temperature °C	DN	Sealant	A mm	B mm	Type
102827	MV 2214	Rp 1/8	0 - 18	-25 to 80	2.4	NBR	75.0	33.0	7
102828	MV 2234	Rp 1/8	0 - 18	-15 to 100	2.4	FPM	75.0	33.0	1
102829	MV 2215	G 1/4	0 - 11	-25 to 80	3.2	NBR	80.0	40.0	2
102830	MV 2235	G 1/4	0 - 11	-15 to 100	3.2	FPM	80.0	40.0	2

Solenoid valve normally open, directly operated, 24 V DC (direct current)

Art. No.	Type No.	Thread	Operating pressure bar	Medium temperature °C	DN	Sealant	A mm	B mm	Type
102831	MV 2214 G	Rp 1/8	0 - 11	-25 to 80	2.4	NBR	75.0	33.0	7
102832	MV 2215 G	G 1/4	0 - 6.5	-25 to 80	3.2	NBR	80.0	40.0	2

2/2-way solenoid valves combined operation

2/2-way type

MAX

Housing	Brass
Valve seat	Brass
Internal parts	Stainless steel
Electrical connection	ISO 4400; cable socket (Pg 11P)
Protection IP	IP65 (with connector socket fitted)
Type	3
Ambient temperature	-20 to 50 °C
Standard thread	Rp thread acc. to ISO 7-1

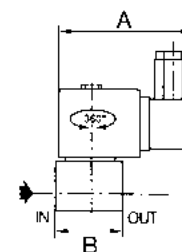

Bauform 3



Solenoid valve, normally closed, combined operation, 230 V, 50 to 60 Hz

Art. No.	Type No.	Thread	Operating pressure bar	Medium temperature °C	DN	Sealant	A mm	B mm
102833	MV 1216/0	Rp 3/8	0 - 9	-20 to 85	16	NBR	80.0	70.0
102834	MV 1226/0	Rp 3/8	0 - 9	-20 to 120	16	FKM	80.0	70.0
102835	MV 1217/0	Rp 1/2	0 - 9	-20 to 85	16	NBR	80.0	70.0
102836	MV 1227/0	Rp 1/2	0 - 9	-20 to 120	16	FKM	80.0	70.0
102837	MV 1218/0	Rp 3/4	0 - 9	-20 to 85	19	NBR	80.0	73.0
102838	MV 1228/0	Rp 3/4	0 - 9	-20 to 120	19	FKM	80.0	73.0
102839	MV 1219/0	Rp 1	0 - 9	-20 to 85	25	NBR	86.0	95.0
102840	MV 1229/0	Rp 1	0 - 9	-20 to 120	25	FKM	86.0	95.0
102841	MV 1220/0	Rp 1 1/4	0 - 9	-20 to 85	28	NBR	86.0	95.0
137595	MV 1230/0	Rp 1 1/4	0 - 9	-20 to 120	28	FKM	86.0	95.0
102842	MV 1221/0	Rp 1 1/2	0 - 9	-20 to 85	32	NBR	86.0	111.0
137596	MV 1231/0	Rp 1 1/2	0 - 9	-20 to 120	32	FKM	86.0	111.0

Solenoid valve, normally closed, combined operation, 24 V DC (direct current)

Art. No.	Type No.	Thread	Operating pressure bar	Medium temperature °C	DN	Sealant	A mm	B mm
102843	MV 1216 G/0	Rp 3/8	0 - 3	-20 to 85	16	NBR	80.0	70.0
136140	MV 1226 G/0	Rp 3/8	0 - 3	-20 to 120	16	FKM	80.0	70.0
102844	MV 1217 G/0	Rp 1/2	0 - 3	-20 to 85	16	NBR	80.0	70.0
136141	MV 1227 G/0	Rp 1/2	0 - 3	-20 to 120	16	FKM	80.0	70.0
136142	MV 1218 G/0	Rp 3/4	0 - 3	-20 to 85	19	NBR	80.0	73.0
136143	MV 1228 G/0	Rp 3/4	0 - 3	-20 to 120	19	FKM	80.0	73.0
136144	MV 1219 G/0	Rp 1	0 - 6	-20 to 85	25	NBR	86.0	95.0
136145	MV 1229 G/0	Rp 1	0 - 6	-20 to 120	25	FKM	86.0	95.0
136146	MV 1220 G/0	Rp 1 1/4	0 - 6	-20 to 85	28	NBR	86.0	95.0
137597	MV 1230 G/0	Rp 1 1/4	0 - 6	-20 to 120	28	FKM	86.0	95.0
136147	MV 1221 G/0	Rp 1 1/2	0 - 5	-20 to 85	32	NBR	86.0	111.0
137598	MV 1231 G/0	Rp 1 1/2	0 - 5	-20 to 120	32	FKM	86.0	111.0

Solenoid valve, normally open, combined operation, 230 V, 50 to 60 Hz

Art. No.	Type No.	Thread	Operating pressure bar	Medium temperature °C	DN	Sealant	A mm	B mm
102845	MV 2216	Rp 3/8	0 - 9	-20 to 85	16	NBR	80.0	70.0
102846	MV 2236	Rp 3/8	0 - 9	-20 to 120	16	FKM	80.0	70.0
102847	MV 2217	Rp 1/2	0 - 9	-20 to 85	16	NBR	80.0	70.0
102848	MV 2237	Rp 1/2	0 - 9	-20 to 120	16	FKM	80.0	70.0
102849	MV 2218	Rp 3/4	0 - 9	-20 to 85	19	NBR	80.0	70.0
102850	MV 2238	Rp 3/4	0 - 9	-20 to 120	19	FKM	80.0	70.0
136148	MV 2219	Rp 1	0 - 9	-20 to 85	25	NBR	86.0	95.0
136149	MV 2239	Rp 1	0 - 9	-20 to 120	25	FKM	86.0	95.0
136150	MV 2220	Rp 1 1/4	0 - 9	-20 to 85	28	NBR	86.0	95.0
136151	MV 2221	Rp 1 1/2	0 - 9	-20 to 85	32	NBR	86.0	111.0

Solenoid valve, normally open, combined operation, 24 V DC (direct current)

Art. No.	Type No.	Thread	Operating pressure bar	Medium temperature °C	DN	Sealant	A mm	B mm
102851	MV 2216 G	Rp 3/8	0 - 9	-20 to 85	16	NBR	80.0	70.0
136152	MV 2236 G	Rp 3/8	0 - 9	-20 to 120	16	FKM	80.0	70.0

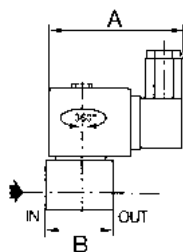

2/2-way solenoid valves combined operation

2/2-way type

MAX

Solenoid valve, normally open, combined operation, 24 V DC (direct current)

Art. No.	Type No.	Thread	Operating pressure bar	Medium temperature °C	DN	Sealant	A mm	B mm
102852	MV 2217 G	Rp 1/2	0 - 9	-20 to 85	16	NBR	80.0	70.0
136153	MV 2237 G	Rp 1/2	0 - 9	-20 to 120	16	FKM	80.0	70.0
102853	MV 2218 G	Rp 3/4	0 - 9	-20 to 85	19	NBR	80.0	70.0
136154	MV 2238 G	Rp 3/4	0 - 9	-20 to 120	19	FKM	80.0	70.0

2/2-way solenoid valves pilot-operated

2/2-way type

MAX

Housing	Brass
Valve seat	Brass
Internal parts	Stainless steel
Electrical connection	ISO 4400; cable socket (Pg 11P)
Protection IP	IP65 (with connector socket fitted)
Ambient temperature	-20 to 50 °C
Standard thread	Rp thread acc. to ISO 7-1

Solenoid valve, normally closed, pilot-operated, 230 V, 50 to 60 Hz

Art. No.	Type No.	Thread	Operating pressure bar	Medium temperature °C	DN	Sealant	A mm	B mm	Type
102854	MV 1216	Rp 3/8	0.35 - 14	-20 to 85	16	NBR	75.0	70.0	3
102855	MV 1226	Rp 3/8	0.35 - 14	-20 to 120	16	FKM	75.0	70.0	3
102856	MV 1217	Rp 1/2	0.35 - 14	-20 to 85	16	NBR	75.0	70.0	3
102857	MV 1227	Rp 1/2	0.35 - 14	-20 to 120	16	FKM	75.0	70.0	3
102858	MV 1218	Rp 3/4	0.35 - 9	-20 to 85	19	NBR	75.0	71.0	3
102859	MV 1228	Rp 3/4	0.35 - 9	-20 to 120	19	FKM	75.0	71.0	3
102860	MV 1219	Rp 1	0.35 - 9	-20 to 85	25	NBR	75.0	95.0	4
102861	MV 1229	Rp 1	0.35 - 9	-20 to 120	25	FKM	75.0	95.0	4
102862	MV 1220	Rp 1 1/4	0.35 - 9	-20 to 85	28	NBR	75.0	95.0	4
102863	MV 1230	Rp 1 1/4	0.35 - 9	-20 to 120	28	FKM	75.0	95.0	4
102864	MV 1221	Rp 1 1/2	0.35 - 9	-20 to 85	32	NBR	75.0	111.0	5
102865	MV 1231	Rp 1 1/2	0.35 - 9	-20 to 120	32	FKM	75.0	111.0	5
102866	MV 1222	Rp 2	0.35 - 9	-20 to 85	44	NBR	75.0	129.0	5



Bauform 3



Bauform 4



Bauform 5

Solenoid valve, normally closed, pilot-operated, 24 V DC (direct current)

Art. No.	Type No.	Thread	Operating pressure bar	Medium temperature °C	DN	Sealant	A mm	B mm	Type
102867	MV 1216 G	Rp 3/8	0.35 - 9	-20 to 85	16	NBR	80.0	70.0	3
102868	MV 1226 G	Rp 3/8	0.35 - 9	-20 to 120	16	FKM	80.0	70.0	3
102869	MV 1217 G	Rp 1/2	0.35 - 9	-20 to 85	16	NBR	80.0	70.0	3
102870	MV 1227 G	Rp 1/2	0.35 - 9	-20 to 120	16	FKM	80.0	70.0	3
102871	MV 1218 G	Rp 3/4	0.35 - 7	-20 to 85	19	NBR	80.0	71.0	3
102872	MV 1228 G	Rp 3/4	0.35 - 7	-20 to 120	19	FKM	80.0	71.0	3
102873	MV 1219 G	Rp 1	0.35 - 9	-20 to 85	25	NBR	80.0	95.0	4
102874	MV 1229 G	Rp 1	0.35 - 9	-20 to 120	25	FKM	80.0	95.0	4
102875	MV 1220 G	Rp 1 1/4	0.35 - 9	-20 to 85	28	NBR	80.0	95.0	4
102876	MV 1230 G	Rp 1 1/4	0.35 - 9	-20 to 120	28	FKM	80.0	95.0	4
102877	MV 1221 G	Rp 1 1/2	0.35 - 9	-20 to 85	32	NBR	80.0	111.0	5
102878	MV 1231 G	Rp 1 1/2	0.35 - 9	-20 to 120	32	FKM	80.0	111.0	5
102879	MV 1222 G	Rp 2	0.35 - 3	-20 to 85	44	NBR	80.0	129.0	5

Solenoid valves

media-separated

Media-separated solenoid valves are an important component in the control of fluids in systems. With these direct or pilot operated valves only the fluid housing and the separating diaphragm come into contact with the medium.

Thus, these valves can withstand many different media (see resistance chart). In addition, the brass housing meets all the conventional potable water requirements. The direct controlled valve in the 3/2-way design can be used either as a mixing valve or for any desired flow direction. The pilot operated valve is normally closed in the basic position. By simply turning the 3/2-way pilot valve, the basic position can be changed to normally open.

NEW 2/2-way solenoid valve, directly operated

media-separated

MAX |||

Housing	Brass
Valve seat	Brass
Internal parts	Brass
Electrical connection	Pin terminal acc. to DIN EN 175301-803
Protection IP	IP65 (with connector socket fitted)
Ambient temperature	0 to 55 °C

Media-separated 2/2-way solenoid valve, normally closed, directly operated, alternating current

Art. No.	Type No.	Thread	DN	Voltage	Operating pressure bar	Medium temperature °C	Sealant
125752	MVA.14.MS.230.N.BD.3	G 1/4	3	230V AC	0 - 10	0 to 80	NBR
125563	MVA.14.MS.230.F.BD.3	G 1/4	3	230V AC	0 - 10	0 to 90	FPM
125753	MVA.14.MS.230.N.BD.4	G 1/4	4	230V AC	0 - 5	0 to 80	NBR
125751	MVA.14.MS.230.F.BD.4	G 1/4	4	230V AC	0 - 5	0 to 90	FPM

Media-separated 2/2-way solenoid valve, normally closed, directly operated, direct current

Art. No.	Type No.	Thread	DN	Voltage	Operating pressure bar	Medium temperature °C	Sealant
125760	MVA.14.MS.24D.N.BD.3	G 1/4	3	24V DC	0 - 10	0 to 80	NBR
125758	MVA.14.MS.24D.F.BD.3	G 1/4	3	24V DC	0 - 10	0 to 90	FPM
125761	MVA.14.MS.24D.N.BD.4	G 1/4	4	24V DC	0 - 5	0 to 80	NBR
125759	MVA.14.MS.24D.F.BD.4	G 1/4	4	24V DC	0 - 5	0 to 90	FPM

Media-separated 2/2-way solenoid valve, normally open, directly operated, alternating current

Art. No.	Type No.	Thread	DN	Voltage	Operating pressure bar	Medium temperature °C	Sealant
125793	MVB.14.MS.230.N.BD.3	G 1/4	3	230V AC	0 - 10	0 to 80	NBR
125791	MVB.14.MS.230.F.BD.3	G 1/4	3	230V AC	0 - 10	0 to 90	FPM
125794	MVB.14.MS.230.N.BD.4	G 1/4	4	230V AC	0 - 5	0 to 80	NBR
125792	MVB.14.MS.230.F.BD.4	G 1/4	4	230V AC	0 - 5	0 to 90	FPM

Media-separated 2/2-way solenoid valve, normally open, directly operated, direct current

Art. No.	Type No.	Thread	DN	Voltage	Operating pressure bar	Medium temperature °C	Sealant
125801	MVB.14.MS.24D.N.BD.3	G 1/4	3	24V DC	0 - 10	0 to 80	NBR
125799	MVB.14.MS.24D.F.BD.3	G 1/4	3	24V DC	0 - 10	0 to 90	FPM
125802	MVB.14.MS.24D.N.BD.4	G 1/4	4	24V DC	0 - 5	0 to 80	NBR
125800	MVB.14.MS.24D.F.BD.4	G 1/4	4	24V DC	0 - 5	0 to 90	FPM

→ Solenoid valves are supplied without a connector socket as standard.
The connector socket must be ordered separately if required. See page 334



MVA.14.MS.110.F.BD.3



NEW 2/2-way solenoid valve, pilot-operated

media-separated

MAX

Housing	Brass
Valve seat	Brass and stainless steel
Internal parts	Brass and stainless steel
Electrical connection	Pin terminal acc. to DIN EN 175301-803
Protection IP	IP65 (with connector socket fitted)
Ambient temperature	0 to 55 °C



MVA.1.MS.110.F.BV.25

Media-separated 2/2-way solenoid valve, normally closed pilot-operated, alternating current

Art. No.	Type No.	Thread	DN	Voltage	Operating pressure bar	Medium temperature °C	Sealant
124891	MVA.12.MS.230.N.BV.13	G 1/2	13	230V AC	0.2 - 10	0 to 80	NBR
124853	MVA.12.MS.230.F.BV.13	G 1/2	13	230V AC	0.2 - 10	0 to 90	FPM
125780	MVA.34.MS.230.N.BV.20	G 3/4	20	230V AC	0.2 - 10	0 to 80	NBR
125779	MVA.34.MS.230.F.BV.20	G 3/4	20	230V AC	0.2 - 10	0 to 90	FPM
124741	MVA.1.MS.230.N.BV.25	G 1	25	230V AC	0.2 - 10	0 to 80	NBR
124740	MVA.1.MS.230.F.BV.25	G 1	25	230V AC	0.2 - 10	0 to 90	FPM
124760	MVA.114.MS.230.N.BV.32	G 1 1/4	32	230V AC	0.2 - 10	0 to 80	NBR
124759	MVA.114.MS.230.F.BV.32	G 1 1/4	32	230V AC	0.2 - 10	0 to 90	FPM
124752	MVA.112.MS.230.N.BV.40	G 1 1/2	40	230V AC	0.2 - 10	0 to 80	NBR
124751	MVA.112.MS.230.F.BV.40	G 1 1/2	40	230V AC	0.2 - 10	0 to 90	FPM
125765	MVA.2.MS.230.N.BV.50	G 2	50	230V AC	0.2 - 10	0 to 80	NBR
125764	MVA.2.MS.230.F.BV.50	G 2	50	230V AC	0.2 - 10	0 to 90	FPM
125774	MVA.212.MS.230.N.BV.65	G 2 1/2	65	230V AC	0.2 - 10	0 to 80	NBR
125772	MVA.212.MS.230.F.BV.65	G 2 1/2	65	230V AC	0.2 - 10	0 to 90	FPM

Media-separated 2/2-way solenoid valve, normally closed pilot-operated, direct current

Art. No.	Type No.	Thread	DN	Voltage	Operating pressure bar	Medium temperature °C	Sealant
124888	MVA.12.MS.24D.N.BV.13	G 1/2	13	24V DC	0.2 - 10	0 to 80	NBR
124892	MVA.12.MS.24D.F.BV.13	G 1/2	13	24V DC	0.2 - 10	0 to 90	FPM
125784	MVA.34.MS.24D.N.BV.20	G 3/4	20	24V DC	0.2 - 10	0 to 80	NBR
125783	MVA.34.MS.24D.F.BV.20	G 3/4	20	24V DC	0.2 - 10	0 to 90	FPM
124748	MVA.1.MS.24D.N.BV.25	G 1	25	24V DC	0.2 - 10	0 to 80	NBR
124747	MVA.1.MS.24D.F.BV.25	G 1	25	24V DC	0.2 - 10	0 to 90	FPM
124851	MVA.114.MS.24D.N.BV.32	G 1 1/4	32	24V DC	0.2 - 10	0 to 80	NBR
124850	MVA.114.MS.24D.F.BV.32	G 1 1/4	32	24V DC	0.2 - 10	0 to 90	FPM
124756	MVA.112.MS.24D.N.BV.40	G 1 1/2	40	24V DC	0.2 - 10	0 to 80	NBR
124755	MVA.112.MS.24D.F.BV.40	G 1 1/2	40	24V DC	0.2 - 10	0 to 90	FPM
125769	MVA.2.MS.24D.N.BV.50	G 2	50	24V DC	0.2 - 10	0 to 80	NBR
125768	MVA.2.MS.24D.F.BV.50	G 2	50	24V DC	0.2 - 10	0 to 90	FPM
125771	MVA.212.MS.24D.N.BV.65	G 2 1/2	65	24V DC	0.2 - 10	0 to 80	NBR
125775	MVA.212.MS.24D.F.BV.65	G 2 1/2	65	24V DC	0.2 - 10	0 to 90	FPM

→ Solenoid valves are supplied without a connector socket as standard.
The connector socket must be ordered separately if required. See page 334

NEW 3/2-way pilot valve

for media for media-separated solenoid valve

3/2-way pilot valve

Art. No.	Type No.	Sealant	Voltage
129201	MPV.W.MS.24A.N	NBR	24VAC
129203	MPV.W.MS.24A.F	FPM	24VAC
129197	MPV.W.MS.24D.N	NBR	24VDC
129202	MPV.W.MS.24D.F	FPM	24VDC
129198	MPV.W.MS.110.N	NBR	110V
129204	MPV.W.MS.110.F	FPM	110V
129200	MPV.W.MS.230.N	NBR	230V
129199	MPV.W.MS.230.F	FPM	230V



MPV.W.MS.24D.N

NEW 3/2-way solenoid valve, directly operated**MAX**

Housing	Brass
Valve seat	Brass
Internal parts	Brass
Electrical connection	Pin terminal acc. to DIN EN 175301-803
Protection IP	IP65 (with connector socket fitted)
Ambient temperature	0 to 55 °C

**Media-separated 3/2-way solenoid valve, normally closed, directly operated, alternating current**

Art. No.	Type No.	Thread	DN	Voltage	Operating pressure bar	Medium temperature °C	Sealant
125807	MVC.14.MS.230.N.BD.3	G 1/4	3	230V AC	0 - 10	0 to 80	NBR
125808	MVC.14.MS.230.N.BD.4	G 1/4	4	230V AC	0 - 5	0 to 80	NBR



MVC.14.MS.110.N.BD.3

Media-separated 3/2-way solenoid valve, normally closed, directly operated, direct current

Art. No.	Type No.	Thread	DN	Voltage	Operating pressure bar	Medium temperature °C	Sealant
125811	MVC.14.MS.24D.N.BD.3	G 1/4	3	24V DC	0 - 10	0 to 80	NBR
125812	MVC.14.MS.24D.N.BD.4	G 1/4	4	24V DC	0 - 5	0 to 80	NBR

Media-separated 3/2-way solenoid valve, flow direction optional, directly operated, alternating current

Art. No.	Type No.	Thread	DN	Voltage	Operating pressure bar	Medium temperature °C	Sealant
125818	MVW.14.MS.230.F.BD.2	G 1/4	2	230V AC	0 - 12	0 to 90	FPM
125819	MVW.14.MS.230.F.BD.3	G 1/4	3	230V AC	0 - 8	0 to 90	FPM

Media-separated 3/2-way solenoid valve, flow direction optional, directly operated, direct current

Art. No.	Type No.	Thread	DN	Voltage	Operating pressure bar	Medium temperature °C	Sealant
125822	MVW.14.MS.24D.F.BD.2	G 1/4	2	24V DC	0 - 12	0 to 90	FPM
125823	MVW.14.MS.24D.F.BD.3	G 1/4	3	24V DC	0 - 8	0 to 90	FPM

→ Solenoid valves are supplied without a connector socket as standard.
The connector socket must be ordered separately if required. See page 334

3

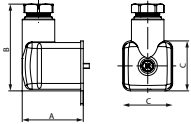

GS.MV.0-250V

NEW Connector socket

for media-separated solenoid valve

Connector socket for media-separated solenoid valve

Art. No.	Type No.	Protection IP	A mm	B mm	C mm
124691	GS.MV.0-250V	IP65/IP67	35.7	51.0	29.2
124702	GS.MV.12-24V	IP65	35.7	51.0	29.2
129205	GS.MV.LED.240V	IP65	35.7	51.0	29.2

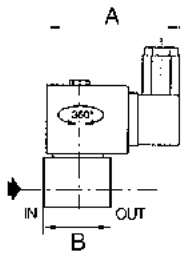

Solenoid valves

3/2-way type - normally closed - brass

MAX

Applications	Compressed air and neutral, non-toxic gases, water, oil
Housing	Brass
Internal parts	Stainless steel
Sealant	FPM
Electrical connection	Connector socket, can be rotated 180°, PG7 acc. to 43650
Function	interchangeable magnetic heads (AC/DC)
Protection IP	IP 65 (with connector socket fitted)
Medium temperature	-10 to 100 °C
Ambient temperature	-10 to 60 °C
DN	1.2
Operating pressure	0 - 15 bar



107.12

Solenoid valve, normally closed, directly operated

Art. No.	Type No.	Thread	Voltage	A mm	B mm
102961	107.11	G 1/8	230/50 V AC, 50 Hz	58.0	33.0
102962	107.12	G 1/8	24 V DC	58.0	33.0

Solenoid valves

3/2-way type

MAX

For all applications with compressed air, neutral gases or low-viscosity, neutral media.

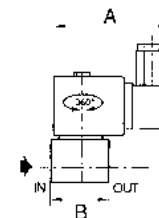

Housing	Brass
Valve seat	Brass
Internal parts	Stainless steel
Sealant	NBR
Electrical connection	For Pg 11P connector socket acc. to ISO 4400
Protection IP	IP65 (with connector socket fitted)
Medium temperature	-20 to 90 °C
Ambient temperature	-20 to 75 °C
Standard thread	Rp thread acc. to ISO 7-1

3/2-way solenoid valve, normally closed, directly operated, 230 V, 50 to 60 Hz

Art. No.	Type No.	Thread	Operating pressure bar	DN	A mm	B mm	Type
102963	MV 3211	Rp 1/8	0 - 7	2.4	75.0	30.0	7
102964	MV 3212	Rp 1/4	0 - 6	3.2	80.0	43.0	10

3/2-way solenoid valve, normally closed, directly operated, 24 V DC (direct current)

Art. No.	Type No.	Thread	Operating pressure bar	DN	A mm	B mm	Type
102965	MV 3211 G	Rp 1/8	0 - 7	2.4	75.0	30.0	7
102966	MV 3212 G	Rp 1/4	0 - 4	3.2	80.0	43.0	10



Bauform 7



Bauform 10



Solenoid valves

3/2-way type - with banjo connection, NC function

MAX

Compact solenoid valves for mounting directly on the actuator (single-acting cylinder, valve, etc.).

- Optimum installation
Supply port (1), solenoid valve body, coil and cable socket can be rotated 360°
- Manual operator
- Exhaust air restrictor available on request

Housing	Polyamide (glass fibre-reinforced)
Sealant	NBR
Max. operating pressure	10 bar
Medium temperature	-10 to 60 °C
Ambient temperature	-10 to 60 °C
Port 1	Plug connection for hose outside Ø 4 mm
Port 2	G 1/8 thread
Vent port	M5

Solenoid valves for mounting directly on the actuator, normally closed

Art. No.	Type No.	Thread	Voltage	A mm	B mm	C mm	D mm
102967	108.01	G 1/8 ET	230/50 V	79.0	90.0	49.0	58.0
102968	108.02	G 1/8 ET	24 DC	79.0	90.0	49.0	58.0

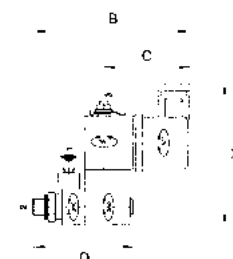

108.01

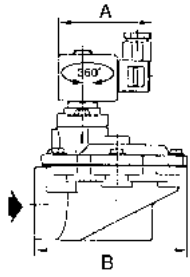

Diaphragm pulse valves

for air pulse cleaning in dust collector systems



Environmental protection today demands state-of-the-art cleaning processes. Dust filter systems are an indispensable aid to pollution control. The fabric filters installed in these systems are cleaned by blowing in compressed air pulses in quick succession counter to the main direction of flow. The solenoid valves used for this purpose are characterised by the following application-specific design features:

- Angle type of construction to optimise the air flow
- Full cross-section at the valve seat
- Extremely fast opening and closing
- Quiet operation thanks to built-in silencers (can be retrofitted in sizes 1 1/2 to 2 1/2)
- Easy maintenance and repair because diaphragm and wearing parts are instantly available

The valves are not suitable as shut-off devices for standard applications.

Housing	Aluminium
Internal parts	Stainless steel
Sealant	NBR
Electrical connection	ISO 4400 (connector socket)
Protection IP	IP65 (with connector socket fitted)
Ambient temperature	-20 to 85 °C



MV 4211-1



MV 4214

Diaphragm pulse valve normally closed, 230 V, 50 to 60 Hz, internal pilot control

Art. No.	Type No.	Thread	Operating pressure bar	Vent port	DN	A mm	B mm	Diaphragms	Medium temperature °C
199900	MV 4211-1	G 3/4	2 - 8.5	-	32	61.0	90.0	TPE	-15 to 85
199901	MV 4212-1	G 1	2 - 8.5	-	32	61.0	90.0	TPE	-15 to 85
199902	MV 4213-1	G 1 1/2	2 - 8.5	G 3/8	55	61.0	132.0	TPE	-15 to 85
102986	MV 4214	G 2	0.35 - 8.5	G 3/4	66	80.0	168.0	CR	-20 to 85
102987	MV 4215	G 2 1/2	0.35 - 8.5	G 3/4	66	80.0	168.0	CR	-20 to 85

Diaphragm pulse valve normally closed, 24 V DC (direct current), internal pilot control

Art. No.	Type No.	Thread	Operating pressure bar	Vent port	DN	A mm	B mm	Diaphragms	Medium temperature °C
199903	MV 4211-1 G	G 3/4	2 - 8.5	-	32	61.0	90.0	TPE	-15 to 85
199904	MV 4212-1 G	G 1	2 - 8.5	-	32	61.0	90.0	TPE	-15 to 85
199905	MV 4213-1 G	G 1 1/2	2 - 8.5	G 3/8	55	61.0	132.0	TPE	-15 to 85
102991	MV 4214 G	G 2	0.35 - 8.5	G 3/4	66	80.0	168.0	CR	-20 to 85
102992	MV 4215 G	G 2 1/2	0.35 - 8.5	G 3/4	66	80.0	168.0	CR	-20 to 85

Solenoid valves

stainless steel - 2/2-way type

Available versions

- Directly operated
- Combined operation

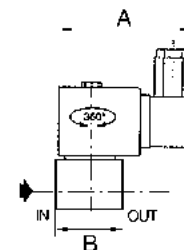

Housing	Stainless steel 1.4301
Valve seat	Stainless steel 1.4301
Internal parts	Stainless steel
Electrical connection	For Pg 11P connector socket acc. to DIN 4400
Protection IP	IP65 (with connector socket fitted)

Solenoid valve normally closed, 230 V, 50 to 60 Hz, directly operated

Art. No.	Type No.	Thread	Operating pressure bar	Medium temperature °C	DN	Sealant	A mm	B mm	Type
102969	MV 100 ES	NPT 1/8	0 - 25	-25 to 80	2.4	NBR	91.0	30.0	1
102970	MV 120 ES	NPT 1/8	0 - 25	-15 to 100	2.4	FPM	91.0	30.0	1
102971	MV 101 ES	G 1/4	0 - 14	-25 to 80	4	NBR	95.0	40.0	2
102972	MV 121 ES	G 1/4	0 - 14	-15 to 100	4	FPM	95.0	40.0	2



Bauform 1

Solenoid valve normally closed, 24 V DC (direct current), directly operated

Art. No.	Type No.	Thread	Operating pressure bar	Medium temperature °C	DN	Sealant	A mm	B mm	Type
102973	MV 100 ES-G	NPT 1/8	0 - 14	-25 to 80	2.4	NBR	91.0	30.0	1
102974	MV 120 ES-G	NPT 1/8	0 - 14	-15 to 120	2.4	FPM	91.0	30.0	1
102975	MV 101 ES-G	G 1/4	0 - 3.5	-25 to 80	4	NBR	95.0	40.0	2
102976	MV 121 ES-G	G 1/4	0 - 3.5	-15 to 120	4	FPM	95.0	40.0	2



Solenoid valve normally closed, 230 V, 50 to 60 Hz, combined operation

Art. No.	Type No.	Thread	Operating pressure bar	Medium temperature °C	DN	Sealant	A mm	B mm	Type
102977	MV 102 ES	G 1/2	0 - 9	-20 to 85	16	NBR	80.0	71.0	3
102978	MV 122 ES	G 1/2	0 - 9	-15 to 100	16	FPM	80.0	71.0	3
102979	MV 103 ES	G 3/4	0 - 9	-20 to 85	16	NBR	80.0	71.0	3



Bauform 3

Solenoid valve normally closed, 24 V DC (direct current), combined operation

Art. No.	Type No.	Thread	Operating pressure bar	Medium temperature °C	DN	Sealant	A mm	B mm	Type
102980	MV 102 ES-G	G 1/2	0 - 3	-20 to 85	16	NBR	80.0	71.0	3
102981	MV 122 ES-G	G 1/2	0 - 3	-15 to 100	16	FPM	80.0	71.0	3
102982	MV 103 ES-G	G 3/4	0 - 3	-20 to 85	16	NBR	80.0	71.0	3

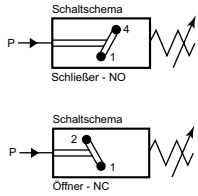

Pressure switches

standard type

EASY

For liquid, non-corrosive and gaseous media. Easy to adjust, even under pressure. Can be integrated in any mounting position. Pressure adjustment by means of a hexagon-head screw.

Material	Galvanised steel
Ambient temperature	-25 to 85 °C
Electrical connection	Tab connectors 2 x 6.3 x 0.8
Switching voltage	42 V
Switching frequency	200/min
Applications	Air, hydraulic oil, oil emulsions, water



DS 4015

Pressure switch, standard type

Art. No.	Type No.	Thread	Adjustment range bar	Function	Type of construction
102993	DS 4011	G 1/8	0.5 - 2	NO	Spring-loaded diaphragm (NBR)
102994	DS 4012	G 1/8	1 - 10	NO	Spring-loaded diaphragm (NBR)
102995	DS 4013	G 1/8	10 - 70	NO	Spring-loaded piston
102996	DS 4014	G 1/4	0.5 - 2	NO	Spring-loaded diaphragm (NBR)
102997	DS 4015	G 1/4	1 - 10	NO	Spring-loaded diaphragm (NBR)
102998	DS 4016	G 1/4	10 - 70	NO	Spring-loaded piston
102999	DS 4021	G 1/8	0.5 - 2	NC	Spring-loaded diaphragm (NBR)
103000	DS 4022	G 1/8	1 - 10	NC	Spring-loaded diaphragm (NBR)
103001	DS 4023	G 1/8	10 - 70	NC	Spring-loaded piston
103002	DS 4024	G 1/4	0.5 - 2	NC	Spring-loaded diaphragm (NBR)
103003	DS 4025	G 1/4	1 - 10	NC	Spring-loaded diaphragm (NBR)
103004	DS 4026	G 1/4	10 - 70	NC	Spring-loaded piston

→ Protective caps at page 345

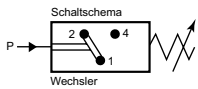

Pressure switches

changeover type

EASY

For liquid, non-corrosive and gaseous media. Easy to adjust, even under pressure. Can be integrated in any mounting position. Pressure adjustment by means of a hexagon-head screw.

Material	Galvanised steel
Ambient temperature	-25 to 85 °C
Electrical connection	Tab connectors 3 x 6.3 x 0.8
Switching frequency	200/min
Switching voltage	42 V
Function	changeover contact
Applications	Air, hydraulic oil, oil emulsions, water



DS 4034

Pressure switch, changeover type

Art. No.	Type No.	Thread	Adjustment range bar	Type of construction
103012	DS 4034	G 1/4	0.5 - 2	Spring-loaded diaphragm (NBR)
103013	DS 4035	G 1/4	1 - 10	Spring-loaded diaphragm (NBR)
103014	DS 4036	G 1/4	10 - 70	Spring-loaded piston

→ Protective caps at page 345

Pressure switches

changeover type, can be rotated 360°

EASY

For liquid, non-corrosive and gaseous media. Easy to adjust, even under pressure. Can be integrated in any mounting position. Pressure adjustment by means of a hexagon-head screw.

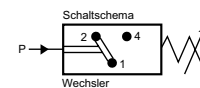

Material	Galvanised steel
Type of construction	Spring-loaded diaphragm (NBR)
Ambient temperature	-25 to 85 °C
Electrical connection	Coupling plug Pg 9, DIN 43650
Switching voltage	250 V
Switching frequency	200/min
Function	changeover contact
Applications	Air, hydraulic oil, oil emulsions, water

Pressure switch, changeover type, can be rotated 360°

Art. No.	Type No.	Thread	Adjustment range bar
103017	DS 6001	G 1/8	0.3 - 2
103018	DS 6002	G 1/8	1 - 10
103019	DS 6003	G 1/8	10 - 70
103020	DS 6011	G 1/4	0.3 - 2
103021	DS 6012	G 1/4	1 - 10
103022	DS 6013	G 1/4	10 - 70



DS 6012



Pressure switches

with bayonet coupling, changeover type

EASY

Special pressure switches for critical (water) or outdoor applications. Maximum degree of protection IP67 when a bayonet coupling is used for the electrical connection.

Material	Galvanised steel
Ambient temperature	-25 to 85 °C
Electrical connection	Bayonet coupling connector Ø 2.5 mm
Switching voltage	42 V
Switching frequency	200/min
Function	changeover contact

Pressure switch with bayonet coupling, changeover type

Art. No.	Type No.	Thread	Adjustment range bar	Type of construction
103023	DS 4601	G 1/8	0.5 - 2	Spring-loaded diaphragm (UR)
103024	DS 4602	G 1/8	1 - 10	Spring-loaded diaphragm (UR)
103025	DS 4603	G 1/8	10 - 70	Spring-loaded piston
103026	DS 4611	G 1/4	0.5 - 2	Spring-loaded diaphragm (UR)
103027	DS 4612	G 1/4	1 - 10	Spring-loaded diaphragm (UR)
103028	DS 4613	G 1/4	10 - 70	Spring-loaded piston



DS 4602

Accessories

Art. No.	Type No.	Description
103029	1920.DS46	Plug connector



Pressure switches

vacuum type

EASY

For liquid, non-corrosive and gaseous media. Easy to adjust, even under pressure. Can be integrated in any mounting position. Pressure adjustment by means of a hexagon-head screw.



DS 3001

Material	Brass
Type of construction	Spring-loaded diaphragm (NBR)
Ambient temperature	-25 to 85 °C
Adjustment range	20 - 800 mbar vacuum
Electrical connection	Tab connectors 3 x 6.3 x 0.8
Switching voltage	42 V
Switching frequency	200/min
Function	changeover contact
Applications	Air, hydraulic oil, oil emulsions, water

Pressure switch, vacuum type

Art. No.	Type No.	Thread
103011	DS 3001	G 1/8

→ Protective caps at page 345

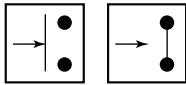

Schließer Öffner

Pressure switches

mini type

PLUS

For liquid, non-corrosive and gaseous media. Easy to adjust, even under pressure. Can be integrated in any mounting position. Pressure adjustment by means of a hexagon-head screw.



DS 214

Material	Brass
Type of construction	Spring-loaded diaphragm (NBR)
Ambient temperature	-25 to 85 °C
Electrical connection	Tab connectors 2 x 6.3 x 0.8
Switching voltage	42 V
Switching frequency	200/min
Applications	Air, hydraulic oil, oil emulsions, water

Pressure switch, mini type

Art. No.	Type No.	Thread	Function	Adjustment range bar
103015	DS 214	G 1/8	NO	1 - 10
103016	DS 215	G 1/8	NC	1 - 10

Pressure switches

for high precision at low pressures

PLUS

Economy series precision pressure switches for use in the low-pressure range (very low differential reset pressure: 5%).

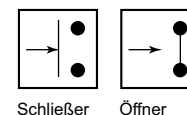

Schließer Öffner

Material	Brass
Type of construction	Spring-loaded diaphragm (NBR)
Ambient temperature	-25 to 85 °C
Electrical connection	Tab connectors 2 x 6.3 x 0.8
Switching voltage	42 V
Switching frequency	100/min
Applications	Air, oil emulsions, water

Pressure switch, for high precision at low pressures

Art. No.	Type No.	Thread	Function	Adjustment range bar
103071	DS 360	M10x1	NO	0.2 - 1.5
103072	DS 361	M10x1	NC	0.2 - 1.5



DS 360

Pressure switches

changeover type

PLUS

Special pressure switches for pneumatic applications. Extremely precise thanks to the large control diaphragm.

Type of construction	Spring-loaded diaphragm (NBR)
Ambient temperature	-25 to 85 °C
Electrical connection	Pg 11P coupling plug acc. to ISO 4400
Switching voltage	max. 250 V AC/DC
Switching frequency	60/min
Function	changeover contact
Applications	Air, neutral gases (lubricated or unlubricated)

Pressure switch, changeover type

Art. No.	Type No.	Thread	Material	Adjustment range bar
103005	DS 4801	G 1/4	Plastic (PA 61/XT)	0.2 - 6
103006	DS 4802	G 1/4	Plastic (PA 61/XT)	0.5 - 10
103007	DS 4803	G 1/4	Black anodised aluminium	0.5 - 16

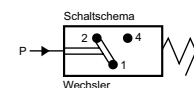

DS 4802



Pressure switches

changeover type, suitable for flange mounting

PLUS

Special pressure switches for pneumatic applications. Extremely precise thanks to the large control diaphragm. Two through holes in the housing for flanging the switch.

Material	Plastic (PA 61/XT)
Type of construction	Spring-loaded diaphragm (NBR)
Ambient temperature	-10 to 60 °C
Electrical connection	Pg 11P coupling plug acc. to ISO 4400
Switching voltage	max. 250 V AC/DC
Switching frequency	60 Zyklen/min.
Protection IP	IP 65
Function	changeover contact
Applications	Air, neutral gases (lubricated or unlubricated)



DS 9410

Pressure switch, changeover type, suitable for flange mounting

Art. No.	Type No.	Adjustment range bar
100280	DS 9410	0.5 - 10

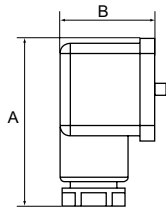
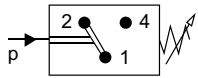
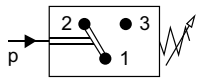

Pressure switches

PLUS

For converting pneumatic to electrical signals. Designed for use in rough vacuum applications (technical vacuum). Universal switch type, suitable as NC, NO or changeover contact. These devices are free from paint-wetting impairment substances (PWIS).

Housing	Special die-cast material
Adjusting knob	Aluminium, powder-coated
Diaphragms	NBR
Sealant	NBR
Temperature range	-20 to 80 °C
Switching frequency	200/min.
Protection IP	IP65 (DIN 43650), IP67 (M12x1)
Applications	Pneumatic applications

Pressure switches, electrical connection with plug connector, type A acc. to DIN 43650

Art. No.	Type No.	Connection	Adjustment range bar	Switching voltage	A mm	B mm
103030	DS 5811	G 1/4	0.2 - 2	250 V AC / 28 V DC	48.0	28.0
103031	DS 5812	G 1/4	0.5 - 8	250 V AC / 28 V DC	48.0	28.0
103032	DS 5813	G 1/4	1 - 16	250 V AC / 28 V DC	48.0	28.0



DS 5812

Pressure switches, electrical connection M12x1

Art. No.	Type No.	Connection	Adjustment range bar	Switching voltage	A mm	B mm
103033	DS 5821	G 1/4	0.2 - 2	48 V AC / 28 V DC	48.0	28.0
103034	DS 5822	G 1/4	0.5 - 8	48 V AC / 28 V DC	48.0	28.0
103035	DS 5823	G 1/4	1 - 16	48 V AC / 28 V DC	48.0	28.0



PVZ 11

Accessories

Art. No.	Type No.	Description
101635	PVZ 10	M12 angle cable socket, 5-pin, with screw terminals
101636	PVZ 11	Power supply cable 2 m, 5 x 0.25 mm ²

Hoods

For protecting the electrical connections.

Hood		
Art. No.	Type No.	Description
103008	DS 20	for pressure switch vacuum type
103009	DS 30	for pressure switch standard type and changeover type
103010	DS 40	for pressure switch mini type



DS 20

Pressure switches

for compressors, »MDR 2« type

PLUS

Version	Single-phase version
Switching capacity	2.2 kW
Max. cut-out pressure	12 bar
Contact type	NC (2-pole)
Medium temperature	-5 to 80 °C
Protection IP	IP 44
Switching frequency	max. 120 (electrical), 600 (mechanical)
Compressed air inlet	G 1/4

Pressure switch, with unloading valve, on/off switch, flange F4 1/4

Art. No.	Type No.	Adjustment range bar
103040	MDR 2/11	4 - 12



MDR 2/11

Accessories

Art. No.	Type No.	Description
103041	EV 2	Unloading valve
103042	H 2-EA	Hood with on/off switch
103043	M 200	Diaphragm



EV 2



H 2-EA



M 300



Pressure switches

for compressors, »MDR 3« type

PLUS

Version	Three-phase version
Switching capacity	7.5 kW
Max. cut-out pressure	12 bar
Contact type	NC (3-pole)
Medium temperature	-5 to 80 °C
Protection IP	IP 54
Switching frequency	max. 120 (electrical), 600 (mechanical)
Compressed air inlet	G 1/2

Pressure switch, without unloading valve, with on/off switch, without motor protection circuit, with flange F4 1/2

Art. No.	Type No.	Adjustment range bar
103044	MDR 3/11	4 - 11
103045	MDR 3/16	6 - 16



MDR 3/11-6,3

Pressure switch, with unloading valve, on/off switch, motor protection circuit and flange F4 1/2

Art. No.	Type No.	Adjustment range bar	Max. load A
103046	MDR 3/11-16	4 - 11	10.0 - 16.0
103047	MDR 3/11-6,3	4 - 11	4.0 - 6.3
103048	MDR 3/11-10	4 - 11	6.3 - 10.0
103049	MDR 3/16-6,3	6 - 16	4.0 - 6.3
103050	MDR 3/16-10	6 - 16	6.3 - 10.0



EV 3

R 3/10

H 3-EA

M 300

Accessories

Art. No.	Type No.	Description
103051	EV 3	Unloading valve
103052	R 3/16	Motor protection circuit (overcurrent relay) 10/16 A
103053	R 3/6,3	Motor protection circuit (overcurrent relay) 4/6.3 A
103054	R 3/10	Motor protection circuit (overcurrent relay) 6.3/10 A
103055	H 3-EA	Hood with on/off switch
103056	M 300	Diaphragm

Pressure switches

for compressors, »MDR 5« type

PLUS

Version	Three-phase version
Switching capacity	5.5 kW
Max. cut-out pressure	16 bar
Contact type	NC (3-pole)
Medium temperature	-5 to 80 °C
Protection IP	IP 54
Switching frequency	max. 120 (electrical), 600 (mechanical)
Compressed air inlet	G 1/2

Pressure switch, without unloading valve, on/off switch, motor protection circuit, with flange F4 1/2

Art. No.	Type No.	Adjustment range bar
103057	MDR 5/11	2 - 11
103058	MDR 5/16	2.5 - 16

Pressure switch, with unloading valve, on/off switch, flange F4 1/2, without motor protection circuit

Art. No.	Type No.	Adjustment range bar
103059	MDR 5/11K	2 - 11
103060	MDR 5/16K	2.5 - 16

→ Important
 A thermal, 3-pole overcurrent relay must be ordered together with these switches.
 Without this relay, the on/off mechanism does not work.

Accessories

Art. No.	Type No.	Description
103061	EV 5	Unloading valve
103062	R 5/2,4	Motor protection circuit (overcurrent relay) 1.50 - 2.45 A
103063	R 5/4,2	Motor protection circuit (overcurrent relay) 2.40 - 4.20 A
103064	R 5/7	Motor protection circuit (overcurrent relay) 4.00 - 7.00 A
103065	R 5/10,3	Motor protection circuit (overcurrent relay) 6.10 - 10.3 A
103066	R 5/14	Motor protection circuit (overcurrent relay) 9.00 - 14.0 A
103067	R 5/18	Motor protection circuit (overcurrent relay) 11.0 - 18.0 A
103068	M 500	Diaphragm
103069	H 5-K	Hood with on/off switch
103070	H 5	Hood without on/off switch



MDR 5/11



MDR 5/11K



EV 5



R 5/7



R 5/10,3



M 500



H 5-K



H 5

Electronic pressure switch

with digital display, 2-colour

PLUS

Electronic pressure switch with digital display in stable plastic housing for monitoring and measuring pressures in dry, oil-free compressed air and non-toxic, non-aggressive gasses.

Areas of application: Pneumatics, machine tools, compressors, automation technology and in general machine construction.

Output signal: 2 x digital NPN or PNP, 1 x analogue 1 – 5 V or 4 - 20 mA
Selectable units: MPa, kgf/cm², bar, psi

Hysteresis adjustable. Menu guided setting using three large buttons and easy to read 2-colour digital LCD display.
Installation location selectable.

Electrical connection	2 m cable, open cable ends
Ambient temperature	-10 to 60 °C
Medium temperature	0 to 50 °C
Measuring range	0 to 10 bar
Power supply	12 - 24 V DC ± 10 %
Housing	Plastic
Wetted parts	MSV
Process connection	G 1/8
Accuracy	±2 % F.S. ± 1 digit
Protection IP	IP 40 / IP 65 (with hose)



EDS010PNP15G

Electronic pressure switch with digital display

Art. No.	Type No.	Output signal
133157	EDS010NPN15G	2 x NPN outputs + 1 x analog output 1 - 5 V
133158	EDS010NPN420G	2 x NPN outputs + 1 x analog output 4 - 20 mA



EDS010-BFWW EDS010-BFWS

Accessoires for electronic pressure switch with digital display

Art. No.	Type No.	Description
133153	EDS010-BFWW	Metal mounting bracket, horizontal
133154	EDS010-BFWS	Metal mounting bracket, vertical
133155	EDS010-EBR	Plastic installation frame
133156	EDS010-EBRSA	Installation frame with plastic protective cover



EDS010-EBR EDS010-EBRSA

Electronic pressure switch

with digital display

MAX

Electronic pressure switch with digital display, made of stainless steel, for monitoring and measuring pressures in liquids, gases or compressed air.

Applications: Machine tools, compressors and pumps, hydraulic and pneumatic systems, machinery in general, factory automation.

Customisable switching functions: Switching / switch-back point or window function, switching delay times, NO and NC functions, min. / max. memory. Password protection for maximum security.

The display and case can be turned 300° for mounting in any position.

Three large keys for intuitive operation with an easy-to-read display conforming to VDMA Standard 24574-1.

Optional on request: Pressure switch with additional analog signal 4 - 20 mA, DC 0 - 10 V and 5-pin plug.

Electrical connection	circular plug-in connector M12 x 1, 4-pin
Output signal	2 switching outputs
Ambient temperature	-20 to 80 °C
Medium temperature	-20 to 85 °C
Power supply	DC 15 - 35 V
Housing	CrNi steel
Wetted parts	CrNi steel
Process connection	G 1/4
Accuracy	1% of span
Protection IP	IP 65 and IP 67 (M12x1)



Electronic pressure switch with digital display

Art. No.	Type No.	Connection	Measuring range bar
103073	EDS-1	G 1/4	0 to 1
103074	EDS-2	G 1/4	0 to 2,5
103075	EDS-4	G 1/4	0 to 4
103076	EDS-6	G 1/4	0 to 6
103077	EDS-10	G 1/4	0 to 10
103078	EDS-16	G 1/4	0 to 16
103079	EDS-25	G 1/4	0 to 25
103080	EDS-40	G 1/4	0 to 40
103081	EDS-60	G 1/4	0 to 60
103082	EDS-100	G 1/4	0 to 100
103083	EDS-160	G 1/4	0 to 160
103084	EDS-250	G 1/4	0 to 250
103085	EDS-400	G 1/4	0 to 400
103086	EDS-600	G 1/4	0 to 600



EDS-1

Connector and cable with plug, suitable for electronic pressure switch

Art. No.	Type No.	Description
103087	EDS-SG	Straight connector, 4-pole, without cable
103088	EDS-SW	Angular connector, 4-pole, without cable
103089	EDS-KG2	Straight connector, 4-pole, with 2 m PUR cable
103090	EDS-KG5	Straight connector, 4-pole, with 5 m PUR cable
103091	EDS-KW2	Angular connector, 4-pole, with 2 m PUR cable
103092	EDS-KW5	Angular connector, 4-pole, with 5 m PUR cable



EDS-SG

EDS-SW



EDS-KW2

EDS-KG2

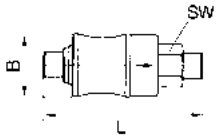
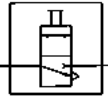

Manual slide valves

EASY

For use on devices that have to be vented whenever they are turned off, either because of safety regulations or for technical reasons. The pneumatic devices are disconnected from the system and simultaneously vented each time they are shut off.

Max. operating pressure 10 bar
Operating temperature 0 to 70 °C



3214.72



215.72*

Manual slide valve

Art. No.	Type No.	Thread	a/f mm	B mm	L mm
103759	3214.71	G 1/8 ET	14	21.0	67.0
103760	3214.72	G 1/4 ET	17	24.0	77.0
103761	3214.73	G 3/8 ET	22	31.0	87.0
103762	3214.74	G 1/2 ET	26	35.0	104.0
117404	215.71*	G 1/8 IT	14	21.0	46.0
117405	215.72*	G 1/4 IT	17	24.0	51.5
117406	215.73*	G 3/8 IT	22	31.0	59.0
117407	215.74*	G 1/2 IT	26	35.0	72.5

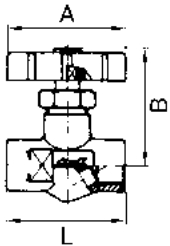

Needle valves

EASY

Material Brass
Stem With fine adjustment
Wheel Plastic
Max. operating pressure 16 bar
Operating temperature -30 to 110 °C
Sealant NBR
DN 4



213.40

Needle valve, male thread with inside cone or female thread

Art. No.	Type No.	Thread	a/f mm	A mm	B mm	L mm
103763	213.40	G 1/4 ET	17	48.0	50.0	45.0
103764	213.41	G 3/8 ET	22	48.0	54.0	51.0
103765	210.80	G 1/4 IT	17	48.0	48.0	42.0
103766	210.81	G 3/8 IT	22	48.0	52.0	51.0
103767	210.82	G 1/2 IT	27	48.0	56.0	64.0

Angle-type globe valves

PLUS

Material	Brass
Stem	With stainless steel ball
Wheel	Plastic
Max. operating pressure	40 bar
Operating temperature	-10 to 80 °C

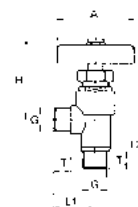

Globe valve, male thread, with inside cone for ball-type hose fitting

Art. No.	Type No.	Thread	DN	a/f mm	A mm	H mm	L1 mm	L2 mm	T mm
103721	211.11	G 1/4	5.5	22	48.0	53.0	29.0	25.0	11.0
103722	211.22	G 3/8	8	19	48.0	55.0	29.0	22.5	11.0



211.22

Globe valves

PLUS

Material	Brass
Stem	With stainless steel ball
Wheel	Plastic
Max. operating pressure	40 bar
Operating temperature	-10 to 80 °C

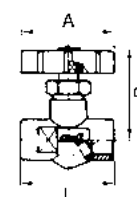

Globe valve, male thread, with inside cone for ball-type hose fitting

Art. No.	Type No.	Thread	DN	a/f mm	A mm	B mm	L mm
103718	213.11	G 1/4	5.5	17	48.0	50.0	42.0
103719	213.22	G 3/8	8	22	48.0	55.0	52.0
103720	213.33	G 1/2	11	27	48.0	65.0	67.0



213.11

Drain and vent valves

PLUS

Material	Brass
Max. operating pressure	25 bar
Operating temperature	0 to 90 °C

Drain valve angle type, with hose fitting (for hose I.D 12 mm) and knurled screw

Art. No.	Type No.	Thread	Length mm	Sealant
103739	223.10	G 1/8	43.5	NBR
103740	223.20	G 1/4	43.5	NBR



223.20

Drain valve, straight type, with knurled screw

Art. No.	Type No.	Thread	Length mm
103741	224.00	G 1/8	21.0
103742	224.01	G 1/4	25.0



224.01

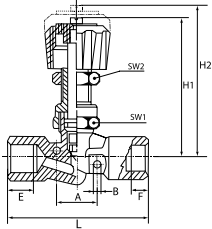

Needle valves

PLUS

Housing	Nickel-plated brass
Stem	Brass
Wheel	Plastic
Sealant	NBR
Max. operating pressure	18 bar
Operating temperature	-10 to 80 °C
Standard thread	Rp thread and R thread acc. to ISO 7/1



210.80-N

Needle valve, female/female thread

Art. No.	Type No.	Thread	A mm	B mm	L mm	E mm	F mm	H1 mm	H2 mm	a/f 1 mm
136226	210.79-N	Rp 1/8	20.5	4.5	51.6	6.7	6.7	38.2	42.8	19
136227	210.80-N	Rp 1/4	20.5	4.5	57.0	8.0	8.0	38.2	42.8	19
136228	210.81-N	Rp 3/8	21.0	4.5	63.0	10.0	10.0	52.7	59.9	21
136229	210.82-N	Rp 1/2	21.0	4.5	69.0	11.0	11.0	52.7	59.9	21



210.90-N

Needle valve, female/female thread, with bulkhead fitting for panel mounting

Art. No.	Type No.	Thread	A mm	B mm	L mm	E mm	F mm	H1 mm	H2 mm	a/f 1 mm	a/f 2 mm
136230	210.89-N	Rp 1/8	20.5	4.5	51.6	6.7	6.7	51.0	56.0	19	17
136231	210.90-N	Rp 1/4	20.5	4.5	57.0	8.0	8.0	51.0	56.0	19	17
136232	210.91-N	Rp 3/8	21.0	4.5	63.0	10.0	10.0	70.2	77.4	21	17
136233	210.92-N	Rp 1/2	21.0	4.5	69.0	11.0	11.0	70.2	77.4	21	17



212.40-N

Needle valve, female/male thread

Art. No.	Type No.	Thread	A mm	B mm	L mm	E mm	F mm	H1 mm	H2 mm	a/f 1 mm
136234	212.39-N	Rp/R 1/8	20.5	4.5	52.3	6.7	8.5	38.2	42.8	19
136235	212.40-N	Rp/R 1/4	20.5	4.5	53.0	8.0	8.5	38.2	42.8	19
136236	212.41-N	Rp/R 3/8	21.0	4.5	56.5	10.0	9.0	52.7	59.9	21
136237	212.42-N	Rp/R 1/2	21.0	4.5	63.5	11.0	11.0	52.7	59.9	21



213.40-N

Needle valve, male/male thread

Art. No.	Type No.	Thread	A mm	B mm	L mm	E mm	F mm	H1 mm	H2 mm	a/f 1 mm
136238	213.39-N	R 1/8	20.5	4.5	53.0	8.5	8.5	38.2	42.8	19
136239	213.40-N	R 1/4	20.5	4.5	49.0	8.5	8.5	38.2	42.8	19
136240	213.41-N	R 3/8	21.0	4.5	52.0	9.0	9.0	52.7	59.9	19
136241	213.42-N	R 1/2	21.0	4.5	58.0	11.0	11.0	52.7	59.9	21

Bidirectional flow control valves

in block design

MAX

Straight-way valves with restricted flow in both directions.

Housing	Anodized aluminium
Internal parts	Brass
Sealant	NBR
Max. operating pressure	10 bar
Operating temperature	-10 to 70 °C

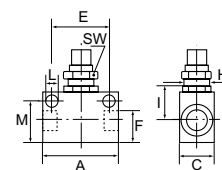
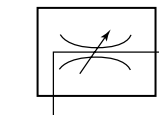

Bidirectional flow control valve

Art. No.	Type No.	Thread	A mm	C mm	E mm	I mm	L mm	M mm	a/f mm	Thread for panel mounting
103809	225.53	G 1/8	34.0	16.0	24.0	15.0	4.5	16.4	15	M12x0.75
103810	225.54	G 1/4	50.0	25.0	35.0	24.0	6.5	23.8	22	M18x1.5
103811	225.55	G 3/8	58.0	25.0	40.0	24.0	6.5	25.3	22	M18x1.5
103812	225.56	G 1/2	65.0	30.0	50.0	29.0	6.5	33.0	26	M22x1.5



225.54

Unidirectional flow control valves

in block design

MAX

These valves are restricted in the flow direction and have free passage in the opposite direction.

Housing	Anodized aluminium
Internal parts	Brass
Sealant	NBR
Max. operating pressure	10 bar
Operating temperature	-10 to 70 °C

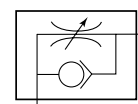

Unidirectional flow control valve

Art. No.	Type No.	Thread	A mm	C mm	E mm	I mm	L mm	M mm	a/f mm	Thread for panel mounting
103802	225.32	M5	25.0	12.0	18.0	10.0	3.2	12.2	11	M9x0.75
103803	225.33	G 1/8	34.0	16.0	24.0	15.0	4.5	16.4	15	M12x0.75
103804	225.34	G 1/4	50.0	25.0	35.0	24.0	6.5	23.8	22	M18x1.5
103805	225.35	G 3/8	58.0	25.0	40.0	24.0	6.5	25.3	22	M18x1.5
103806	225.36	G 1/2	65.0	30.0	50.0	29.0	6.5	33.0	26	M22x1.5



225.34

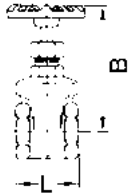

Female thread globe valves

Brass



Max. operating pressure	10 bar
Operating temperature	-10 to 80 °C
Housing	Brass
Bonnet	Brass
Applications	Non-corrosive liquids and steam up to 90 °C
Sealant	NBR



250.52

Female thread globe valve, brass body

Art. No.	Type No.	Thread	DN	L mm	B mm
103789	250.51	G 1/2	15	54.0	78.0
103790	250.52	G 3/4	20	54.5	78.0
103791	250.53	G 1	25	61.0	82.0
103792	250.54	G 1 1/4	32	88.5	126.0
103793	250.55	G 1 1/2	40	101.0	128.0
103794	250.56	G 2	50	117.0	149.0



Female thread gate valves



Opening / closing without stem stroke

Max. operating pressure	16 bar
Housing	Brass
Stem	Brass
Wheel	Aluminium
Applications	Non-corrosive liquids, gases and steam up to 120 °C



250.35

Female thread gate valve, brass body

Art. No.	Type No.	Thread	DN	L mm	B mm
103774	250.33	G 3/8	10	41.0	86.0
103775	250.34	G 1/2	15	42.5	88.0
103776	250.35	G 3/4	20	49.0	101.2
103777	250.36	G 1	25	54.5	117.5
103778	250.37	G 1 1/4	32	58.0	133.0
103779	250.38	G 1 1/2	40	61.0	152.5
103780	250.39	G 2	50	69.0	177.3
103781	250.40	G 2 1/2	60	88.0	219.0
103782	250.41	G 3	70	97.0	261.0

Needle valves

Material	Stainless steel 1.4571
Sealant	PTFE
Wheel	Plastic
Operating temperature	-20 to 120 °C



Needle valve, stainless steel

Art. No.	Type No.	Thread	DN	Max. operating pressure at 20 °C bar	A mm	C mm	L mm
103768	240.81 ES	G 1/8	4	400	50.0	74.0	50.0
103769	240.82 ES	G 1/4	5	400	50.0	73.0	50.0
103770	240.83 ES	G 3/8	6	400	50.0	72.0	55.0
103771	240.84 ES	G 1/2	8	400	63.0	83.0	60.0
103772	240.85 ES	G 3/4	10	400	63.0	100.0	75.0
103773	240.86 ES	G 1	12	250	80.0	110.0	100.0



240.84 ES

→ Port sizes G 1 1/4, G 1 1/2 and G 2 available on request

Bidirectional flow control valves

block design, stainless steel 1.4404

Straight-way valve with restricted flow in both directions.

Housing	Stainless steel 1.4404
Internal parts	Stainless steel 1.4404
Sealant	FPM
Max. operating pressure	10 bar
Operating temperature	0 to 150 °C

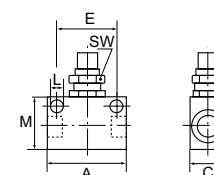
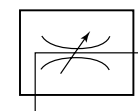

Bidirectional flow control valves, stainless steel

Art. No.	Type No.	Thread	A mm	C mm	E mm	L mm	M mm	a/f mm
103813	ES 225.53	G 1/8	34.0	15.0	24.0	4.5	20.0	14
103814	ES 225.54	G 1/4	50.0	25.0	35.0	5.5	30.0	22



ES 225.54

Unidirectional flow control valves

in block design, stainless steel 1.4404

Unidirectional flow control valve, restricted in the flow direction and free passage in the opposite direction.

Housing	Stainless steel 1.4404
Internal parts	Stainless steel 1.4404
Sealant	FPM
Max. operating pressure	10 bar
Operating temperature	0 to 150 °C

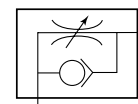

Unidirectional flow control valve, Edelstahl

Art. No.	Type No.	Thread	A mm	C mm	E mm	L mm	M mm	a/f mm
103807	ES 225.33	G 1/8	34.0	15.0	24.0	4.5	20.0	14
103808	ES 225.34	G 1/4	50.0	25.0	35.0	5.5	30.0	22



ES 225.34

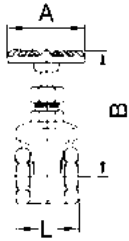

Female thread globe valves

stainless steel

Housing	Stainless steel 1.4401 / 1.4408
Internal parts	Stainless steel 1.4401 / 1.4408
Wheel	Aluminium
Sealant	PTFE
Max. operating pressure	14 bar
Max. medium temperature	160 °C
Max. ambient temperature	160 °C
Operating temperature	-10 to 180 °C



250.52 ES

Female thread globe valve, stainless steel

Art. No.	Type No.	Thread	DN	L mm	A mm	B min. mm	B max. mm
103795	250.50 ES	G 3/8	10	52.0	70.0	89.0	99.0
103796	250.51 ES	G 1/2	15	52.0	70.0	89.0	99.0
103797	250.52 ES	G 3/4	20	66.0	80.0	95.0	107.0
103798	250.53 ES	G 1	25	76.0	80.0	102.0	118.0
103799	250.54 ES	G 1 1/4	32	86.0	90.0	130.0	150.0
103800	250.55 ES	G 1 1/2	40	94.0	90.0	132.0	142.0
103801	250.56 ES	G 2	50	118.0	100.0	154.0	167.0

Female thread gate valves

stainless steel

Housing	Stainless steel 1.4401 / 1.4408
Internal parts	Stainless steel 1.4401 / 1.4408
Wheel	Aluminium
Sealant	PTFE
Max. operating pressure	14 bar
Max. medium temperature	160 °C
Max. ambient temperature	160 °C



250.35 ES

Female thread gate valve, stainless steel

Art. No.	Type No.	Thread	DN	L mm	A mm	B mm
103783	250.34 ES	G 1/2	15	55.0	70.0	100.0
103784	250.35 ES	G 3/4	20	60.0	70.0	107.0
103785	250.36 ES	G 1	25	65.0	80.0	110.0
103786	250.37 ES	G 1 1/4	32	75.0	80.0	130.0
103787	250.38 ES	G 1 1/2	40	85.0	90.0	147.0
103788	250.39 ES	G 2	50	95.0	100.0	170.0

Unidirectional valves

straight-way type, full passage

EASY

Housing	Brass
Valve disc	Stainless steel
Sealant	NBR
Pin	Brass
Spring	Stainless steel
Min. opening pressure	0,01 - 0,03 bar
Operating temperature	-20 to 100 °C
Standard thread	G thread acc. to DIN EN ISO 228-1

Unidirectional valve					
Art. No.	Type No.	Thread	Max. operating pressure bar	a/f mm	Length mm
103881	9227.31	G 3/8	25	23	55.0
103882	9227.32	G 1/2	25	27	58.5
103883	9227.33	G 3/4	25	33	65.0
103884	9227.34	G 1	25	40	74.5
103885	9227.35	G 1 1/4	18	50	83.0
103886	9227.36	G 1 1/2	18	55	93.0
103887	9227.37	G 2	18	70	101.0
134874	9227.38	G 2 1/2	12	87	122.0
134875	9227.39	G 3	12	101	141.5



9227.32



Unidirectional valves

straight-way type, compact series

EASY

Material	Nickel-plated brass
Sealant	NBR
Max. operating pressure	10 bar
Operating temperature	-10 to 70 °C
Max. medium temperature	70 °C
Max. ambient temperature	70 °C

Unidirectional valve					
Art. No.	Type No.	Thread	Min. opening pressure bar	a/f mm	Length mm
103840	228.00	M5	0.2	8	25.0
103841	228.01	G 1/8	0.2	13	36.5
103842	228.02	G 1/4	0.2	16	42.5
103843	228.03	G 3/8	0.2	20	51.0
103844	228.04	G 1/2	0.2	24	62.0



228.02

Unidirectional valve, mini series					
Art. No.	Type No.	Thread	Min. opening pressure bar	a/f mm	Length mm
103845	228.11	R/Rp 1/8	0,15	14	26.0
103846	228.22	R/Rp 1/4	0,35	17	32.0



228.22

Unidirectional valves

straight-way type

PLUS

Housing	Brass
Sealant	FKM
Max. operating pressure	40 bar



227.05



227.12

Unidirectional valves

Art. No.	Type No.	Thread	Min. opening pressure bar	Operating temperature °C	Medium temperature °C	a/f mm	Length mm
103815	227.01	G 1/4 IT	0,2 - 0,4	-	-18 to 160	19	53.0
103816	227.02	G 3/8 IT	0,2 - 0,4	-	-18 to 160	19	54.0
103817	227.03	G 1/2 IT	0,2 - 0,4	-	-18 to 160	24	63.0
103818	227.04	G 3/4 IT	0,1	-10 to 180	-	36	58.0
103819	227.05	G 1 IT	0,1	-10 to 180	-	46	68.5
103820	227.10	G 1/4 ET	0,2 - 0,4	-	-18 to 160	19	53.5
103821	227.11	G 3/8 ET	0,2 - 0,4	-	-18 to 160	19	54.0
103822	227.12	G 1/2 ET	0,2 - 0,4	-	-18 to 160	24	66.0
103823	227.13	G 3/4 ET	0,1	-10 to 180	-	36	77.0
103824	227.14	G 1 ET	0,1	-10 to 180	-	46	84.0

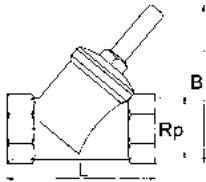

Unidirectional valves

angle-seat type, brass



Housing	Brass
Sealant	NBR
Min. opening pressure	0.5 bar
Max. operating pressure	10 bar
Max. medium temperature	80 °C
Max. ambient temperature	80 °C
Operating temperature	-30 to 90 °C
Medium	Water
Standard thread	Rp thread acc. to DIN 2999



220.05

Unidirectional valve

Art. No.	Type No.	Thread	a/f mm	B mm	L mm
103825	220.02	Rp 3/8	27	50.0	55.0
103826	220.03	Rp 1/2	27	50.0	59.0
103827	220.04	Rp 3/4	32	60.0	67.0
103828	220.05	Rp 1	38	71.0	83.0
103829	220.06	Rp 1 1/4	48	97.0	96.0
103830	220.07	Rp 1 1/2	54	114.0	106.0
103831	220.08	Rp 2	68	135.0	130.0

Unidirectional valves

angle-seat type, stainless steel

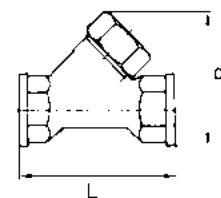

Housing	Stainless steel 1.4401 / 1.4408
Internal parts	Stainless steel 1.4401 / 1.4408
Sealant	FKM
Min. opening pressure	0.2 bar
Max. operating pressure	40 bar
Max. medium temperature	230 °C
Max. ambient temperature	230 °C
Operating temperature	-10 to 230 °C
Standard thread	G thread acc. to DIN EN ISO 228-1

Unidirectional valve

Art. No.	Type No.	Thread	a/f mm	B mm	L mm
103832	220.01-ES	G 1/4	27	53.5	66.0
103833	220.02-ES	G 3/8	27	53.5	66.0
103834	220.03-ES	G 1/2	27	53.5	66.0
103835	220.04-ES	G 3/4	32	68.0	76.0
103836	220.05-ES	G 1	40	82.0	90.0
103837	220.06-ES	G 1 1/4	50	97.0	110.0
103838	220.07-ES	G 1 1/2	55	113.0	121.0
103839	220.08-ES	G 2	70	131.0	151.0



220.05-ES



Non-return valves

straight-way type stainless steel

Housing	Stainless steel 1.4404
Spring	Stainless steel 1.4319
Sealant	FPM
Min. opening pressure	0.2 bar
Max. operating pressure	10 bar
Operating temperature	-10 to 150 °C

Non-return valve, stainless steel

Art. No.	Type No.	Thread	a/f mm	Length mm
103847	228.01-ES	G 1/8	13	40.0
103848	228.02-ES	G 1/4	16	48.0



228.01-ES

Check valve

Straight-way type, lightweight series, stainless steel

Stainless steel check valve with full bore and very low opening pressure, no maintenance required.
Applications: Compressed air, water, neutral gases, gaseous and liquid non-corrosive media, oils.

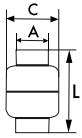

228.14-ES

Housing	Stainless steel 1.4301
Spring	Stainless steel 1.4301
Sealant	FKM
Min. opening pressure	0.03 bar
Max. operating pressure	16 bar
Operating temperature	-20 to 150 °C

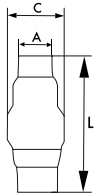

228.34-ES

Check valve, stainless steel, lightweight series, PN 16

Art. No.	Type No.	Thread	A mm	L mm	C mm
103849	228.14-ES	G 1/4	20.0	55.9	32.0
103850	228.38-ES	G 3/8	20.0	56.0	32.0
103851	228.12-ES	G 1/2	25.0	55.6	32.0
103852	228.34-ES	G 3/4	29.0	66.7	44.0
103853	228.10-ES	G 1	36.0	83.6	53.0
103854	228.114-ES	G 1 1/4	45.0	96.0	62.0
103855	228.112-ES	G 1 1/2	51.0	114.0	78.0
103856	228.20-ES	G 2	64.0	120.5	89.0

Strainers for check valves

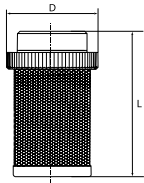

SKR-1-K

Filter	Stainless steel 1.4301
Thread material	Plastic
Operating temperature	-20 to 100 °C

Strainer with plastic thread

Art. No.	Type No.	Thread	L mm	D mm	Mesh size mm
134045	SKR-38-K	G 3/8	42.0	25.5	1.2
134046	SKR-12-K	G 1/2	47.0	29.5	1.2
134047	SKR-34-K	G 3/4	57.5	36.0	1.2
134048	SKR-1-K	G 1	69.0	43.5	1.2
134049	SKR-114-K	G 1 1/4	75.0	50.5	1.2
134050	SKR-112-K	G 1 1/2	83.0	56.5	1.2
134051	SKR-2-K	G 2	98.0	69.0	1.2
134052	SKR-212-K	G 2 1/2	123.0	86.0	2
134053	SKR-3-K	G 3	138.0	102.0	2

Strainers for check valves

Corrosion resistant screw-in strainer, all stainless steel, to suit foot-operated or check valves.

Housing	Stainless steel 1.4301
Filter	Stainless steel 1.4301
Max. temperature range	150 °C

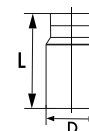

Strainer, stainless steel

Art. No.	Type No.	Thread	L mm	D mm	Mesh size mm
103859	SKR-38	G 3/8	55.0	19.0	1
103860	SKR-12	G 1/2	55.0	22.0	1
103861	SKR-34	G 3/4	62.0	29.0	1
103862	SKR-1	G 1	71.0	36.0	1
103863	SKR-114	G 1 1/4	80.0	43.0	1
103864	SKR-112	G 1 1/2	90.0	49.0	1
103865	SKR-2	G 2	101.0	60.0	1



SKR-38



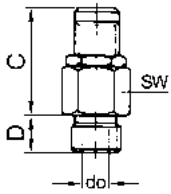

Mini-blow-off valves

brass, not type-tested

EASY

Manual adjustment of the blow-off pressure (lock nut).

For compressed air and non-toxic, non-flammable gases, cannot be used for liquids due to free blow-off, not suitable for steam.

Operating pressure	0.5 - 60 bar
Operating temperature	-20 to 180 °C
Sealant	FKM



218.11

Mini-blow-off valve brass, G 1/8

Art. No.	Type No.	Thread	Set pressure bar	Max. blow-off rate l/min	C mm	D mm	a/f mm	do mm
103901	218.10	G 1/8	0.5 - 1	50	27.0	7.0	16	3.0
103902	218.11	G 1/8	1 - 4	200	27.0	7.0	16	3.0
103903	218.12	G 1/8	3 - 7	350	27.0	7.0	16	3.0
103904	218.13	G 1/8	6 - 12	650	27.0	7.0	16	3.0
103905	218.14	G 1/8	10 - 18	870	27.0	7.0	16	3.0
103906	218.15	G 1/8	16 - 32	1600	27.0	7.0	16	3.0
103907	218.16	G 1/8	30 - 60	3000	27.0	7.0	16	3.0

Mini-blow-off valve brass, G 1/4

Art. No.	Type No.	Thread	Set pressure bar	Max. blow-off rate l/min	C mm	D mm	a/f mm	do mm
103908	218.20	G 1/4	0.5 - 1	50	27.0	7.0	16	3.0
103909	218.21	G 1/4	1 - 4	200	27.0	7.0	16	3.0
103910	218.22	G 1/4	3 - 7	350	27.0	7.0	16	3.0
103911	218.23	G 1/4	6 - 12	650	27.0	7.0	16	3.0
103912	218.24	G 1/4	10 - 18	870	27.0	7.0	16	3.0
103913	218.25	G 1/4	16 - 32	1600	27.0	7.0	16	3.0
103914	218.26	G 1/4	30 - 60	3000	27.0	7.0	16	3.0

Safety valves DN 8

PLUS

For compressed air and non-toxic, non-flammable gases, cannot be used for liquids due to free blow-off, not suitable for steam.

These valves are TÜV approved and have a TÜV type test number.

Operating pressure	0.2 - 50 bar
Operating temperature	-25 to 180 °C
Housing	Brass
Pressure spring	Stainless steel
Sealant	FKM

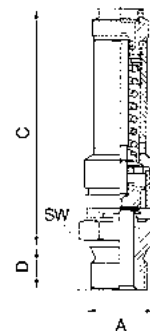

Safety valve DN 8

Type No.	Thread	Set pressure bar	a/f mm	A mm	C mm	D mm
226.01	G 1/4	0.2 - 14.2	20	18.0	63.0	10.0
		14.3 - 40.0	20	18.0	75.0	10.0
		40.1 - 50.0	20	18.0	82.0	10.0
226.02	G 3/8	0.2 - 14.2	20	20.0	63.0	12.0
		14.3 - 40.0	20	20.0	75.0	12.0
		40.1 - 50.0	20	20.0	82.0	12.0
226.03	G 1/2	0.2 - 14.2	24	24.0	63.0	14.0
		14.3 - 40.0	24	24.0	75.0	14.0
		40.1 - 50.0	24	24.0	82.0	14.0

→ Important ordering information:

These valves are type-tested and are only allowed to be delivered with a sealed lead disc. Please indicate the required set pressure in all orders.

→ Order example:

Safety valve G 3/8, set pressure 8.5 bar: Art. No. 226.02-8,5

→ Special versions and certificates acc. to DIN EN 10204 available on request.



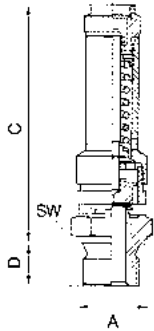

Safety valves DN 10

PLUS

For compressed air and non-toxic, non-flammable gases, cannot be used for liquids due to free blow-off, not suitable for steam.
These valves are TÜV approved and have a TÜV type test number.

Operating pressure	0.2 - 50 bar
Operating temperature	-25 to 180 °C
Housing	Brass
Pressure spring	Stainless steel
Sealant	FKM



Safety valve DN 10

Type No.	Thread	Set pressure bar	a/f mm	A mm	C mm	D mm
227.44	G 3/8	0.2 - 8.5	27	22.0	75.0	12.0
		8.6 - 40.0	27	22.0	95.0	12.0
		40.1 - 50.0	27	22.0	120.0	12.0
227.55	G 1/2	0.2 - 8.5	27	26.0	75.0	14.0
		8.6 - 40.0	27	26.0	95.0	14.0
		40.1 - 50.0	27	26.0	120.0	14.0
227.66	G 3/4	0.2 - 8.5	32	32.0	75.0	16.0
		8.6 - 40.0	32	32.0	95.0	16.0
		40.1 - 50.0	32	32.0	120.0	16.0

- Important ordering information:
These valves are type-tested and are only allowed to be delivered with a sealed lead disc.
Please indicate the required set pressure in all orders.
- Order example:
Safety valve G 3/4, set pressure 5.0 bar: Art. No. 227.66-5,0
- Special versions and certificates acc. to DIN EN 10204 available on request.

Safety valves

high-pressure type with high blow-off rate

MAX

For compressed air and non-toxic, non-flammable gases, cannot be used for liquids due to free blow-off, not suitable for steam.

These valves are TÜV approved and have a TÜV type test number.

Operating pressure	0.5 - 26 bar
Operating temperature	-40 to 200 °C
Housing	Brass
Pressure spring	C steel
Sealant	FPM

Safety valve, high-pressure type

Type No.	Thread	Set pressure bar	a/f mm	H mm	A mm	do mm
229.01	G 1/2	0.5 - 25.0	27	93.0	14.0	12.0
229.02	G 3/4	0.5 - 22.0	32	110.0	16.0	15.0
229.03	G 1	0.5 - 26.0	41	132.0	18.0	20.0
229.04	G 1 1/4	0.5 - 22.0	50	152.0	20.0	25.0
229.05	G 1 1/2	0.5 - 16.0	55	178.0	22.0	32.0
229.06	G 2	0.5 - 12.0	70	203.0	25.0	40.0

- Important ordering information:
These valves are type-tested and are only allowed to be delivered with a fixed setting. Please indicate the required set pressure in all orders.
- Order example:
Safety valve G 1, set pressure 12.5 bar: Art. No. 229.03-12,5
- Special versions and certificates acc. to DIN EN 10204 available on request.

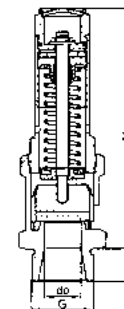

Angle-type safety valves

for air, similar gases, steam and saturated steam



Type-tested, TÜV – SV. 749 D/G

Adjustment range	0.2 - 20 bar (depending on size and medium)
Operating temperature	-10 °C to 150 °C (EPDM) 185 °C (PTFE)
Housing	Bronze
Spring bonnet	Brass
Internal parts	Brass
Spring	C steel
Diaphragms	EPDM (up to 3.5 bar PFFE)
Inlet and outlet	Each with female thread type G acc. to DIN EN ISO 228-1

Angle-type safety valve for saturated steam

Type No.	Thread	a/f mm	L1 mm	L2 mm	H mm
222.03	G 1/2	27	25.0	22.0	99.0
222.04	G 3/4	32	30.0	25.0	111.0
222.05	G 1	41	36.0	30.0	132.0
222.06	G 1 1/4	50	40.0	35.0	152.0
222.07	G 1 1/2	58	48.0	40.0	175.0
222.08	G 2	70	56.0	48.0	200.0

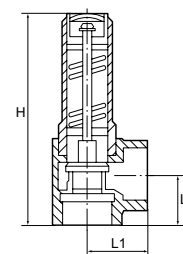

- Important ordering information:
The valves are type-tested and are only allowed to be delivered with a fixed setting. Please indicate the required set pressure in all orders.
- Order example:
Angle-type safety valve G 3/4, set pressure 2.0 bar: Art. No. 222.04-2,0
- Special versions and certificates acc. to DIN EN 10204 available on request.

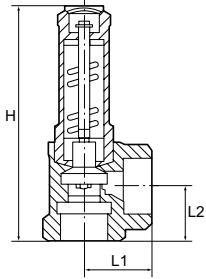

Angle-type safety valves

for liquids



For non-toxic, non-flammable liquids.
No evaporation allowed when blowing off.
With diaphragm to protect the spring and with lifting device.
Type-tested, TÜV-SV. 749. F

Adjustment range	1 - 16 bar (depending on the seal)
Operating temperature	-10 to 110 °C
Housing	Bronze
Spring bonnet	Brass
Internal parts	Brass
Diaphragms	NBR (up to 10 bar FPM)
Spring	C steel
Inlet and outlet	Each with female thread type G acc. to DIN EN ISO 228-1



Angle-type safety valve for liquids

Type No.	Thread	a/f mm	L1 mm	L2 mm	H mm
221.03	G 1/2	27	25.0	20.0	92.0
221.04	G 3/4	32	30.0	25.0	111.0
221.05	G 1	41	36.0	30.0	132.0
221.06	G 1 1/4	50	40.0	35.0	152.0
221.07	G 1 1/2	58	48.0	40.0	175.0
221.08	G 2	70	56.0	48.0	200.0

- Important ordering information:
These valves are type-tested and are only allowed to be delivered with a fixed setting.
Please indicate the required set pressure in all orders.
- Order example:
Angle-type safety valve G 1, set pressure 5.0 bar: Art. No. 221.05-5,0
- Special versions and certificates acc. to DIN EN 10204 available on request.

Mini-blow-off valves

stainless steel, not type-tested

Manual adjustment of the blow-off pressure (lock nut).

For compressed air and non-toxic, non-flammable gases, cannot be used for liquids due to free blow-off, not suitable for steam.

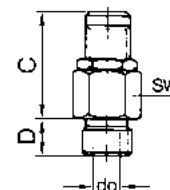

Material	Stainless steel 1.4305
Spring	Stainless steel 1.4310
Operating pressure	0.5 - 60 bar
Operating temperature	-20 to 180 °C
Sealant	FKM

Mini-blow-off valve, stainless steel, G 1/8

Art. No.	Type No.	Thread	Set pressure bar	Max. blow-off rate l/min	C mm	D mm	a/f mm	do mm
103915	218.10-ES	G 1/8	0.5 - 1	50	27.0	7.0	16	3.0
103916	218.11-ES	G 1/8	1 - 4	200	27.0	7.0	16	3.0
103917	218.12-ES	G 1/8	3 - 7	350	27.0	7.0	16	3.0
103918	218.13-ES	G 1/8	6 - 12	650	27.0	7.0	16	3.0
103919	218.14-ES	G 1/8	10 - 18	870	27.0	7.0	16	3.0
103920	218.15-ES	G 1/8	16 - 32	1600	27.0	7.0	16	3.0
103921	218.16-ES	G 1/8	30 - 60	3000	27.0	7.0	16	3.0

Mini-blow-off valve, stainless steel, G 1/4

Art. No.	Type No.	Thread	Set pressure bar	Max. blow-off rate l/min	C mm	D mm	a/f mm	do mm
103922	218.20-ES	G 1/4	0.5 - 1	50	27.0	7.0	16	3.0
103923	218.21-ES	G 1/4	1 - 4	200	27.0	7.0	16	3.0
103924	218.22-ES	G 1/4	3 - 7	350	27.0	7.0	16	3.0
103925	218.23-ES	G 1/4	6 - 12	650	27.0	7.0	16	3.0
103926	218.24-ES	G 1/4	10 - 18	870	27.0	7.0	16	3.0
103927	218.25-ES	G 1/4	16 - 32	1600	27.0	7.0	16	3.0
103928	218.26-ES	G 1/4	30 - 60	3000	27.0	7.0	16	3.0



218.21-ES



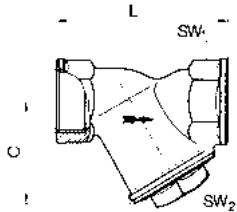

Strainers

Brass



Suitable for domestic water services, heating and air conditioning plants or compressed air systems. Not suitable for steam.

Housing	Brass
Head piece	Brass
Screen	Stainless steel
Sealant	NBR O-ring
Standard thread	G thread acc. to ISO 228-1, tolerance class B
Operating temperature	-20 to 110 °C



60-3 M

Dirt strainer, sieve insert stainless steel, mesh width 0.5 mm and 0.8 mm

Art. No.	Type No.	Thread	DN	Max. operating pressure bar	C mm	L mm	a/f 1 mm	a/f 2 mm	Mesh size mm
105688	60-1 M	G 1/4	8	20	40.0	55.0	18	20	0.5
105689	60-2 M	G 3/8	10	20	40.0	55.0	21	20	0.5
105690	60-3 M	G 1/2	15	20	40.0	58.0	25	20	0.5
105691	60-4 M	G 3/4	20	20	48.0	70.0	31	27	0.5
105692	60-5 M	G 1	25	20	56.0	87.0	38	32	0.5
105693	60-6 M	G 1 1/4	32	20	64.0	96.0	47	36	0.5
105694	60-7 M	G 1 1/2	40	20	73.0	106.0	57	38	0.5
105695	60-8 M	G 2	50	20	89.0	126.0	67	46	0.5
140984	60-9 M	G 2 1/2	65	16	105.0	150.0	85	48	0.8
140985	60-10 M	G 3	80	16	120.0	169.0	99	55	0.8
126304	60-11 M	G 4	100	16	162.0	219.0	125	100	0.8

Dirt strainer, sieve insert stainless steel, mesh width 0.2 mm

Art. No.	Type No.	Thread	DN	Max. operating pressure bar	C mm	L mm	a/f 1 mm	a/f 2 mm	Mesh size mm
140986	60-1 M-0,2	G 1/4	8	20	40.0	55.0	18	20	0.2
140987	60-2 M-0,2	G 3/8	10	20	40.0	55.0	21	20	0.2
140988	60-3 M-0,2	G 1/2	15	20	40.0	58.0	25	20	0.2
140989	60-4 M-0,2	G 3/4	20	20	48.0	70.0	31	27	0.2
140990	60-5 M-0,2	G 1	25	20	56.0	87.0	38	32	0.2
140991	60-6 M-0,2	G 1 1/4	32	20	64.0	96.0	47	36	0.2
140992	60-7 M-0,2	G 1 1/2	40	20	73.0	106.0	57	38	0.2
140993	60-8 M-0,2	G 2	50	20	89.0	126.0	67	46	0.2

Replacement screen for brass strainers, mesh width 0.5 mm and 0.8 mm

Art. No.	Type No.	Description
105696	62 M	For port size G 1/4, G 3/8, G 1/2
105697	63 M	For port size G 3/4
105698	64 M	For port size G 1
105699	65 M	For port size G 1 1/4
105700	66 M	For port size G 1 1/2
105701	67 M	For port size G 2
141017	68 M	For port size G 2 1/2
141018	69 M	For port size G 3
141019	70 M	For port size G 4

Replacement screen for brass strainers, mesh width 0.2 mm

Art. No.	Type No.	Description
141026	62 M-0,2	For port size G 1/4, G 3/8, G 1/2
141027	63 M-0,2	For port size G 3/4
141028	64 M-0,2	For port size G 1
141029	65 M-0,2	For port size G 1 1/4
141030	66 M-0,2	For port size G 1 1/2
141031	67 M-0,2	For port size G 2



62 M



62 M-0,2

Strainers

Red brass



For liquids, gases, steam, water, mineral, fuel and hydraulic oils, fuels and other non-corrosive media in a liquid or gaseous state.

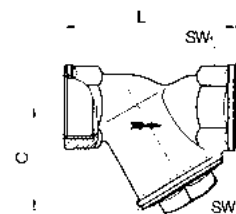

Housing	Red brass
Head piece	Brass
Sealant	FKM (FPM) O-ring
Max. operating pressure	25 bar
Operating temperature	-10 to 150 °C

Dirt strainer, sieve insert stainless steel, mesh width 0.25 mm

Art. No.	Type No.	Thread	DN	C mm	L mm	a/f 1 mm	a/f 2 mm	Screen
105659	60-1/K	G 1/4	8	34.0	56.0	21	17	Double stainless steel screen
105660	60-2/K	Rp 3/8	10	34.0	63.5	22	17	Double stainless steel screen
105661	60-3/K	Rp 1/2	15	42.0	66.5	27	22	Double stainless steel screen
105662	60-4/K	Rp 3/4	20	52.0	76.5	32	27	Double stainless steel screen
105663	60-5/K	G 1	25	61.0	90.0	38	32	Double stainless steel screen
105664	60-6/K	G 1 1/4	32	73.0	112.0	47	41	Double stainless steel screen
105665	60-7/K	G 1 1/2	40	82.0	120.0	54	46	Double stainless steel screen
105666	60-8/K	G 2	50	94.0	150.0	66	56	Double stainless steel screen



60-3/K

Dirt strainer, sieve insert stainless steel, mesh width 0.6 mm

Art. No.	Type No.	Thread	DN	C mm	L mm	a/f 1 mm	a/f 2 mm	Screen
143321	60-1/K-0,6	G 1/4	8	34.0	56.0	21	17	Double stainless steel screen
143322	60-2/K-0,6	Rp 3/8	10	34.0	63.5	22	17	Double stainless steel screen
143323	60-3/K-0,6	Rp 1/2	15	42.0	66.5	27	22	Double stainless steel screen
143324	60-4/K-0,6	Rp 3/4	20	52.0	76.5	32	27	Double stainless steel screen
143325	60-5/K-0,6	G 1	25	61.0	90.0	38	32	Double stainless steel screen
143326	60-6/K-0,6	G 1 1/4	32	73.0	112.0	47	41	Simple stainless steel screen
143327	60-7/K-0,6	G 1 1/2	40	82.0	120.0	54	46	Double stainless steel screen
143328	60-8/K-0,6	G 2	50	94.0	150.0	66	56	Double stainless steel screen

Spare parts set for red brass strainers, mesh width 0.25 mm

Art. No.	Type No.	Description
105667	60-2/ETS	For port size G 1/4, Rp 3/8
105668	60-3/ETS	For port size Rp 1/2
105669	60-4/ETS	For port size Rp 3/4
105670	60-5/ETS	For port size G 1
105671	60-6/ETS	For port size G 1 1/4
105672	60-7/ETS	For port size G 1 1/2
105673	60-8/ETS	For port size G 2



60-2/ETS

Spare parts set for red brass strainers, mesh width 0.6 mm

Art. No.	Type No.	Description
143329	60-2/ETS-0,6	For port size G 1/4, Rp 3/8
143330	60-3/ETS-0,6	For port size Rp 1/2
143331	60-4/ETS-0,6	For port size Rp 3/4
143332	60-5/ETS-0,6	For port size G 1
143333	60-6/ETS-0,6	For port size G 1 1/4
143334	60-7/ETS-0,6	For port size G 1 1/2
143335	60-8/ETS-0,6	For port size G 2

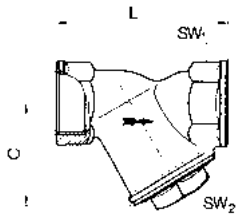

Strainers

stainless steel

Housing	Stainless steel 1.4401 / 1.4408
Head piece	Stainless steel 1.4401 / 1.4408
Screen	Stainless steel
Mesh size	0.6 mm
Standard thread	G thread acc. to ISO 228-1
Max. operating pressure	40 bar
Max. medium temperature	180 °C
Operating temperature	-20 to 180 °C



60-3 ES

Dirt strainer, sieve insert stainless steel, mesh width 0.6 mm

Art. No.	Type No.	Thread	DN	C mm	L mm	a/f 1 mm	a/f 2 mm
105674	60-1 ES	G 1/4	8	47.0	65.0	26	19
105675	60-2 ES	G 3/8	10	47.0	65.0	26	19
105676	60-3 ES	G 1/2	15	47.0	65.0	26	19
105677	60-4 ES	G 3/4	20	60.0	80.0	32	21
105678	60-5 ES	G 1	25	71.0	90.0	41	27
105679	60-6 ES	G 1 1/4	32	77.0	105.0	49	28
105680	60-7 ES	G 1 1/2	40	87.0	120.0	56	32
105681	60-8 ES	G 2	50	103.0	140.0	69	41



62 ES

Replacement screen for stainless steel strainers

Art. No.	Type No.	Description
105682	62 ES	For port size G 1/4, G 3/8, G 1/2
105683	63 ES	For port size G 3/4
105684	64 ES	For port size G 1
105685	65 ES	For port size G 1 1/4
105686	66 ES	For port size G 1 1/2
105687	67 ES	For port size G 2

Notes

A large grid of small dots for taking notes, covering most of the page.





DRIVELESS?

IMPOSSIBLE!

Pneumatic cylinders



Round cylinders (ISO 6432)
Ø 16 to 25 mm
Page 374-376



Round cylinders (ISO 6432)
Ø 8 to 25 mm
Page 377-381



Round cylinders
Ø 32 to 50 mm
Page 381-383



Short-stroke cylinders
Page 384-385



LINER compact cylinders
Page 386-393



Standard cylinders
Page 394-402

Piston rod-free cylinders



Rodless cylinders
ZRL1 series
Page 403-409



Rodless cylinders
6.DD series
Page 410-413

Booster



Double piston pressure multiplier (boosters)
Page 414



Compressed air tanks
Page 415

Pilot valves



3/2-way miniature valves,
mechanically operated
Page 416



3/2-way miniature valves,
manually operated
Page 417



3/2-way valves for panel mounting,
manually operated
Page 418



5/2-way valves for panel mounting,
manually operated
Page 419



3/2, 5/2 and 5/3-way valves,
manually operated
Page 421



3/2, 5/2 and 5/3-way valves,
pneumatic
Page 422



3/2, 5/2 and 5/3-way valves,
electro-pneumatic
Page 423-425



Feed blocks
for the pilot valves
Page 426



Multiple manifold bases
for the pilot valves
Page 426-427



5/2-way-robust type
Page 427-428

NAMUR valves



3/2 and 5/2-way valves
with NAMUR
Page 429



3/2 and 5/2-way valves
with NAMUR
Page 430



Flow regulators
for NAMUR valves
Page 431

Miniature solenoid valves



3/2-way types
Page 432-433

Foot-operated valves



3/2- and 5/2-way types
Page 434

Valve terminals



Modular valve system,
»HDM« series
Page 435-437

Logic elements / Other pneumatic valves



Pneumatic logic elements
Page 438



OR valves
Page 438



Pneumatic logic element:
Timer
Page 439

Logic elements /
Other pneumatic valves

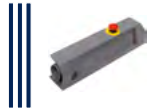

Two-hand
safety valve
Page 439

Inline function connectors

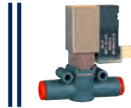

3/2-way Solenoid valves
Page 449-450

Inline function connectors



Bidirectional flow control
valves / Unidirectional flow
control valves
Page 441

Function fittings



Unidirectional flow control
valves
Page 451-454



Pressure regulators
Page 442



Throttle check valves
Page 451-454



Pressure gauges
Page 443



Bidirectional flow control
valves
Page 455-456



Quick-exhaust valves
Page 443-444



Bidirectional flow control
valve
Page 455-456



Pressure indicators
Page 444



Toggle valves
Page 457-458



3/2-way valve, pneumatically
actuated
Page 445



Mini pressure regulators
Page 459



Unidirectional valves
Page 446



Quick-exhaust valves
Page 460



Pneumatically piloted stop
valves
Page 447



Pneumatically piloted
stop valves
Page 460



Shut-off valves
Page 448



Stop valves pneumatically
operated
Page 461

Notes

A large grid of small dots for taking notes, covering most of the page.



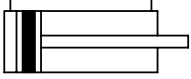

Round cylinders TP

acc. ISO 6432, Ø 16 to 25

PLUS

Inexpensive standard version with aluminum pipe and magnet piston.
Suitable for filtered (50 µm), unlubricated or lubricated compressed air.
If lubrication is used, it must be continuous.

Max. working pressure	10 bar
Temperature range	-10 to 60 °C
Design	Connection: Aluminium pipe / end caps flanged
Jacket	Aluminium alloy, anodised
Cap	Technopolymer
Bottom	Technopolymer
Bushing	Technopolymer
Piston rod gasket	PU
Piston gasket	PU



8.DM.20050

Round cylinders, double acting, magnetic, non-cushioned

Art. No.	Type No.	Piston Ø mm	Stroke mm	Connection	Piston rod ET	Piston rod
105702	8.DM.16010	16	10	M5	M6	Stainless steel 1.4301
105703	8.DM.16025	16	25	M5	M6	Stainless steel 1.4301
105704	8.DM.16050	16	50	M5	M6	Stainless steel 1.4301
105705	8.DM.16080	16	80	M5	M6	Stainless steel 1.4301
105706	8.DM.16100	16	100	M5	M6	Stainless steel 1.4301
105707	8.DM.16125	16	125	M5	M6	Stainless steel 1.4301
105708	8.DM.16160	16	160	M5	M6	Stainless steel 1.4301
105709	8.DM.16200	16	200	M5	M6	Stainless steel 1.4301
105710	8.DM.20010	20	10	G 1/8	M8	C45 steel, hard chrome-plated
105711	8.DM.20025	20	25	G 1/8	M8	C45 steel, hard chrome-plated
105712	8.DM.20050	20	50	G 1/8	M8	C45 steel, hard chrome-plated
105713	8.DM.20080	20	80	G 1/8	M8	C45 steel, hard chrome-plated
105714	8.DM.20100	20	100	G 1/8	M8	C45 steel, hard chrome-plated
105715	8.DM.20125	20	125	G 1/8	M8	C45 steel, hard chrome-plated
105716	8.DM.20160	20	160	G 1/8	M8	C45 steel, hard chrome-plated
105717	8.DM.20200	20	200	G 1/8	M8	C45 steel, hard chrome-plated
105718	8.DM.20250	20	250	G 1/8	M8	C45 steel, hard chrome-plated
105719	8.DM.20500	20	500	G 1/8	M8	C45 steel, hard chrome-plated
105720	8.DM.25010	25	10	G 1/8	M10x1.25	C45 steel, hard chrome-plated
105721	8.DM.25025	25	25	G 1/8	M10x1.25	C45 steel, hard chrome-plated
105722	8.DM.25050	25	50	G 1/8	M10x1.25	C45 steel, hard chrome-plated
105723	8.DM.25080	25	80	G 1/8	M10x1.25	C45 steel, hard chrome-plated
105724	8.DM.25100	25	100	G 1/8	M10x1.25	C45 steel, hard chrome-plated
105725	8.DM.25125	25	125	G 1/8	M10x1.25	C45 steel, hard chrome-plated
105726	8.DM.25160	25	160	G 1/8	M10x1.25	C45 steel, hard chrome-plated
105727	8.DM.25200	25	200	G 1/8	M10x1.25	C45 steel, hard chrome-plated
105728	8.DM.25250	25	250	G 1/8	M10x1.25	C45 steel, hard chrome-plated
105729	8.DM.25500	25	500	G 1/8	M10x1.25	C45 steel, hard chrome-plated

- Other sizes of fixing parts and accessories can be found in our online shop.
- Fixing parts and accessories please look at page 375-376
- Maximum recommended stroke: Ø 16 = stroke 200, Ø 20 and Ø 25 = stroke 500.
Longer strokes can result in malfunctions.

Other types can be supplied at short notice on request:



Double-acting with through rod, with or without magnet, non-cushioned.
Types with piston rod made of stainless steel.

For other versions, see our round cylinders ISO 6432, Ø 8 to 25.

Fixing parts and accessories for round cylinders TP

(ISO 6432) Ø 8 to 25

Foot model

Art. No.	Type No.	For cylinders	Suitable for piston Ø mm	Material
156764	453.107	ISO 6432	12 - 16	galvanised steel
156765	453.108	ISO 6432	20 - 25	galvanised steel



453.107

Flange model

Art. No.	Type No.	For cylinders	Suitable for piston Ø mm	Material
156767	453.110	ISO 6432	12 - 16	galvanised steel
156768	453.111	ISO 6432	20 - 25	galvanised steel



453.110

Intermediate hinge

Art. No.	Type No.	For cylinders	Suitable for piston Ø mm	Material
156770	453.113	ISO 6432	12 - 16	galvanised steel
156771	453.114	ISO 6432	20 - 25	galvanised steel



453.113

Head nut for cover / base

Art. No.	Type No.	For cylinders	Suitable for piston Ø mm	Material	Thread
105734	435.52-M	ISO 6432	12 - 16	brass	M16x1.5
105735	435.53-M	ISO 6432	20 - 25	brass	M22x1.5



435.53-M

Rod nut

Art. No.	Type No.	For cylinders	Suitable for piston Ø mm	Material	Piston rod thread
105736	436.31-M	ISO 6432	12 - 16	Steel	M6
105737	436.32-M	ISO 6432, compact cylinders	20 20 - 25	Steel	M8
105738	436.33-M	ISO 6432 compact cyl. standard cyl.	25 32 - 40 32	Steel	M10x1.25



436.33-M

Fork model, with folding spring bolts

Art. No.	Type No.	For cylinders	Suitable for piston Ø mm	Piston rod thread
179919	GAKAP2M6	ISO 6432	12-16	M6x1
179920	GAKAP2M8	ISO 6432 ISO 21287	20 20-25	M8x1.25
179921	GAKAP2M10X125	ISO 6432 Round cylinder ISO 21287 ISO 15552	25 32 32-40 32	M10x1.25



GAKAP2M10X125

Rod eye model

Art. No.	Type No.	For cylinders	Suitable for piston Ø mm	Piston rod thread
179930	GEKAP6M6	ISO 6432	12-16	M6x1
179931	GEKAP6M8	ISO 6432 ISO 21287	20 20-25	M8x1.25
179932	GEKAP6M10X125	ISO 6432 Round cylinder ISO 21287 ISO 15552	25 32 32-40 32	M10x1.25



GEKAP6M10X125

Counter hinge model, with bolt and retainer ring

Art. No.	Type No.	For cylinders	Suitable for piston Ø mm	Material	Bolt Ø mm
156773	453.116	ISO 6432	12 - 16	galvanised steel	6
156774	453.117	ISO 6432	20 - 25	galvanised steel	8



453.116

Fixing parts and accessories for round cylinders TP

(ISO 6432) Ø 8 to 25



AKM6

Self-aligning rod coupler

Art. No.	Type No.	For cylinders	Suitable for piston Ø mm	Piston rod thread
179941	AKM6	ISO 6432	12-16	M6x1
179942	AKM8	ISO 6432 / ISO 21287	20 / 20-25	M8x1.25



435.168-M

Sensor support (with T-slot adapter)

Art. No.	Type No.	For cylinders	Material	Description
105747	435.168-M	Round cylinders	Tightening strap = stainless steel, sensor holder = plastic	Universal sensor holder Ø 8 to Ø 50



235.04-M-1

Sensor for the T-slots and rectangular slots

Art. No.	Type No.	For cylinders	Description
194356	235.03-M-1	for all cylinders (not for short-stroke cylinders)	REED sensor, 2-wire, with 2.5 m cable length, LED
194357	235.04-M-1	for all cylinders (not for short-stroke cylinders)	REED sensor, 2-wire, with M8 plug, LED
194358	235.06-M-1	for all cylinders (not for short-stroke cylinders)	HALL sensor, 3-wire, with 2.5 m cable length, PNP, LED
194359	235.07-M-1	for all cylinders (not for short-stroke cylinders)	HALL sensor, 3-wire, with M8 plug, PNP, LED

Round cylinders

acc. ISO 6432, Ø 8 to 25

PLUS

Single and double-acting cylinders, with magnetic piston.
Suitable for filtered, unlubricated or lubricated compressed air.
If lubrication is used, it must be continuous.



Max. working pressure	10 bar
Temperature range	-10 to 80 °C
Design	Flanged joint between stainless steel barrel and heads
Piston rod	C45 steel, hard chrome-plated
Jacket	Stainless steel 1.4301
Piston	Synthetic (acetal) resin
Sealant	NBR

Round cylinders, double acting, with magnet, non-cushioned

Art. No.	Type No.	Piston Ø mm	Stroke mm	Connection	Piston rod thread
105752	1.DM.08010	8	10	M5	M4
105753	1.DM.08025	8	25	M5	M4
105754	1.DM.08050	8	50	M5	M4
105755	1.DM.08080	8	80	M5	M4
105756	1.DM.08100	8	100	M5	M4
105757	1.DM.10010	10	10	M5	M4
105758	1.DM.10025	10	25	M5	M4
105759	1.DM.10050	10	50	M5	M4
105760	1.DM.10080	10	80	M5	M4
105761	1.DM.10100	10	100	M5	M4
105762	1.DM.12010	12	10	M5	M6
105763	1.DM.12025	12	25	M5	M6
105764	1.DM.12050	12	50	M5	M6
105765	1.DM.12080	12	80	M5	M6
105766	1.DM.12100	12	100	M5	M6
105767	1.DM.12125	12	125	M5	M6
105768	1.DM.12160	12	160	M5	M6
105769	1.DM.12200	12	200	M5	M6
105770	1.DM.16010	16	10	M5	M6
105771	1.DM.16025	16	25	M5	M6
105772	1.DM.16050	16	50	M5	M6
105773	1.DM.16080	16	80	M5	M6
105774	1.DM.16100	16	100	M5	M6
105775	1.DM.16125	16	125	M5	M6
105776	1.DM.16160	16	160	M5	M6
105777	1.DM.16200	16	200	M5	M6
105778	1.DM.20010	20	10	G 1/8	M8
105779	1.DM.20025	20	25	G 1/8	M8
105780	1.DM.20050	20	50	G 1/8	M8
105781	1.DM.20080	20	80	G 1/8	M8
105782	1.DM.20100	20	100	G 1/8	M8
105783	1.DM.20125	20	125	G 1/8	M8
105784	1.DM.20160	20	160	G 1/8	M8
105785	1.DM.20200	20	200	G 1/8	M8
105786	1.DM.20250	20	250	G 1/8	M8
105787	1.DM.25010	25	10	G 1/8	M10x1.25
105788	1.DM.25025	25	25	G 1/8	M10x1.25
105789	1.DM.25050	25	50	G 1/8	M10x1.25
105790	1.DM.25080	25	80	G 1/8	M10x1.25
105791	1.DM.25100	25	100	G 1/8	M10x1.25
105792	1.DM.25125	25	125	G 1/8	M10x1.25
105793	1.DM.25160	25	160	G 1/8	M10x1.25



1.DM.16050



Round cylinders

acc. ISO 6432, Ø 8 to 25

PLUS

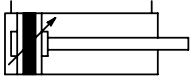

1.DMD.25050

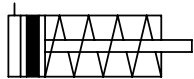

1.EM.20050

Round cylinders, double acting, with magnet, non-cushioned

Art. No.	Type No.	Piston Ø mm	Stroke mm	Connection	Piston rod thread
105794	1.DM.25200	25	200	G 1/8	M10x1.25
105795	1.DM.25250	25	250	G 1/8	M10x1.25

Round cylinders, double acting, with magnet, cushioned

Art. No.	Type No.	Piston Ø mm	Stroke mm	Connection	Piston rod thread
105796	1.DMD.16010	16	10	M5	M6
105797	1.DMD.16025	16	25	M5	M6
105798	1.DMD.16050	16	50	M5	M6
105799	1.DMD.16080	16	80	M5	M6
105800	1.DMD.16100	16	100	M5	M6
105801	1.DMD.16125	16	125	M5	M6
105802	1.DMD.16160	16	160	M5	M6
105803	1.DMD.16200	16	200	M5	M6
105804	1.DMD.20010	20	10	G 1/8	M8
105805	1.DMD.20025	20	25	G 1/8	M8
105806	1.DMD.20050	20	50	G 1/8	M8
105807	1.DMD.20080	20	80	G 1/8	M8
105808	1.DMD.20100	20	100	G 1/8	M8
105809	1.DMD.20125	20	125	G 1/8	M8
105810	1.DMD.20160	20	160	G 1/8	M8
105811	1.DMD.20200	20	200	G 1/8	M8
105812	1.DMD.20250	20	250	G 1/8	M8
105813	1.DMD.25010	25	10	G 1/8	M10x1,25
105814	1.DMD.25025	25	25	G 1/8	M10x1,25
105815	1.DMD.25050	25	50	G 1/8	M10x1,25
105816	1.DMD.25080	25	80	G 1/8	M10x1,25
105817	1.DMD.25100	25	100	G 1/8	M10x1,25
105818	1.DMD.25125	25	125	G 1/8	M10x1,25
105819	1.DMD.25160	25	160	G 1/8	M10x1,25
105820	1.DMD.25200	25	200	G 1/8	M10x1,25
105821	1.DMD.25250	25	250	G 1/8	M10x1,25

Round cylinders, single-acting (pressureless in the retracted position), with magnet, non-cushioned

Art. No.	Type No.	Piston Ø mm	Stroke mm	Connection	Piston rod thread
105822	1.EM.08010	8	10	M5	M4
105823	1.EM.08025	8	25	M5	M4
105824	1.EM.08050	8	50	M5	M4
105825	1.EM.10010	10	10	M5	M4
105826	1.EM.10025	10	25	M5	M4
105827	1.EM.10050	10	50	M5	M4
105828	1.EM.12010	12	10	M5	M6
105829	1.EM.12025	12	25	M5	M6
105830	1.EM.12050	12	50	M5	M6
105831	1.EM.16010	16	10	M5	M6
105832	1.EM.16025	16	25	M5	M6
105833	1.EM.16050	16	50	M5	M6

Round cylinders

acc. ISO 6432, Ø 8 to 25

PLUS

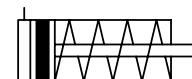

Round cylinders, single-acting (pressureless in the retracted position), with magnet, non-cushioned

Art. No.	Type No.	Piston Ø mm	Stroke mm	Connection	Piston rod thread
105834	1.EM.20010	20	10	G 1/8	M8
105835	1.EM.20025	20	25	G 1/8	M8
105836	1.EM.20050	20	50	G 1/8	M8
105837	1.EM.25010	25	10	G 1/8	M10x1.25
105838	1.EM.25025	25	25	G 1/8	M10x1.25
105839	1.EM.25050	25	50	G 1/8	M10x1.25



1.EM.20050

- Other sizes of fixing parts and accessories can be found in our online shop.
- Fixing parts and accessories please look at page 379-381
- Maximum recommended stroke:
 Double acting: Ø 8 to Ø 10 = stroke 100, Ø 12 to Ø 16 = stroke 200, Ø 20 to Ø 25 = stroke 500
 Single acting: Ø 8 to Ø 25 = stroke 50
 Longer strokes can result in malfunctions.

Other types can be supplied at short notice on request:

- Single-acting (pressureless in the retracted position) with axial bottom port, with magnet, non-cushioned
- Double-acting with axial bottom port, with magnet, non-cushioned
- Single-acting with through rod, with magnet, non-cushioned
- Double-acting with through rod, with magnet, non-cushioned
- Double-acting with through rod, with magnet, cushioned

Any non-standard stroke lengths can also be supplied as well as all-stainless steel and high-temperature versions (max. 150 °C) or combinations with guide units and piston rod locks (brake) for Ø 12 to Ø 25



Fixing parts and accessories for round cylinders

(ISO 6432) Ø 8 to 25

Foot model

Art. No.	Type No.	For cylinders	Suitable for piston Ø mm	Material
156763	453.106	ISO 6432	8 - 10	galvanised steel
156764	453.107	ISO 6432	12 - 16	galvanised steel
156765	453.108	ISO 6432	20 - 25	galvanised steel



453.107

Flange model

Art. No.	Type No.	For cylinders	Suitable for piston Ø mm	Material
156766	453.109	ISO 6432	8 - 10	galvanised steel
156767	453.110	ISO 6432	12 - 16	galvanised steel
156768	453.111	ISO 6432	20 - 25	galvanised steel



453.110

Intermediate hinge

Art. No.	Type No.	For cylinders	Suitable for piston Ø mm	Material
156769	453.112	ISO 6432	8 - 10	galvanised steel
156770	453.113	ISO 6432	12 - 16	galvanised steel
156771	453.114	ISO 6432	20 - 25	galvanised steel



453.113

Fixing parts and accessories for round cylinders

(ISO 6432) Ø 8 to 25



435.53-M



436.33-M



GAKAP2M10X125



GEKAP6M10X125



453.116



AKM6

Head nut for cover / base

Art. No.	Type No.	For cylinders	Suitable for piston Ø mm	Material	Thread
105842	435.51-M	ISO 6432	8 - 10	brass	M12x1.25
105734	435.52-M	ISO 6432	12 - 16	brass	M16x1.5
105735	435.53-M	ISO 6432	20 - 25	brass	M22x1.5

Rod nut

Art. No.	Type No.	For cylinders	Suitable for piston Ø mm	Material	Piston rod thread
105843	436.30-M	ISO 6432	8 - 10	Steel	M4
105736	436.31-M	ISO 6432	12 - 16	Steel	M6
105737	436.32-M	ISO 6432 compact cylinders	20 20 - 25	Steel	M8
105738	436.33-M	ISO 6432 compact cylinder standard cylinder	25 32 - 40 32	Steel	M10x1.25

Fork model, with folding spring bolts

Art. No.	Type No.	For cylinders	Suitable for piston Ø mm	Piston rod thread
179918	GAKAP2M4	ISO 6432	8-10	M4x0.7
179919	GAKAP2M6	ISO 6432	12-16	M6x1
179920	GAKAP2M8	ISO 6432 ISO 21287	20 20-25	M8x1.25
179921	GAKAP2M10X125	ISO 6432 Round cylinder ISO 21287 ISO 15552	25 32 32-40 32	M10x1.25

Rod eye model

Art. No.	Type No.	For cylinders	Suitable for piston Ø mm	Piston rod thread
179929	GEKAP6M4	ISO 6432	8-10	M4x0.7
179930	GEKAP6M6	ISO 6432	12-16	M6x1
179931	GEKAP6M8	ISO 6432 ISO 21287	20 20-25	M8x1.25
179932	GEKAP6M10X125	ISO 6432 Round cylinder ISO 21287 ISO 15552	25 32 32-40 32	M10x1.25

Counter hinge model, with bolt and retainer ring

Art. No.	Type No.	For cylinders	Suitable for piston Ø mm	Material	Bolt Ø mm
156772	453.115	ISO 6432	8 - 10	galvanised steel	4
156773	453.116	ISO 6432	12 - 16	galvanised steel	6
156774	453.117	ISO 6432	20 - 25	galvanised steel	8

Self-aligning rod coupler

Art. No.	Type No.	For cylinders	Suitable for piston Ø mm	Piston rod thread
179940	AKM4	ISO 6432	8-10	M4x0.7
179941	AKM6	ISO 6432	12-16	M6x1
179942	AKM8	ISO 6432 ISO 21287	20 20-25	M8x1.25

Fixing parts and accessories for round cylinders

(ISO 6432) Ø 8 to 25

Sensor support (with T-slot adapter)

Art. No.	Type No.	For cylinders	Material	Description
105747	435.168-M	Round cylinders	Tightening strap = stainless steel, sensor holder = plastic	Universal sensor holder Ø 8 to Ø 50



435.168-M

Sensor for the T-slots and rectangular slots

Art. No.	Type No.	For cylinders	Description
194356	235.03-M-1	for all cylinders (not for short-stroke cylinders)	REED sensor, 2-wire, with 2.5 m cable length, LED
194357	235.04-M-1	for all cylinders (not for short-stroke cylinders)	REED sensor, 2-wire, with M8 plug, LED
194358	235.06-M-1	for all cylinders (not for short-stroke cylinders)	HALL sensor, 3-wire, with 2.5 m cable length, PNP, LED
194359	235.07-M-1	for all cylinders (not for short-stroke cylinders)	HALL sensor, 3-wire, with M8 plug, PNP, LED



235.04-M-1

Round cylinders

Ø 32 to 50 mm

PLUS

Version with magnetic piston.
Suitable for filtered (50 µm), unlubricated or lubricated compressed air.
If lubrication is used, it must be continuous.

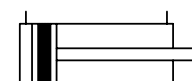

Max. working pressure	10 bar
Temperature range	-10 to 80 °C
Design	Screwed joint between stainless steel barrel and heads
Piston rod	C45 steel, hard chrome-plated
Jacket	Anodised aluminium
Piston	Technopolymer
Sealant	NBR

Round cylinders, double acting, with magnet, non-cushioned

Art. No.	Type No.	Piston Ø mm	Stroke mm	Connection	Piston rod thread
105847	2.DM.32025	32	25	G 1/8	M10x1.25
105848	2.DM.32050	32	50	G 1/8	M10x1.25
105849	2.DM.32080	32	80	G 1/8	M10x1.25
105850	2.DM.32100	32	100	G 1/8	M10x1.25
105851	2.DM.32125	32	125	G 1/8	M10x1.25
105852	2.DM.32160	32	160	G 1/8	M10x1.25
105853	2.DM.32200	32	200	G 1/8	M10x1.25
105854	2.DM.32250	32	250	G 1/8	M10x1.25
105855	2.DM.32320	32	320	G 1/8	M10x1.25
105856	2.DM.32400	32	400	G 1/8	M10x1.25
105857	2.DM.32500	32	500	G 1/8	M10x1.25
105858	2.DM.40025	40	25	G 1/4	M12x1.25
105859	2.DM.40050	40	50	G 1/4	M12x1.25
105860	2.DM.40080	40	80	G 1/4	M12x1.25
105861	2.DM.40100	40	100	G 1/4	M12x1.25
105862	2.DM.40125	40	125	G 1/4	M12x1.25
105863	2.DM.40160	40	160	G 1/4	M12x1.25



2.DM.32025

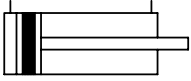

Round cylinders

Ø 32 to 50 mm

PLUS



2.DM.32025

Round cylinders, double acting, with magnet, non-cushioned

Art. No.	Type No.	Piston Ø mm	Stroke mm	Connection	Piston rod thread
105864	2.DM.40200	40	200	G 1/4	M12x1.25
105865	2.DM.40250	40	250	G 1/4	M12x1.25
105866	2.DM.40320	40	320	G 1/4	M12x1.25
105867	2.DM.40400	40	400	G 1/4	M12x1.25
105868	2.DM.40500	40	500	G 1/4	M12x1.25
105869	2.DM.50025	50	25	G 1/4	M16x1.5
105870	2.DM.50050	50	50	G 1/4	M16x1.5
105871	2.DM.50080	50	80	G 1/4	M16x1.5
105872	2.DM.50100	50	100	G 1/4	M16x1.5
105873	2.DM.50125	50	125	G 1/4	M16x1.5
105874	2.DM.50160	50	160	G 1/4	M16x1.5
105875	2.DM.50200	50	200	G 1/4	M16x1.5
105876	2.DM.50250	50	250	G 1/4	M16x1.5
105877	2.DM.50320	50	320	G 1/4	M16x1.5
105878	2.DM.50400	50	400	G 1/4	M16x1.5
105879	2.DM.50500	50	500	G 1/4	M16x1.5

→ Fixing parts and accessories please look at page 382-383

→ Note: 500 mm is the maximum stroke available for the double-acting type

Other types can be supplied at short notice on request:

- Double-acting, with magnet, cushioned
- Single-acting with through rod, with magnet, non-cushioned
- Double-acting with through rod, with magnet, non-cushioned
- Double-acting with through rod, with magnet, cushioned

Any non-standard stroke lengths can also be supplied as well as all-stainless steel an high temperature versions (-10 °C to 150 °C), low temperature versions (-35 °C to 80 °C) or combinations with guide units and piston rod locks (brake).

Fixing parts and accessories for round cylinders

Ø 32 to 50 mm



436.12-M



436.52-M

Foot model

Art. No.	Type No.	For cylinders	Suitable for piston Ø mm	Material
105880	436.11-M	Round cylinder (nicht ISO 6432)	32	steel
105881	436.12-M	Round cylinder (nicht ISO 6432)	40	steel
105882	436.13-M	Round cylinder (nicht ISO 6432)	50	steel

Head nut for cover / base

Art. No.	Type No.	For cylinders	Suitable for piston Ø mm	Material	Thread
105883	436.51-M	Round cylinder (nicht ISO 6432)	32	steel	M30x1.5
105884	436.52-M	Round cylinder (nicht ISO 6432)	40	steel	M38x1.5
105885	436.53-M	Round cylinder (nicht ISO 6432)	50	steel	M45x1.5

Fixing parts and accessories for round cylinders

Ø 32 to 50 mm

Fork model, with folding spring bolts				
Art. No.	Type No.	For cylinders	Suitable for piston Ø mm	Piston rod thread
179921	GAKAP2M10X125	ISO 6432 Round cylinder ISO 21287 ISO 15552	25 32 32-40 32	M10x1.25
179922	GAKAP2M12X125	Round cylinder (not ISO 6432) ISO 21287 ISO 15552	40 50-63 40	M12x1.25
179923	GAKAP2M16X15	Round cylinder (not ISO 6432) ISO 21287 ISO 15552	50 80-100 50-63	M16x1.5



GAKAP2M10X125

Rod eye model				
Art. No.	Type No.	For cylinders	Suitable for piston Ø mm	Piston rod thread
179932	GEKAP6M10X125	ISO 6432 Round cylinder ISO 21287 ISO 15552	25 32 32-40 32	M10x1.25
179933	GEKAP6M12X125	Round cylinder (not ISO 6432) ISO 21287 ISO 15552	40 50-63 40	M12x1.25
179934	GEKAP6M16X15	Round cylinder (not ISO 6432) ISO 21287 ISO 15552	50 80-100 50-63	M16x1.5



GEKAP6M10X125

Self-aligning rod coupler				
Art. No.	Type No.	For cylinders	Suitable for piston Ø mm	Piston rod thread
179943	AKM10X125	ISO 6432 Round cylinder ISO 21287 ISO 15552	25 / 32 / 32-40 / 32	M10x1.25
179944	AKM12X125	Round cylinder (not ISO 6432) ISO 21287 ISO 15552	40 50-63 40	M12x1.25
179945	AKM16X15	Round cylinder (not ISO 6432) ISO 21287 ISO 15552	50 80-100 50-63	M16x1.5



AKM10X125

Counter-hinge model, with 2 threaded bolts and retaining rings				
Art. No.	Type No.	For cylinders	Suitable for piston Ø mm	Material
105893	436.21-M	Round cylinder (not ISO 6432)	32	steel
105894	436.22-M	Round cylinder (not ISO 6432)	40	steel
105895	436.23-M	Round cylinder (not ISO 6432)	50	steel



436.22-M

Sensor support (with T-slot adapter)				
Art. No.	Type No.	For cylinders	Material	Description
105747	435.168-M	Round cylinders	Tightening strap = stainless steel, sensor holder = plastic	Universal sensor holder Ø 8 to Ø 50



435.168-M

Sensor for the T-slots and rectangular slots				
Art. No.	Type No.	For cylinders	Description	
194356	235.03-M-1	for all cylinders (not for short-stroke cylinders)	REED sensor, 2-wire, with 2.5 m cable length, LED	
194357	235.04-M-1	for all cylinders (not for short-stroke cylinders)	REED sensor, 2-wire, with M8 plug, LED	
194358	235.06-M-1	for all cylinders (not for short-stroke cylinders)	HALL sensor, 3-wire, with 2.5 m cable length, PNP, LED	
194359	235.07-M-1	for all cylinders (not for short-stroke cylinders)	HALL sensor, 3-wire, with M8 plug, PNP, LED	



235.04-M-1

Short-stroke cylinders

Ø 12 to 80

PLUS

Suitable for installation in limited spaces.

Supplied with magnet.

Suitable for filtered compressed air, lubricated (ensure continuity) or unlubricated.

Max. working pressure	10 bar
Temperature range	-10 to 80 °C
Piston rod	C45 steel, hard chrome-plated
Jacket	Aluminum alloy, anodised
Piston gasket	NBR (additional charge for PU and FKM)
Piston rod gasket	NBR (additional charge for PU and FKM)

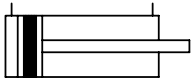

3.DM.12005

Short-stroke cylinders, double acting, magnetic, non-cushioned

Art. No.	Type No.	Piston Ø mm	Stroke mm	Connection	Piston rod IT
105896	3.DM.12005	12	5	M5	M3
105897	3.DM.12010	12	10	M5	M3
105898	3.DM.12025	12	25	M5	M3
105899	3.DM.12030	12	30	M5	M3
105900	3.DM.12040	12	40	M5	M3
105901	3.DM.16005	16	5	M5	M5
105902	3.DM.16010	16	10	M5	M5
105903	3.DM.16025	16	25	M5	M5
105904	3.DM.16030	16	30	M5	M5
105905	3.DM.16040	16	40	M5	M5
105906	3.DM.20005	20	5	M5	M5
105907	3.DM.20010	20	10	M5	M5
105908	3.DM.20025	20	25	M5	M5
105909	3.DM.20030	20	30	M5	M5
105910	3.DM.20040	20	40	M5	M5
105911	3.DM.20050	20	50	M5	M5
105912	3.DM.25005	25	5	G 1/8	M5
105913	3.DM.25010	25	10	G 1/8	M5
105914	3.DM.25025	25	25	G 1/8	M5
105915	3.DM.25030	25	30	G 1/8	M5
105916	3.DM.25040	25	40	G 1/8	M5
105917	3.DM.25050	25	50	G 1/8	M5
105918	3.DM.32005	32	5	G 1/8	M6
105919	3.DM.32010	32	10	G 1/8	M6
105920	3.DM.32025	32	25	G 1/8	M6
105921	3.DM.32030	32	30	G 1/8	M6
105922	3.DM.32040	32	40	G 1/8	M6
105923	3.DM.32050	32	50	G 1/8	M6
105924	3.DM.40005	40	5	G 1/8	M6
105925	3.DM.40010	40	10	G 1/8	M6
105926	3.DM.40025	40	25	G 1/8	M6
105927	3.DM.40030	40	30	G 1/8	M6
105928	3.DM.40040	40	40	G 1/8	M6
105929	3.DM.40050	40	50	G 1/8	M6
105930	3.DM.50005	50	5	G 1/8	M8
105931	3.DM.50010	50	10	G 1/8	M8
105932	3.DM.50025	50	25	G 1/8	M8
105933	3.DM.50030	50	30	G 1/8	M8
105934	3.DM.50040	50	40	G 1/8	M8
105935	3.DM.50050	50	50	G 1/8	M8
105936	3.DM.50070	50	70	G 1/8	M8

Short-stroke cylinders

Ø 12 to 80

PLUS

Short-stroke cylinders, double acting, magnetic, non-cushioned

Art. No.	Type No.	Piston Ø mm	Stroke mm	Connection	Piston rod IT
105937	3.DM.63005	63	5	G 1/8	M8
105938	3.DM.63010	63	10	G 1/8	M8
105939	3.DM.63025	63	25	G 1/8	M8
105940	3.DM.63030	63	30	G 1/8	M8
105941	3.DM.63040	63	40	G 1/8	M8
105942	3.DM.63050	63	50	G 1/8	M8
105943	3.DM.63070	63	70	G 1/8	M8
105944	3.DM.80005	80	5	G 1/4	M10
105945	3.DM.80010	80	10	G 1/4	M10
105946	3.DM.80025	80	25	G 1/4	M10
105947	3.DM.80030	80	30	G 1/4	M10
105948	3.DM.80040	80	40	G 1/4	M10
105949	3.DM.80050	80	50	G 1/4	M10
105950	3.DM.80070	80	70	G 1/4	M10
105951	3.DM.80100	80	100	G 1/4	M10



3.DM.12005

Short-stroke cylinders, single-acting, magnetic

Art. No.	Type No.	Piston Ø mm	Stroke mm	Connection	Piston rod IT
105952	3.EMF.12010	12	10	M5	M3
105953	3.EMF.12025	12	25	M5	M3
105954	3.EMF.16010	16	10	M5	M5
105955	3.EMF.16025	16	25	M5	M5
105956	3.EMF.20010	20	10	M5	M5
105957	3.EMF.20025	20	25	M5	M5
105958	3.EMF.25010	25	10	G 1/8	M5
105959	3.EMF.25025	25	25	G 1/8	M5
105960	3.EMF.32010	32	10	G 1/8	M6
105961	3.EMF.32025	32	25	G 1/8	M6
105962	3.EMF.40010	40	10	G 1/8	M6
105963	3.EMF.40025	40	25	G 1/8	M6
105964	3.EMF.50025	50	25	G 1/8	M8
105965	3.EMF.63025	63	25	G 1/8	M8

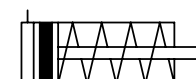

3.EMF.12010

➔ Other types, e.g. increased thermal stability, non-standard strokes, through rod, non-rotating version, etc., available on request.

Accessories for short-stroke cylinders

Ø 12 to 80

Reed magnetic sensor (incl. 2.5 m cable)

Art. No.	Type No.	For cylinders	Suitable for piston Ø mm
105966	435.779-M	Short-stroke cylinder	12 - 80



435.779-M

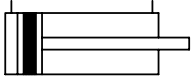

LINER compact cylinders

acc. to ISO 21287 Ø 20 - 100

PLUS

New series acc. to ISO 21287 characterised by a very short and compact design. The standard type features a magnetic piston. Piston rod optionally with male or female thread. Suitable for filtered, unlubricated or lubricated compressed air. If lubrication is used, it must be continuous.

Max. working pressure	10 bar
Piston rod	C45 steel, hard chrome-plated
Jacket	Anodised aluminium jacket with T-slots
Sealant	NBR

Compact cylinders, double-acting (with magnet), non-cushioned, female piston rod

Art. No.	Type No.	Piston Ø mm	Stroke mm	Connection	Piston rod IT	Temperature range °C
105967	7.DMI.20005	20	5	M5	M6	-10 to 60
105968	7.DMI.20010	20	10	M5	M6	-10 to 60
105969	7.DMI.20015	20	15	M5	M6	-10 to 60
105970	7.DMI.20020	20	20	M5	M6	-10 to 60
105971	7.DMI.20025	20	25	M5	M6	-10 to 60
105972	7.DMI.20030	20	30	M5	M6	-10 to 60
105973	7.DMI.20040	20	40	M5	M6	-10 to 60
105974	7.DMI.20050	20	50	M5	M6	-10 to 60
105975	7.DMI.20060	20	60	M5	M6	-10 to 60
105976	7.DMI.25005	25	5	M5	M6	-10 to 60
105977	7.DMI.25010	25	10	M5	M6	-10 to 60
105978	7.DMI.25015	25	15	M5	M6	-10 to 60
105979	7.DMI.25020	25	20	M5	M6	-10 to 60
105980	7.DMI.25025	25	25	M5	M6	-10 to 60
105981	7.DMI.25030	25	30	M5	M6	-10 to 60
105982	7.DMI.25040	25	40	M5	M6	-10 to 60
105983	7.DMI.25050	25	50	M5	M6	-10 to 60
105984	7.DMI.25060	25	60	M5	M6	-10 to 60
105985	7.DMI.32005	32	5	G 1/8	M8	-10 to 60
105986	7.DMI.32010	32	10	G 1/8	M8	-10 to 60
105987	7.DMI.32015	32	15	G 1/8	M8	-10 to 60
105988	7.DMI.32020	32	20	G 1/8	M8	-10 to 60
105989	7.DMI.32025	32	25	G 1/8	M8	-10 to 60
105990	7.DMI.32030	32	30	G 1/8	M8	-10 to 60
105991	7.DMI.32040	32	40	G 1/8	M8	-10 to 60
105992	7.DMI.32050	32	50	G 1/8	M8	-10 to 60
105993	7.DMI.32060	32	60	G 1/8	M8	-10 to 60
105994	7.DMI.32080	32	80	G 1/8	M8	-10 to 60
105995	7.DMI.40005	40	5	G 1/8	M8	-10 to 60
105996	7.DMI.40010	40	10	G 1/8	M8	-10 to 60
105997	7.DMI.40015	40	15	G 1/8	M8	-10 to 60
105998	7.DMI.40020	40	20	G 1/8	M8	-10 to 60
105999	7.DMI.40025	40	25	G 1/8	M8	-10 to 60
106000	7.DMI.40030	40	30	G 1/8	M8	-10 to 60
106001	7.DMI.40040	40	40	G 1/8	M8	-10 to 60
106002	7.DMI.40050	40	50	G 1/8	M8	-10 to 60
106003	7.DMI.40060	40	60	G 1/8	M8	-10 to 60
106004	7.DMI.40080	40	80	G 1/8	M8	-10 to 60
106005	7.DMI.50005	50	5	G 1/8	M10	-10 to 60
106006	7.DMI.50010	50	10	G 1/8	M10	-10 to 60
106007	7.DMI.50015	50	15	G 1/8	M10	-10 to 60
106008	7.DMI.50020	50	20	G 1/8	M10	-10 to 60



7.DMI.32080

LINER compact cylinders

acc. to ISO 21287 Ø 20 - 100

PLUS

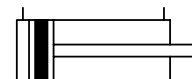

Compact cylinders, double-acting (with magnet), non-cushioned, female piston rod

Art. No.	Type No.	Piston Ø mm	Stroke mm	Connection	Piston rod IT	Temperature range °C
106009	7.DMI.50025	50	25	G 1/8	M10	-10 to 60
106010	7.DMI.50030	50	30	G 1/8	M10	-10 to 60
106011	7.DMI.50040	50	40	G 1/8	M10	-10 to 60
106012	7.DMI.50050	50	50	G 1/8	M10	-10 to 60
106013	7.DMI.50060	50	60	G 1/8	M10	-10 to 60
106014	7.DMI.50080	50	80	G 1/8	M10	-10 to 60
106015	7.DMI.63005	63	5	G 1/8	M10	-10 to 60
106016	7.DMI.63010	63	10	G 1/8	M10	-10 to 60
106017	7.DMI.63015	63	15	G 1/8	M10	-10 to 60
106018	7.DMI.63020	63	20	G 1/8	M10	-10 to 60
106019	7.DMI.63025	63	25	G 1/8	M10	-10 to 60
106020	7.DMI.63030	63	30	G 1/8	M10	-10 to 60
106021	7.DMI.63040	63	40	G 1/8	M10	-10 to 60
106022	7.DMI.63050	63	50	G 1/8	M10	-10 to 60
106023	7.DMI.63060	63	60	G 1/8	M10	-10 to 60
106024	7.DMI.63080	63	80	G 1/8	M10	-10 to 60
106025	7.DMI.80005	80	5	G 1/8	M12	-10 to 80
106026	7.DMI.80010	80	10	G 1/8	M12	-10 to 80
106027	7.DMI.80015	80	15	G 1/8	M12	-10 to 80
106028	7.DMI.80020	80	20	G 1/8	M12	-10 to 80
106029	7.DMI.80025	80	25	G 1/8	M12	-10 to 80
106030	7.DMI.80030	80	30	G 1/8	M12	-10 to 80
106031	7.DMI.80040	80	40	G 1/8	M12	-10 to 80
106032	7.DMI.80050	80	50	G 1/8	M12	-10 to 80
106033	7.DMI.80060	80	60	G 1/8	M12	-10 to 80
106034	7.DMI.80080	80	80	G 1/8	M12	-10 to 80
106035	7.DMI.100005	100	5	G 1/8	M12	-10 to 80
106036	7.DMI.100010	100	10	G 1/8	M12	-10 to 80
106037	7.DMI.100015	100	15	G 1/8	M12	-10 to 80
106038	7.DMI.100020	100	20	G 1/8	M12	-10 to 80
106039	7.DMI.100025	100	25	G 1/8	M12	-10 to 80
106040	7.DMI.100030	100	30	G 1/8	M12	-10 to 80
106041	7.DMI.100040	100	40	G 1/8	M12	-10 to 80
106042	7.DMI.100050	100	50	G 1/8	M12	-10 to 80
106043	7.DMI.100060	100	60	G 1/8	M12	-10 to 80
106044	7.DMI.100080	100	80	G 1/8	M12	-10 to 80



7.DMI.32080

Compact cylinders, double-acting (with magnet), non-cushioned, male piston rod

Art. No.	Type No.	Piston Ø mm	Stroke mm	Connection	Piston rod ET	Temperature range °C
106045	7.DMA.20005	20	5	M5	M8	-10 to 60
106046	7.DMA.20010	20	10	M5	M8	-10 to 60
106047	7.DMA.20015	20	15	M5	M8	-10 to 60
106048	7.DMA.20020	20	20	M5	M8	-10 to 60
106049	7.DMA.20025	20	25	M5	M8	-10 to 60
106050	7.DMA.20030	20	30	M5	M8	-10 to 60
106051	7.DMA.20040	20	40	M5	M8	-10 to 60
106052	7.DMA.20050	20	50	M5	M8	-10 to 60
106053	7.DMA.20060	20	60	M5	M8	-10 to 60
106054	7.DMA.25005	25	5	M5	M8	-10 to 60
106055	7.DMA.25010	25	10	M5	M8	-10 to 60



7.DMA.32080



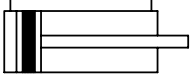

LINER compact cylinders

acc. to ISO 21287 Ø 20 - 100

PLUS



7.DMA.32080

Compact cylinders, double-acting (with magnet), non-cushioned, male piston rod

Art. No.	Type No.	Piston Ø mm	Stroke mm	Connection	Piston rod ET	Temperature range °C
106056	7.DMA.25015	25	15	M5	M8	-10 to 60
106057	7.DMA.25020	25	20	M5	M8	-10 to 60
106058	7.DMA.25025	25	25	M5	M8	-10 to 60
106059	7.DMA.25030	25	30	M5	M8	-10 to 60
106060	7.DMA.25040	25	40	M5	M8	-10 to 60
106061	7.DMA.25050	25	50	M5	M8	-10 to 60
106062	7.DMA.25060	25	60	M5	M8	-10 to 60
106063	7.DMA.32005	32	5	G 1/8	M10x1.25	-10 to 60
106064	7.DMA.32010	32	10	G 1/8	M10x1.25	-10 to 60
106065	7.DMA.32015	32	15	G 1/8	M10x1.25	-10 to 60
106066	7.DMA.32020	32	20	G 1/8	M10x1.25	-10 to 60
106067	7.DMA.32025	32	25	G 1/8	M10x1.25	-10 to 60
106068	7.DMA.32030	32	30	G 1/8	M10x1.25	-10 to 60
106069	7.DMA.32040	32	40	G 1/8	M10x1.25	-10 to 60
106070	7.DMA.32050	32	50	G 1/8	M10x1.25	-10 to 60
106071	7.DMA.32060	32	60	G 1/8	M10x1.25	-10 to 60
106072	7.DMA.32080	32	80	G 1/8	M10x1.25	-10 to 60
106073	7.DMA.40005	40	5	G 1/8	M10x1.25	-10 to 60
106074	7.DMA.40010	40	10	G 1/8	M10x1.25	-10 to 60
106075	7.DMA.40015	40	15	G 1/8	M10x1.25	-10 to 60
106076	7.DMA.40020	40	20	G 1/8	M10x1.25	-10 to 60
106077	7.DMA.40025	40	25	G 1/8	M10x1.25	-10 to 60
106078	7.DMA.40030	40	30	G 1/8	M10x1.25	-10 to 60
106079	7.DMA.40040	40	40	G 1/8	M10x1.25	-10 to 60
106080	7.DMA.40050	40	50	G 1/8	M10x1.25	-10 to 60
106081	7.DMA.40060	40	60	G 1/8	M10x1.25	-10 to 60
106082	7.DMA.40080	40	80	G 1/8	M10x1.25	-10 to 60
106083	7.DMA.50005	50	5	G 1/8	M12x1.25	-10 to 60
106084	7.DMA.50010	50	10	G 1/8	M12x1.25	-10 to 60
106085	7.DMA.50015	50	15	G 1/8	M12x1.25	-10 to 60
106086	7.DMA.50020	50	20	G 1/8	M12x1.25	-10 to 60
106087	7.DMA.50025	50	25	G 1/8	M12x1.25	-10 to 60
106088	7.DMA.50030	50	30	G 1/8	M12x1.25	-10 to 60
106089	7.DMA.50040	50	40	G 1/8	M12x1.25	-10 to 60
106090	7.DMA.50050	50	50	G 1/8	M12x1.25	-10 to 60
106091	7.DMA.50060	50	60	G 1/8	M12x1.25	-10 to 60
106092	7.DMA.50080	50	80	G 1/8	M12x1.25	-10 to 60
106093	7.DMA.63005	63	5	G 1/8	M12x1.25	-10 to 60
106094	7.DMA.63010	63	10	G 1/8	M12x1.25	-10 to 60
106095	7.DMA.63015	63	15	G 1/8	M12x1.25	-10 to 60
106096	7.DMA.63020	63	20	G 1/8	M12x1.25	-10 to 60
106097	7.DMA.63025	63	25	G 1/8	M12x1.25	-10 to 60
106098	7.DMA.63030	63	30	G 1/8	M12x1.25	-10 to 60
106099	7.DMA.63040	63	40	G 1/8	M12x1.25	-10 to 60
106100	7.DMA.63050	63	50	G 1/8	M12x1.25	-10 to 60
106101	7.DMA.63060	63	60	G 1/8	M12x1.25	-10 to 60
106102	7.DMA.63080	63	80	G 1/8	M12x1.25	-10 to 60
106103	7.DMA.80005	80	5	G 1/8	M16x1.5	-10 to 80
106104	7.DMA.80010	80	10	G 1/8	M16x1.5	-10 to 80
106105	7.DMA.80015	80	15	G 1/8	M16x1.5	-10 to 80
106106	7.DMA.80020	80	20	G 1/8	M16x1.5	-10 to 80
106107	7.DMA.80025	80	25	G 1/8	M16x1.5	-10 to 80

LINER compact cylinders

acc. to ISO 21287 Ø 20 - 100

PLUS

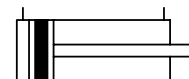

Compact cylinders, double-acting (with magnet), non-cushioned, male piston rod

Art. No.	Type No.	Piston Ø mm	Stroke mm	Connection	Piston rod ET	Temperature range °C
106108	7.DMA.80030	80	30	G 1/8	M16x1.5	-10 to 80
106109	7.DMA.80040	80	40	G 1/8	M16x1.5	-10 to 80
106110	7.DMA.80050	80	50	G 1/8	M16x1.5	-10 to 80
106111	7.DMA.80060	80	60	G 1/8	M16x1.5	-10 to 80
106112	7.DMA.80080	80	80	G 1/8	M16x1.5	-10 to 80
106113	7.DMA.100005	100	5	G 1/8	M16x1.5	-10 to 80
106114	7.DMA.100010	100	10	G 1/8	M16x1.5	-10 to 80
106115	7.DMA.100015	100	15	G 1/8	M16x1.5	-10 to 80
106116	7.DMA.100020	100	20	G 1/8	M16x1.5	-10 to 80
106117	7.DMA.100025	100	25	G 1/8	M16x1.5	-10 to 80
106118	7.DMA.100030	100	30	G 1/8	M16x1.5	-10 to 80
106119	7.DMA.100040	100	40	G 1/8	M16x1.5	-10 to 80
106120	7.DMA.100050	100	50	G 1/8	M16x1.5	-10 to 80
106121	7.DMA.100060	100	60	G 1/8	M16x1.5	-10 to 80
106122	7.DMA.100080	100	80	G 1/8	M16x1.5	-10 to 80



7.DMA.32080

→ Other sizes of fixing parts and accessories can be found in our online shop.

→ Fixing parts and accessories please look at page 390-393

Other types can be supplied at short notice on request:



Single-acting (pressureless in the retracted position), with magnet, non-cushioned (stroke up to 25 mm)



Single-acting (pressureless in the extended position), with magnet, non-cushioned (stroke up to 25 mm)

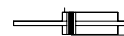

Single or double-acting, with non-rotating rod (also through-rod version), with magnet

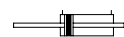

Double-acting with through rod, with magnet, non-cushioned



Single-acting with through rod, with magnet, non-cushioned



Single or double-acting with perforated through rod, with magnet, non-cushioned



Optionally with a flange for assembling two opposing cylinders (multi-position cylinder)

Any non-standard stroke lengths can also be supplied as well as no stick-slip (jerk-free movement < 0.2 m/s).

High-temperature (max. 150 °C) versions.



Fixing parts and accessories for LINER compact cylinders

acc. to ISO 21287 Ø 20 - 100



453.001

Female hinge model, without bushes, with 4 screws, 1 bolt and retainer ring

Art. No.	Type No.	For cylinders	Suitable for piston Ø mm	Material
156658	453.001	ISO 15552, ISO 21287	32	Aluminium
156659	453.002	ISO 15552, ISO 21287	40	Aluminium
156660	453.003	ISO 15552, ISO 21287	50	Aluminium
156661	453.004	ISO 15552, ISO 21287	63	Aluminium
156662	453.005	ISO 15552, ISO 21287	80	Aluminium
156663	453.006	ISO 15552, ISO 21287	100	Aluminium



453.012

Female hinge model, with bushes, with 4 screws, 1 bolt and retainer ring

Art. No.	Type No.	For cylinders	Suitable for piston Ø mm	Material
156669	453.012	ISO 15552, ISO 21287	32	Aluminium
156670	453.013	ISO 15552, ISO 21287	40	Aluminium
156671	453.014	ISO 15552, ISO 21287	50	Aluminium
156672	453.015	ISO 15552, ISO 21287	63	Aluminium
156673	453.016	ISO 15552, ISO 21287	80	Aluminium
156674	453.017	ISO 15552, ISO 21287	100	Aluminium



453.023

Female hinge model, for articulated male hinge model, with 4 screws, 1 bolt and retainer ring

Art. No.	Type No.	For cylinders	Suitable for piston Ø mm	Material
156680	453.023	ISO 15552, ISO 21287	32	Aluminium
156681	453.024	ISO 15552, ISO 21287	40	Aluminium
156682	453.025	ISO 15552, ISO 21287	50	Aluminium
156683	453.026	ISO 15552, ISO 21287	63	Aluminium
156684	453.027	ISO 15552, ISO 21287	80	Aluminium
156685	453.028	ISO 15552, ISO 21287	100	Aluminium



453.044

Male hinge model, without bush, with 4 screws

Art. No.	Type No.	For cylinders	Suitable for piston Ø mm	Material
156778	453.121	ISO 21287 / UNITOP	20 / 20	Aluminium
156779	453.122	ISO 21287 / UNITOP	25 / 25	Aluminium
156701	453.044	ISO 15552, ISO 21287	32	Aluminium
156702	453.045	ISO 15552, ISO 21287	40	Aluminium
156703	453.046	ISO 15552, ISO 21287	50	Aluminium
156704	453.047	ISO 15552, ISO 21287	63	Aluminium
156705	453.048	ISO 15552, ISO 21287	80	Aluminium
156706	453.049	ISO 15552, ISO 21287	100	Aluminium



453.055

Male hinge model with bush, with 4 screws

Art. No.	Type No.	For cylinders	Suitable for piston Ø mm	Material
156781	453.124	ISO 21287 / UNITOP	20 / 20	Aluminium
156782	453.125	ISO 21287 / UNITOP	25 / 25	Aluminium
156712	453.055	ISO 15552, ISO 21287	32	Aluminium
156713	453.056	ISO 15552, ISO 21287	40	Aluminium
156714	453.057	ISO 15552, ISO 21287	50	Aluminium
156715	453.058	ISO 15552, ISO 21287	63	Aluminium
156716	453.059	ISO 15552, ISO 21287	80	Aluminium
156717	453.060	ISO 15552, ISO 21287	100	Aluminium

Fixing parts and accessories for LINER compact cylinders

acc. to ISO 21287 Ø 20 - 100

Counter-hinge model, CETOP RP107P, without screws

Art. No.	Type No.	For cylinders	Suitable for piston Ø mm	Material
156723	453.066	ISO 15552, ISO 21287	32	Aluminium
156724	453.067	ISO 15552, ISO 21287	40	Aluminium
156725	453.068	ISO 15552, ISO 21287	50	Aluminium
156726	453.069	ISO 15552, ISO 21287	63	Aluminium
156727	453.070	ISO 15552, ISO 21287	80	Aluminium
156728	453.071	ISO 15552, ISO 21287	100	Aluminium



453.066

Counter-hinge model for fork model acc. DIN 71752

Art. No.	Type No.	For cylinders	Suitable for piston Ø mm	Material
156733	453.076	ISO 15552, ISO 21287	32	Aluminium
156734	453.077	ISO 15552, ISO 21287	40	Aluminium
156735	453.078	ISO 15552, ISO 21287	50	Aluminium
156736	453.079	ISO 15552, ISO 21287	63	Aluminium
156737	453.080	ISO 15552, ISO 21287	80	Aluminium
156738	453.081	ISO 15552, ISO 21287	100	Aluminium



453.076

Counter-hinge model, CETOP, with 4 screws

Art. No.	Type No.	For cylinders	Suitable for piston Ø mm	Material
106137	437.23-M	ISO 15552, ISO 21287	32	Aluminium
106138	437.24-M	ISO 15552, ISO 21287	40	Aluminium
106139	437.25-M	ISO 15552, ISO 21287	50	Aluminium
106140	437.26-M	ISO 15552, ISO 21287	63	Aluminium
106141	437.27-M	ISO 15552, ISO 21287	80	Aluminium
106142	450.260-M	ISO 15552, ISO 21287	100	Aluminium



437.25-M

Articulated male hinge model, with 4 screws

Art. No.	Type No.	For cylinders	Suitable for piston Ø mm	Material
156743	453.086	ISO 15552, ISO 21287	32	Aluminium
156744	453.087	ISO 15552, ISO 21287	40	Aluminium
156745	453.088	ISO 15552, ISO 21287	50	Aluminium
156746	453.089	ISO 15552, ISO 21287	63	Aluminium
156747	453.090	ISO 15552, ISO 21287	80	Aluminium
156748	453.091	ISO 15552, ISO 21287	100	Aluminium



453.086

Foot model, 1 piece with 2 screws

Art. No.	Type No.	For cylinders	Suitable for piston Ø mm	Material
106123	437.09-M	ISO 21287	20	Steel
106124	437.10-M	ISO 21287	25	Steel
106125	437.14-M	ISO 15552, ISO 21287	32	Steel
106126	450.12-M	ISO 15552, ISO 21287	40	Steel
106127	450.13-M	ISO 15552, ISO 21287	50	Steel
106128	450.14-M	ISO 15552, ISO 21287	63	Steel
106129	450.15-M	ISO 15552, ISO 21287	80	Steel
106130	450.16-M	ISO 15552, ISO 21287	100	Steel



450.12-M

Angle flange, 1 piece with 4 screws

Art. No.	Type No.	For cylinders	Suitable for piston Ø mm	Material
156754	453.097	ISO 15552, ISO 21287	32	Aluminium
156755	453.098	ISO 15552, ISO 21287	40	Aluminium
156756	453.099	ISO 15552, ISO 21287	50	Aluminium
156757	453.100	ISO 15552, ISO 21287	63	Aluminium



453.097

Fixing parts and accessories for LINER compact cylinders

acc. to ISO 21287 Ø 20 - 100



453.100



453.127



GAKAP2M10X125



GEKAP6M10X125



AKM6

Angle flange, 1 piece with 4 screws

Art. No.	Type No.	For cylinders	Suitable for piston Ø mm	Material
156758	453.101	ISO 15552, ISO 21287	80	Aluminium
156759	453.102	ISO 15552, ISO 21287	100	Aluminium

Front or rear flange, with 4 screws

Art. No.	Type No.	For cylinders	Suitable for piston Ø mm	Material
156784	453.127	ISO 21287 / UNITOP	20 / 20	Aluminium
156785	453.128	ISO 21287 / UNITOP	25 / 25	Aluminium

Fork model, with folding spring bolts

Art. No.	Type No.	For cylinders	Suitable for piston Ø mm	Piston rod thread
179920	GAKAP2M8	ISO 6432 ISO 21287	20 20-25	M8x1.25
179921	GAKAP2M10X125	ISO 6432 Round cylinder ISO 21287 ISO 15552	25 32 32-40 32	M10x1.25
179922	GAKAP2M12X125	Round cylinder (not ISO 6432) ISO 21287 ISO 15552	40 50-63 40	M12x1.25
179923	GAKAP2M16X15	Round cylinder (not ISO 6432) ISO 21287 ISO 15552	50 80-100 50-63	M16x1.5

Rod eye model

Art. No.	Type No.	For cylinders	Suitable for piston Ø mm	Piston rod thread
179931	GEKAP6M8	ISO 6432 ISO 21287	20 20-25	M8x1.25
179932	GEKAP6M10X125	ISO 6432 Round cylinder ISO 21287 ISO 15552	25 32 32-40 32	M10x1.25
179933	GEKAP6M12X125	Round cylinder (not ISO 6432) ISO 21287 ISO 15552	40 50-63 40	M12x1.25
179934	GEKAP6M16X15	Round cylinder (not ISO 6432) ISO 21287 ISO 15552	50 80-100 50-63	M16x1.5

Self-aligning rod coupler

Art. No.	Type No.	For cylinders	Suitable for piston Ø mm	Piston rod thread
179942	AKM8	ISO 6432 ISO 21287	20 20-25	M8x1.25
179943	AKM10X125	ISO 6432 Round cylinder / ISO 21287 ISO 15552	25 32 32-40 32	M10x1.25
179944	AKM12X125	Round cylinder (not ISO 6432) ISO 21287 ISO 15552	40 50-63 40	M12x1.25
179945	AKM16X15	Round cylinder (not ISO 6432) ISO 21287 ISO 15552	50 80-100 50-63	M16x1.5

Fixing parts and accessories for LINER compact cylinders

acc. to ISO 21287 Ø 20 - 100

Rod nut

Art. No.	Type No.	For cylinders	Suitable for piston Ø mm	Material	Piston rod thread
105737	436.32-M	ISO 6432 compact cylinders	20 20 - 25	Steel	M8
105738	436.33-M	ISO 6432 compact cyl. standard cyl.	25 32 - 40 32	Steel	M10x1.25
106166	435.82-M	compact cyl. standard cyl.	50 - 63 40	Brass	M12x1.25
106167	435.83-M	compact cyl. standard cyl.	80 - 100 50 - 63	Brass	M16x1.5



436.33-M

Sensor for the T-slots and rectangular slots

Art. No.	Type No.	For cylinders	Description
194356	235.03-M-1	for all cylinders (not for short-stroke cylinders)	REED sensor, 2-wire, with 2.5 m cable length, LED



235.04-M-1

Sensor for the T-slots and rectangular slots

Art. No.	Type No.	For cylinders	Description
194357	235.04-M-1	for all cylinders (not for short-stroke cylinders)	REED sensor, 2-wire, with M8 plug, LED
194358	235.06-M-1	for all cylinders (not for short-stroke cylinders)	HALL sensor, 3-wire, with 2.5 m cable length, PNP, LED
194359	235.07-M-1	for all cylinders (not for short-stroke cylinders)	HALL sensor, 3-wire, with M8 plug, PNP, LED

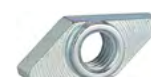

235.11-M

Threaded plate for T-slot, valve assembly directly on the cylinder

Art. No.	Type No.	For cylinders	Material	Description
106168	235.11-M	ISO 21287, ISO 15552	Steel	Threaded plate M4, without screws
106169	235.12-M	ISO 21287, ISO 15552	Steel	Threaded plate M3, without screws
125522	235.05-M	ISO 21287, ISO 15552	Steel	Threaded plate M3/M4



235.05-M

Set of gasket (parts subject to wear)

Art. No.	Type No.	For cylinders	Suitable for piston Ø mm	Material
106170	235.15-M	ISO 21287	20	PU
106171	235.16-M	ISO 21287	25	PU
106172	235.17-M	ISO 21287	32	PU
106173	235.18-M	ISO 21287	40	PU
106174	235.19-M	ISO 21287	50	PU
106175	235.20-M	ISO 21287	63	PU
106176	235.21-M	ISO 21287	80	PU
106177	235.22-M	ISO 21287	100	PU



235.17-M



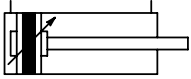

Standard cylinders

acc. to ISO 15552, Ø 32 to 125

These cylinders are ideal for a wide range of applications owing to their robust design and excellent value for money.

The standard type has a double-acting cylinder and features a magnetic piston as well as integrated cushioning. The magnetic switches can be mounted in two T-slots on the same side as the compressed air supply. Suitable for filtered, unlubricated or lubricated compressed air.

If lubrication is used, it must be continuous.

Max. working pressure	10 bar
Temperature range	-10 to 80 °C
Design	Heads / jacket with self-tapping screws
Piston rod	C45 steel, hard chrome-plated
Jacket	Anodised aluminium jacket with integrated T-slots
Sealant	NBR



5.DMD.32250

Standard cylinders, double acting, with magnet, cushioned

Art. No.	Type No.	Piston Ø mm	Stroke mm	Connection	Piston rod ET
106178	5.DMD.32025	32	25	G 1/8	M10x1.25
106179	5.DMD.32050	32	50	G 1/8	M10x1.25
106180	5.DMD.32080	32	80	G 1/8	M10x1.25
106181	5.DMD.32100	32	100	G 1/8	M10x1.25
106182	5.DMD.32125	32	125	G 1/8	M10x1.25
106183	5.DMD.32160	32	160	G 1/8	M10x1.25
106184	5.DMD.32200	32	200	G 1/8	M10x1.25
106185	5.DMD.32250	32	250	G 1/8	M10x1.25
106186	5.DMD.32320	32	320	G 1/8	M10x1.25
106187	5.DMD.32400	32	400	G 1/8	M10x1.25
106188	5.DMD.32500	32	500	G 1/8	M10x1.25
106189	5.DMD.32600	32	600	G 1/8	M10x1.25
106190	5.DMD.32800	32	800	G 1/8	M10x1.25
106191	5.DMD.40025	40	25	G 1/4	M12x1.25
106192	5.DMD.40050	40	50	G 1/4	M12x1.25
106193	5.DMD.40080	40	80	G 1/4	M12x1.25
106194	5.DMD.40100	40	100	G 1/4	M12x1.25
106195	5.DMD.40125	40	125	G 1/4	M12x1.25
106196	5.DMD.40160	40	160	G 1/4	M12x1.25
106197	5.DMD.40200	40	200	G 1/4	M12x1.25
106198	5.DMD.40250	40	250	G 1/4	M12x1.25
106199	5.DMD.40320	40	320	G 1/4	M12x1.25
106200	5.DMD.40400	40	400	G 1/4	M12x1.25
106201	5.DMD.40500	40	500	G 1/4	M12x1.25
106202	5.DMD.40600	40	600	G 1/4	M12x1.25
106203	5.DMD.40800	40	800	G 1/4	M12x1.25
106204	5.DMD.50025	50	25	G 1/4	M16x1.5
106205	5.DMD.50050	50	50	G 1/4	M16x1.5
106206	5.DMD.50080	50	80	G 1/4	M16x1.5
106207	5.DMD.50100	50	100	G 1/4	M16x1.5
106208	5.DMD.50125	50	125	G 1/4	M16x1.5
106209	5.DMD.50160	50	160	G 1/4	M16x1.5
106210	5.DMD.50200	50	200	G 1/4	M16x1.5
106211	5.DMD.50250	50	250	G 1/4	M16x1.5
106212	5.DMD.50320	50	320	G 1/4	M16x1.5
106213	5.DMD.50400	50	400	G 1/4	M16x1.5
106214	5.DMD.50500	50	500	G 1/4	M16x1.5
106215	5.DMD.50600	50	600	G 1/4	M16x1.5
106216	5.DMD.50800	50	800	G 1/4	M16x1.5

Standard cylinders

acc. to ISO 15552, Ø 32 to 125

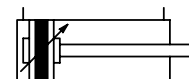
PLUS

Standard cylinders, double acting, with magnet, cushioned

Art. No.	Type No.	Piston Ø mm	Stroke mm	Connection	Piston rod ET
106217	5.DMD.63025	63	25	G 3/8	M16x1.5
106218	5.DMD.63050	63	50	G 3/8	M16x1.5
106219	5.DMD.63080	63	80	G 3/8	M16x1.5
106220	5.DMD.63100	63	100	G 3/8	M16x1.5
106221	5.DMD.63125	63	125	G 3/8	M16x1.5
106222	5.DMD.63160	63	160	G 3/8	M16x1.5
106223	5.DMD.63200	63	200	G 3/8	M16x1.5
106224	5.DMD.63250	63	250	G 3/8	M16x1.5
106225	5.DMD.63320	63	320	G 3/8	M16x1.5
106226	5.DMD.63400	63	400	G 3/8	M16x1.5
106227	5.DMD.63500	63	500	G 3/8	M16x1.5
106228	5.DMD.63600	63	600	G 3/8	M16x1.5
106229	5.DMD.63800	63	800	G 3/8	M16x1.5
106230	5.DMD.80025	80	25	G 3/8	M20x1.5
106231	5.DMD.80050	80	50	G 3/8	M20x1.5
106232	5.DMD.80080	80	80	G 3/8	M20x1.5
106233	5.DMD.80100	80	100	G 3/8	M20x1.5
106234	5.DMD.80125	80	125	G 3/8	M20x1.5
106235	5.DMD.80160	80	160	G 3/8	M20x1.5
106236	5.DMD.80200	80	200	G 3/8	M20x1.5
106237	5.DMD.80250	80	250	G 3/8	M20x1.5
106238	5.DMD.80320	80	320	G 3/8	M20x1.5
106239	5.DMD.80400	80	400	G 3/8	M20x1.5
106240	5.DMD.80500	80	500	G 3/8	M20x1.5
106241	5.DMD.80600	80	600	G 3/8	M20x1.5
106242	5.DMD.80800	80	800	G 3/8	M20x1.5
106243	5.DMD.100025	100	25	G 1/2	M20x1.5
106244	5.DMD.100050	100	50	G 1/2	M20x1.5
106245	5.DMD.100080	100	80	G 1/2	M20x1.5
106246	5.DMD.100100	100	100	G 1/2	M20x1.5
106247	5.DMD.100125	100	125	G 1/2	M20x1.5
106248	5.DMD.100160	100	160	G 1/2	M20x1.5
106249	5.DMD.100200	100	200	G 1/2	M20x1.5
106250	5.DMD.100250	100	250	G 1/2	M20x1.5
106251	5.DMD.100320	100	320	G 1/2	M20x1.5
106252	5.DMD.100400	100	400	G 1/2	M20x1.5
106253	5.DMD.100500	100	500	G 1/2	M20x1.5
106254	5.DMD.100600	100	600	G 1/2	M20x1.5
106255	5.DMD.100800	100	800	G 1/2	M20x1.5
106256	5.DMD.125025	125	25	G 1/2	M27x2
106257	5.DMD.125050	125	50	G 1/2	M27x2
106258	5.DMD.125080	125	80	G 1/2	M27x2
106259	5.DMD.125100	125	100	G 1/2	M27x2
106260	5.DMD.125125	125	125	G 1/2	M27x2
106261	5.DMD.125160	125	160	G 1/2	M27x2
106262	5.DMD.125200	125	200	G 1/2	M27x2
106263	5.DMD.125250	125	250	G 1/2	M27x2
106264	5.DMD.125320	125	320	G 1/2	M27x2



5.DMD.32250



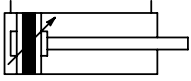

Standard cylinders

acc. to ISO 15552, Ø 32 to 125

PLUS

Standard cylinders, double acting, with magnet, cushioned

Art. No.	Type No.	Piston Ø mm	Stroke mm	Connection	Piston rod ET
106265	5.DMD.125400	125	400	G 1/2	M27x2
106266	5.DMD.125500	125	500	G 1/2	M27x2
106267	5.DMD.125600	125	600	G 1/2	M27x2
106268	5.DMD.125800	125	800	G 1/2	M27x2

- ➔ Other sizes of fixing parts and accessories can be found in our online shop.
- ➔ Fixing parts and accessories please look at page 307-402



5.DMD.32250

Other types can be supplied at short notice on request:



Single-acting (pressureless in the retracted position), with magnet, non-cushioned (diameter up to Ø 63 and stroke up to 250 mm)

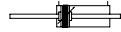

Double-acting with through rod, with magnet, cushioned



Tandem cylinder, double-acting, with magnet, cushioned



Multi-position cylinder comprised of two opposing cylinders, with magnet, cushioned



Double-acting, with magnet, non-cushioned



Cylinder with integrated hydraulic brake, pressureless – immovable rod, with magnet, cushioned

Any non-standard stroke lengths can also be supplied as well as no stick-slip (jerk-free movement < 0.2 m/s), high-temperature (max. 150 °C) and low-temperature (min. -35 °C) versions

Guide units in various designs for absorbing high lateral forces are available for all Ø 32 to Ø 100 standard cylinders

The features cannot be combined arbitrarily.

Fixing parts and accessories for standard cylinders

nach ISO 15552, Ø 32 - 125

Female hinge model, without bushes, with 4 screws, 1 bolt and retainer ring

Art. No.	Type No.	For cylinders	Suitable for piston Ø mm	Material
156658	453.001	ISO 15552, ISO 21287	32	Aluminium
156659	453.002	ISO 15552, ISO 21287	40	Aluminium
156660	453.003	ISO 15552, ISO 21287	50	Aluminium
156661	453.004	ISO 15552, ISO 21287	63	Aluminium
156662	453.005	ISO 15552, ISO 21287	80	Aluminium
156663	453.006	ISO 15552, ISO 21287	100	Aluminium
156664	453.007	ISO 15552, ISO 21287	125	Aluminium



453.001

Female hinge model, with bushes, with 4 screws, 1 bolt and retainer ring

Art. No.	Type No.	For cylinders	Suitable for piston Ø mm	Material
156669	453.012	ISO 15552, ISO 21287	32	Aluminium
156670	453.013	ISO 15552, ISO 21287	40	Aluminium
156671	453.014	ISO 15552, ISO 21287	50	Aluminium
156672	453.015	ISO 15552, ISO 21287	63	Aluminium
156673	453.016	ISO 15552, ISO 21287	80	Aluminium
156674	453.017	ISO 15552, ISO 21287	100	Aluminium
156675	453.018	ISO 15552, ISO 21287	125	Aluminium



453.012

Female hinge model, for articulated male hinge model, with 4 screws, 1 bolt and retainer ring

Art. No.	Type No.	For cylinders	Suitable for piston Ø mm	Material
156680	453.023	ISO 15552, ISO 21287	32	Aluminium
156681	453.024	ISO 15552, ISO 21287	40	Aluminium
156682	453.025	ISO 15552, ISO 21287	50	Aluminium
156683	453.026	ISO 15552, ISO 21287	63	Aluminium
156684	453.027	ISO 15552, ISO 21287	80	Aluminium
156685	453.028	ISO 15552, ISO 21287	100	Aluminium
156686	453.029	ISO 15552, ISO 21287	125	Aluminium



453.023



Male hinge model, without bush, with 4 screws

Art. No.	Type No.	For cylinders	Suitable for piston Ø mm	Material
156701	453.044	ISO 15552, ISO 21287	32	Aluminium
156702	453.045	ISO 15552, ISO 21287	40	Aluminium
156703	453.046	ISO 15552, ISO 21287	50	Aluminium
156704	453.047	ISO 15552, ISO 21287	63	Aluminium
156705	453.048	ISO 15552, ISO 21287	80	Aluminium
156706	453.049	ISO 15552, ISO 21287	100	Aluminium
156707	453.050	ISO 15552, ISO 21287	125	Aluminium



453.044

Male hinge model with bush, with 4 screws

Art. No.	Type No.	For cylinders	Suitable for piston Ø mm	Material
156712	453.055	ISO 15552, ISO 21287	32	Aluminium
156713	453.056	ISO 15552, ISO 21287	40	Aluminium
156714	453.057	ISO 15552, ISO 21287	50	Aluminium
156715	453.058	ISO 15552, ISO 21287	63	Aluminium
156716	453.059	ISO 15552, ISO 21287	80	Aluminium
156717	453.060	ISO 15552, ISO 21287	100	Aluminium
156718	453.061	ISO 15552, ISO 21287	125	Aluminium



453.055

Fixing parts and accessories for standard cylinders

acc. to ISO 15552, Ø 32 to 125



453.066

Counter-hinge model, CETOP RP107P, without screws

Art. No.	Type No.	For cylinders	Suitable for piston Ø mm	Material
156723	453.066	ISO 15552, ISO 21287	32	Aluminium
156724	453.067	ISO 15552, ISO 21287	40	Aluminium
156725	453.068	ISO 15552, ISO 21287	50	Aluminium
156726	453.069	ISO 15552, ISO 21287	63	Aluminium
156727	453.070	ISO 15552, ISO 21287	80	Aluminium
156728	453.071	ISO 15552, ISO 21287	100	Aluminium
156729	453.072	ISO 15552, ISO 21287	125	Aluminium



453.076

Counter-hinge model, CETOP RP107P, for fork model acc. DIN 71752

Art. No.	Type No.	For cylinders	Suitable for piston Ø mm	Material
156733	453.076	ISO 15552, ISO 21287	32	Aluminium
156734	453.077	ISO 15552, ISO 21287	40	Aluminium
156735	453.078	ISO 15552, ISO 21287	50	Aluminium
156736	453.079	ISO 15552, ISO 21287	63	Aluminium
156737	453.080	ISO 15552, ISO 21287	80	Aluminium
156738	453.081	ISO 15552, ISO 21287	100	Aluminium
156739	453.082	ISO 15552, ISO 21287	125	Aluminium



437.25-M

Counter-hinge model, CETOP, with 4 screws

Art. No.	Type No.	For cylinders	Suitable for piston Ø mm	Material
106137	437.23-M	ISO 15552, ISO 21287	32	Aluminium
106138	437.24-M	ISO 15552, ISO 21287	40	Aluminium
106139	437.25-M	ISO 15552, ISO 21287	50	Aluminium
106140	437.26-M	ISO 15552, ISO 21287	63	Aluminium
106141	437.27-M	ISO 15552, ISO 21287	80	Aluminium
106142	450.260-M	ISO 15552, ISO 21287	100	Aluminium
106271	450.270-M	ISO 15552, ISO 21287	125	Aluminium



453.086

Articulated male hinge model, with 4 screws

Art. No.	Type No.	For cylinders	Suitable for piston Ø mm	Material
156743	453.086	ISO 15552, ISO 21287	32	Aluminium
156744	453.087	ISO 15552, ISO 21287	40	Aluminium
156745	453.088	ISO 15552, ISO 21287	50	Aluminium
156746	453.089	ISO 15552, ISO 21287	63	Aluminium
156747	453.090	ISO 15552, ISO 21287	80	Aluminium
156748	453.091	ISO 15552, ISO 21287	100	Aluminium
156749	453.092	ISO 15552, ISO 21287	125	Aluminium

Fixing parts and accessories for standard cylinders

acc. to ISO 15552, Ø 32 to 125

Foot model, 1 piece with 2 screws

Art. No.	Type No.	For cylinders	Suitable for piston Ø mm	Material
106125	437.14-M	ISO 15552, ISO 21287	32	Steel
106126	450.12-M	ISO 15552, ISO 21287	40	Steel
106127	450.13-M	ISO 15552, ISO 21287	50	Steel
106128	450.14-M	ISO 15552, ISO 21287	63	Steel
106129	450.15-M	ISO 15552, ISO 21287	80	Steel
106130	450.16-M	ISO 15552, ISO 21287	100	Steel
106269	450.17-M	ISO 15552, ISO 21287	125	Steel



450.12-M

Angle flange, 1 piece with 4 screws

Art. No.	Type No.	For cylinders	Suitable for piston Ø mm	Material
156754	453.097	ISO 15552, ISO 21287	32	Aluminium
156755	453.098	ISO 15552, ISO 21287	40	Aluminium
156756	453.099	ISO 15552, ISO 21287	50	Aluminium
156757	453.100	ISO 15552, ISO 21287	63	Aluminium
156758	453.101	ISO 15552, ISO 21287	80	Aluminium
156759	453.102	ISO 15552, ISO 21287	100	Aluminium
156760	453.103	ISO 15552, ISO 21287	125	Aluminium



453.097

Front or rear flange, with 4 screws

Art. No.	Type No.	For cylinders	Suitable for piston Ø mm
106159	437.04-M	ISO 15552, ISO 21287	32
106160	450.020-M	ISO 15552, ISO 21287	40
106161	450.030-M	ISO 15552, ISO 21287	50
106162	450.040-M	ISO 15552, ISO 21287	63
106163	450.050-M	ISO 15552, ISO 21287	80
106164	450.060-M	ISO 15552, ISO 21287	100
106274	450.070-M	ISO 15552, ISO 21287	125



450.020-M

Fork model, with folding spring bolts

Art. No.	Type No.	For cylinders	Suitable for piston Ø mm	Piston rod thread
179921	GAKAP2M10X125	ISO 6432	25	M10x1.25
		Round cylinder	32	
		ISO 21287	32-40	
179922	GAKAP2M12X125	ISO 15552	32	M12x1.25
		Round cylinder (not ISO 6432)	40	
		ISO 21287	50-63	
179923	GAKAP2M16X15	ISO 15552	40	M16x1.5
		Round cylinder (not ISO 6432)	50	
		ISO 21287	80-100	
179924	GAKAP2M20X15	ISO 15552	50-63	M20x1.5
		ISO 21287	125	
179925	GAKAP2M27X2	ISO 15552	80-100	M27x2
			125	



GAKAP2M10X125



GAKAP2M27X2



Fixing parts and accessories for standard cylinders

acc. to ISO 15552, Ø 32 to 125



GEKAP6M10X125

Rod eye model

Art. No.	Type No.	For cylinders	Suitable for piston Ø mm	Piston rod thread
179932	GEKAP6M10X125	ISO 6432 Round cylinder ISO 21287 ISO 15552	25 32 32-40 32	M10x1.25
179933	GEKAP6M12X125	Round cylinder (not ISO 6432) ISO 21287 ISO 15552	40 50-63 40	M12x1.25
179934	GEKAP6M16X15	Round cylinder (not ISO 6432) ISO 21287 ISO 15552	50 80-100 50-63	M16x1.5
179935	GEKAP6M20X15	ISO 21287 ISO 15552	125 80-100	M20x1.5
179936	GEKAP6M27X2	ISO 15552	125	M27x2



AKM10X125

Self-aligning rod coupler

Art. No.	Type No.	For cylinders	Suitable for piston Ø mm	Piston rod thread
179943	AKM10X125	ISO 6432 Round cylinder ISO 21287 ISO 15552	25 32 32-40 32	M10x1.25
179944	AKM12X125	Round cylinder (not ISO 6432) ISO 21287 ISO 15552	40 50-63 40	M12x1.25
179945	AKM16X15	Round cylinder (not ISO 6432) ISO 21287 ISO 15552	50 80-100 50-63	M16x1.5
179946	AKM20X15	ISO 21287 ISO 15552	125 80-100	M20x1.5
179947	AKM27X2	ISO 15552	125	M27x2



436.33-M

Rod nut

Art. No.	Type No.	For cylinders	Suitable for piston Ø mm	Material	Piston rod thread
105738	436.33-M	ISO 6432 compact cylinder standard cylinder	25 32 - 40 32	Steel	M10x1.25
106166	435.82-M	compact cylinder standard cylinder	50 - 63 40	Brass	M12x1.25
106167	435.83-M	compact cylinder standard cylinder	80 - 100 50 - 63	Brass	M16x1.5
106283	450.84-M	Standard cylinder	80 - 100	Steel	M20x1.5
106284	450.85-M	Standard cylinder	125	Steel	M27x2

Fixing parts and accessories for standard cylinders

acc. to ISO 15552, Ø 32 to 125

Sensor for the T-slots and rectangular slots				
Art. No.	Type No.	For cylinders	Description	
194356	235.03-M-1	for all cylinders (not for short-stroke cylinders)	REED sensor, 2-wire, with 2.5 m cable length, LED	
194357	235.04-M-1	for all cylinders (not for short-stroke cylinders)	REED sensor, 2-wire, with M8 plug, LED	
194358	235.06-M-1	for all cylinders (not for short-stroke cylinders)	HALL sensor, 3-wire, with 2.5 m cable length, PNP, LED	
194359	235.07-M-1	for all cylinders (not for short-stroke cylinders)	HALL sensor, 3-wire, with M8 plug, PNP, LED	



235.04-M-1

Threaded plate for T-slot, valve assembly directly on the cylinder				
Art. No.	Type No.	For cylinders	Material	Description
106168	235.11-M	ISO 21287, ISO 15552	Steel	Threaded plate M4, without screws
106169	235.12-M	ISO 21287, ISO 15552	Steel	Threaded plate M3, without screws
125522	235.05-M	ISO 21287, ISO 15552	Steel	Threaded plate M3/M4

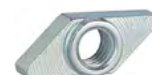

235.11-M



235.05-M

Bar for grooving, 1 piece 500 mm					
Art. No.	Type No.	For cylinders	Suitable for piston Ø mm	Material	Description
106384	455.06-M	Standard cylinder rodless cylinder	32-125 32-63	PVC	For closing the T-slot and possibly the sensor cable guide



455.06-M



Fixing parts and accessories for standard cylinders

acc. to ISO 15552, Ø 32 to 125



235.29-M



236.29-M

Set of gasket (parts subject to wear)

Art. No.	Type No.	For cylinders	Suitable for piston Ø mm	Material
106285	235.23-M	Standard cylinder	32	NBR
106286	235.24-M	Standard cylinder	40	NBR
106287	235.25-M	Standard cylinder	50	NBR
106288	235.26-M	Standard cylinder	63	NBR
106289	235.27-M	Standard cylinder	80	NBR
106290	235.28-M	Standard cylinder	100	NBR
106291	235.29-M	Standard cylinder	125	NBR
106292	236.23-M	Standard cylinder	32	PU
106293	236.24-M	Standard cylinder	40	PU
106294	236.25-M	Standard cylinder	50	PU
106295	236.26-M	Standard cylinder	63	PU
106296	236.27-M	Standard cylinder	80	PU
106297	236.28-M	Standard cylinder	100	PU
106298	236.29-M	Standard cylinder	125	PU

Rodless cylinders

ZRL1 series

PLUS

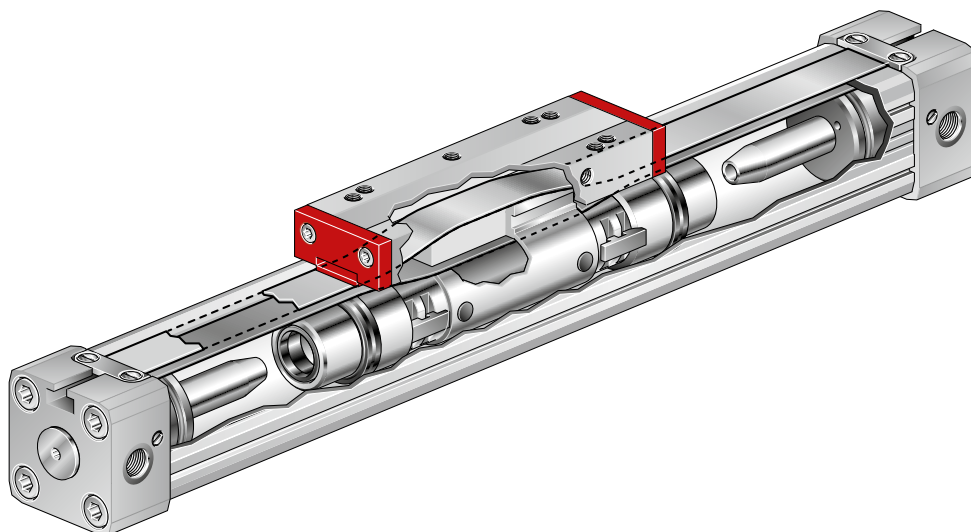

ZRL1C series
Classic design with high carriage



ZRL1F series
Compact design with low carriage



ZRL1S series
With integrated sliding guide

Other designs with different guides or as duo assembly on request.

Features:

- Equal forces in both directions
- Direct force output, protected against rotation
- Particularly space-saving – installation length halved compared to cylinders with piston rod
- Extreme stroke lengths up to 5,700 mm
- End caps with three air connections and adjustable cushioning
- High acceleration and velocity
- High degree of design freedom

Application examples:

- For linear and direct horizontal, vertical and diagonal load movements
- Can be used as a self-supporting structural or pure load-bearing machine element in single, multiple or parallel axis arrangement
- Suitable for conveyor systems, packaging and filling systems, handling systems, workpiece transport systems, door closing systems, etc.

Delivery times, freight and packaging costs:

- After receipt of order, the cylinders will be manufactured individually for you.
- Usually, shipment takes place within 5 working days, depending on the number of pieces.
- Freight and packaging costs are charged individually and regardless of the value of the goods.



ZRL1C series

PLUS



ZRL1C series actuators include piston diameters of 16, 25, 32 and 40 mm with stroke lengths up to 5,700 mm.

Suitable for filtered (50 µm) and unlubricated or lubricated compressed air.

Please ensure continuous oiling when using lubricated compressed air.

Please refer to our type code for the available variants and their corresponding type designations for your individual inquiry. Other special designs are also available on request.

Suitable for use in EX areas – ATEX

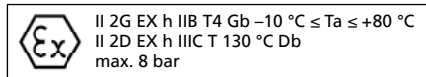

Working pressure:	0.5–8 bar
Temperature range:	-10 °C to 80 °C
Barrel, end caps and piston axle:	High-strength anodized aluminum
Seals:	Oil proof synthetic material (NBR/FPM)
Sealing bands:	Stainless steel
Piston caps and sliding parts:	Abrasion-resistant plastic

Example:

ZRL1C.250250.KBWF.LL.N.EX

Piston Ø [mm]	Stroke min.–max. [mm]	Variant	Lubrication	Magnet	ATEX
16	0100 ... 4400 (Ø 16)	Standard: - Rigid load connection - Screws 10.9 zinc plated - 3 air connections - NBR seals For speeds ≤ 1 m/s.	Standard lubrication LL Slow speed lubrication Recommended for speeds ≤ 0,1m/s (NBR seals)/ ≤ 0,2m/s (FPM seals).	Standard: with magnet N without magnet	Standard: no EX yes
25	0100 ... 5700 (Ø 25, 32, 40)				
32					
40					
			SX Same as standard, except: ⊕ Stainless steel screws		
		F Same as standard, except: ⊕ FPM seals For speeds >1 m/s, at which the seals are exposed to increased temperature development.			
		SXF Same as standard, except: ⊕ Stainless steel screws ⊕ FPM seals For speeds >1 m/s.			
		KBW Same as standard, except: ⊕ Flexible load connection			
		KBWF Same as standard, except: ⊕ Flexible load connection ⊕ FPM seals For speeds >1 m/s.			

→ For each position in the type code, only one option can be selected by default.

Piston Ø and stroke must always be defined as the minimum specification, e. g. ZRL1C.320100.

→ Standard options are not explicitly defined, meaning the position in the type code remains empty, e. g. ZRL1C.320100.LL.

ZRL1F series

PLUS



ZRL1F series actuators feature a particularly flat carriage design and include piston diameters of 16, 25, 32, 40, 50 and 63 mm with stroke lengths up to 5,700 mm. Suitable for filtered (50 µm) and unlubricated or lubricated compressed air. Please ensure continuous oiling when using lubricated compressed air.

Please refer to our type code for the available variants and their corresponding type designations for your individual inquiry. Other special designs are also available on request.

An articulated carrier is available as a separate accessory.

Suitable for use in EX areas – ATEX

	II 2G EX h IIB T4 Gb -10 °C ≤ Ta ≤ +80 °C
	II 2D EX h IIIC T 130 °C Db
	max. 8 bar

Working pressure:	0.5–8 bar
Temperature range:	-10 °C to 80 °C
Barrel, end caps and piston axle:	High-strength anodized aluminum
Seals:	Oil proof synthetic material (NBR/FPM)
Sealing bands:	Stainless steel
Piston caps and sliding parts:	Abrasion-resistant plastic

Example:

ZRL1F.250250.KBWF.LL.N.EX

Piston Ø [mm]	Stroke min.–max. [mm]	Variant	Lubrication	Magnet	ATEX
16	0100 ... 4400 (Ø 16)	Standard: - Rigid load connection - Screws 10.9 zinc plated - 3 air connections - NBR seals For speeds ≤1 m/s.	Standard lubrication LL Slow speed lubrication Recommended for speeds ≤ 0,1m/s (NBR seals)/ ≤ 0,2m/s (FPM seals).	Standard: with magnet N without magnet	Standard: no EX yes
25	0100 ... 5700 (Ø 25, 32, 40, 50, 63)				
32					
40					
50					
63					
		SX Same as standard, except: ⊕ Stainless steel screws			
		F Same as standard, except: ⊕ FPM seals For speeds >1 m/s, at which the seals are exposed to increased temperature development.			
		SXF Same as standard, except: ⊕ Stainless steel screws ⊕ FPM seals For speeds >1 m/s.			
		LE Same as standard, except: ⊕ Air supply from one side (only for Ø 32, 40, 50, 63)			
		KBW Same as standard, except: ⊕ Flexible load connection			
		KBWF Same as standard, except: ⊕ Flexible load connection ⊕ FPM seals For speeds >1 m/s.			

- ➔ For each position in the type code, only one option can be selected by default.
- Piston Ø and stroke must always be defined as the minimum specification, e. g. ZRL1F.320100.
- ➔ Standard options are not explicitly defined, meaning the position in the type code remains empty, e. g. ZRL1F.320100.LL.

ZRL1S series

PLUS |



ZRL1S series actuators feature an integrated plastic sliding guide and include piston diameters of 32, 40, 50 and 63 mm with stroke lengths up to 5,700 mm. Suitable for filtered (50 µm) and unlubricated or lubricated compressed air. Please ensure continuous oiling when using oiled compressed air.

The integrated sliding guide allows higher loads and makes the cylinders less sensitive to moisture, dirt and shocks.

Please refer to our type code for the available variants and their corresponding type designations for your individual inquiry. Other special designs are also available on request.

Working pressure:	0.5–8 bar
Temperature range:	–10 °C to 55 °C
Barrel, end caps and piston axle:	High-strength anodized aluminum
Seals:	Oil proof synthetic material (NBR/FPM)
Sealing bands:	Stainless steel
Piston caps and sliding parts:	Abrasion-resistant plastic

Example:

ZRL1S.250250.KBWF.LL

Piston Ø [mm]	Stroke min.–max. [mm]	Variant	Lubrication
32	0100 ... 5700 (Ø 32, 40, 50, 63)	Standard: - Rigid load connection - Screws 10.9 zinc plated - 3 air connections - NBR seals For speeds ≤1 m/s.	Standard lubrication
40			LL Slow speed lubrication
50			Recommended for speeds ≤ 0,1 m/s (NBR seals)/ ≤ 0,2 m/s (FPM seals).
63			
		SX Same as standard, except: ⊕ Stainless steel screws	
		F Same as standard, except: ⊕ FPM seals For speeds >1 m/s, at which the seals are exposed to increased temperature development.	
		SXF Same as standard, except: ⊕ Stainless steel screws ⊕ FPM seals For speeds >1 m/s.	
		LE Same as standard, except: ⊕ Air supply from one side	

- For each position in the type code, only one option can be selected by default. Piston Ø and stroke must always be defined as the minimum specification, e. g. ZRL1S.320100.
- Standard options are not explicitly defined, meaning the position in the type code remains empty, e. g. ZRL1S.320100.LL.

NEW Fixing parts and accessories for rodless cylinders

ZRL1 series

Foot model, 2 pieces with 4 screws				
Art. No.	Type No.	For cylinders	Suitable for piston Ø mm	Material
129640	FB.ZRL1.16	ZRL1C, ZRL1F, ZRL1S	16	Aluminium
129641	FB.ZRL1.25	ZRL1C, ZRL1F, ZRL1S	25	Aluminium
129642	FB.ZRL1.32	ZRL1C, ZRL1F, ZRL1S	32	Aluminium
129643	FB.ZRL1.32V	ZRL1C, ZRL1F, ZRL1S	32	Aluminium
129644	FB.ZRL1.40	ZRL1C, ZRL1F, ZRL1S	40	Aluminium
129645	FB.ZRL1.50	ZRL1C, ZRL1F, ZRL1S	50	Aluminium
129646	FB.ZRL1.63	ZRL1C, ZRL1F, ZRL1S	63	Aluminium



FB.ZRL1.25

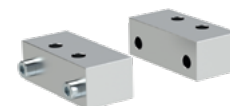

FB.ZRL1.32

Mid section support, 2 pieces				
Art. No.	Type No.	For cylinders	Suitable for piston Ø mm	Material
129647	ZS.ZRL1.16	ZRL1C, ZRL1F, ZRL1S	16	Aluminium
129648	ZS.ZRL1.25	ZRL1C, ZRL1F, ZRL1S	25	Aluminium



ZS.ZRL1.25

Mid section mounting, 2 pieces with 4 screws and 4 slot nuts				
Art. No.	Type No.	For cylinders	Suitable for piston Ø mm	Material
129649	MB.ZRL1C-F-S.32	ZRL1C, ZRL1F, ZRL1S	32	Aluminium
129650	MB.ZRL1C-F-S.40	ZRL1C, ZRL1F, ZRL1S	40	Aluminium
129651	MB.ZRL1.50	ZRL1C, ZRL1F, ZRL1S	50	Aluminium
129652	MB.ZRL1.63	ZRL1C, ZRL1F, ZRL1S	63	Aluminium



MB.ZRL1C-F-S.40



Mobile mid section mounting, 1 piece with 2 screws				
Art. No.	Type No.	For cylinders	Suitable for piston Ø mm	Material
129653	MMBG.ZRL1.16	ZRL1C, ZRL1F, ZRL1S	16	Aluminium
129654	MMBG.ZRL1.25	ZRL1C, ZRL1F, ZRL1S	25	Aluminium
129655	MMBW.ZRL1.16	ZRL1C, ZRL1F, ZRL1S	16	Aluminium
129656	MMBW.ZRL1.25	ZRL1C, ZRL1F, ZRL1S	25	Aluminium



MMBG.ZRL1.16



MMBW.ZRL1.16

NEW Fixing parts and accessories for rodless cylinders

ZRL1 series



KBW.ZRL1C.40

Articulated carrier, 1 piece incl. bolt

Art. No.	Type No.	For cylinders	Suitable for piston Ø mm
129657	KBW.ZRL1C.16	ZRL1C	16
129658	KBW.ZRL1C.25	ZRL1C	25
129659	KBW.ZRL1C.32	ZRL1C	32
129660	KBW.ZRL1C.40	ZRL1C	40



KBW.ZRL1F.16

Articulated carrier, 1 piece with 4 screws and 4 washers

Art. No.	Type No.	For cylinders	Suitable for piston Ø mm
129661	KBW.ZRL1F.16	ZRL1F	16
129662	KBW.ZRL1F.25	ZRL1F	25
129663	KBW.ZRL1F.32	ZRL1F	32
129664	KBW.ZRL1F.40	ZRL1F	40
129665	KBW.ZRL1F.50	ZRL1F	50
129666	KBW.ZRL1F.63	ZRL1F	63



AP.ZRL1F.63

Profile increase adapter plate, 1 piece with 4 screws and 4 washers

Art. No.	Type No.	For cylinders	Suitable for piston Ø mm	Material
129667	AP.ZRL1F.63	ZRL1F	63	Aluminium



SA.ZRL1.16-40

T-slot sensor adapter

Art. No.	Type No.	For cylinders	Suitable for piston Ø mm	Material	Description
129668	SA.ZRL1.16-40	ZRL1C, ZRL1F, ZRL1S	16 to 40	Aluminium	for mounting the sensor on the cylinder



SK.M8.5

Sensor cable

Art. No.	Type No.	Material	Description
129669	SK.M8.5	Aluminium	Sensor cable with M8 connector, straight, 5m, PVC

NEW Fixing parts and accessories for rodless cylinders

ZRL1 series

Sensors			
Art. No.	Type No.	For cylinders	Description
129638	RS.ZRL1.K5	ZRL1C, ZRL1F, ZRL1S	REED sensor, 5 m cable with open strands, 5-130V AC/DC, 6W, NO, LED
129639	HS.ZRL1.PNP.M8	ZRL1C, ZRL1F, ZRL1S	HALL sensor, M8 connector, 300 mm cable, 10-30V DC, 4W, NO, PNP, LED



RS.ZRL1.K5



HS.ZRL1.PNP.M8



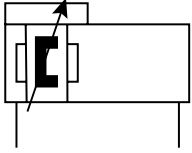

Rodless cylinders

6.DD series Ø 16 to 63

PLUS

These double-acting cylinders can also be supplied with strokes greater than 5 m, providing the stroke length is approximately equal to the overall length. They are equipped with magnets as standard for indicating the position as well as pneumatic, adjustable end position cushioning. Limit switches and hydraulic shock absorbers can be mounted as add-on modules. Suitable for filtered (50 µm), unlubricated or lubricated compressed air. If lubrication is used, it must be continuous.

Working pressure	1 - 8 bar
Temperature range	-10 to 80 °C
Housing	Jacket made from anodised aluminium alloy
Slide (piston guide)	Anodised aluminium alloy
Sealing bands	Stainless steel
Sealant	NBR (for speeds up to 1 m/s)

Rodless cylinders, double-acting, magnetic, pneumatic cushioning

Art. No.	Type No.	Piston Ø mm	Stroke mm	Connection	Force at 6 bar N	Max. lateral load Nm
106299	6.DD.160100	16	100	M5	110	0.3
106300	6.DD.160200	16	200	M5	110	0.3
106301	6.DD.160300	16	300	M5	110	0.3
106302	6.DD.160400	16	400	M5	110	0.3
106303	6.DD.160500	16	500	M5	110	0.3
106304	6.DD.160600	16	600	M5	110	0.3
106305	6.DD.160700	16	700	M5	110	0.3
106306	6.DD.160800	16	800	M5	110	0.3
106307	6.DD.160900	16	900	M5	110	0.3
106308	6.DD.161000	16	1000	M5	110	0.3
106309	6.DD.161200	16	1200	M5	110	0.3
106310	6.DD.161400	16	1400	M5	110	0.3
106311	6.DD.162000	16	2000	M5	110	0.3
106312	6.DD.250100	25	100	G 1/8	250	1
106313	6.DD.250200	25	200	G 1/8	250	1
106314	6.DD.250300	25	300	G 1/8	250	1
106315	6.DD.250400	25	400	G 1/8	250	1
106316	6.DD.250500	25	500	G 1/8	250	1
106317	6.DD.250600	25	600	G 1/8	250	1
106318	6.DD.250700	25	700	G 1/8	250	1
106319	6.DD.250800	25	800	G 1/8	250	1
106320	6.DD.250900	25	900	G 1/8	250	1
106321	6.DD.251000	25	1000	G 1/8	250	1
106322	6.DD.251200	25	1200	G 1/8	250	1
106323	6.DD.251400	25	1400	G 1/8	250	1
106324	6.DD.252000	25	2000	G 1/8	250	1
106325	6.DD.320100	32	100	G 1/4	420	2
106326	6.DD.320200	32	200	G 1/4	420	2
106327	6.DD.320300	32	300	G 1/4	420	2
106328	6.DD.320400	32	400	G 1/4	420	2
106329	6.DD.320500	32	500	G 1/4	420	2
106330	6.DD.320600	32	600	G 1/4	420	2
106331	6.DD.320700	32	700	G 1/4	420	2
106332	6.DD.320800	32	800	G 1/4	420	2
106333	6.DD.320900	32	900	G 1/4	420	2
106334	6.DD.321000	32	1000	G 1/4	420	2
106335	6.DD.321200	32	1200	G 1/4	420	2
106336	6.DD.321400	32	1400	G 1/4	420	2
106337	6.DD.322000	32	2000	G 1/4	420	2
106338	6.DD.400100	40	100	G 1/4	640	4
106339	6.DD.400200	40	200	G 1/4	640	4



6.DD.250300

Rodless cylinders

6.DD series Ø 16 to 63

PLUS ||

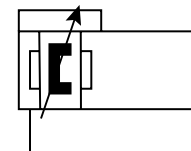

Rodless cylinders, double-acting, magnetic, pneumatic cushioning

Art. No.	Type No.	Piston Ø mm	Stroke mm	Connection	Force at 6 bar N	Max. lateral load Nm
106340	6.DD.400300	40	300	G 1/4	640	4
106341	6.DD.400400	40	400	G 1/4	640	4
106342	6.DD.400500	40	500	G 1/4	640	4
106343	6.DD.400600	40	600	G 1/4	640	4
106344	6.DD.400700	40	700	G 1/4	640	4
106345	6.DD.400800	40	800	G 1/4	640	4
106346	6.DD.400900	40	900	G 1/4	640	4
106347	6.DD.401000	40	1000	G 1/4	640	4
106348	6.DD.401200	40	1200	G 1/4	640	4
106349	6.DD.401400	40	1400	G 1/4	640	4
106350	6.DD.402000	40	2000	G 1/4	640	4
106351	6.DD.630100	63	100	G 3/8	1550	8
106352	6.DD.630200	63	200	G 3/8	1550	8
106353	6.DD.630300	63	300	G 3/8	1550	8
106354	6.DD.630400	63	400	G 3/8	1550	8
106355	6.DD.630500	63	500	G 3/8	1550	8
106356	6.DD.630600	63	600	G 3/8	1550	8
106357	6.DD.630700	63	700	G 3/8	1550	8
106358	6.DD.630800	63	800	G 3/8	1550	8
106359	6.DD.630900	63	900	G 3/8	1550	8
106360	6.DD.631000	63	1000	G 3/8	1550	8
106361	6.DD.631200	63	1200	G 3/8	1550	8
106362	6.DD.631400	63	1400	G 3/8	1550	8
106363	6.DD.632000	63	2000	G 3/8	1550	8

- All strokes can also be supplied in 1 mm steps on request.
Ø 16 to 5000 mm, Ø 25, 32, 40 to 5700 mm and Ø 63 to 5500 mm.
- Versions with an integrated linear guide can be supplied on request (up to 50x lateral load).
- Fixing parts and accessories please look at page 411-413



6.DD.400300



Fixing parts and accessories for rodless cylinders

6.DD series Ø 16 to 63



455.13-M



455.54-M



455.25-M



455.35-M



235.04-M-1

Foot model, 1 piece with 2 screws

Art. No.	Type No.	For cylinders	Suitable for piston Ø mm	Material	Type of construction
106364	455.11-M	6.DD	16	Steel	Aluminium bracket
106365	455.12-M	6.DD	25	Steel	Aluminium bracket
106366	455.13-M	6.DD	32	Aluminium	Aluminium profile
106367	455.14-M	6.DD	40	Aluminium	Aluminium profile
106368	455.15-M	6.DD	63	Aluminium	Aluminium flat profile

Intermediate foot

Art. No.	Type No.	For cylinders	Suitable for piston Ø mm	Material	Type of construction
106369	455.51-M	6.DD	16	Aluminium	Aluminium flat profile
106370	455.52-M	6.DD	25	Aluminium	Aluminium flat profile
106371	455.53-M	6.DD	32	Aluminium	Aluminium flat profile
106372	455.54-M	6.DD	40	Aluminium	Aluminium flat profile
106373	455.55-M	6.DD	63	Aluminium	Aluminium flat profile

Swing support, 1 kit for replacements on the standard cylinder

Art. No.	Type No.	For cylinders	Suitable for piston Ø mm	Material	Type of construction
106374	455.21-M	6.DD	16	Aluminium and steel	Rocker mounted on bolts
106375	455.22-M	6.DD	25	Aluminium and steel	Rocker mounted on bolts
106376	455.23-M	6.DD	32 - 40	Aluminium and steel	Rocker mounted on bolts
106377	455.25-M	6.DD	63	Aluminium and steel	Rocker mounted on bolts

Adjustable limit switch and shock absorber, 1 kit for mounting

Art. No.	Type No.	For cylinders	Suitable for piston Ø mm	Material
106378	455.31-M	6.DD	16	Anodised aluminium
106379	455.32-M	6.DD	25	Anodised aluminium
106380	455.33-M	6.DD	32	Anodised aluminium
106381	455.34-M	6.DD	40	Anodised aluminium
106382	455.35-M	6.DD	63	Anodised aluminium

Sensor for the T-slots and rectangular slots

Art. No.	Type No.	For cylinders	Applications	Description
194356	235.03-M-1	for all cylinders (not for short-stroke cylinders)	for the T-slots and rectangular slots	REED sensor, 2-wire, with 2.5 m cable length, LED
194357	235.04-M-1	for all cylinders (not for short-stroke cylinders)	for the T-slots and rectangular slots	REED sensor, 2-wire, with M8 plug, LED
194358	235.06-M-1	for all cylinders (not for short-stroke cylinders)	for the T-slots and rectangular slots	HALL sensor, 3-wire, with 2.5 m cable length, PNP, LED
194359	235.07-M-1	for all cylinders (not for short-stroke cylinders)	for the T-slots and rectangular slots	HALL sensor, 3-wire, with M8 plug, PNP, LED

Fixing parts and accessories for rodless cylinders

6.DD series Ø 16 to 63

Sensor support (with T-slot adapter)

Art. No.	Type No.	For cylinders	Suitable for piston Ø mm	Material	Description
106383	455.05-M	6.DD	16 - 25	Aluminium	Long version for mounting opposite the piston guide



455.05-M

Bar for grooving, 1 piece 500 mm

Art. No.	Type No.	For cylinders	Suitable for piston Ø mm	Material	Description
106384	455.06-M	Standard cylinder, rodless cylinder	32-125 / 32-63	PVC	For closing the T-slot and possibly the sensor cable guide



455.06-M



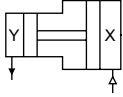

Double piston pressure multiplier (boosters)

The booster increases the existing supply pressure for one or more actuators in a fixed transmission ratio (see technical data) and thus provides the required working pressure. The booster is not suitable for applications that have a longer lasting air consumption – such as pneumatic grinders, air motors, vacuum generation via Venturi nozzles, etc. The design uses two coupled oscillating differential pistons and integrated check valves. To avoid fluctuations in output pressure, the use of a tank for pressure build-up and storage of compressed air is recommended. Operation with filtered and unlubricated or lubricated compressed air possible (once lubricated, continuous lubrication is necessary).

Input pressure	2 - 10 bar
Housing	Anodised aluminium
Jacket	Anodised aluminium jacket
Sealant	NBR
Mounting options	Any position, with 4 mounting holes



Pressure multiplier without pressure regulator

Art. No.	Type No.	Piston Ø mm	Max. output pressure bar	Temperature range °C	Thread	P2:P1
101529	B-921	40	20	-10 to 50	G 1/8	2:1
101530	B-923	63	20	-10 to 60	G 3/8	2:1



Pressure multiplier with pressure regulator

Art. No.	Type No.	Piston Ø mm	Max. output pressure bar	Temperature range °C	Thread	P2:P1	Pressure regulator
101531	B-922	40	16	-10 to 50	G 1/8	1:1 to 1,6:1	with plastic body
101532	B-924	63	16	-10 to 60	G 3/8	1:1 to 1,6:1	with plastic body

→ For information about calculating the filling times for different tank sizes, refer to our data sheet



Accessories / spare parts

Art. No.	Type No.	Description
101533	110.45-KD	Pressure gauge Ø 40 mm, G 1/8 ET, 0 - 6 bar/87 psi
101534	110.47-KD	Pressure gauge Ø 40 mm, G 1/8 ET, 0 - 16 bar/230 psi
101535	B-938	Set of gaskets (for pressure multiplier and regulator), Ø 40
101536	B-939	Set of gaskets (for pressure multiplier and regulator), Ø 63
101537	B-930	Regulator unit (regulator, adapter, fixing parts) for G 1/8
101538	B-931	Regulator unit (regulator, adapter, fixing parts) for G 3/8

Compressed air tanks

PLUS

Compact steel tanks in accordance with EU Directive 2014/68/EU.

Max. operating pressure	11 bar
Temperature range	-10 to 60 °C
Housing	Steel (FeP04), plastic covered

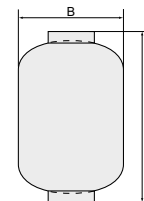

Compressed air tank, steel

Art. No.	Type No.	Volume Liter	Thread	A mm	B mm
101539	B 940	1	2 x G 1/2 IT	225.0	85.0
101540	B 941	2.5	2 x G 1/2 IT	170.0	160.0
101541	B 942	5	2 x G 1/2 IT	184.0	210.0
101542	B 943	7	2 x G 1/2 IT	240.0	210.0
101543	B 944	12	2 x G 1/2 IT	365.0	229.0



B 941

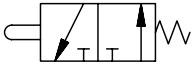



3/2-Wege Ventil NO

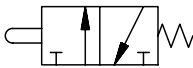

3/2-Wege Ventil NC

3/2-way miniature valves

mechanically operated

PLUS

Miniature valves, 3/2-way type, NC or NO.

Operating pressure	0.5 - 10 bar
Operating temperature	-10 to 60 °C
Flow rate at 6 bar and Δp 0.5 bar	35 Nl/min
Operating pressure at 6 bar	8 N
Valve body	Aluminium
Pushbutton	Nickel-plated brass
Sealant	NBR
Spring	Stainless steel



511.131



511.152



511.171



511.194

3/2-way miniature valve, with plunger

Art. No.	Type No.	Connection	Function	Nominal Ø mm
106385	511.121	Plug-in connector Ø 4 mm on side	3/2 NO	2.5
106386	511.122	M5 female thread on side	3/2 NO	2.5
106387	511.131	Plug-in connector Ø 4 mm on side	3/2 NC	2.5
106388	511.132	M5 female thread on side	3/2 NC	2.5

3/2-way miniature valve, with plunger, for panel mounting

Art. No.	Type No.	Connection	Function	Nominal Ø mm
106389	511.151	Plug-in connector Ø 4 mm on side	3/2 NC	2.5
106390	511.152	M5 female thread on side	3/2 NC	2.5

3/2-way miniature valve, with free-return roller lever

Art. No.	Type No.	Connection	Function	Nominal Ø mm
106391	511.171	Plug-in connector Ø 4 mm on side	3/2 NC	2.5
106392	511.172	M5 female thread on side	3/2 NC	2.5

3/2-way miniature valve, with roller lever

Art. No.	Type No.	Connection	Function	Nominal Ø mm
106393	511.191	Plug-in connector Ø 4 mm on side	3/2 NO	2.5
106394	511.192	M5 female thread on side	3/2 NO	2.5
106395	511.193	Plug-in connector Ø 4 mm on side	3/2 NC	2.5
106396	511.194	M5 female thread on side	3/2 NC	2.5

➔ For compatible screw fittings, refer to page 594

3/2-way miniature valves

manually operated, for panel mounting

PLUS

Monostable (non-latching) and bistable (latching) versions available.



Operating pressure	0.5 - 10 bar
Operating temperature	-10 to 60 °C
Flow rate at 6 bar and Δp 0.5 bar	35 Nl/min
Operating pressure at 6 bar	8 N
Valve body	Aluminium
Pushbutton	Nickel-plated brass
Sealant	NBR
Spring	Stainless steel

3/2-way miniature valve, manually operated, with pushbutton

Art. No.	Type No.	Connection	Function	Operation	Disc	Nominal Ø mm
106397	512.111	Plug-in connector Ø 4 mm on side	3/2 NC	Monostable	Black	2.5
106398	512.112	Plug-in connector Ø 4 mm on side	3/2 NC	Monostable	Red	2.5
106399	512.113	M5 female thread on side	3/2 NC	Monostable	Black	2.5
106400	512.114	M5 female thread on side	3/2 NC	Monostable	Red	2.5



512.111



512.213

3/2-way miniature valve, manually operated, with rotary knob (2 positions)

Art. No.	Type No.	Connection	Function	Operation	Nominal Ø mm
106401	512.203	Plug-in connector Ø 4 mm on side	3/2 NC	Monostable	2.5
106402	512.204	M5 female thread on side	3/2 NC	Monostable	2.5
106403	512.213	Plug-in connector Ø 4 mm on side	3/2 NC	Bistable	2.5
106404	512.214	M5 female thread on side	3/2 NC	Bistable	2.5



512.304

3/2-way miniature valve, manually operated, with wing lever (2 positions)

Art. No.	Type No.	Connection	Function	Operation	Nominal Ø mm
106405	512.303	Plug-in connector Ø 4 mm on side	3/2 NC	Monostable	2.5
106406	512.304	M5 female thread on side	3/2 NC	Monostable	2.5
106407	512.313	Plug-in connector Ø 4 mm on side	3/2 NC	Bistable	2.5
106408	512.314	M5 female thread on side	3/2 NC	Bistable	2.5



512.403

3/2-way miniature valve, manually operated, with hand lever (non-latching)

Art. No.	Type No.	Connection	Function	Operation	Nominal Ø mm
106409	512.403	Plug-in connector Ø 4 mm on side	3/2 NC	Monostable	2.5
106410	512.404	M5 female thread on side	3/2 NC	Monostable	2.5



512.513

3/2-way miniature valve, manually operated, with pull switch, bistable, with lock

Art. No.	Type No.	Connection	Function	Operation	Nominal Ø mm
106411	512.513	Plug-in connector Ø 4 mm on side	3/2 NC	Bistable	2.5
106412	512.514	M5 female thread on side	3/2 NC	Bistable	2.5



512.604

3/2-way miniature valve, manually operated, with mushroom pushbutton

Art. No.	Type No.	Connection	Function	Operation	Nominal Ø mm
106413	512.603	Plug-in connector Ø 4 mm on side	3/2 NC	Monostable	2.5
106414	512.604	M5 female thread on side	3/2 NC	Monostable	2.5



512.704

3/2-way miniature valve, manually operated, with mushroom pushbutton and emergency latch

Art. No.	Type No.	Connection	Function	Nominal Ø mm
106415	512.703	Plug-in connector Ø 4 mm on side	3/2 NC	2.5
106416	512.704	M5 female thread on side	3/2 NC	2.5

→ For compatible screw fittings, refer to page 594

→ For actuating elements as spare parts / accessories, see page 420

3/2-way pilot valves

manually operated, for panel mounting

PLUS



515.201

Temperature range	-10 to 60 °C
Valve body	Aluminium
Piston	Aluminium
Sealant	NBR
Spring	Special steel
Flow rate at 6 bar and Δp 0.5 bar	400 NI/min
Flow rate at 6 bar and Δp 1.0 bar	550 NI/min



515.301

3/2-way pilot valve, manually operated, with pushbutton, NC

Art. No.	Type No.	Connection	Operating pressure bar	Symbol	Operation	Disc
106417	515.201	G 1/8	2.5 - 10	4	Monostable	Red/black

3/2-way pilot valve, manually operated, with monostable hand lever, NC

Art. No.	Type No.	Connection	Operating pressure bar	Symbol	Operation
106418	515.301	G 1/8	2.5 - 10	3	Monostable



515.401

3/2-way pilot valve, manually operated, with short wing lever, NC

Art. No.	Type No.	Connection	Operating pressure bar	Symbol	Operation	Valve positions
106419	515.401	G 1/8	2.5 - 10	5	Monostable	2
106420	515.402	G 1/8	1 - 10	6	Bistable	2
106421	515.403	G 1/8	2.5 - 10	7	Monostable	3
106422	515.404	G 1/8	1 - 10	8	Bistable	3



515.501

3/2-way pilot valve, manually operated, with long wing lever, NC

Art. No.	Type No.	Connection	Operating pressure bar	Symbol	Operation	Valve positions
106423	515.501	G 1/8	2.5 - 10	9	Monostable	2
106424	515.502	G 1/8	1 - 10	10	Bistable	2
106425	515.503	G 1/8	2.5 - 10	11	Monostable	3
106426	515.504	G 1/8	1 - 10	12	Bistable	3



515.601

3/2-way pilot valve, manually operated, with mushroom pushbutton, NC

Art. No.	Type No.	Connection	Operating pressure bar	Symbol	Operation
106427	515.601	G 1/8	2.5 - 10	13	Monostable



515.701

3/2-way pilot valve, manually operated, with mushroom pushbutton and emergency latch, NC

Art. No.	Type No.	Connection	Operating pressure bar	Symbol	Operation
106428	515.701	G 1/8	2.5 - 10	14	Monostable

- Accessories and spare parts see page 420
- 3 valve positions only in conjunction with a second 3/2-way valve 515.101 type. Corresponds to a 5/3-way valve.

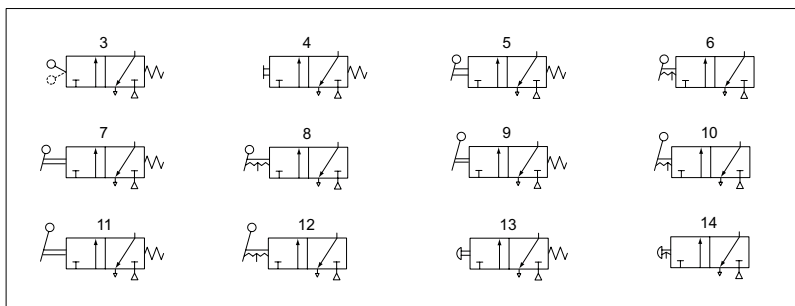

5/2-way pilot valves

manually operated, for panel mounting

PLUS

Temperature range	-10 to 60 °C
Valve body	Aluminium
Piston	Aluminium
Sealant	NBR
Spring	Special steel
Flow rate at 6 bar and Δp 0.5 bar	400 NI/min
Flow rate at 6 bar and Δp 1.0 bar	550 NI/min



515.211

5/2-way pilot valve, manually operated, with pushbutton

Art. No.	Type No.	Connection	Operating pressure bar	Symbol	Operation	Disc
106429	515.211	G 1/8	2.5 - 10	4	Monostable	Red/black



515.311

5/2-way pilot valve, manually operated, with monostable hand lever

Art. No.	Type No.	Connection	Operating pressure bar	Symbol	Operation
106430	515.311	G 1/8	2.5 - 10	3	Monostable

5/2-way pilot valve, manually operated, with short wing lever

Art. No.	Type No.	Connection	Operating pressure bar	Symbol	Operation	Valve positions
106431	515.411	G 1/8	2.5 - 10	5	Monostable	2
106432	515.412	G 1/8	1 - 10	6	Bistable	2
106433	515.413	G 1/8	2.5 - 10	7	Monostable	3
106434	515.414	G 1/8	1 - 10	8	Bistable	3



515.411

5/2-way pilot valve, manually operated, with long wing lever

Art. No.	Type No.	Connection	Operating pressure bar	Symbol	Operation	Valve positions
106435	515.511	G 1/8	2.5 - 10	9	Monostable	2
106436	515.512	G 1/8	1 - 10	10	Bistable	2
106437	515.513	G 1/8	2.5 - 10	11	Monostable	3
106438	515.514	G 1/8	1 - 10	12	Bistable	3



515.511

5/2-way pilot valve, manually operated, with mushroom pushbutton

Art. No.	Type No.	Connection	Operating pressure bar	Symbol	Operation
106439	515.611	G 1/8	2.5 - 10	13	Monostable

5/2-way pilot valve, manually operated, with mushroom pushbutton and emergency latch

Art. No.	Type No.	Connection	Operating pressure bar	Symbol	Operation
106440	515.711	G 1/8	2.5 - 10	14	Monostable



515.611

- Accessories and spare parts see page 420
- 3 valve positions only in conjunction with a second way valve.

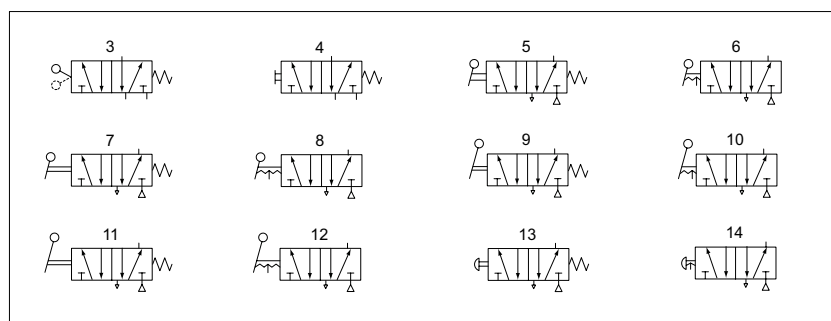

515.711

Accessories and spare parts for 3/2-way miniature valves, manually operated and for 3/2-, 5/2-way pilot valves, manually operated

Accessories and spare parts



515.101

515.111



A2V

DK-M



HH-M

KDH-3M



LDH-2M

V2SS-JS



RPT-M

RPT-NR

Art. No.	Type No.	Description
106441	515.101	Plunger valve, 3/2-way, monostable, NC, G 1/8
106442	515.111	Plunger valve, 5/2-way, monostable, NC, G 1/8
106443	A2V	Adapter max. 2 valves, required for mounting on basic valve
106444	DK-M	Pushbutton with red or black disc, monostable
106445	HH-M	Hand lever, red, monostable
106446	KDH-2M	Short wing lever, black, 2 positions, monostable
106447	KDH-2B	Short wing lever, black, 2 positions, bistable
106448	KDH-3M	Short wing lever, black, 3 positions, monostable
106449	KDH-3B	Short wing lever, black, 3 positions, bistable
106450	LDH-2M	Long wing lever, black, 2 positions, monostable
106451	LDH-2B	Long wing lever, black, 2 positions, bistable
106452	LDH-3M	Long wing lever, black, 3 positions, monostable
106453	LDH-3B	Long wing lever, black, 3 positions, bistable
106454	V2SS-JS	Lockable switch, 2 pos., key can be withdrawn in any pos.
106455	V2SS-GS	Lockable switch, 2 pos., key can be withdrawn in normal pos.
106456	RPT-M	Mushroom pushbutton, red, monostable
106457	RPT-NR	Mushroom pushbutton and emergency latch, red

→ The adapter 106443 is required to mount the actuating attachments 106444 to 106457.

3/2, 5/2 and 5/3-way pilot valves

manually operated

PLUS

These pilot valves are also suitable for max. vacuum 10 bar.

Operating pressure	Max. vacuum 10 bar
Temperature range	-10 to 60 °C
Valve body	Aluminium
Piston	Nickel-plated aluminium
Sealant	NBR
Spring	Special steel
Flow rate measurement 1	Flow rate at 6 bar and Δp 0.5 bar
Flow rate measurement 2	Flow rate at 6 bar and Δp 1.0 bar

3/2, 5/2 and 5/3-way pilot valves, 90° lever

Art. No.	Type No.	Connec-tion	Flow rate 1 NI/min	Flow rate 2 NI/min	Function	Operation	Symbol
106458	514.101	G 1/8	400	550	3/2	Monostable	10
106459	514.102	G 1/8	400	550	3/2	Bistable	11
106460	514.103	G 1/4	750	1100	3/2	Monostable	10
106461	514.104	G 1/4	750	1100	3/2	Bistable	11
106462	514.105	G 1/2	3200	4600	3/2	Monostable	10
106463	514.106	G 1/2	3200	4600	3/2	Bistable	11
106464	514.111	G 1/8	400	550	5/2	Monostable	12
106465	514.112	G 1/8	400	550	5/2	Bistable	13
106466	514.113	G 1/4	750	1100	5/2	Monostable	12
106467	514.114	G 1/4	750	1100	5/2	Bistable	13
106468	514.115	G 1/2	3200	4600	5/2	Monostable	12
106469	514.116	G 1/2	3200	4600	5/2	Bistable	13
106470	514.121	G 1/8	400	550	5/3	Mid-position closed, spring return	14
106471	514.122	G 1/8	400	550	5/3	Mid-position exhausted, spring return	15
106472	514.123	G 1/8	400	550	5/3	Mid-position pressurised, spring return	16
106473	514.124	G 1/8	400	550	5/3	Mid-position closed, detent	17
106474	514.125	G 1/8	400	550	5/3	Mid-position exhausted, detent	18
106475	514.126	G 1/8	400	550	5/3	Mid-position pressurised, detent	19
106476	514.131	G 1/4	750	1100	5/3	Mid-position closed, spring return	14
106477	514.132	G 1/4	750	1100	5/3	Mid-position exhausted, spring return	15
106478	514.133	G 1/4	750	1100	5/3	Mid-position pressurised, spring return	16
106479	514.134	G 1/4	750	1100	5/3	Mid-position closed, detent	17
106480	514.135	G 1/4	750	1100	5/3	Mid-position exhausted, detent	18
106481	514.136	G 1/4	750	1100	5/3	Mid-position pressurised, detent	19
106482	514.141	G 1/2	3200	4600	5/3	Mid-position closed, spring return	14
106483	514.142	G 1/2	3200	4600	5/3	Mid-position exhausted, spring return	15
106484	514.143	G 1/2	3200	4600	5/3	Mid-position pressurised, spring return	16
106485	514.144	G 1/2	3200	4600	5/3	Mid-position closed, detent	17
106486	514.145	G 1/2	3200	4600	5/3	Mid-position exhausted, detent	18
106487	514.146	G 1/2	3200	4600	5/3	Mid-position pressurised, detent	19



514.103



514.113



514.123

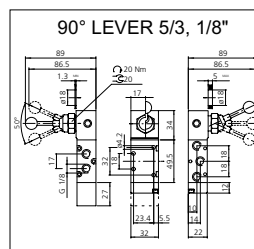
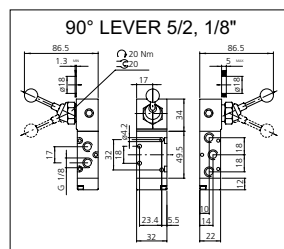
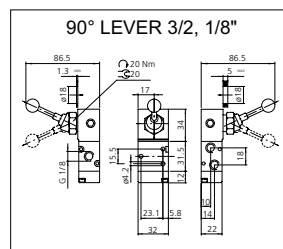
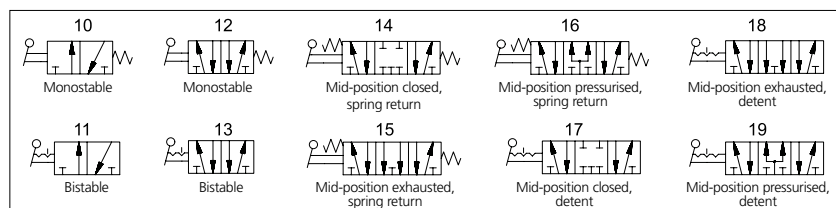

3/2, 5/2 and 5/3-way pilot valves

pneumatic

PLUS

Temperature range	-10 to 60 °C
Flow rate measurement 1	Flow rate at 6 bar and Δp 0.5 bar
Flow rate measurement 2	Flow rate at 6 bar and Δp 1.0 bar



516.102

3/2-way pilot valve

Art. No.	Type No.	Connec-tion	Operating pressure bar	Function	Operation	Flow rate 1 NI/min	Flow rate 2 NI/min	Symbol
106488	516.101	G 1/8	2.5 - 10	3/2 NO	Monostable	400	550	24
106489	516.102	G 1/4	2.5 - 10	3/2 NO	Monostable	750	1100	24
106490	516.102-38	G 3/8	2.5 - 10	3/2 NO	Monostable	1560	2150	24
106491	516.105	G 1/2	2.5 - 10	3/2 NO	Monostable	3200	4600	24
106492	516.103	G 1/8	2.5 - 10	3/2 NC	Monostable	400	550	25
106493	516.104	G 1/4	2.5 - 10	3/2 NC	Monostable	750	1100	25
106494	516.104-38	G 3/8	2.5 - 10	3/2 NC	Monostable	1560	2150	25
106495	516.106	G 1/2	2.5 - 10	3/2 NC	Monostable	3200	4600	25
106496	516.201	G 1/8	1 - 10	3/2	Bistable	400	550	26
106497	516.202	G 1/4	1 - 10	3/2	Bistable	750	1100	26
106498	516.202-38	G 3/8	1 - 10	3/2	Bistable	1560	2150	26
106499	516.203	G 1/2	1 - 10	3/2	Bistable	3200	4600	26



516.302

5/2-way pilot valve

Art. No.	Type No.	Connec-tion	Operating pressure bar	Function	Operation	Flow rate 1 NI/min	Flow rate 2 NI/min	Symbol
106500	516.301	G 1/8	2.5 - 10	5/2	Monostable	400	550	27
106501	516.302	G 1/4	2.5 - 10	5/2	Monostable	750	1100	27
106502	516.302-38	G 3/8	2.5 - 10	5/2	Monostable	1560	2150	27
106503	516.305	G 1/2	2.5 - 10	5/2	Monostable	3200	4600	27
106504	516.303	G 1/8	1 - 10	5/2	Bistable	400	550	28
106505	516.304	G 1/4	1 - 10	5/2	Bistable	750	1100	28
106506	516.304-38	G 3/8	1 - 10	5/2	Bistable	1560	2150	28
106507	516.306	G 1/2	1 - 10	5/2	Bistable	3200	4600	28



516.501

5/3-way pilot valve (monostable)

Art. No.	Type No.	Connec-tion	Operating pressure bar	Function	Operation	Flow rate 1 NI/min	Flow rate 2 NI/min	Symbol
106508	516.401	G 1/8	2.5 - 10	5/3	Mid-position closed	400	550	29
106509	516.402	G 1/8	2.5 - 10	5/3	Mid-position exhausted	400	550	30
106510	516.403	G 1/8	2.5 - 10	5/3	Mid-position pressurised	400	550	31
106511	516.501	G 1/4	2.5 - 10	5/3	Mid-position closed	750	1100	29
106512	516.502	G 1/4	2.5 - 10	5/3	Mid-position exhausted	750	1100	30
106513	516.503	G 1/4	2.5 - 10	5/3	Mid-position pressurised	750	1100	31
106514	516.501-38	G 3/8	2.5 - 10	5/3	Mid-position closed	1560	2150	29
106515	516.502-38	G 3/8	2.5 - 10	5/3	Mid-position exhausted	1560	2150	30
106516	516.503-38	G 3/8	2.5 - 10	5/3	Mid-position pressurised	1560	2150	31
106517	516.601	G 1/2	2.5 - 10	5/3	Mid-position closed	3200	4600	29
106518	516.602	G 1/2	2.5 - 10	5/3	Mid-position exhausted	3200	4600	30
106519	516.603	G 1/2	2.5 - 10	5/3	Mid-position pressurised	3200	4600	31

➔ Feed blocks and multiple manifold bases please look at page 426

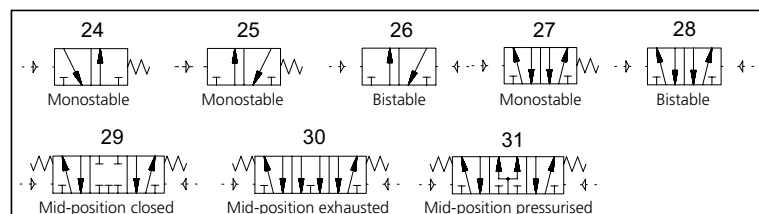

3/2, 5/2 and 5/3-way pilot valves

electro-pneumatic

PLUS

Medium temperature	-10 to 60 °C
Ambient temperature	-10 to 50 °C
Flow rate measurement 1	Flow rate at 6 bar and Δp 0.5 bar
Flow rate measurement 2	Flow rate at 6 bar and Δp 1.0 bar
Manual control	latching

3/2-way pilot valves

Art. No.	Type No.	Connection	Voltage	Function	Operation	Operating pressure bar	Symbol	Flow rate 1 NI/min	Flow rate 2 NI/min
106520	517.101	G 1/8	24 V DC	3/2 NO	Monostable	2.5 - 10	32	400	550
106521	517.102	G 1/4	24 V DC	3/2 NO	Monostable	2.5 - 10	32	750	1100
106522	517.102-38	G 3/8	24 V DC	3/2 NO	Monostable	2.5 - 10	32	1560	2150
106523	517.103	G 1/2	24 V DC	3/2 NO	Monostable	2.5 - 10	32	3200	4600
106524	517.104	G 1/8	230 V, 50 Hz	3/2 NO	Monostable	2.5 - 10	32	400	550
106525	517.105	G 1/4	230 V, 50 Hz	3/2 NO	Monostable	2.5 - 10	32	750	1100
106526	517.105-38	G 3/8	230 V, 50 Hz	3/2 NO	Monostable	2.5 - 10	32	1560	2150
106527	517.106	G 1/2	230 V, 50 Hz	3/2 NO	Monostable	2.5 - 10	32	3200	4600
106528	517.111	G 1/8	24 V DC	3/2 NC	Monostable	2.5 - 10	33	400	550
106529	517.112	G 1/4	24 V DC	3/2 NC	Monostable	2.5 - 10	33	750	1100
106530	517.112-38	G 3/8	24 V DC	3/2 NC	Monostable	2.5 - 10	33	1560	2150
106531	517.113	G 1/2	24 V DC	3/2 NC	Monostable	2.5 - 10	33	3200	4600
106532	517.114	G 1/8	230 V, 50 Hz	3/2 NC	Monostable	2.5 - 10	33	400	550
106533	517.115	G 1/4	230 V, 50 Hz	3/2 NC	Monostable	2.5 - 10	33	750	1100
106534	517.115-38	G 3/8	230 V, 50 Hz	3/2 NC	Monostable	2.5 - 10	33	1560	2150
106535	517.116	G 1/2	230 V, 50 Hz	3/2 NC	Monostable	2.5 - 10	33	3200	4600
106536	517.121	G 1/8	24 V DC	3/2	Bistable	1 - 10	34	400	550
106537	517.122	G 1/4	24 V DC	3/2	Bistable	1 - 10	34	750	1100
106538	517.122-38	G 3/8	24 V DC	3/2	Bistable	1 - 10	34	1560	2150
106539	517.123	G 1/2	24 V DC	3/2	Bistable	1 - 10	34	3200	4600
106540	517.124	G 1/8	230 V, 50 Hz	3/2	Bistable	1 - 10	34	400	550
106541	517.125	G 1/4	230 V, 50 Hz	3/2	Bistable	1 - 10	34	750	1100
106542	517.125-38	G 3/8	230 V, 50 Hz	3/2	Bistable	1 - 10	34	1560	2150
106543	517.126	G 1/2	230 V, 50 Hz	3/2	Bistable	1 - 10	34	3200	4600



517.112



517.125

3/2, 5/2 and 5/3-way pilot valves

electro-pneumatic



517.202



517.212



517.222

5/2-way pilot valves

Art. No.	Type No.	Connection	Voltage	Function	Operation	Operating pressure bar	Symbol	Flow rate 1 NI/min	Flow rate 2 NI/min
106544	517.201	G 1/8	24 V DC	5/2	Monostable	2.5 - 10	35	400	550
106545	517.202	G 1/4	24 V DC	5/2	Monostable	2.5 - 10	35	750	1100
106546	517.202-38	G 3/8	24 V DC	5/2	Monostable	2.5 - 10	35	1560	2150
106547	517.203	G 1/2	24 V DC	5/2	Monostable	2.5 - 10	35	3200	4600
106548	517.204	G 1/8	230 V, 50 Hz	5/2	Monostable	2.5 - 10	35	400	550
106549	517.205	G 1/4	230 V, 50 Hz	5/2	Monostable	2.5 - 10	35	750	1100
106550	517.205-38	G 3/8	230 V, 50 Hz	5/2	Monostable	2.5 - 10	35	1560	2150
106551	517.206	G 1/2	230 V, 50 Hz	5/2	Monostable	2.5 - 10	35	3200	4600
106552	517.211	G 1/8	24 V DC	5/2	Bistable	1 - 10	36	400	550
106553	517.212	G 1/4	24 V DC	5/2	Bistable	1 - 10	36	750	1100
106554	517.212-38	G 3/8	24 V DC	5/2	Bistable	1 - 10	36	1560	2150
106555	517.213	G 1/2	24 V DC	5/2	Bistable	1 - 10	36	3200	4600
106556	517.214	G 1/8	230 V, 50 Hz	5/2	Bistable	1 - 10	36	400	550
106557	517.215	G 1/4	230 V, 50 Hz	5/2	Bistable	1 - 10	36	750	1100
106558	517.215-38	G 3/8	230 V, 50 Hz	5/2	Bistable	1 - 10	36	1560	2150
106559	517.216	G 1/2	230 V, 50 Hz	5/2	Bistable	1 - 10	36	3200	4600

5/2-way pilot valves, with differential piston

Art. No.	Type No.	Connection	Voltage	Function	Operation	Operating pressure bar	Symbol	Flow rate 1 NI/min	Flow rate 2 NI/min
106560	517.221	G 1/8	24 V DC	5/2	Bistable	1 - 10	36	400	550
106561	517.222	G 1/4	24 V DC	5/2	Bistable	1 - 10	36	750	1100
106562	517.222-38	G 3/8	24 V DC	5/2	Bistable	1 - 10	36	1560	2150
106563	517.223	G 1/2	24 V DC	5/2	Bistable	1 - 10	36	3200	4600
106564	517.224	G 1/8	230 V, 50 Hz	5/2	Bistable	1 - 10	36	400	550
106565	517.225	G 1/4	230 V, 50 Hz	5/2	Bistable	1 - 10	36	750	1100
106566	517.225-38	G 3/8	230 V, 50 Hz	5/2	Bistable	1 - 10	36	1560	2150
106567	517.226	G 1/2	230 V, 50 Hz	5/2	Bistable	1 - 10	36	3200	4600

3/2, 5/2 and 5/3-way pilot valves

electro-pneumatic



517.302

5/3-way pilot valves (monostable)									
Art. No.	Type No.	Connection	Voltage	Function	Operation	Symbol	Flow rate 1 NI/min	Flow rate 2 NI/min	
106568	517.301	G 1/8	24 V DC	5/3	Mid-position closed	37	400	550	
106569	517.302	G 1/4	24 V DC	5/3	Mid-position closed	37	750	1100	
106570	517.302-38	G 3/8	24 V DC	5/3	Mid-position closed	37	1560	2150	
106571	517.303	G 1/2	24 V DC	5/3	Mid-position closed	37	3200	4600	
106572	517.304	G 1/8	230 V, 50 Hz	5/3	Mid-position closed	37	400	550	
106573	517.305	G 1/4	230 V, 50 Hz	5/3	Mid-position closed	37	750	1100	
106574	517.305-38	G 3/8	230 V, 50 Hz	5/3	Mid-position closed	37	1560	2150	
106575	517.306	G 1/2	230 V, 50 Hz	5/3	Mid-position closed	37	3200	4600	
106576	517.311	G 1/8	24 V DC	5/3	Mid-position exhausted	38	400	550	
106577	517.312	G 1/4	24 V DC	5/3	Mid-position exhausted	38	750	1100	
106578	517.312-38	G 3/8	24 V DC	5/3	Mid-position exhausted	38	1560	2150	
106579	517.313	G 1/2	24 V DC	5/3	Mid-position exhausted	38	3200	4600	
106580	517.314	G 1/8	230 V, 50 Hz	5/3	Mid-position exhausted	38	400	550	
106581	517.315	G 1/4	230 V, 50 Hz	5/3	Mid-position exhausted	38	750	1100	
106582	517.315-38	G 3/8	230 V, 50 Hz	5/3	Mid-position exhausted	38	1560	2150	
106583	517.316	G 1/2	230 V, 50 Hz	5/3	Mid-position exhausted	38	3200	4600	
106584	517.321	G 1/8	24 V DC	5/3	Mid-position pressurised	39	400	550	
106585	517.322	G 1/4	24 V DC	5/3	Mid-position pressurised	39	750	1100	
106586	517.322-38	G 3/8	24 V DC	5/3	Mid-position pressurised	39	1560	2150	
106587	517.323	G 1/2	24 V DC	5/3	Mid-position pressurised	39	3200	4600	
106588	517.324	G 1/8	230 V, 50 Hz	5/3	Mid-position pressurised	39	400	550	
106589	517.325	G 1/4	230 V, 50 Hz	5/3	Mid-position pressurised	39	750	1100	
106590	517.325-38	G 3/8	230 V, 50 Hz	5/3	Mid-position pressurised	39	1560	2150	
106591	517.326	G 1/2	230 V, 50 Hz	5/3	Mid-position pressurised	39	3200	4600	

➔ Feed blocks and multiple manifold bases please look at page 426

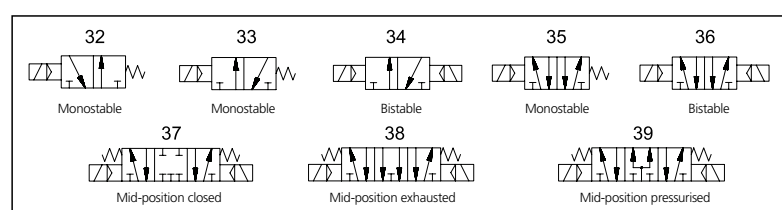

Feed blocks

for the pilot valves, pneumatic and electro-pneumatic

Quick and easy assembly system for side-by-side mounting of the above control valve types.

Requires one set of mounting brackets and a feed block.

Not for 5/2-way spool valves - Robust type and 3A, 4A, 3V, 4V type.



518.60-14



519.05-14

Feed block

Art. No.	Type No.	Description	For valve port
106604	518.120-18	Mounting bracket set, height 120.0 mm	G 1/8
106605	518.60-18	Mounting bracket set, height 60.0 mm	G 1/8
106606	518.30-18	Mounting bracket set, height 30.0 mm	G 1/8
106607	518.120-14	Mounting bracket set, height 120.0 mm	G 1/4
106608	518.60-14	Mounting bracket set, height 60.0 mm	G 1/4
106609	518.30-14	Mounting bracket set, height 30.0 mm	G 1/4
106610	518.02-18	Feed block with 2 valve positions	G 1/8
106611	518.03-18	Feed block with 3 valve positions	G 1/8
106612	518.04-18	Feed block with 4 valve positions	G 1/8
106613	518.05-18	Feed block with 5 valve positions	G 1/8
106614	518.06-18	Feed block with 6 valve positions	G 1/8
106615	518.07-18	Feed block with 7 valve positions	G 1/8
106616	519.02-14	Feed block with 2 valve positions	G 1/4
106617	519.03-14	Feed block with 3 valve positions	G 1/4
106618	519.04-14	Feed block with 4 valve positions	G 1/4
106619	519.05-14	Feed block with 5 valve positions	G 1/4
106620	519.06-14	Feed block with 6 valve positions	G 1/4
106621	519.07-14	Feed block with 7 valve positions	G 1/4

Multiple manifold bases

for the pilot valves, pneumatic and electro-pneumatic

Light alloy manifold bases for 2 to 10 valve positions.

Not for 5/2-way spool valves - Robust type and 3A, 4A, 3V, 4V type.

Material aluminium



520.08-18



520.18-A

Multiple manifold base

Art. No.	Type No.	Description	For valve port
106622	520.02-18	Manifold base for 2 valve positions	G 1/8
106623	520.03-18	Manifold base for 3 valve positions	G 1/8
106624	520.04-18	Manifold base for 4 valve positions	G 1/8
106625	520.05-18	Manifold base for 5 valve positions	G 1/8
106626	520.06-18	Manifold base for 6 valve positions	G 1/8
106627	520.07-18	Manifold base for 7 valve positions	G 1/8
106628	520.08-18	Manifold base for 8 valve positions	G 1/8
106629	520.09-18	Manifold base for 9 valve positions	G 1/8
106630	520.10-18	Manifold base for 10 valve positions	G 1/8
106631	520.18-A	Blanking plate G 1/4 manifold base for G 1/8 conn. surface	G 1/8
119139 NEW	520.18-V	Plugs for multiple manifold base, G 1/8	G 1/8
129152 NEW	520.18-Z	Intermediate plugs for multiple manifold base, G 1/8	G 1/8

Multiple manifold bases

for the pilot valves, pneumatic and electro-pneumatic

Multiple manifold base			
Art. No.	Type No.	Description	For valve port
106632	520.02-14	Manifold base for 2 valve positions	G 1/4
106633	520.03-14	Manifold base for 3 valve positions	G 1/4
106634	520.04-14	Manifold base for 4 valve positions	G 1/4
106635	520.05-14	Manifold base for 5 valve positions	G 1/4
106636	520.06-14	Manifold base for 6 valve positions	G 1/4
106637	520.07-14	Manifold base for 7 valve positions	G 1/4
106638	520.08-14	Manifold base for 8 valve positions	G 1/4
106639	520.09-14	Manifold base for 9 valve positions	G 1/4
106640	520.10-14	Manifold base for 10 valve positions	G 1/4
106641	520.14-A	Blanking plate G 3/8 manifold base for G 1/4 conn. surface	G 1/4
119136 NEW	520.14-V	Plugs for multiple manifold base, G 1/4	G 1/4
129153 NEW	520.14-Z	Intermediate plugs for multiple manifold base, G 1/4	G 1/4



520.03-14



520.14-V

5/2-way spool valves

robust type

MAX

This valve design, featuring the Tapered Tee Seal[®], offers the ability to run without lubrication and supports almost any compressed air quality.

The valves are largely resistant to dirt and can thus also be used under extreme conditions without any problems. Leakage is now a thing of the past and the spool no longer sticks, even after long idle periods.



Operating pressure	2.5 - 10 bar
Temperature range	-10 to 60 °C
Min. pilot pressure	2.5 bar
Electrical connection	Coupler plug PG 9, form B
Protection IP	IP 65 (DIN 46244)
Housing	Anodised aluminium, blue
Spool	Stainless steel
Sealant	NBR
Flow rate measurement 1	Flow rate at 6 bar and Δp 1.0 bar
Manual control	non-latching

5/2-way spool valve, single solenoid

Art. No.	Type No.	Connection	Voltage	DN	Function	Operation	Flow rate 1 NI/min	Symbol
106592	517.422	G 1/4	24 V DC	7.5	5/2	Monostable	1500	35
106593	517.423	G 1/2	24 V DC	15	5/2	Monostable	4600	35
106594	517.425	G 1/4	230 V AC, 50 Hz	7.5	5/2	Monostable	1500	35
106595	517.426	G 1/2	230 V AC, 50 Hz	15	5/2	Monostable	4600	35



517.422

5/2-way spool valve, double solenoid

Art. No.	Type No.	Connection	Voltage	DN	Function	Operation	Flow rate 1 NI/min	Symbol
106596	517.522	G 1/4	24 V DC	7.5	5/2	Bistable	1500	36
106597	517.523	G 1/2	24 V DC	15	5/2	Bistable	4600	36
106598	517.525	G 1/4	230 V AC, 50 Hz	7.5	5/2	Bistable	1500	36
106599	517.526	G 1/2	230 V AC, 50 Hz	15	5/2	Bistable	4600	36



517.522

5/2-way spool valves

robust type

MAX



517.622



517.632

5/2-way spool valve, single pneumatic

Art. No.	Type No.	Connection	DN	Function	Operation	Flow rate 1 NI/min	Symbol
106600	517.622	G 1/4	7.5	5/2	Monostable	1500	27
106601	517.623	G 1/2	15	5/2	Monostable	4600	27

5/2-way spool valve, double pneumatic

Art. No.	Type No.	Connection	DN	Function	Operation	Flow rate 1 NI/min	Symbol
106602	517.632	G 1/4	7.5	5/2	Bistable	1500	28
106603	517.633	G 1/2	15	5/2	Bistable	4600	28

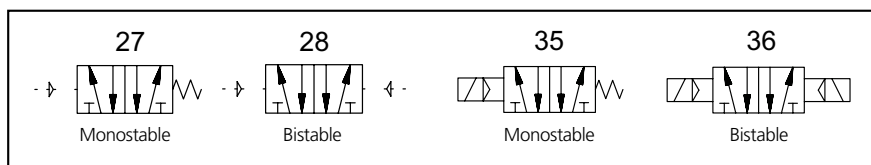

3/2 and 5/2-way valve

with NAMUR style interface

EASY

Pilot-operated 3/2 and 5/2-way spool valves with threaded ports and a NAMUR style interface.

Combines high-quality design with a low price.

By adding the conversion plate supplied with each valve, the device can be adapted to a 3/2-way function.

The valve is turned on by a continuous signal. Turning off causes the piston to be returned to its initial position under pressure.

Includes a manual operator as standard.

Medium	Air, neutral gases (filtered)
Working pressure	1.5 - 8 bar
Operating temperature	-5 to 50 °C
Housing	Aluminium
Sealant	NBR
Electrical connection	Connector socket PG 9 with LED display
Manual control	latching/non-latching

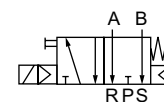

552.02



552.04

3/2 and 5/2-way valve

Art. No.	Type No.	Voltage	Port 1	Port 3	Port 5	DN	Flow rate l/min
130277	552.01	230 V, 50 Hz	G 1/4	G 1/4	G 1/4	8	1370
130278	552.02	24 V DC	G 1/4	G 1/4	G 1/4	8	1370
103651	552.03	230 V, 50 Hz	G 3/8	G 1/4	G 1/4	10	1650
103652	552.04	24 V DC	G 3/8	G 1/4	G 1/4	10	1650

3/2-5/2-way spool valve

with NAMUR style interface

PLUS

3/2 and 5/2-way spool valves, monostable, with air purging function and pneumatic spring return.

With latching manual operator and optional outgoing air restriction.

Medium	Air, neutral gases (filtered)
Operating temperature	-20 to 70 °C
Working pressure	1.5 - 10 bar
Power input	3 W=/ 5 VA~
Housing	Aluminium anodised
Spool	Stainless steel
Sealant	NBR
Connection	G 1/4
DN	7
Electrical connection	Connector socket Pg 9
Scope of delivery	Plug connector PG 9, 1 coding pin, 2 Orings, 2 fixing screws
Manual control	latching

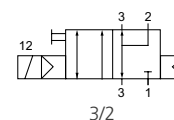

551.12

3/2-way spool valve with NAMUR style interface, NC

Art. No.	Type No.	Voltage	Flow rate l/min
103657	551.11	230 V, 50 Hz	1250
103658	551.12	24 V DC	1250

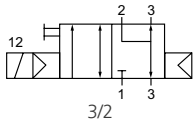

3/2-5/2-way spool valve

with NAMUR style interface

PLUS

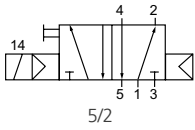

3/2-way spool valve with NAMUR style interface, NC, ports 1 and 3 or 2 and 3 swapped

Art. No.	Type No.	Voltage	Flow rate l/min
103659	551.21	230 V, 50 Hz	1250
103660	551.22	24 V DC	1250



551.32

5/2-way spool valve with NAMUR style interface

Art. No.	Type No.	Voltage	Flow rate l/min
103661	551.31	230 V, 50 Hz	1250
103662	551.32	24 V DC	1250

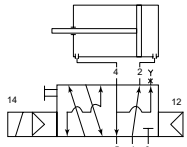

552.11 / 552.12 (5/2)

3/2 and 5/2-way spool valve

with NAMUR style interface

PLUS

Pilot-operated 3/2- and 5/2-way spool valves with threaded ports and a NAMUR style interface with air purging function.

By adding the conversion plate supplied with each valve, the device can be adapted to 3/2-way function.

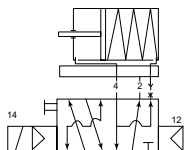

552.11 / 552.12 (3/2)

Medium	Air, neutral gases (filtered)
Operating temperature	-20 to 50 °C
Power input	3 W= / 5 VA~
Housing	Aluminium anodised
Spool	Stainless steel
Sealant	NBR
Connection	G 1/4 (Port 1), G 1/4 (Port 3 and 5)
DN	7
Electrical connection	Connector socket Pg 9
Scope of delivery	Plug connector PG 9, conversion plate, screws and seal
Manual control	latching

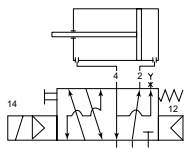

552.21 / 552.22 (5/2)

3/2- and 5/2-way spool valve with NAMUR style interface and air spring

Art. No.	Type No.	Voltage	Min. working pressure bar	Max. working pressure bar	Flow rate l/min
103653	552.11	230 V, 50 Hz	1.5	10	1250
103654	552.12	24 V DC	1.5	10	1250

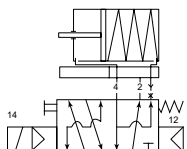

552.21 / 552.22 (3/2)

3/2- and 5/2-way spool valve with NAMUR style interface and combined spring return

Art. No.	Type No.	Voltage	Min. working pressure bar	Max. working pressure bar	Flow rate l/min
103655	552.21	230 V, 50 Hz	2.5	10	1250
103656	552.22	24 V DC	2.5	10	1250



552.11

3/2 and 5/2-way valves

with NAMUR style interface

MAX

Pilot-operated 3/2 and 5/2-way spool valves with threaded port connections and a NAMUR style interface. The two conversion plates supplied with each valve allow the device to be adapted to a 3/2-way or 5/2-way function. The valve is turned on by a continuous signal. Turning off causes the piston to be returned to its initial position under pressure. Includes a manual operator as standard.

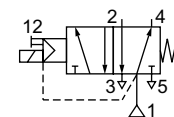
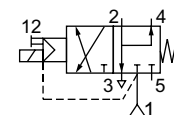

Medium	Air, neutral gases (filtered)
Differential pressure	2 - 10 bar
Permissible static pressure max.	10 bar
Operating temperature	-25 to 60 °C
Housing	Aluminium, anodised black
Sealant	NBR and PUR
Connection	G 1/4 (Port 1), G 1/8 (Port 3 and 5)
DN	6
Electrical connection	Connector socket Pg 9P, 3 x DIN 46244 / VDE 0580
Manual control	latching

3/2 and 5/2-way spool valve with NAMUR style interface

Art. No.	Type No.	Voltage	Flow rate l/min
103647	551.01	230 V, 50 Hz	700
103648	551.02	24 V DC	700



551.01

Flow regulator for NAMUR valves

Block-form flow regulator as an intermediate plate between the control valve and actuator acc. to the G 1/4 NAMUR standard.

3/2-way flow regulators:

Independent regulation of the forward and return strokes of a single-acting pneumatic actuator.

5/2-way flow regulators:

Regulation of the forward and return strokes of a double-acting pneumatic actuator.

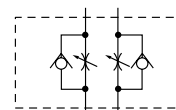
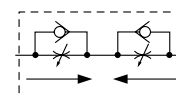

Medium	Air, neutral gases (filtered)
Operating temperature	-20 to 70 °C
Working pressure	0.5 - 10 bar
Housing	Aluminium anodised
Sealant	NBR
DN	5



551.51

Flow regulator for NAMUR valves

Art. No.	Type No.	Function	Operation	Flow rate l/min
103663	551.41	3-way	Knurled screw	650
103664	551.42	3-way	Screwdriver	650
103665	551.51	5-way	Knurled screw	650
103666	551.52	5-way	Screwdriver	650



551.52

Miniature solenoid valves 15 mm

3/2-way type

PLUS

Directly controlled 3/2-way solenoid valves specially designed for pneumatic applications. These valves are provided with a flange for assembly on an individual base or multiple manifold base. They feature a monostable manual operator. The scope of supply includes two fixing bolts and a flange gasket. The coils can be turned 180°.

Material	Plastic
Sealant	NBR, stainless steel
Medium	Filtered, unlubricated compressed air
Temperature range	-5 to 45 °C
Opening and closing times	10 to 12 ms (depending on pressure)
Coil power	2.5 W
Manual control	non-latching



MV 1051.2



MV 1051.3

Miniature solenoid valves, directly controlled, width 15 mm

Art. No.	Type No.	Connection	Voltage	Function	Plate on manual operator	Operating pressure bar	Nominal Ø mm	Width mm	Height mm
106642	MV 1051.2	Cable (30 cm)	24 V DC	3/2 NC	Silver	0 - 7	1.5	15.0	42.0
106643	MV 1051.3	For plug connector	24 V DC	3/2 NC	Silver	0 - 7	1.5	15.0	42.0
106644	MV 1052.2	Cable (30 cm)	12 V DC	3/2 NC	Silver	0 - 7	1.5	15.0	42.0
106645	MV 1052.3	For plug connector	12 V DC	3/2 NC	Silver	0 - 7	1.5	15.0	42.0
106646	MV 1061.2	Cable (30 cm)	24 V DC	3/2 NO	Black	0 - 5	1.5	15.0	42.0
106647	MV 1061.3	For plug connector	24 V DC	3/2 NO	Black	0 - 5	1.5	15.0	42.0
106648	MV 1062.2	Cable (30 cm)	12 V DC	3/2 NO	Black	0 - 5	1.5	15.0	42.0
106649	MV 1062.3	For plug connector	12 V DC	3/2 NO	Black	0 - 5	1.5	15.0	42.0

- ➔ Important:
The scope of supply does not include a connector. Please order separately.
- ➔ Accessories and manifold bases can be found on page 433

Accessories and manifold bases for miniature solenoid valves

Manifold base			
Art. No.	Type No.	Description	Length mm
106650	1099.01	Individual manifold base, M5	25.0
106651	1099.02	Multiple manifold base, 2-ports, M5	44.0
106652	1099.03	Multiple manifold base, 3 ports, M5	60.0
106653	1099.04	Multiple manifold base, 4 ports, M5	76.0
106654	1099.05	Multiple manifold base, 5 ports, M5	92.0
106655	1099.06	Multiple manifold base, 6 ports, M5	108.0
106656	1099.07	Multiple manifold base, 7 ports, M5	124.0
106657	1099.08	Multiple manifold base, 8 ports, M5	140.0
106658	1099.09	Multiple manifold base, 9 ports, M5	156.0
106659	1099.10	Multiple manifold base, 10 ports, M5	172.0

Accessories		
Art. No.	Type No.	Description
106660	1051.300	Plug conn. f. mini solenoid valve, PG 9 type C, DIN 43650 C
106661	1055.00	Fastener for manifold bases



1099.01



1099.06



1051.300



1055.00



Foot-operated valves

3/2- and 5/2-way

PLUS

Foot-operated valves, 3/2- and 5/2-way types, bistable or monostable (non-latching).

Operating pressure	2.5 - 10 bar
Temperature range	-10 to 60 °C



513.100



513.103

3/2-way foot-operated valve (monostable, non-latching, without foot guard)

Art. No.	Type No.	Connection	Flow rate at 6.3 bar and Δp 0.5 bar NI/min	Flow rate at 6.3 bar and Δp 1.0 bar NI/min	Symbol
106662	513.100	M5	60	95	20
106663	513.101	4 mm	60	95	20

3/2-way foot-operated valve (monostable, non-latching, with foot guard)

Art. No.	Type No.	Connection	Flow rate at 6.3 bar and Δp 0.5 bar NI/min	Flow rate at 6.3 bar and Δp 1.0 bar NI/min	Symbol
106664	513.102	M5	60	95	20
106665	513.103	4 mm	60	95	20

3/2-way foot-operated valve (bistable, latching, with foot guard)

Art. No.	Type No.	Connection	Flow rate at 6.3 bar and Δp 0.5 bar NI/min	Flow rate at 6.3 bar and Δp 1.0 bar NI/min	Symbol
106666	513.104	M5	60	95	21
106667	513.105	4 mm	60	95	21

5/2-way foot-operated valve (monostable, non-latching, with foot guard)

Art. No.	Type No.	Connection	Flow rate at 6.3 bar and Δp 0.5 bar NI/min	Flow rate at 6.3 bar and Δp 1.0 bar NI/min	Symbol
106668	513.106	G 1/4	640	840	22

5/2-way foot-operated valve (bistable, latching, with foot guard)

Art. No.	Type No.	Connection	Flow rate at 6.3 bar and Δp 0.5 bar NI/min	Flow rate at 6.3 bar and Δp 1.0 bar NI/min	Symbol
106669	513.107	G 1/4	640	840	23

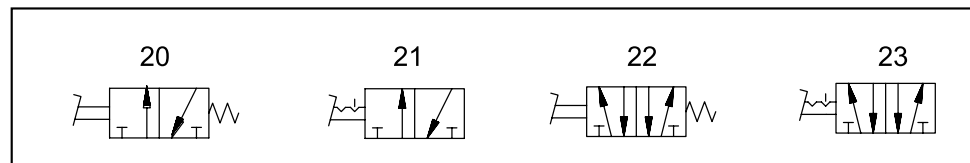

Valve terminals

modular valve system, »HDM« series

MAX

MAX

These compact valve terminals, with a maximum flow rate of 800 NI/min, can be individually adapted to the specific conditions of each application thanks to the wide range of functions and various input and intermediate plates.

Since each valve terminal is a customer-specific combination of a series of individual elements, the catalogue only lists the available input, intermediate and end plates as well as the different valve discs and the 25-pin multi-pole connectors.

Suitable for filtered, unlubricated or lubricated compressed air. If lubrication is used, it must be continuous.

Monostable (non-latching) version of manual control also available on request.

The operating pressure is based on the installed input plates.



Temperature range	-10 to 60 °C
Protection IP	IP 65
Piloting	Max. 16 (e.g. 16 spring return valves)
Power input	0.6 W per pilot
Manual control	latching

Input plate for HDM valve terminal

Art. No.	Type No.	Function	Connection	Operating pressure bar
106670	3-8	Standard, with interior control air	Multi-pole	3 - 7
106671	2-8	with external control air, two-supply circuit, Multipol, vacuum up to 10 bar	Multi-pole	-1 - 10
106672	P-3	Standard, with interior control air	With integrated Profibus DP	3 - 7
106673	P-2	with external control air, vacuum up to 10 bar	With integrated Profibus DP	-1 - 10



2-8

Valve disc for HDM valve terminal with 4 mm port

Art. No.	Type No.	Function	Flow rate NI/min
106674	I 4	2x 3/2-way, NC, monostable or 5/3-way, centre vented	200
106675	W 4	2x 3/2-way, NO, monostable or 5/3-way, centre aerated	200
106676	L 4	3/2-way, NC, monostable and 3/2-way, NO, monostable	200
106677	V 4	5/2-way, monostable	200
106678	F 4	5/2-way, monostable (only uses one PIN, Source 2 signals)	200
106679	K 4	5/2-way, bistable (double solenoid valve)	200
106680	O 4	5/3-way, centre closed	200



I 4

Valve disc for HDM valve terminal with 6 mm port

Art. No.	Type No.	Function	Flow rate NI/min
106681	I 6	2x 3/2-way, NC, monostable or 5/3-way, centre vented	500
106682	W 6	2x 3/2-way, NO, monostable or 5/3-way, centre aerated	500
106683	L 6	3/2-way, NC, monostable and 3/2-way, NO, monostable	500
106684	V 6	5/2-way, monostable	500
106685	F 6	5/2-way, monostable (only uses one PIN, Source 2 signals)	500
106686	K 6	5/2-way, bistable (double solenoid valve)	500
106687	O 6	5/3-way, centre closed	500



V 6

Valve terminals

modular valve system, »HDM« series

MAX



K 8



20



5



16



2269.100

Valve disc for HDM valve terminal with 8 mm port

Art. No.	Type No.	Function	Flow rate Nl/min
106688	I 8	2x 3/2-way, NC, monostable or 5/3-way, centre vented	800
106689	W 8	2x 3/2-way, NO, monostable or 5/3-way, centre aerated	800
106690	L 8	3/2-way, NC, monostable and 3/2-way, NO, monostable	800
106691	V 8	5/2-way, monostable	800
106692	F 8	5/2-way, monostable (only uses one PIN, Source 2 signals)	800
106693	K 8	5/2-way, bistable (double solenoid valve)	800
106694	O 8	5/3-way, centre closed	800

Intermediate plate for HDM valve terminal

Art. No.	Type No.	Function
106695	6	with additional supply and exhaust air
106696	7	with separated air intake (2+4 are separately pressurised)
106697	20	with separated exhaust (2+4 are separately exhausted)

End plate for HDM valve terminal

Art. No.	Type No.	Function
106698	5	blind (to close off the system)

Adapter for DIN rail

Art. No.	Type No.	Description
106699	16	Adapter for DIN rail

Electrical connection (multi-pole, 25-pin, IP 65)

Art. No.	Type No.	Description
106700	2269.100	IP 67 connector, 25-pin, with 1 m cable
106701	2269.250	IP 67 connector, 25-pin, with 2.5 m cable
106702	2269.500	IP 67 connector, 25-pin, with 5 m cable

Typical valve terminal design:

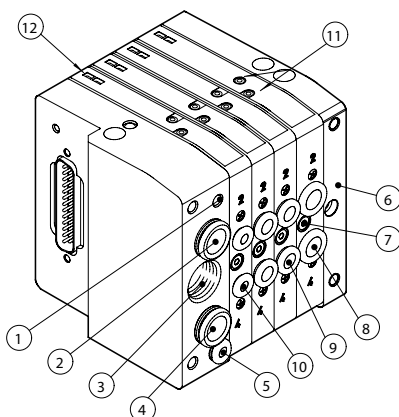

- 1. Exhaust – solenoid pilot M5
- 2. Valve supply – port 1 (10 mm)
- 3. Exhaust port G 3/8
- 4. Valve supply – port 1-1 (10 mm)
- 5. External pilot (4 mm)
- 6. Blind end plate
- 7. Screw for valve wall mounting (second screw on rear)
- 8. Utility port (8 mm)
- 9. Utility port (6 mm)
- 10. Utility port (4 mm)
- 11. Manual override
- 12. LED

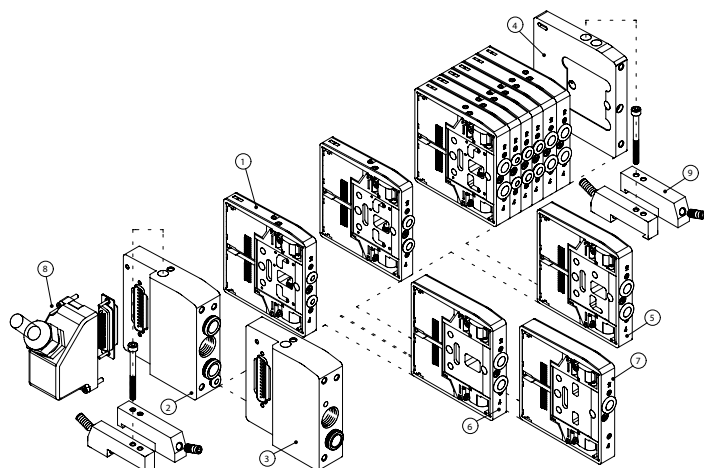

- 1. Valve
- 2. Input plate with external pilots
- 3. Input plate / standard
- 4. Blind end plate
- 5. Intermediate plate (additional pilots and exhausts)
- 6. Intermediate plate (separate pilot)
- 7. Intermediate plate (separate exhaust)
- 8. 25-pole connector IP65
- 9. Adapter for DIN rail

THE NUMBERS PERMIT RAPID IDENTIFICATION OF THE FUNCTION AND ASSEMBLY POSITION OF THE SINGLE ELEMENTS REPRESENTED ABOVE

Electrical connection (Installation notes)

The pin assignment of the multi-pin plug

PIN 25 = Ground (can in this terminal any + or -)

Pin assignment of 25- pin connector (V - valve to position B)

	A	B	C	D
●	1	3	4	6
●	2	*)	5	7

Pin assignment of 25- pin connector (V - valve to position B)

*)Valves of the type V evidence only one pin but Valves type F use 2 pins

	A	B	C	D
●	1	3	5	7
●	2	4*)	6	8

Function V = F function (5/2 -way , spring return)

Connection assignment for the socket cable

25 PIN	number of electrical contact	Color of the corresponding conductor	number of electrical contact	Color of the corresponding conductor	number of electrical contact	Color of the corresponding conductor
	1	blue/black	10	brown/white	19	yellow/black
2	red/brown	11	red/orange	20	white	
3	white/black	12	light blue	21	blue/white	
4	red/blue	13	yellow/white	22	brown	
5	black/orange	14	yellow	23	green/white	
6	yellow/red	15	red/green	24	red	
7	black/brown	16	orange	25	green/black	
8	white/red	17	orange/white			
9	red/black	18	green			

Pneumatic logic elements

MAX

Pneumatic logic elements are available with five different functions: OR, AND, NOT, YES, MEMORY. All elements have an adapter for the Ω -rail (DIN EN 50022) integral with the body.

Material	Technopolymer
Spool	Aluminium
Sealant	NBR
Temperature range	-10 to 60 °C
Flow rate	100 l/min (at 6 bar and $\Delta p = 1$ bar)



W 36-1

Pneumatic logic elements

Art. No.	Type No.	Function	Working pressure bar	Reset	Pilot pressure bar	For tube O.D. mm	Nominal \varnothing mm	Length mm	Height mm
106705	W 36-1	OR	1.5 - 8	by compressed air	to	4	2.7	38.5	40.0
106706	W 36-2	AND	1.5 - 8	by compressed air	to	4	2.7	38.5	40.0
106707	W 36-3	NOT	0.4 - 6	by mechanical spring	to	4	2.7	55.2	40.0
106708	W 36-4	YES	0 - 8	by mechanical spring	1.5 to 8	4	2.7	55.2	40.0
106709	W 36-5	MEMORY	0 - 8	by compressed air	1.5 to 8	4	2.7	89.5	41.0

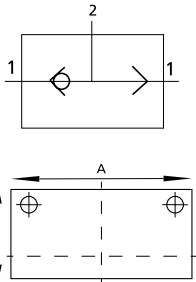
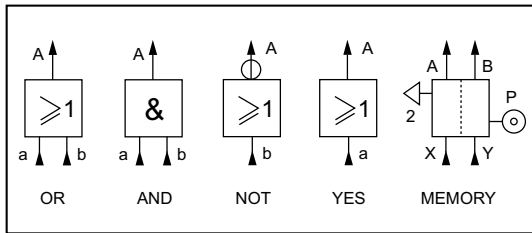

OR valves

MAX

The valve has two inlets and one outlet. A signal appears at the outlet when the left or right inlet is pressurised. If the pressure at the two inlets is different, the stronger of the two signals appears at the outlet.

Operating pressure	2 - 10 bar
Temperature range	-10 to 80 °C
Valve body	Aluminium
Sealant	NBR
Ball	Stainless steel



ODER-14

OR valve, aluminium

Art. No.	Type No.	Thread	Flow rate at 6.3 bar and Δp 1.0 bar NI/min	A mm	B mm
106703	ODER-18	3 x G 1/8	500	36.0	20.0
106704	ODER-14	3 x G 1/4	1300	43.0	25.0

Pneumatic logic element: Timer

MAX

The value of the signal output delay can be steplessly adjusted by rotating a knob.
 NO or NC function, depending on the connection.
 The maximum delay time can be increased by unscrewing a plug and connecting the port to an external tank.

Material	Anodised aluminium / technopolymer
Internal parts	Brass / technopolymer
Working pressure	2.5 - 8 bar
Reset	By mechanical spring
Delay setting range	0 to 30 (at 6 bar) sec.
Signal shut-off time	< 0.1 s
Repeatability	+/- 0.4 s
Pressure indication	Via orange pin

Timer				
Art. No.	Type No.	Function	Length mm	Height mm
106710	W 36-6	Timer	107.0	49.0

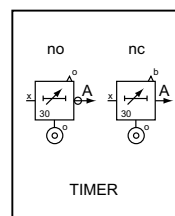

Two-hand safety valve

with dual manual control valve and pushbutton

MAX

This pushbutton panel according to EN574 Type III A is comprised of a dual manual control valve with a housing and manifold. The valve only generates an output signal if two synchronised input signals are received within < 0.4 sec. If one input signal is interrupted, the output signal is interrupted as well. An emergency stop valve with a mushroom pushbutton is included. The housing can be screwed to the wall in any position; the valve manifold can optionally be supplied without the housing and with a DIN bar adapter.

Applications: Two-hand safety valve for start-of-cycle control on a pneumatically operated machine.

Connection	Push-in fitting for 4 mm pipe
Medium	Filtered, unlubricated compressed air
Synchronisation, max. time between two signals	0.4 sec.
Operating pressure	2.5 - 8 bar
Temperature range	-10 to 60 °C
Flow rate at 6 bar and Δp 1.0 bar	85 NI/min
Operation	Pneumatic



Complete pushbutton panel		
Art. No.	Type No.	Description
106711	SK-85	Complete pushbutton panel with safety valve

Two-hand safety valve without housing		
Art. No.	Type No.	Description
106712	SV-85	Two-hand safety valve without housing
106713	SV-A	Valve adapter for DIN bar



Inline function connectors

»lineonline« series

A carefully selected assortment of products for installation in pneumatic circuits. These small, highly efficient components allow all pneumatic functions to be implemented anywhere in the circuit.

The series has an ultramodular design.
All components can be installed
in parallel
in series
in a mixed parallel/serial configuration.

Available as
pipe/pipe connection with two plug connectors
thread/pipe connection with one plug connector and one nickel-plated brass thread.

Installation
Wall mounting (housing with drilled holes)
Bracket mounting (mounting bracket available as an accessory)
Panel mounting (with bracket or lock nut)

Body	Technopolymer
Sealant	NBR
Internal parts	Nickel-plated brass, brass, technopolymer, stainless steel
Temperature range	-20 to 60 °C
Pneumatic symbols	On housing

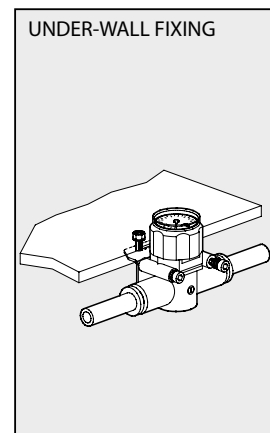
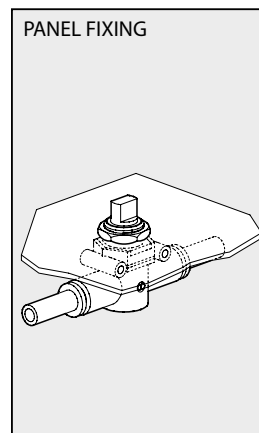
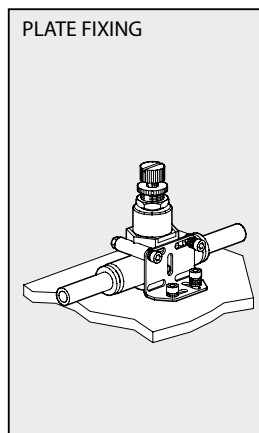
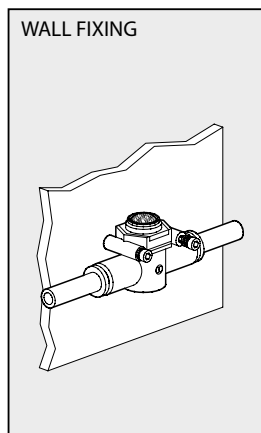
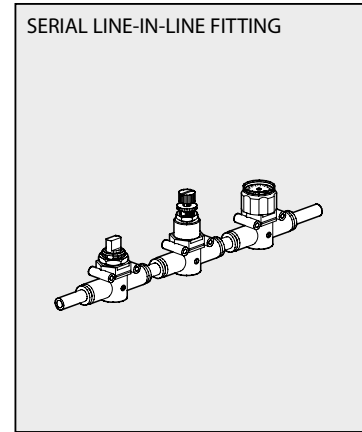
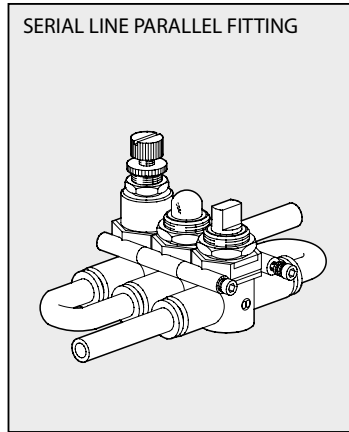
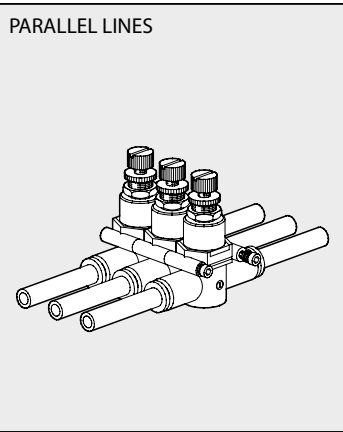

Bidirectional flow control valves / Unidirectional flow control valves

»lineonline« series

PLUS

Control the air intake and thus the speed of pneumatic units.

Max. operating pressure	10 bar
Adjustment	Manual or screwdriver

Unidirectional flow control valve, flow at one end, pipe - pipe, outgoing air restriction

Art. No.	Type No.	For pipe Ø mm	Flow rate at 6.3 bar NI/min	A mm	B mm	I mm
106714	410-4	4	155	42.0	35.0	12.7
106715	410-6	6	450	49.4	40.0	14.6
106716	410-8	8	850	57.3	49.0	18.7

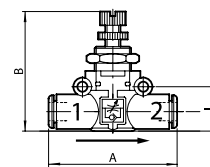

410-6

Unidirectional flow control valve, flow at one end (cylinder assembly), thread - pipe, outgoing air restriction

Art. No.	Type No.	Thread	For pipe Ø mm	Flow rate at 6.3 bar NI/min	A mm	B mm	I mm
106717	411.005-4	M5	4	155	47.7	35.0	12.7
106718	411.018-4	G 1/8	4	155	51.6	35.0	12.7
106719	411.018-6	G 1/8	6	450	58.5	40.0	14.6
106720	411.018-8	G 1/8	8	850	61.5	40.0	14.6
106721	411.014-6	G 1/4	6	450	66.2	49.0	18.7
106722	411.014-8	G 1/4	8	850	70.6	49.0	18.7
106723	411.038-8	G 3/8	8	850	72.2	49.0	18.7

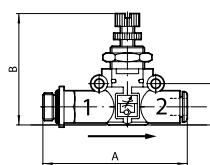

411.018-6

Unidirectional flow control valve, flow at one end (valve assembly), pipe - thread, incoming air restriction

Art. No.	Type No.	Thread	For pipe Ø mm	Flow rate at 6.3 bar NI/min	A mm	B mm	I mm
106724	412.005-4	M5	4	155	47.7	35.0	12.7
106725	412.018-4	G 1/8	4	155	51.6	35.0	12.7
106726	412.018-6	G 1/8	6	450	58.5	40.0	14.6
106727	412.018-8	G 1/8	8	850	61.5	40.0	14.6
106728	412.014-6	G 1/4	6	450	66.2	49.0	18.7
106729	412.014-8	G 1/4	8	850	70.6	49.0	18.7
106730	412.038-8	G 3/8	8	850	72.2	49.0	18.7

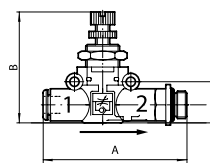

412.018-6

Bidirectional flow control valve, flow at both ends, pipe - pipe, bothway compressed air supply

Art. No.	Type No.	For pipe Ø mm	Flow rate at 6.3 bar NI/min	A mm	B mm	I mm
106731	413-4	4	155	42.0	35.0	12.7
106732	413-6	6	450	49.4	40.0	14.6
106733	413-8	8	850	57.3	49.0	18.7

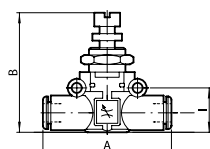

413-6

Bidirectional flow control valve, flow at both ends, thread - pipe, bothway compressed air supply

Art. No.	Type No.	Thread	For pipe Ø mm	Flow rate at 6.3 bar NI/min	A mm	B mm	I mm
106734	414.005-4	M5	4	155	47.7	35.0	12.7
106735	414.018-4	G 1/8	4	155	51.6	35.0	12.7
106736	414.018-6	G 1/8	6	450	58.5	40.0	14.6
106737	414.018-8	G 1/8	8	850	61.5	40.0	14.6
106738	414.014-6	G 1/4	6	450	66.2	49.0	18.7
106739	414.014-8	G 1/4	8	850	70.6	49.0	18.7
106740	414.038-8	G 3/8	8	850	72.2	49.0	18.7

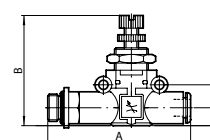

411-018-6

→ Accessories at page 450

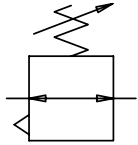

Pressure regulators

»lineonline« series

PLUS ||

Particularly suitable for installation between the valve and cylinder and as a pressure regulator in secondary branches of the pneumatic system. The regulator is fitted with a pressure limiting valve for overpressure exhaust.

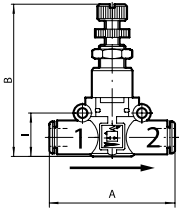

420-6

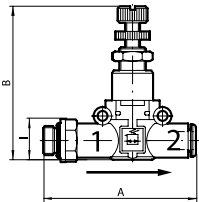

421.018-6

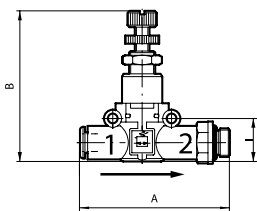

422.018-6

Operating pressure	2 - 10 bar
Control range	1 - 8 bar

Pressure regulators, pipe - pipe

Art. No.	Type No.	For pipe Ø mm	Flow rate at 6.3 bar NI/min	A mm	B mm	I mm
106741	420-6	6	400	49.4	52.0	14.6
106742	420-8	8	600	57.3	58.0	18.7

Pressure regulators, thread (input) - pipe (output)

Art. No.	Type No.	Thread	For pipe Ø mm	Flow rate at 6.3 bar NI/min	A mm	B mm	I mm
106743	421.018-6	G 1/8	6	400	58.5	52.0	14.6
106744	421.018-8	G 1/8	8	600	61.5	52.0	14.6
106745	421.014-6	G 1/4	6	400	66.2	58.0	18.7
106746	421.014-8	G 1/4	8	600	70.6	58.0	18.7
106747	421.038-8	G 3/8	8	600	72.2	58.0	18.7

Pressure regulators, pipe (input) - thread (output)

Art. No.	Type No.	Thread	For pipe Ø mm	Flow rate at 6.3 bar NI/min	A mm	B mm	I mm
106748	422.018-6	G 1/8	6	400	58.5	52.0	14.6
106749	422.018-8	G 1/8	8	600	61.5	52.0	14.6
106750	422.014-6	G 1/4	6	400	66.2	58.0	18.7
106751	422.014-8	G 1/4	8	600	70.6	58.0	18.7
106752	422.038-8	G 3/8	8	600	72.2	58.0	18.7

→ Accessories at page 450

Pressure gauges

»lineonline« series

PLUS

Though small in size, these pressure gauges ensure accurate reading.

Max. operating pressure	12 bar
Precision	+/- 4 % of full-scale value
Measuring range	0 to 12 bar

Pressure gauge, pipe - pipe

Art. No.	Type No.	For pipe Ø mm	A mm	B mm	I mm
106753	460-4	4	41.8	36.1	12.8
106754	460-6	6	49.0	35.0	14.6
106755	460-8	8	57.2	41.1	18.7

Pressure gauge, thread (input) - pipe (output)

Art. No.	Type No.	Thread	For pipe Ø mm	A mm	B mm	I mm
106756	461.005-4	M5	4	47.7	36.1	12.8
106757	461.018-4	G 1/8	4	51.5	36.1	12.8
106758	461.018-6	G 1/8	6	58.3	35.0	14.6
106759	461.018-8	G 1/8	8	66.4	41.1	18.7
106760	461.014-6	G 1/4	6	61.3	35.0	14.6
106761	461.014-8	G 1/4	8	70.8	41.1	18.7
106762	461.038-8	G 3/8	8	72.4	41.1	18.7

→ Accessories at page 450

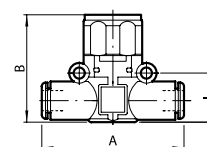

460-6

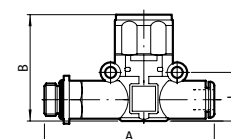

461.018-6

Quick-exhaust valves

»lineonline« series

PLUS

Exhaust can be silenced by a stainless steel silencer or conveyed using a push-in fitting with an air exhaust device.

Operating pressure	1 - 10 bar
--------------------	------------

Quick-exhaust valve, conveyed exhaust, pipe - pipe

Art. No.	Type No.	For pipe Ø mm	Flow rate at 6.3 bar NI/min	A mm	B mm	I mm
106763	430-4	4	50	41.8	25.8	12.8
106764	430-6	6	270	49.0	30.2	14.6
106765	430-8	8	400	57.2	35.9	18.7

Quick-exhaust valve, with silencer, pipe - pipe

Art. No.	Type No.	For pipe Ø mm	Flow rate at 6.3 bar NI/min	A mm	B mm	I mm
106766	431-4	4	50	41.8	19.8	12.8
106767	431-6	6	270	49.0	25.5	14.6
106768	431-8	8	400	57.2	31.5	18.7

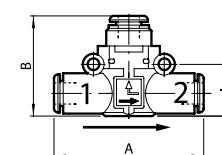
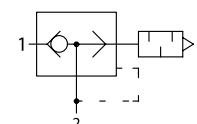

430-6

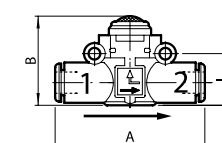

431-6



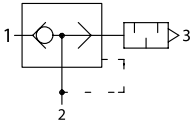

Quick-exhaust valves

»lineonline« series

PLUS

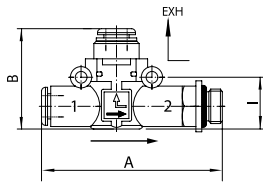

432.018-6

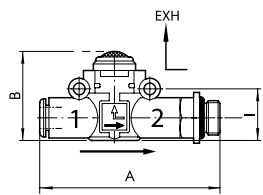

433.018-6

Quick-exhaust valve, conveyed exhaust, pipe (input) - thread (output)

Art. No.	Type No.	Thread	For pipe Ø mm	Flow rate at 6.3 bar NI/min	A mm	B mm	I mm
106769	432.005-4	M5	4	50	47.7	25.8	12.8
106770	432.018-4	G 1/8	4	50	50.6	25.8	12.8
106771	432.018-6	G 1/8	6	270	58.5	30.2	14.6
106772	432.018-8	G 1/8	8	400	66.2	35.9	18.7
106773	432.014-6	G 1/4	6	270	61.5	30.2	14.6
106774	432.014-8	G 1/4	8	400	70.6	35.9	18.7
106775	432.038-8	G 3/8	8	400	72.2	35.9	18.7

Quick-exhaust valve, with silencer, pipe (input) - thread (output)

Art. No.	Type No.	Thread	For pipe Ø mm	Flow rate at 6.3 bar NI/min	A mm	B mm	I mm
106776	433.005-4	M5	4	50	46.7	19.8	12.8
106777	433.018-4	G 1/8	4	50	50.6	19.8	12.8
106778	433.018-6	G 1/8	6	270	58.5	25.5	14.6
106779	433.018-8	G 1/8	8	400	66.2	31.5	18.7
106780	433.014-6	G 1/4	6	270	61.5	25.5	14.6
106781	433.014-8	G 1/4	8	400	70.6	31.5	18.7
106782	433.038-8	G 3/8	8	400	72.2	31.5	18.7

➔ Accessories at page 450



Pressure indicators

»lineonline« series

PLUS

When there is no pressure, the clear bell looks empty.
When there is pressure, a red signal appears.

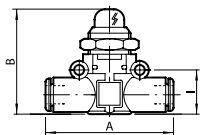

470-6

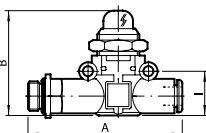

471.018-6

Operating pressure 2 - 10 bar

Pressure indicators, pipe - pipe

Art. No.	Type No.	For pipe Ø mm	A mm	B mm	I mm
106783	470-6	6	49.4	37.0	14.6
106784	470-8	8	57.3	41.0	18.7

Pressure indicators, thread (input) - pipe (output)

Art. No.	Type No.	Thread	For pipe Ø mm	A mm	B mm	I mm
106785	471.018-6	G 1/8	6	58.5	37.0	14.6
106786	471.018-8	G 1/8	8	66.2	41.0	18.7
106787	471.014-6	G 1/4	6	61.5	37.0	14.6
106788	471.014-8	G 1/4	8	70.6	41.0	18.7
106789	471.038-8	G 3/8	8	72.2	41.0	18.7

➔ Accessories at page 450

3/2-way valve, pneumatically actuated

»lineonline« series

PLUS

The valves can only be used with compressed air at port 1 owing to their function.

Max. operating pressure	10 bar
Control air port	4 mm

3/2-way valve, pipe - pipe

Art. No.	Type No.	For pipe Ø mm	Function	Flow rate at 6.3 bar and Δp 1.0 bar NI/min	A mm	B mm	l mm
106790	490-6	6	NC	400	49.4	43.2	14.6
106791	490-8	8	NC	790	57.3	49.7	18.7

3/2-way valve, thread (input) - pipe (output)

Art. No.	Type No.	Thread	For pipe Ø mm	Function	Flow rate at 6.3 bar and Δp 1.0 bar NI/min	A mm	B mm	l mm
106792	491.018-6	G 1/8	6	NC	400	58.5	43.2	14.6
106793	491.018-8	G 1/8	8	NC	790	66.2	49.7	18.7
106794	491.014-6	G 1/4	6	NC	400	61.5	43.2	14.6
106795	491.014-8	G 1/4	8	NC	790	70.6	49.7	18.7
106796	491.038-8	G 3/8	8	NC	790	72.2	49.7	18.7

3/2-way valve, pipe (input) - thread (output)

Art. No.	Type No.	Thread	For pipe Ø mm	Function	Flow rate at 6.3 bar and Δp 1.0 bar NI/min	A mm	B mm	l mm
106797	492.018-6	G 1/8	6	NC	400	58.5	43.2	14.6
106798	492.018-8	G 1/8	8	NC	790	66.2	49.7	18.7
106799	492.014-6	G 1/4	6	NC	400	61.5	43.2	14.6
106800	492.014-8	G 1/4	8	NC	790	70.6	49.7	18.7
106801	492.038-8	G 3/8	8	NC	790	72.2	49.7	18.7

➔ Accessories at page 450

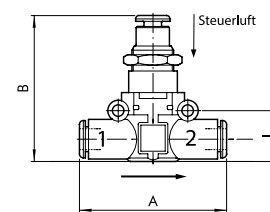
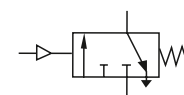

490-6

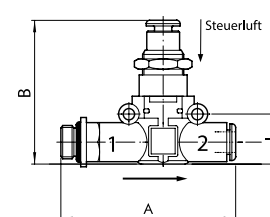

491.018-6

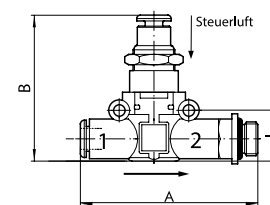

492.018-6



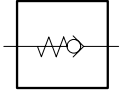

Unidirectional valves

»lineonline« series

PLUS

These valves ensure that compressed air only flows in one (i.e. the desired) direction. The valve closes when inlet pressure is lost and maintains the working pressure that is present downstream.

Operating pressure	0.5 - 12 bar
--------------------	--------------

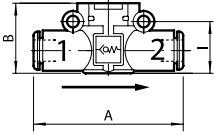

440-6

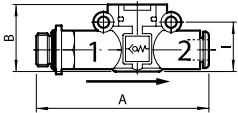

441.018-6

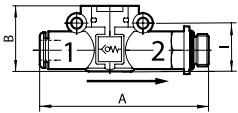

442.018-6

Unidirectional valve, pipe - pipe

Art. No.	Type No.	For pipe Ø mm	Flow rate at 6.3 bar and Δp 1.0 bar NI/min	A mm	B mm	I mm
106802	440-4	4	80	41.8	17.5	12.8
106803	440-6	6	320	49.0	20.0	14.6
106804	440-8	8	480	57.2	26.0	18.7

Unidirectional valve, thread (input) - pipe (output)

Art. No.	Type No.	Thread	For pipe Ø mm	Flow rate at 6.3 bar and Δp 1.0 bar NI/min	A mm	B mm	I mm
106805	441.005-4	M5	4	80	47.7	17.5	12.8
106806	441.018-4	G 1/8	4	80	50.6	17.5	12.8
106807	441.018-6	G 1/8	6	320	58.3	20.0	14.6
106808	441.018-8	G 1/8	8	480	66.4	26.0	18.7
106809	441.014-6	G 1/4	6	320	61.3	20.0	14.6
106810	441.014-8	G 1/4	8	480	70.8	26.0	18.7
106811	441.038-8	G 3/8	8	480	72.4	26.0	18.7

Unidirectional valve, pipe (input) - thread (output)

Art. No.	Type No.	Thread	For pipe Ø mm	Flow rate at 6.3 bar and Δp 1.0 bar NI/min	A mm	B mm	I mm
106812	442.005-4	M5	4	80	47.7	17.5	12.8
106813	442.018-4	G 1/8	4	80	50.6	17.5	12.8
106814	442.018-6	G 1/8	6	320	58.3	20.0	14.6
106815	442.018-8	G 1/8	8	480	66.4	26.0	18.7
106816	442.014-6	G 1/4	6	320	61.3	20.0	14.6
106817	442.014-8	G 1/4	8	480	70.8	26.0	18.7
106818	442.038-8	G 3/8	8	480	72.4	26.0	18.7

→ Accessories at page 450

Pneumatically piloted stop valves

»lineonline« series

PLUS

For stopping and positioning the cylinder. If a signal is present at the pilot port, air can flow to and from the cylinder. If no pilot signal is present, the cylinder exhaust port is shut off by the stop valve. The cylinder is stopped.

Max. operating pressure	10 bar
Control air port	4 mm

Pneumatically piloted stop valve, pipe - pipe

Art. No.	Type No.	For pipe Ø mm	Flow rate at 6.3 bar and Δp 1.0 bar NI/min	A mm	B mm	l mm
106819	493-06	6	400	49.4	43.2	14.6
106820	493-08	8	790	57.3	49.7	18.7

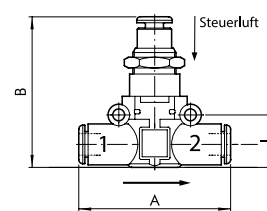
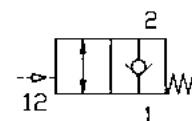

493.06

Pneumatically piloted stop valve, thread (input) - pipe (output)

Art. No.	Type No.	Thread	For pipe Ø mm	Flow rate at 6.3 bar and Δp 1.0 bar NI/min	A mm	B mm	l mm
106821	494.018-6	G 1/8	6	400	58.5	43.2	14.6
106822	494.018-8	G 1/8	8	790	66.2	49.7	18.7
106823	494.014-6	G 1/4	6	400	61.5	43.2	14.6
106824	494.014-8	G 1/4	8	790	70.6	49.7	18.7
106825	494.038-8	G 3/8	8	790	72.2	49.7	18.7

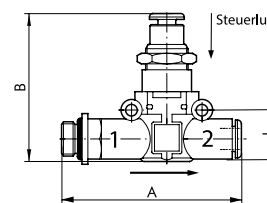

494.018-6

Pneumatically piloted stop valve, pipe (input) - thread (output)

Art. No.	Type No.	Thread	For pipe Ø mm	Flow rate at 6.3 bar and Δp 1.0 bar NI/min	A mm	B mm	l mm
106826	495.018-6	G 1/8	6	400	58.5	43.2	14.6
106827	495.018-8	G 1/8	8	790	66.2	49.7	18.7
106828	495.014-6	G 1/4	6	400	61.5	43.2	14.6
106829	495.014-8	G 1/4	8	790	70.6	49.7	18.7
106830	495.038-8	G 3/8	8	790	72.2	49.7	18.7

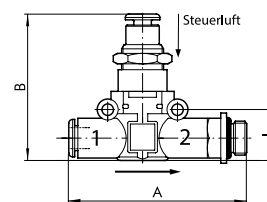

495.018-6

→ Accessories at page 450

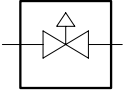

Shut-off valves

»lineonline« series

PLUS

2/2-way type. For manual opening and closing of compressed air pipes.

Max. operating pressure 10 bar

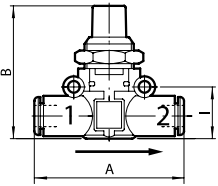

450-6

Shut-off valve, pipe - pipe

Art. No.	Type No.	For pipe Ø mm	Flow rate at 6.3 bar and Δp 1.0 bar NI/min	A mm	B mm	I mm
106831	450-6	6	280	49.0	41.0	14.6
106832	450-8	8	470	57.2	46.0	18.7

Shut-off valve, thread (input) - pipe (output)

Art. No.	Type No.	Thread	For pipe Ø mm	Flow rate at 6.3 bar and Δp 1.0 bar NI/min	A mm	B mm	I mm
106833	451.018-6	G 1/8	6	280	58.3	41.0	14.6
106834	451.018-8	G 1/8	8	470	66.4	46.0	18.7
106835	451.014-6	G 1/4	6	280	61.3	41.0	14.6
106836	451.014-8	G 1/4	8	470	70.8	46.0	18.7
106837	451.038-8	G 3/8	8	470	72.4	46.0	18.7

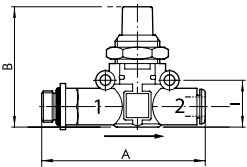

451.018-6

Shut-off valve, pipe (input) - thread (output)

Art. No.	Type No.	Thread	For pipe Ø mm	Flow rate at 6.3 bar and Δp 1.0 bar NI/min	A mm	B mm	I mm
106838	452.018-6	G 1/8	6	280	58.3	41.0	14.6
106839	452.018-8	G 1/8	8	470	66.4	46.0	18.7
106840	452.014-6	G 1/4	6	280	61.3	41.0	14.6
106841	452.014-8	G 1/4	8	470	70.8	46.0	18.7
106842	452.038-8	G 3/8	8	470	72.4	46.0	18.7

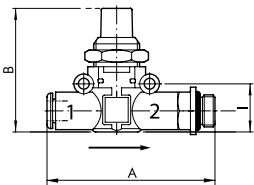

452.018-6

➔ Accessories at page 450

3/2-way Solenoid valves

»lineonline« series

PLUS

Though small in size, these valves are solenoid-piloted and feature very high performance. Each valve comes complete with a monostable manual control and LED. Exhaust can be damped with a silencer or conveyed via a pipe fitting. Function corresponds to the normal position of the valve.

Operating pressure	2.5 - 7 bar
Operating voltage	24 V DC
Power input	1.2 W

3/2-way Solenoid valve, exhaust damped by silencer, pipe - pipe

Art. No.	Type No.	For pipe Ø mm	Function	Flow rate at 6.3 bar and Δp 1.0 bar NI/min	A mm	B mm	I mm
106843	480-6	6	NC	380	49.0	57.5	14.6
106844	480-8	8	NC	700	57.2	63.5	18.7
106845	481-6	6	NO	380	49.0	57.5	14.6
106846	481-8	8	NO	700	57.2	63.5 </td <td>18.7</td>	18.7

3/2-way Solenoid valve, conveyed exhaust, pipe - pipe

Art. No.	Type No.	For pipe Ø mm	Function	Flow rate at 6.3 bar and Δp 1.0 bar NI/min	A mm	B mm	I mm
106847	482-6	6	NC	380	49.0	57.5	14.6
106848	482-8	8	NC	700	57.2	63.5	18.7
106849	483-6	6	NO	380	49.0	57.5	14.6
106850	483-8	8	NO	700	57.2	63.5	18.7

3/2-way Solenoid valve, exhaust damped by silencer, pipe (input) - thread (output)

Art. No.	Type No.	Thread	For pipe Ø mm	Function	Flow rate at 6.3 bar and Δp 1.0 bar NI/min	A mm	B mm	I mm
106851	484.018-6	G 1/8	6	NC	380	58.3	57.5	14.6
106852	484.018-8	G 1/8	8	NC	700	66.4	63.5	18.7
106853	484.014-6	G 1/4	6	NC	380	61.3	57.5	14.6
106854	484.014-8	G 1/4	8	NC	700	70.8	63.5	18.7
106855	484.038-8	G 3/8	8	NC	700	72.4	63.5	18.7
106856	485.018-6	G 1/8	6	NO	380	58.3	57.5	14.6
106857	485.018-8	G 1/8	8	NO	700	66.4	63.5	18.7
106858	485.014-6	G 1/4	6	NO	380	61.3	57.5	14.6
106859	485.014-8	G 1/4	8	NO	700	70.8	63.5	18.7
106860	485.038-8	G 3/8	8	NO	700	72.4	63.5	18.7

3/2-way Solenoid valve, conveyed exhaust, pipe (input) - thread (output)

Art. No.	Type No.	Thread	For pipe Ø mm	Function	Flow rate at 6.3 bar and Δp 1.0 bar NI/min	A mm	B mm	I mm
106861	486.018-6	G 1/8	6	NC	380	58.3	57.5	14.6
106862	486.018-8	G 1/8	8	NC	700	66.4	63.5	18.7
106863	486.014-6	G 1/4	6	NC	380	61.3	57.5	14.6
106864	486.014-8	G 1/4	8	NC	700	70.8	63.5	18.7
106865	486.038-8	G 3/8	8	NC	700	72.4	63.5	18.7
106866	487.018-6	G 1/8	6	NO	380	58.3	57.5	14.6
106867	487.018-8	G 1/8	8	NO	700	66.4	63.5	18.7
106868	487.014-6	G 1/4	6	NO	380	61.3	57.5	14.6
106869	487.014-8	G 1/4	8	NO	700	70.8	63.5	18.7
106870	487.038-8	G 3/8	8	NO	700	72.4	63.5	18.7

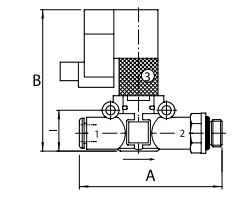
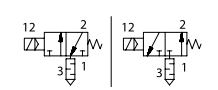
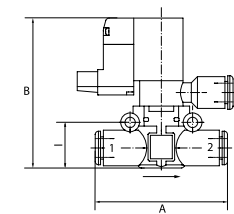
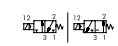
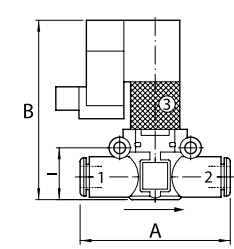
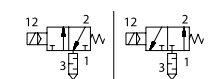

➔ Accessories at page 450



Accessories lineonline

Accessories

Art. No.	Type No.	Description
106871	4888	Mounting bracket, suitable for all components
106872	4888-6	U-shaped element for 6 mm pipe, for serial installation
106873	4888-8	U-shaped element for 8 mm pipe, for serial installation
106874	4889	U-shaped element for 8 mm pipe, for serial installation

Unidirectional flow control valves

adjustable with slotted-head screwdriver

PLUS

For throttling flow rates and regulating the piston speed of cylinders. Small dimensions, ideal for tight spaces. To be screwed directly into the valve or cylinder. The set flow rate can be locked via the lock nut in the version with knurled screw. The variants in banjo bolt construction can be rotated during assembly and are fixed after tightening. The variants with plug-in connector, rotated can also be rotated freely after assembly. The seals and lubricants used are silicone-free.

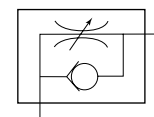

Operating pressure	0 - 10 bar
Temperature range	-20 to 80 °C
Body	Nickel-plated brass
Sealant	NBR
Captive seals	Polyamide glass fibre-reinforced (only parts in banjo bolt construction)

Unidirectional flow control valve, supply air throttle (V), screw connection, banjo bolt construction

Art. No.	Type No.	Thread	Connection	a/f mm	B mm	C mm
106875	357.005-M5	M5	M5 IG	8	24.5	11.5
106876	357.018-1/8	G 1/8	G 1/8 IG	14	32.0	16.0
106877	357.014-1/4	G 1/4	G 1/4 IG	17	40.0	22.0
106878	357.038-3/8	G 3/8	G 3/8 IG	20	50.0	26.0

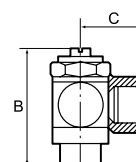

357.005-M5

Unidirectional flow control valve, supply air throttle (V), quick-lock screw fitting, banjo bolt construction

Art. No.	Type No.	Thread	For hose mm	a/f mm	B mm	C mm
106879	357.005-4	M5	4 / 2.5	8	24.5	18.0
106880	357.005-5	M5	5 / 3	8	24.5	19.0
106881	357.005-6	M5	6 / 4	8	24.5	19.0
106882	357.018-5	G 1/8	5 / 3	14	32.0	23.0
106883	357.018-6	G 1/8	6 / 4	14	32.0	25.0
106884	357.018-8	G 1/8	8 / 6	14	32.0	25.0
106885	357.014-6	G 1/4	6 / 4	17	40.0	26.5
106886	357.014-8	G 1/4	8 / 6	17	40.0	27.5
106887	357.014-10	G 1/4	10 / 8	17	40.0	28.5
106888	357.038-10	G 3/8	10 / 8	20	50.0	30.5

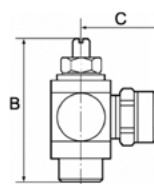

357.014-6

Unidirectional flow control valve, supply air throttle (V), plug-in connector, rotating

Art. No.	Type No.	Thread	For hose mm	a/f mm	B mm	C mm
106280 NEW	342.005-4-D	M5	4	6	25.5	18.5
106281 NEW	342.005-6-D	M5	6	6	25.5	21.5
106282 NEW	342.018-4-D	G 1/8	4	9	31.8	20.5
109971 NEW	342.018-6-D	G 1/8	6	9	31.8	22.5
110107 NEW	342.018-8-D	G 1/8	8	9	31.8	23.5
112972 NEW	342.014-6-D	G 1/4	6	10	39.5	24.0
112978 NEW	342.014-8-D	G 1/4	8	10	39.5	24.5
112982 NEW	342.014-10-D	G 1/4	10	10	39.5	27.0
113033 NEW	342.038-8-D	G 3/8	8	14	50.0	26.5
113726 NEW	342.038-10-D	G 3/8	10	14	50.0	29.0

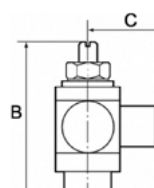

342.018-6-D

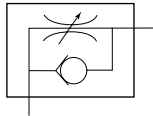

Unidirectional flow control valves

adjustable with knurled screw

PLUS

For throttling flow rates and regulating the piston speed of cylinders. Small dimensions, ideal for tight spaces. To be screwed directly into the valve or cylinder. The set flow rate can be locked via the lock nut in the version with knurled screw. The variants in banjo bolt construction can be rotated during assembly and are fixed after tightening. The variants with plug-in connector, rotated can also be rotated freely after assembly. The seals and lubricants used are silicone-free.

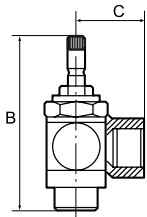

339.005-M5

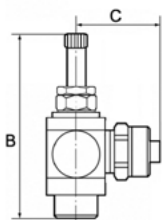

339.014-6

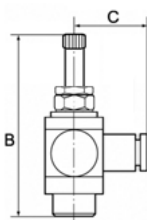

341.018-6-D

Operating pressure	0 - 10 bar
Temperature range	-20 to 80 °C
Body	Nickel-plated brass
Sealant	NBR
Captive seals	Polyamide, glass fibre-reinforced (only parts in banjo bolt construction)

Unidirectional flow control valve, supply air throttle (V), screw connection, banjo bolt construction

Art. No.	Type No.	Thread	Connection	a/f mm	B mm	C mm
106898	339.005-M5	M5	M5 female thread	8	38.9	11.5
106899	339.018-1/8	G 1/8	G 1/8 female thread	14	42.4	16.0
106900	339.014-1/4	G 1/4	G 1/4 female thread	17	51.0	22.0
106901	339.038-3/8	G 3/8	G 3/8 female thread	20	63.0	26.0

Unidirectional flow control valve, supply air throttle (V), quick-lock screw fitting, banjo bolt construction

Art. No.	Type No.	Thread	For hose mm	a/f mm	B mm	C mm
106902	339.005-4	M5	4 / 2.5	8	38.9	18.0
106903	339.005-5	M5	5 / 3	8	38.9	19.0
106904	339.005-6	M5	6 / 4	8	38.9	19.0
106905	339.018-5	G 1/8	5 / 3	14	42.4	23.0
106906	339.018-6	G 1/8	6 / 4	14	42.4	25.0
106907	339.018-8	G 1/8	8 / 6	14	42.4	25.0
106908	339.014-6	G 1/4	6 / 4	17	51.4	26.5
106909	339.014-8	G 1/4	8 / 6	17	51.4	27.5
106910	339.014-10	G 1/4	10 / 8	17	51.4	28.5

Unidirectional flow control valve, supply air throttle (V), plug-in connector, rotating

Art. No.	Type No.	Thread	For hose mm	a/f mm	B mm	C mm
113728 NEW	341.005-4-D	M5	4	6	39.4	18.5
113730 NEW	341.005-6-D	M5	6	6	39.4	21.5
113739 NEW	341.018-4-D	G 1/8	4	9	41.9	20.5
113741 NEW	341.018-6-D	G 1/8	6	9	41.9	22.5
113743 NEW	341.018-8-D	G 1/8	8	9	41.9	23.5
113790 NEW	341.014-6-D	G 1/4	6	10	50.8	24.0
113809 NEW	341.014-8-D	G 1/4	8	10	50.8	24.5
114526 NEW	341.014-10-D	G 1/4	10	10	50.8	27.0
115700 NEW	341.038-8-D	G 3/8	8	14	63.5	26.5
115701 NEW	341.038-10-D	G 3/8	10	14	63.5	29.0

Unidirectional flow control valves

adjustable with slotted-head screwdriver

PLUS

For throttling flow rates and regulating the piston speed of cylinders. Small dimensions, ideal for tight spaces. To be screwed directly into the valve or cylinder. The set flow rate can be locked via the lock nut in the version with knurled screw. The variants in banjo bolt construction can be rotated during assembly and are fixed after tightening. The variants with plug-in connector, rotated can also be rotated freely after assembly. The seals and lubricants used are silicone-free.

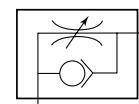

Operating pressure	0 - 10 bar
Temperature range	-20 to 80 °C
Body	Nickel-plated brass
Sealant	NBR
Captive seals	Polyamide, glass fibre-reinforced (only parts in banjo bolt construction)

Unidirectional flow control valve, discharge throttle (C), screw connection, banjo bolt construction

Art. No.	Type No.	Thread	Connection	a/f mm	B mm	C mm
106919	358.005-M5	M5	M5 female thread	8	24.5	11.5
106920	358.018-1/8	G 1/8	G 1/8 female thread	14	32.0	16.0
106921	358.014-1/4	G 1/4	G 1/4 female thread	17	40.0	22.0
106922	358.038-3/8	G 3/8	G 3/8 female thread	20	50.0	26.0
106923	358.012-1/2	G 1/2	G 1/2 female thread	26	61.0	32.0

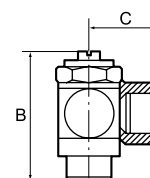

358.005-M5

Unidirectional flow control valve, discharge throttle (C), quick-lock screw fitting, banjo bolt construction

Art. No.	Type No.	Thread	For hose mm	a/f mm	B mm	C mm
106924	358.005-4	M5	4 / 2.5	8	24.5	18.0
106925	358.005-5	M5	5 / 3	8	24.5	19.0
106926	358.005-6	M5	6 / 4	8	24.5	19.0
106927	358.018-5	G 1/8	5 / 3	14	32.0	23.0
106928	358.018-6	G 1/8	6 / 4	14	32.0	25.0
106929	358.018-8	G 1/8	8 / 6	14	32.0	25.0
106930	358.014-6	G 1/4	6 / 4	17	40.0	26.5
106931	358.014-8	G 1/4	8 / 6	17	40.0	27.5
106932	358.014-10	G 1/4	10 / 8	17	40.0	28.5
106933	358.038-10	G 3/8	10 / 8	20	50.0	30.5

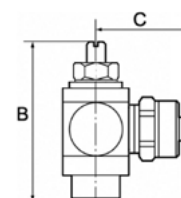

358.014-6

Unidirectional flow control valve, discharge throttle (C), plug-in connector, rotating

Art. No.	Type No.	Thread	For hose mm	a/f mm	B mm	C mm
115702 NEW	343.005-4-D	M5	4	6	25.5	18.5
115703 NEW	343.005-6-D	M5	6	6	25.5	21.5
115704 NEW	343.018-4-D	G 1/8	4	9	31.8	20.5
115705 NEW	343.018-6-D	G 1/8	6	9	31.8	22.5
115706 NEW	343.018-8-D	G 1/8	8	9	31.8	23.5
115809 NEW	343.014-6-D	G 1/4	6	10	39.5	24.0
116338 NEW	343.014-8-D	G 1/4	8	10	39.5	24.5
116339 NEW	343.014-10-D	G 1/4	10	10	39.5	27.0
116500 NEW	343.038-8-D	G 3/8	8	14	50.0	26.5
116502 NEW	343.038-10-D	G 3/8	10	14	50.0	29.0

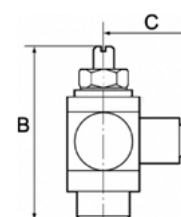

343.018-6-D

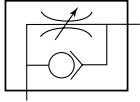

Unidirectional flow control valves

adjustable with knurled screw

PLUS

For throttling flow rates and regulating the piston speed of cylinders. Small dimensions, ideal for tight spaces. To be screwed directly into the valve or cylinder. The set flow rate can be locked via the lock nut in the version with knurled screw. The variants in banjo bolt construction can be rotated during assembly and are fixed after tightening. The variants with plug-in connector, rotated can also be rotated freely after assembly. The seals and lubricants used are silicone-free.

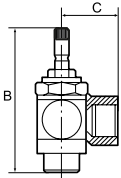

333.014-1/4

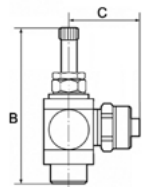

333.005-6

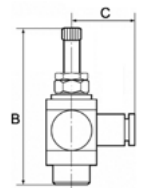

340.018-6-D

Operating pressure	0 - 10 bar
Temperature range	-20 to 80 °C
Body	Nickel-plated brass
Sealant	NBR
Captive seals	Polyamide, glass fibre-reinforced (only parts in banjo bolt construction)

Unidirectional flow control valve, discharge throttle (C), screw connection, banjo bolt construction

Art. No.	Type No.	Thread	Connection	a/f mm	B mm	C mm
106943	333.005-M5	M5	M5 female thread	8	38.9	11.5
106944	333.018-1/8	G 1/8	G 1/8 female thread	14	42.0	16.0
106945	333.014-1/4	G 1/4	G 1/4 female thread	17	51.0	22.0
106946	333.038-3/8	G 3/8	G 3/8 female thread	20	63.0	26.0
106947	333.012-1/2	G 1/2	G 1/2 female thread	26	81.0	32.0

Unidirectional flow control valve, discharge throttle (C), quick-lock screw fitting, banjo bolt construction

Art. No.	Type No.	Thread	For hose mm	a/f mm	B mm	C mm
106948	333.005-4	M5	4 / 2.5	8	38.9	18.0
106949	333.005-5	M5	5 / 3	8	38.9	19.0
106950	333.005-6	M5	6 / 4	8	38.9	19.0
106951	333.018-6	G 1/8	6 / 4	14	42.4	25.0
106952	333.018-8	G 1/8	8 / 6	14	42.4	25.0
106953	333.014-6	G 1/4	6 / 4	17	51.4	26.5
106954	333.014-8	G 1/4	8 / 6	17	51.4	27.5
106955	333.014-10	G 1/4	10 / 8	17	51.4	28.5

Unidirectional flow control valve, discharge throttle (C), plug-in connector, rotating

Art. No.	Type No.	Thread	For hose mm	a/f mm	B mm	C mm
116739 NEW	340.005-4-D	M5	4	6	39.4	18.5
116744 NEW	340.005-6-D	M5	6	6	39.4	21.5
116799 NEW	340.018-4-D	G 1/8	4	9	41.9	20.5
116807 NEW	340.018-6-D	G 1/8	6	9	41.9	22.5
116810 NEW	340.018-8-D	G 1/8	8	9	41.9	23.5
116820 NEW	340.014-6-D	G 1/4	6	10	50.8	24.0
116831 NEW	340.014-8-D	G 1/4	8	10	50.8	24.5
116832 NEW	340.014-10-D	G 1/4	10	10	50.8	27.0
116833 NEW	340.038-8-D	G 3/8	8	14	63.5	26.5
116834 NEW	340.038-10-D	G 3/8	10	14	63.5	29.0

Bidirectional flow control valves

adjustable with slotted-head screwdriver

PLUS

For throttling flow rates and regulating the piston speed of cylinders. Small dimensions, ideal for tight spaces. To be screwed directly into the valve or cylinder. The set flow rate can be locked via the lock nut in the version with knurled screw. The variants in banjo bolt construction can be rotated during assembly and are fixed after tightening. The variants with plug-in connector, rotated can also be rotated freely after assembly. The seals and lubricants used are silicone-free.

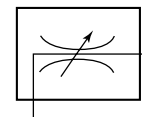

Operating pressure	0 - 10 bar
Temperature range	-20 to 80 °C
Body	Nickel-plated brass
Sealant	NBR
Captive seals	Polyamide, glass fibre-reinforced (only parts in banjo bolt construction)

Bidirectional flow control valve, both directions throttling (B), screw connection, banjo bolt construction

Art. No.	Type No.	Thread	Connection	a/f mm	B mm	C mm
106964	359.005-M5	M5	M5 female thread	8	24.5	11.5
106965	359.018-1/8	G 1/8	G 1/8 female thread	14	32.0	16.0
106966	359.014-1/4	G 1/4	G 1/4 female thread	17	40.0	22.0
106967	359.038-3/8	G 3/8	G 3/8 female thread	20	50.0	26.0
106968	359.012-1/2	G 1/2	G 1/2 female thread	26	61.0	32.0

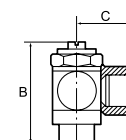

359.005-M5

Bidirectional flow control valve, both directions throttling (B), quick-lock screw fitting, banjo bolt construction

Art. No.	Type No.	Thread	For hose mm	a/f mm	B mm	C mm
106969	359.005-4	M5	4 / 2.5	8	24.5	18.0
106970	359.005-5	M5	5 / 3	8	24.5	19.0
106971	359.005-6	M5	6 / 4	8	24.5	19.0
106972	359.018-5	G 1/8	5 / 3	14	32.0	23.0
106973	359.018-6	G 1/8	6 / 4	14	32.0	25.0
106974	359.018-8	G 1/8	8 / 6	14	32.0	25.0
106975	359.014-6	G 1/4	6 / 4	17	40.0	26.5
106976	359.014-8	G 1/4	8 / 6	17	40.0	27.5
106977	359.014-10	G 1/4	10 / 8	17	40.0	28.5
106978	359.038-10	G 3/8	10 / 8	20	50.0	30.5

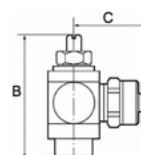

359.014-6

Bidirectional flow control valve, both directions throttling (B), plug-in connector, rotating

Art. No.	Type No.	Thread	For hose mm	a/f mm	B mm	C mm
116835 NEW	344.005-4-D	M5	4	6	25.5	18.5
116836 NEW	344.005-6-D	M5	6	6	25.5	21.5
116844 NEW	344.018-4-D	G 1/8	4	9	31.8	20.5
116845 NEW	344.018-6-D	G 1/8	6	9	31.8	22.5
116846 NEW	344.018-8-D	G 1/8	8	9	31.8	23.5
116847 NEW	344.014-6-D	G 1/4	6	10	39.5	24.0
116848 NEW	344.014-8-D	G 1/4	8	10	39.5	24.5
116872 NEW	344.014-10-D	G 1/4	10	10	39.5	27.0
116924 NEW	344.038-8-D	G 3/8	8	14	50.0	26.5
116942 NEW	344.038-10-D	G 3/8	10	14	50.0	29.0

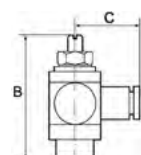

344.018-6-D

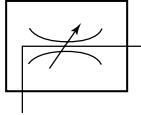

Bidirectional flow control valves

adjustable with knurled screw

PLUS

For throttling flow rates and regulating the piston speed of cylinders. Small dimensions, ideal for tight spaces. To be screwed directly into the valve or cylinder. The set flow rate can be locked via the lock nut in the version with knurled screw. The variants in banjo bolt construction can be rotated during assembly and are fixed after tightening. The variants with plug-in connector, rotated can also be rotated freely after assembly. The seals and lubricants used are silicone-free.

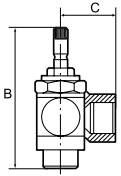

337.018-1/8

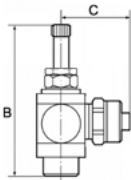

337.014-6

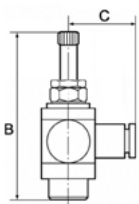

338.018-6-D

Operating pressure	0 - 10 bar
Temperature range	-20 to 80 °C
Body	Nickel-plated brass
Sealant	NBR
Captive seals	Polyamide, glass fibre-reinforced (only parts in banjo bolt construction)

Bidirectional flow control valve, both directions throttling (B), screw connection, banjo bolt construction

Art. No.	Type No.	Thread	Connection	a/f mm	B mm	C mm
106988	337.005-M5	M5	M5 female thread	8	38.9	11.5
106989	337.018-1/8	G 1/8	G 1/8 female thread	14	42.0	16.0
106990	337.014-1/4	G 1/4	G 1/4 female thread	17	51.0	22.0
106991	337.038-3/8	G 3/8	G 3/8 female thread	20	63.0	26.0
106992	337.012-1/2	G 1/2	G 1/2 female thread	26	81.0	32.0

Bidirectional flow control valve, both directions throttling (B), quick-lock screw fitting, banjo bolt construction

Art. No.	Type No.	Thread	For hose mm	a/f mm	B mm	C mm
106993	337.005-4	M5	4 / 2.5	8	38.9	18.0
106994	337.005-5	M5	5 / 3	8	38.9	19.0
106995	337.005-6	M5	6 / 4	8	38.9	19.0
106996	337.018-5	G 1/8	5 / 3	14	42.0	23.0
106997	337.018-6	G 1/8	6 / 4	14	42.0	25.0
106998	337.018-8	G 1/8	8 / 6	14	42.0	25.0
106999	337.014-6	G 1/4	6 / 4	17	51.0	26.5
107000	337.014-8	G 1/4	8 / 6	17	51.0	27.5
107001	337.014-10	G 1/4	10 / 8	17	51.0	28.5

Bidirectional flow control valve, both directions throttling (B), plug-in connector, rotating

Art. No.	Type No.	Thread	For hose mm	a/f mm	B mm	C mm
116953 NEW	338.005-4-D	M5	4	6	39.4	18.5
116954 NEW	338.005-6-D	M5	6	6	39.4	21.5
116955 NEW	338.018-4-D	G 1/8	4	9	41.9	20.5
116956 NEW	338.018-6-D	G 1/8	6	9	41.9	22.5
116957 NEW	338.018-8-D	G 1/8	8	9	41.9	23.5
116958 NEW	338.014-6-D	G 1/4	6	10	50.8	24.0
116959 NEW	338.014-8-D	G 1/4	8	10	50.8	24.5
116960 NEW	338.014-10-D	G 1/4	10	10	50.8	27.0
116961 NEW	338.038-8-D	G 3/8	8	14	63.5	26.5
116962 NEW	338.038-10-D	G 3/8	10	14	63.5	29.0

Toggle valves

Manually operated toggle valve, 2/2-way types. For all applications where compressed air must be switched on or off quickly and easily or a cylinder operated manually. Designed as a banjo-type valve with a hollow bolt and ring piece. Suitable for screwing directly into the equipment or for panel mounting. Compact type of construction, also ideal where space is restricted.

Max. operating pressure	8 bar
Temperature range	-20 to 80 °C
Hollow bolt	Nickel-plated brass
Pivoting arm	Nickel-plated brass
Toggle	Nickel-plated brass
Internal parts	Brass with a bare metal surface
Sealant	NBR
Captive seals	Polyamide (glass fibre-reinforced)
Thread for panel mounting	M12x0.75 (max. plate thickness 4 mm)

2/2-way toggle valves

PLUS

2/2-way toggle valve, discharge port on both sides, screw connection

Art. No.	Type No.	Thread	Connection	For hose mm	a/f mm	B mm	C mm
107009	360.018-1/8	G 1/8	Discharge port on both sides	G 1/8 female thread	14	55.0	16.0
107013	360.014-1/4	G 1/4	Discharge port on both sides	G 1/4 female thread	17	60.0	22.0

2/2-way toggle valve, discharge port on both sides, quick-lock screw fitting

Art. No.	Type No.	Thread	Connection	For hose mm	a/f mm	B mm	C mm
107010	360.018-5	G 1/8	Discharge port on both sides	5/3	14	55.0	25.0
107011	360.018-6	G 1/8	Discharge port on both sides	6/4	14	55.0	25.0
107012	360.018-8	G 1/8	Discharge port on both sides	8/6	14	55.0	25.0
107014	360.014-6	G 1/4	Discharge port on both sides	6/4	17	60.0	26.5
107015	360.014-8	G 1/4	Discharge port on both sides	8/6	17	60.0	27.5
107016	360.014-10	G 1/4	Discharge port on both sides	10/8	17	60.0	28.5

2/2-way toggle valve, discharge port on both sides, plug-in connector

Art. No.	Type No.	Thread	Connection	For hose mm	a/f mm	B mm	C mm
107017	3614.018-4	G 1/8	Discharge port on both sides	4	14	55.0	19.5
107018	3614.018-6	G 1/8	Discharge port on both sides	6	14	55.0	22.0
107019	3614.018-8	G 1/8	Discharge port on both sides	8	14	55.0	22.5
107020	3614.014-6	G 1/4	Discharge port on both sides	6	17	60.0	23.5
107021	3614.014-8	G 1/4	Discharge port on both sides	8	17	60.0	24.0
107022	3614.014-10	G 1/4	Discharge port on both sides	10	17	60.0	26.5

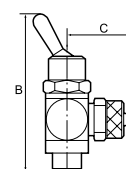
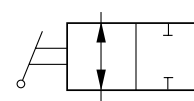

360.018-1/8



360.014-6



3614.014-6

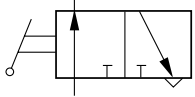

3/2-way toggle valves

PLUS

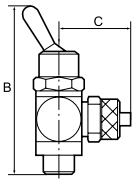

361.018-1/8



361.014-6



3615.014-6



252 M/S

3/2-way toggle valve, pressure port on hose side, screw connection

Art. No.	Type No.	Thread	Connection	For hose mm	a/f mm	B mm	C mm
107023	361.018-1/8	G 1/8	Pressure port on hose side	G 1/8 female thread	14	55.0	16.0
107027	361.014-1/4	G 1/4	Pressure port on hose side	G 1/4 female thread	17	60.0	22.0

3/2-way toggle valve, pressure port on hose side, quick-lock screw fitting

Art. No.	Type No.	Thread	Connection	For hose mm	a/f mm	B mm	C mm
107024	361.018-5	G 1/8	Pressure port on hose side	5/3	14	55.0	25.0
107025	361.018-6	G 1/8	Pressure port on hose side	6/4	14	55.0	25.0
107026	361.018-8	G 1/8	Pressure port on hose side	8/6	14	55.0	25.0
107028	361.014-6	G 1/4	Pressure port on hose side	6/4	17	60.0	26.5
107029	361.014-8	G 1/4	Pressure port on hose side	8/6	17	60.0	27.5
107030	361.014-10	G 1/4	Pressure port on hose side	10/8	17	60.0	28.5

3/2-way toggle valve, pressure port on hose side, plug-in connector

Art. No.	Type No.	Thread	Connection	For hose mm	a/f mm	B mm	C mm
107031	3615.018-4	G 1/8	Pressure port on hose side	4	14	55.0	19.5
107032	3615.018-6	G 1/8	Pressure port on hose side	6	14	55.0	22.0
107033	3615.018-8	G 1/8	Pressure port on hose side	8	14	55.0	22.5
107034	3615.014-6	G 1/4	Pressure port on hose side	6	17	60.0	23.5
107035	3615.014-8	G 1/4	Pressure port on hose side	8	17	60.0	24.0
107036	3615.014-10	G 1/4	Pressure port on hose side	10	17	60.0	26.5

Accessories

Art. No.	Type No.	Description
107037	252 M/S	Hexagon lock nut / M12x0.75 / nickel-plated brass

Mini pressure regulators

PLUS

Piston pressure regulator with self-relieving design, hollow bolt and pivoting ring piece. The regulator is connected directly into the consumer (e.g. cylinder, handling equipment, etc.). The working pressure can thus be adapted to the specific application.

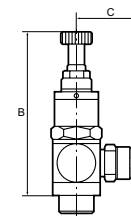
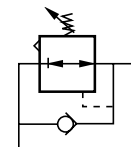

Control range	0 - 8 bar
Max. input pressure	10 bar
Temperature range	0 to 70 °C
Hollow bolt	Nickel-plated brass
Pivoting arm	Nickel-plated brass
Adjusting screw	Nickel-plated brass
Internal parts	Brass with a bare metal surface
Sealant	NBR
Captive seals	Polyamide (glass fibre-reinforced)

Mini pressure regulators, discharge port on thread, screw connection

Art. No.	Type No.	Thread	Connection	a/f mm	B mm	C mm
107038	362.018-1/8	G 1/8	G 1/8 female thread	15	56.0	16.0



362.018-1/8

Mini pressure regulator, discharge port on thread, quick-lock screw fitting

Art. No.	Type No.	Thread	For hose mm	a/f mm	B mm	C mm
107039	362.018-5	G 1/8	5 / 3	15	56.0	25.0
107040	362.018-6	G 1/8	6 / 4	15	56.0	25.0
107041	362.018-8	G 1/8	8 / 6	15	56.0	25.0
107042	362.014-6	G 1/4	6 / 4	17	63.0	26.5
107043	362.014-8	G 1/4	8 / 6	17	63.0	27.5
107044	362.014-10	G 1/4	10 / 8	17	63.0	28.5



362.014-6

Mini pressure regulator, discharge port on thread, plug-in connector

Art. No.	Type No.	Thread	For hose mm	a/f mm	B mm	C mm
107045	3621.018-4	G 1/8	4	15	56.0	19.5
107046	3621.018-6	G 1/8	6	15	56.0	22.0
107047	3621.018-8	G 1/8	8	15	56.0	22.5
107048	3621.014-6	G 1/4	6	17	63.0	23.5
107049	3621.014-8	G 1/4	8	17	63.0	24.0
107050	3621.014-10	G 1/4	10	17	63.0	26.5



3621.014-6



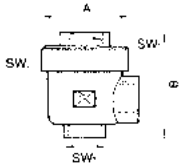

Quick-exhaust valves

PLUS

Housing	Nickel-plated brass
Diaphragms	Polyurethane
Operating pressure	0.5 - 12 bar
Operating temperature	-20 to 80 °C
Standard thread	G thread acc. DIN EN ISO 228-1



500.12



501.12

Quick-exhaust valve

Art. No.	Type No.	Thread	a/f 1 mm	a/f 2 mm	a/f 3 mm	A mm	B mm
107051	500.18	G 1/8	14	14	14	28.0	42.0
107052	500.14	G 1/4	19	19	19	33.0	53.0
107053	500.12	G 1/2	26	26	26	43.0	71.0

Replacement diaphragm

Art. No.	Type No.	Description
107054	501.18	For G 1/8 exhaust valve
107055	501.14	For G 1/4 exhaust valve
107056	501.12	For G 1/2 exhaust valve

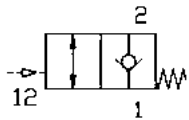

Pneumatically piloted stop valves

PLUS

For stopping and positioning the cylinder movement:
 If a control signal is present at port 3 (see drawing), air can flow to and from the cylinder.
 If no control signal is present, the cylinder exhaust air is shut off by the unidirectional valve. The cylinder is stopped. Releasable unidirectional valves are screwed directly onto the cylinder instead of the normal pipe connections.
 Note: Pilot pressure is depending on operating pressure.

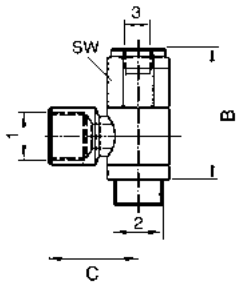

Operating pressure	0.3 - 10 bar
Pilot pressure	0.5 - 2.5 bar
Max. medium temperature	60 °C
Max. ambient temperature	60 °C
Material	Nickel-plated brass
Sealant	NBR
Mounting position	Any, ring piece must be pos. before tightening the valve



63.014-14

Pneumatically piloted stop valve, port 2 with female thread

Art. No.	Type No.	Port 1	Port 2	Port 3	B mm	C mm
107057	63.018-18	G 1/8	G 1/8	M5	38.0	21.5
107058	63.014-14	G 1/4	G 1/4	G 1/8	43.0	25.4
107059	63.038-38	G 3/8	G 3/8	G 1/8	46.0	31.6
107060	63.012-12	G 1/2	G 1/2	G 1/8	52.0	32.0

Stop valves pneumatically operated

PLUS

For high-speed positioning and stop functions as well as emergency switching (e.g. emergency stop). If a control signal is present at port 3, air can flow to and from the cylinder. If no control signal is present, the air flow to and from the cylinder is shut off, causing the cylinder to stop in the required position. Stop valves are screwed directly onto the cylinder instead of the normal pipe connections.
 Note: Pilot pressure is depending on operating pressure.

Max. operating pressure	10 bar
Pilot pressure	1 - 5 bar
Max. medium temperature	70 °C
Max. ambient temperature	70 °C
Material	Nickel-plated brass
Sealant	NBR
Mounting position	Any, ring piece can be rotated 360° after tighten. the valve

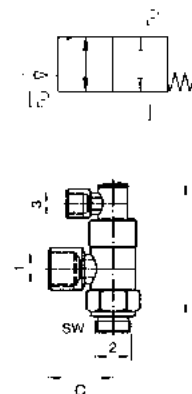

Stop valve, ports 2 and 3 with female thread

Art. No.	Type No.	Port 1	Port 2	Port 3	B mm	C mm
107061	66.018-18	G 1/8	G 1/8	G 1/8	52.0	21.0
107062	66.014-14	G 1/4	G 1/4	G 1/8	58.0	25.0
107063	66.038-38	G 3/8	G 3/8	G 1/8	63.0	31.0
107064	66.012-12	G 1/2	G 1/2	G 1/8	72.0	40.0



66.018-18

Stop valve, ports 2 and 3 with plug connection

Art. No.	Type No.	Port 1	Port 2	Port 3	B mm	C mm
107065	67.018-6	G 1/8	6 mm	4 mm	52.0	25.0
107066	67.014-6	G 1/4	6 mm	4 mm	58.0	28.0
107067	67.038-8	G 3/8	8 mm	4 mm	63.0	32.0
107068	67.012-12	G 1/2	12 mm	4 mm	72.0	41.0



67.018-6



5 HOSE COUPLINGS



SAFE.

FASTER.

COUPELED.

**One-hand quick disconnect couplings,
one side sealing DN 2.7**

Quick disconnect couplings
DN 2.7, brass with a bare
metal surface, »R20MS« series
Page 472



Stems and plugs, brass
with a bare metal surface
Page 472-473



Quick disconnect couplings
DN 2.7, nickel-plated brass,
»R20MSV« series
Page 473-474



Stems and plugs,
nickel-plated brass
Page 474-475



Quick disconnect couplings
DN 2.7, stainless steel 1.4305,
»R20ESE« series
Page 475-476



Stems and plugs,
stainless steel 1.4305
Page 476

**One-hand quick disconnect couplings,
one side sealing DN 5**

Quick disconnect couplings
DN 5, brass with a bare metal
surface, »R21EMS« series
Page 477



Stems and plugs, brass with
a bare metal surface
Page 478



Quick disconnect couplings
DN 5, nickel-plated brass,
»R21EMSV« series
Page 479



Stems and plugs,
nickel-plated brass
Page 480

**One-hand quick disconnect couplings,
one side sealing DN 5**

Quick disconnect couplings
DN 5, brass with a bare metal
surface, »R21MS« series
Page 481-482



Quick disconnect couplings
DN 5, nickel-plated brass,
»R21MSV« series
Page 482-483



Quick disconnect couplings
DN 5, stainless steel 1.4305,
»R21ES« series
Page 483-484



Stems and plugs,
stainless steel 1.4305
Page 484

**One-hand quick disconnect couplings,
one side sealing DN 7.2**

Quick disconnect couplings
DN 7.2, brass with a bare metal
surface, »R26EMS« series
Page 485



Distributors
Page 486, 493-494



Stems and plugs, brass
with a bare metal surface
Page 486-487



Assortment box
Page 488, 496



Quick disconnect couplings
DN 7.2, nickel-plated brass,
»R26EMSV« series
Page 489



Stems and plugs,
nickel-plated brass
Page 490-491

**One-hand quick disconnect couplings,
one side sealing DN 7.2**

Plugs and hose stems, swivel
type, nickel-plated brass
Page 491



Quick disconnect couplings
DN 7.2, brass with a bare
metal surface, »R26MS« series
Page 492-493



Porting boxes,
»R26MS« series
Page 495



Quick disconnect couplings
DN 7.2, nickel-plated brass,
»R26MSV« series
Page 497-498



Quick disconnect couplings
DN 7.2, stainless steel 1.4305,
»R26ES« series
Page 498-499



Stems and plugs,
stainless steel 1.4305
Page 499

**One-hand quick disconnect couplings,
one side sealing DN 7.8**

Quick disconnect couplings
DN 7.8, galvanised steel,
»R25ST« series
Page 500-501



Stems and plugs,
galvanised steel
Page 501-502



Quick disconnect couplings
DN 7.8, nickel-plated brass /
plastic, »R16K« series
Page 502-503



Stems and plugs,
nickel-plated brass
Page 503-504



One-hand quick disconnect couplings, one side sealing DN 7.8



Quick disconnect couplings DN 7.8, stainless steel 1.4305, »R25ES« series
Page 504-505



Stems and plugs, stainless steel 1.4305
Page 505

Compressed air distributor system Type »Multi-Link«



Compressed air distributor system Type »Multi-Link«
Page 506

One-hand quick disconnect couplings, one side sealing DN 10



Quick disconnect couplings DN 10, steel / nickel-plated brass, »R27MSV« series
Page 507



Stems and plugs, hardened and nickel-plated steel
Page 508



Quick disconnect couplings DN 10, steel / nickel-plated brass, »R27EMSV« series
Page 509

One-hand quick disconnect couplings, one side sealing DN 12



Quick disconnect couplings DN 12, brass with a bare metal surface, »R12MS« series
Page 510



Stems and plugs, brass with a bare metal surface
Page 510-511

One-hand quick disconnect couplings, one side sealing DN 19



Quick disconnect couplings DN 19, brass with a bare metal surface, »R39MS« series
Page 512



Stems and plugs, brass with a bare metal surface
Page 512-513

One-hand quick disconnect couplings, both side sealing



Quick disconnect couplings DN 5, brass with a bare metal surface, »R21BA« series
Page 514



Stems and plugs DN 5, brass with a bare metal surface
Page 514-515



Quick disconnect couplings DN 7.2, brass with a bare metal surface, »R26BA« series
Page 515-516



Stems and plugs DN 7.2 to DN 7.8, brass with a bare metal surface
Page 516

Safety couplings DN 7.4



Safety couplings DN 7.4, »R26K« series
Page 517



Stems and plugs, hardened and galvanised steel
Page 518

Safety couplings DN 7.6



Safety couplings DN 7.6, »R320ST« series
Page 519

Safety couplings DN 7.6



Stems and plugs, hardened and galvanised steel
Page 520

Safety couplings DN 7.8



Safety couplings DN 7.8
Page 521



Stems and plugs, hardened and galvanised steel
Page 521-522



Safety couplings DN 7.8, »R125MSV« series
Page 522-523



Stems and plugs, nickel-plated brass
Page 523-524

Safety couplings DN 10



Safety couplings DN 10, »R410ST« series
Page 525



Stems and plugs, hardened and galvanised steel
Page 526

Safety couplings, pushbutton type



Pushbutton safety couplings DN 5.5, acc. ARO 210, »R244AAL« series
Page 527



Stems and plugs, ARO 210, hardened and galvanised steel
Page 527-528

Safety couplings, pushbutton type



Pushbutton safety couplings
DN 6, acc. ISO 6150 C,
»R107S.06« series
Page 528-529



Stems and plugs DN 6,
ISO 6150 C, stainless steel
Page 529



Pushbutton safety couplings
DN 7.4, »DKSK« series
Page 530



Stems and plugs, hardened
and galvanised steel
Page 531



Porting boxes
Page 532



Pushbutton safety couplings
DN 7.4, stainless steel 1.4404,
»R244ES« series
Page 533



Stems and plugs,
stainless steel 1.4305
Page 534



Pushbutton safety couplings
DN 8, acc. ISO 6150 C,
»R107S.08« series
Page 535



Stems and plugs DN 8,
ISO 6150 C, stainless steel
Page 536



Pushbutton safety couplings
DN 11, acc. ISO 6150 C,
»R107S.11« series
Page 537



Stems and plugs DN 11,
ISO 6150 C, stainless steel
Page 538

Safety couplings, swivel type



Swivel safety couplings DN 6,
acc. ISO 6150 C,
»R-SV1« series
Page 539



Stems and plugs DN 6,
ISO 6150 C, steel,
QPQ treated
Page 540



Swivel safety couplings DN 8,
acc. ISO 6150 C,
»R-SV2« series
Page 541



Stems and plugs DN 8,
ISO 6150 C, steel,
QPQ treated
Page 542



Stems and plugs DN 8,
ISO 6150 C, hardened,
galvanised steel, steel,
QPQ treated
Page 542-543

Safety couplings, swing type



Swing safety couplings
DN 7.2, »R-SC/C« series
Page 544



Stems and plugs DN 7.2,
hardened and galvanised
steel
Page 545



Porting boxes, »R-SC/C« series
Page 546

Non-interchangeable couplings



Quick disconnect couplings
DN 5, »R21UV« series
Page 547



Stems and plugs DN 5
Page 548

Non-interchangeable couplings



Quick disconnect couplings
DN 7.8, »R26UV« series
Page 549



Stems and plugs DN 7.8
Page 550

Hydraulic couplings, both sides sealing



Brass with a bare metal
surface
Page 551



Plastic POM (Delrin)
Page 552



acc. to ISO 7241-1, A Series
Page 553-554



acc. to ISO 7241-1, B Series
Page 555-556



Stainless steel 1.4305
Page 557

GEKA couplings



Brass with a bare metal
surface
Page 558-559



for drinking water, brass
with a bare metal surface
Page 560



Stainless steel
Page 561



Claw couplings (compressor couplings)



Standard type acc. to
DIN 3489
Page 562-563



Safety type acc. to
DIN 3238
Page 564



Accessories
Page 565

Temperature control couplings



Brass, plug size 9 mm
Page 566-567



Brass, plug size 13 mm
Page 568-569



Accessories
Page 570

KAMLOK hose couplings



Aluminium
Page 571-572



Stainless steel 1.4401
Page 573-575

Storz couplings



Aluminium
Page 576-578

Storz couplings



Stainless steel V4A
Page 579-581

Notes

A large grid of small dots for taking notes, covering most of the page.



DN	RIEGLER series designation	Comparable with	From page	Material					Technical properties		
				Brass / nickel-plated brass	Aluminium	Steel	Stainless steel	max. operating pressure [bar]	Temperature range [°C]	Flow in l/min at 6 bar and $\Delta p = 0.5$ bar	
Plug profile: EURO											
2.7	R20MS / R20MSV	Aventics CP1-NW 2,7 / EWO 310 / FESTO KD2 / Landefeld KDG NW 2,7 / Lüdecke ESMC /	472	•				35	-20 to 100	165	
	R20ESE	Parker 20 / Walther 06-003	475				•	35	-20 to 200	120	
5	R21MS / R21MSV	FESTO KD3 / Landefeld KDG NW 5.0 / Lüdecke ESM / Rectus 21, 90	481	•				35	-20 to 100	560	
	R21EMS / R21EMSV		477	•				35	-20 to 100	560	
	R21ES		483				•	35	-15 to 200	560	
	R21BA		514	•				35	-20 to 100	310	
	R21UV		547	•				35	-20 to 100	560	
7.2-7.8	R26MS / R26MSV	Atlas Copco ERGOQIC08E, QIC10E, QIC10SE / Camozzi 5080-5180 / Cejn 320 / FESTO KDS6, KD4 / JWL 520, 530 / Landefeld KDG NW 7.2, KDGC NW7, KDGSIP NW7 / Lüdecke ESPN, ESIS, ES, ESI / Prevost ESI07 / Rectus 25, 26, 1600, 1625 / RTC 463, 025	492	•				35	-20 to 100	1000	
	R26EMS / R26EMSV		485	•				35	-20 to 100	1000	
	R26ES		498				•	35	-25 to 200	1000	
	R26BA		515	•				35	-20 to 100	700	
	R26UV		549	•				35	-20 to 100	1800	
	R16K		502	•				35	-20 to 40	2100	
	R25ST		500			•		35	-20 to 100	2000	
	R25ES		504				•	35	-15 to 200	1800	
	R26K		517	•				12	-20 to 60	1300	
	DKSK		530		•			12	-20 to 70	1600*	
	R244ES		533				•	12	-20 to 150	1600*	
	R-SC/C		544			•		25	-20 to 100	2300	
	R320ST		519			•		16	-20 to 100	2250	
R125MSV	522	•				20	-20 to 100	2050			
10	R27MSV	Atlas Copco ERGOQIC15E, QIC15E, QIC15SE / Cejn 410 / Landefeld KDG NW10 / Lüdecke ESIG / Rectus 27 / RTC 027	507	•				35	-20 to 100	3600	
	R27EMSV		509	•				35	-20 to 100	3500	
	R410ST		525			•		16	-20 to 100	4000	
12	R12MS	EWO 254 / Landefeld KDG NW12	510	•				16	-10 to 50	4150	
19	R39MS	Landefeld KDG NW19 / Lüdecke ESG / Rectus 39	512	•				35	-20 to 100	8700	

* at 6 bar and $\Delta p = 1.0$ bar

Technical properties				Media						Design					
Free passage	Locking on one side	Locking on both sides	Seal	Compressed air	Liquids	non-toxic and non-aggressive gases	Chemicals – Test required in individual cases	Aggressive media – Test required in individual cases	Liquid gas	Slide coupling	Push button coupling	Swivelling coupling	Rotating coupling	Asymmetrical coupling	Safety coupling
	•		NBR	•	•	•				•					
	•		FKM	•	•	•				•					
	•		NBR	•	•	•				•					
	•		NBR	•	•	•				•					
	•		FKM	•	•	•	•	•		•					
		•	NBR	•	•	•			•	•					
	•		NBR	•	•	•				•				•	
	•		NBR	•	•	•				•					
	•		NBR	•	•	•				•					
	•		FKM	•	•	•	•	•		•					
		•	NBR	•	•	•			•	•					
	•		NBR	•	•	•				•				•	
	•		NBR	•	•	•				•					
	•		NBR	•	•	•				•					
	•		FKM	•	•	•	•	•		•					
	•		NBR	•		•				•					•
	•		NBR	•		•					•				•
	•		FKM	•		•	•	•			•				•
•			NBR	•		•						•			•
	•		NBR	•		•				•					•
	•		NBR	•		•				•					•
	•		NBR	•	•	•				•					
	•		NBR	•	•	•				•					
	•		NBR	•		•				•					•
	•		NBR	•	•	•				•					
	•		NBR	•	•	•				•					



DN	RIEGLER series designation	Compatible with	From page	Material					Technical properties		
				Brass / nickel-plated brass	Aluminium	Steel	Stainless steel	max. operating pressure [bar]	Temperature range [°C]	Flow in l/min at 6 bar and $\Delta p = 0,5$ bar	
Plug profile: ISO 6150 C											
6	R-SV1	Prevost CSI06 / Rectus 18, 14KE / RTC 461.06, 17106 / Stäubli RCS06, RSI06	539			•		25	-20 to 100	630	
	R107S.06		528				•	12	-20 to 200	1150*	
8	R-SV2	Prevost CSI08 / Rectus 84 / RTC 461.08, 171.08 / Stäubli RCS08, RSI08	541			•		25	-20 to 100	1200	
	R107S.08		535				•	16	-20 to 200	2080*	
11	R107S.11	Prevost ISG11, CSM / RTC 461.11 7 / Stäubli RCS11, RSI11	537				•	16	-20 to 200	4500*	
Plug profile: ARO 210											
5.5	R244AAL	Cejn 300 / EWO 312 / Hansen 210 / JWL 522, 532 / Lüdecke ESO, ESOI / Prevost ASI06 / Rectus 14, 22 / RTC 462, 171.11	527		•			12	-20 to 70	1080*	

* at 6 bar and $\Delta p = 1.0$ bar

Technical properties				Media						Design					
Free passage	Locking on one side	Locking on both sides	Seal	Compressed air	Liquids	non-toxic and non-aggressive gases	Chemicals – Test required in individual cases	Aggressive media – Test required in individual cases	Liquid gas	Slide coupling	Push button coupling	Swivelling coupling	Rotating coupling	Asymmetrical coupling	Safety coupling
	•		NBR	•		•							•		•
	•		FKM	•		•	•	•			•				•
	•		NBR	•		•							•		•
	•		FKM	•		•	•	•			•				•
	•		FKM	•		•	•	•			•				•
	•		NBR	•		•					•				•





Quick disconnect couplings DN 2.7

»R20MS« series

EASY

One-hand quick disconnect couplings, one side sealing, extremely compact with a large bore and only a small pressure drop.

To prevent injuries or a "whiplash" effect, we recommend that the plug-in nipple is held with one hand during uncoupling.

Areas of application: Pneumatic system, machine and plant engineering, measurement, monitoring and control systems, manufacturing industry, medical technology, chemical / pharmaceutical industry, automotive.

Operating pressure	0 to 35 bar, maximum static working pressure (non-pulsating)
Medium temperature	-20 to 100 °C
Ambient temperature	-20 to 100 °C
Flow rate	165 l/min (air)
Flow rate measurement	at 6 bar and $\Delta p = 0.5$ bar
Housing	Brass with a bare metal surface
Sleeve	Brass with a bare metal surface
Valve body	Brass with a bare metal surface
Spring	Stainless steel
Retaining ring	Stainless steel
Ball	Stainless steel
Sealant	NBR



243.08/2

Quick disconnect coupling DN 2.7, brass with a bare metal surface, male

Art. No.	Type No.	Connection	Length mm	a/f mm
107069	243.08/1	M5 ET	26.0	9
107070	243.08/2	G 1/8 ET	28.0	11



243.08/4

Quick disconnect coupling DN 2.7, brass with a bare metal surface, female

Art. No.	Type No.	Connection	Length mm	a/f mm
107071	243.08/3	M5 IT	25.0	9
107072	243.08/4	G 1/8 IT	28.0	12



243.08/6

Quick disconnect coupling DN 2.7, brass with a bare metal surface, with hose stem

Art. No.	Type No.	Connection	Length mm
107073	243.08/5	I.D. 3	35.0
107074	243.08/6	I.D. 4	35.0



243.08/8

Quick disconnect coupling DN 2.7, brass with a bare metal surface, with hose connector

Art. No.	Type No.	Connection	Length mm
107075	243.08/7	Hose connection 4x3	34.0
107076	243.08/8	Hose connection 5x3	34.0
107077	243.08/9	Hose connection 6x4	34.0

Stems for couplings DN 2.7

brass with a bare metal surface



243.09/2

Stem for couplings DN 2.7, brass with a bare metal surface

Art. No.	Type No.	Connection	Length mm
107078	243.09/1	I.D. 3	24.0
107079	243.09/2	I.D. 4	24.0

Plugs for couplings DN 2.7

brass with a bare metal surface

Plug for couplings DN 2.7, brass with a bare metal surface, for hose

Art. No.	Type No.	Connection	Length mm	a/f mm
107080	243.09/3	for hose 4x3	25.0	7
107081	243.09/4	for hose 5x3	25.0	7
107082	243.09/5	for hose 6x4	25.0	8



243.09/5

Plug for couplings DN 2.7, brass with a bare metal surface, male

Art. No.	Type No.	Connection	Length mm	a/f mm
107083	243.09/6	M5 ET	18.0	7
107084	243.09/7	G 1/8 ET	20.0	11



243.09/7

Plug for couplings DN 2.7, brass with a bare metal surface, female

Art. No.	Type No.	Connection	Length mm	a/f mm
107085	243.09/8	M5 IT	17.0	7
107086	243.09/9	G 1/8 IT	19.0	12



243.09/9

Quick disconnect couplings DN 2.7

»R20MSV« series

EASY

One-hand quick disconnect couplings, one side sealing, extremely compact with a large bore and only a small pressure drop.

To prevent injuries or a "whiplash" effect, we recommend that the plug-in nipple is held with one hand during uncoupling.

Areas of application: Pneumatic system, machine and plant engineering, measurement, monitoring and control systems, manufacturing industry, medical technology, chemical / pharmaceutical industry, automotive.



one side sealing

Operating pressure	0 to 35 bar, maximum static working pressure (non-pulsating)
Medium temperature	-20 to 100 °C
Ambient temperature	-20 to 100 °C
Flow rate	165 l/min (air)
Flow rate measurement	at 6 bar and $\Delta p = 0.5$ bar
Housing	Nickel-plated brass
Sleeve	Nickel-plated brass
Valve body	Nickel-plated brass
Spring	Stainless steel
Retaining ring	Stainless steel
Ball	Stainless steel
Sealant	NBR



Quick disconnect coupling DN 2.7, nickel-plated brass, male

Art. No.	Type No.	Connection	Length mm	a/f mm
107087	243.08/1-N	M5 ET	26.0	9
107088	243.08/2-N	G 1/8 ET	28.0	11



243.08/2-N

Quick disconnect coupling DN 2.7, nickel-plated brass, female

Art. No.	Type No.	Connection	Length mm	a/f mm
107089	243.08/3-N	M5 IT	25.0	9
107090	243.08/4-N	G 1/8 IT	28.0	12



243.08/4-N



Quick disconnect couplings DN 2.7

»R20MSV« series

EASY



243.08/6-N

Quick disconnect coupling DN 2.7, nickel-plated brass, with hose stem

Art. No.	Type No.	Connection	Length mm
107091	243.08/5-N	I.D. 3	35.0
107092	243.08/6-N	I.D. 4	35.0



243.08/8-N

Quick disconnect coupling DN 2.7, nickel-plated brass, with hose connector

Art. No.	Type No.	Connection	Length mm
107093	243.08/7-N	Hose connection 4x3	34.0
107094	243.08/8-N	Hose connection 5x3	34.0
107095	243.08/9-N	Hose connection 6x4	34.0



243.08/10-N

Quick disconnect coupling DN 2.7, nickel-plated brass, with push-in fitting

Art. No.	Type No.	Connection	Length mm	a/f mm
107096	243.08/10-N	4 mm	35.0	10

Stems for couplings DN 2.7

nickel-plated brass



243.09/2-N

Stem for couplings DN 2.7, nickel-plated brass

Art. No.	Type No.	Connection	Length mm
107097	243.09/1-N	I.D. 3	24.0
107098	243.09/2-N	I.D. 4	24.0

Plugs for couplings DN 2.7

nickel-plated brass



243.09/5-N

Plug for couplings DN 2.7, nickel-plated brass, for hose

Art. No.	Type No.	Connection	Length mm	a/f mm
107099	243.09/3-N	for hose 4x3	25.0	7
107100	243.09/4-N	for hose 5x3	25.0	7
107101	243.09/5-N	for hose 6x4	25.0	8



243.09/6-N

Plug for couplings DN 2.7, nickel-plated brass, male

Art. No.	Type No.	Connection	Length mm	a/f mm
107102	243.09/6-N	M5 ET	18.0	7
107103	243.09/7-N	G 1/8 ET	20.0	11

Plugs for couplings DN 2.7

nickel-plated brass

Plug for couplings DN 2.7, nickel-plated brass, female

Art. No.	Type No.	Connection	Length mm	a/f mm
107104	243.09/8-N	M5 IT	17.0	7
107105	243.09/9-N	G 1/8 IT	19.0	12



243.09/8-N



243.09/10-N

Push-in plug for couplings DN 2.7, nickel-plated brass

Art. No.	Type No.	Connection	Length mm	a/f mm
107106	243.09/10-N	push-in, 4 mm	25.0	10

Quick disconnect couplings DN 2.7

»R20ESE« series

One-hand quick disconnect couplings, one side sealing, extremely compact with a large bore and only a small pressure drop.

To prevent injuries or a "whiplash" effect, we recommend that the plug-in nipple is held with one hand during uncoupling.

Areas of application: Pneumatic system, machine and plant engineering, measurement, monitoring and control systems, manufacturing industry, medical technology, chemical / pharmaceutical industry, automotive, food technology, offshore.



one side
sealing

Operating pressure	0 to 35 bar, maximum static working pressure (non-pulsating)
Medium temperature	-20 to 200 °C
Ambient temperature	-20 to 200 °C
Flow rate	120 l/min (air)
Flow rate measurement	at 6 bar and $\Delta p = 1$ bar
Housing	Stainless steel 1.4305
Sleeve	Stainless steel 1.4305
Valve body	Stainless steel 1.4305
Spring	Stainless steel 1.4310
Retaining ring	Stainless steel 1.4310
Ball	Stainless steel 1.4034
Sealant	FPM

Quick disconnect coupling DN 2.7, stainless steel 1.4305, male

Art. No.	Type No.	Connection	Length mm	a/f mm
156204	243.08/1-ES-E	M5 ET	26.0	9
156205	243.08/2-ES-E	G 1/8 ET	28.0	11



243.08/2-ES-E

Quick disconnect coupling DN 2.7, stainless steel 1.4305, female

Art. No.	Type No.	Connection	Length mm	a/f mm
156206	243.08/3-ES-E	M5 IT	26.0	9
156207	243.08/4-ES-E	G 1/8 IT	28.0	12



243.08/4-ES-E

Quick disconnect coupling DN 2.7, stainless steel 1.4305, with hose stem

Art. No.	Type No.	Connection	Length mm
156208	243.08/5-ES-E	I.D. 3	34.0
156209	243.08/6-ES-E	I.D. 4	34.0



243.08/6-ES-E





Quick disconnect couplings DN 2.7

»R20ESE« series



243.08/8-ES-E

Quick disconnect coupling DN 2.7, stainless steel 1.4305, with hose connector

Art. No.	Type No.	Connection	Length mm	a/f mm
156210	243.08/7-ES-E	Hose connection 4x3	33.0	9
156211	243.08/8-ES-E	Hose connection 5x3	33.0	9
156212	243.08/9-ES-E	Hose connection 6x4	33.0	9

Stems for couplings DN 2.7

stainless steel 1.4305



243.09/2-ES-E

Stem for couplings DN 2.7, stainless steel 1.4305

Art. No.	Type No.	Connection	Length mm
156255	243.09/1-ES-E	I.D. 3	24.0
156256	243.09/2-ES-E	I.D. 4	24.0

Plugs for couplings DN 2.7

stainless steel 1.4305



243.09/5-ES-E

Plug for couplings DN 2.7, stainless steel 1.4305, for hose

Art. No.	Type No.	Connection	Length mm	a/f mm
156257	243.09/3-ES-E	for hose 4x3	25.0	9
156258	243.09/4-ES-E	for hose 5x3	25.0	9
156259	243.09/5-ES-E	for hose 6x4	25.0	9



243.09/6-ES-E

Plug for couplings DN 2.7, stainless steel 1.4305, male

Art. No.	Type No.	Connection	Length mm	a/f mm
156260	243.09/6-ES-E	M5 ET	18.0	7
156261	243.09/7-ES-E	G 1/8 ET	20.0	11



243.09/8-ES-E

Plug for couplings DN 2.7, stainless steel 1.4305, female

Art. No.	Type No.	Connection	Length mm	a/f mm
156262	243.09/8-ES-E	M5 IT	17.0	7
156263	243.09/9-ES-E	G 1/8 IT	19.0	12

Quick disconnect couplings DN 5

»R21EMS« series, connect line type

EASY

Low-priced, one-hand quick disconnect couplings, one side sealing, compact with a large bore and only a small pressure drop.

To prevent injuries or a "whiplash" effect, we recommend that the plug-in nipple is held with one hand during uncoupling.

Areas of application: Pneumatic system, measurement, monitoring and control systems, manufacturing industry, medical technology, chemical / pharmaceutical industry, automotive, food technology.



Operating pressure	0 to 35 bar, maximum static working pressure (non-pulsating)
Medium temperature	-20 to 100 °C
Ambient temperature	-20 to 100 °C
Flow rate	560 l/min (air)
Flow rate measurement	at 6 bar and $\Delta p = 0.5$ bar
Housing	Brass with a bare metal surface
Sleeve	Brass with a bare metal surface
Valve body	Brass with a bare metal surface
Spring	Stainless steel
Retaining ring	Stainless steel
Locking pins	Stainless steel
Sealant	NBR

Quick disconnect coupling DN 5, brass with a bare metal surface, male

Art. No.	Type No.	Connection	Length mm	a/f mm
115620	243.18-E	G 1/8 ET	35.9	14
115622	243.19-E	G 1/4 ET	37.4	17
115624	243.19/S-E	G 3/8 ET	37.4	19



243.19-E

Quick disconnect coupling DN 5, brass with a bare metal surface, female

Art. No.	Type No.	Connection	Length mm	a/f mm
115626	243.20-E	G 1/8 IT	35.9	14
115628	243.21-E	G 1/4 IT	37.4	17
115630	243.21/S-E	G 3/8 IT	37.4	19



243.21-E

Quick disconnect coupling DN 5, brass with a bare metal surface, with hose stem

Art. No.	Type No.	Connection	Length mm	a/f mm
115634	243.25-E	I.D. 4	41.9	14
115636	243.26-E	I.D. 6	46.9	14
115638	243.26/S-E	I.D. 9	46.9	14



243.26-E



Quick disconnect coupling DN 5, brass with a bare metal surface, with hose connector

Art. No.	Type No.	Connection	Length mm	a/f mm
115640	243.27-E	Hose connection 6x4	42.4	14
115642	243.28-E	Hose connection 8x6	42.4	14



243.27-E

Stems for couplings DN 5

brass with a bare metal surface



243.16

Stem for couplings DN 5, brass with a bare metal surface

Art. No.	Type No.	Connection	Length mm
107145	243.16	I.D. 4	27.0
107146	243.17	I.D. 6	32.0
107147	243.17/S	I.D. 9	34.0

Plugs for couplings DN 5

brass with a bare metal surface



243.032

Plug for couplings DN 5, brass with a bare metal surface, male

Art. No.	Type No.	Connection	Length mm	a/f mm
107148	243.031	G 1/8 ET	25.0	14
107149	243.032	G 1/4 ET	26.0	17
107150	243.032/S	G 3/8 ET	27.0	19



243.034

Plug for couplings DN 5, brass with a bare metal surface, female

Art. No.	Type No.	Connection	Length mm	a/f mm
107151	243.033	G 1/8 IT	25.0	14
107152	243.034	G 1/4 IT	26.0	17
107153	243.034/S	G 3/8 IT	26.0	19



243.29

Plug for couplings DN 5, brass with a bare metal surface, for hose

Art. No.	Type No.	Connection	Length mm	a/f mm
107154	243.29	for hose 6x4	32.0	12
107155	243.30	for hose 8x6	32.0	14



243.39

Plug for couplings DN 5, brass with a bare metal surface, for hose with swivel nut and kink protector spring

Art. No.	Type No.	Connection	Length mm	a/f mm
107156	243.39	for hose 6x4 with swivel nut and kink protector spring	110.0	12
107157	243.39/1	for hose 8x6 with swivel nut and kink protector spring	120.0	14

Quick disconnect couplings DN 5

»R21EMSV« series, connect line type

EASY

Low-priced, one-hand quick disconnect couplings, one side sealing, compact with a large bore and only a small pressure drop.

To prevent injuries or a "whiplash" effect, we recommend that the plug-in nipple is held with one hand during uncoupling.

Areas of application: Pneumatic system, measurement, monitoring and control systems, manufacturing industry, medical technology, chemical / pharmaceutical industry, automotive, food technology.



Operating pressure	0 to 35 bar, maximum static working pressure (non-pulsating)
Medium temperature	-20 to 100 °C
Ambient temperature	-20 to 100 °C
Flow rate	560 l/min (air)
Flow rate measurement	at 6 bar and $\Delta p = 0.5$ bar
Housing	Nickel-plated brass
Sleeve	Nickel-plated brass
Valve body	Nickel-plated brass
Spring	Stainless steel
Retaining ring	Stainless steel
Locking pins	Stainless steel
Sealant	NBR

Quick disconnect coupling DN 5, nickel-plated brass, male

Art. No.	Type No.	Connection	Length mm	a/f mm
115621	243.18-N E	G 1/8 ET	35.9	14
115623	243.19-N E	G 1/4 ET	37.4	17
115625	243.19/S-N E	G 3/8 ET	37.4	19



243.19-N E

Quick disconnect coupling DN 5, nickel-plated brass, female

Art. No.	Type No.	Connection	Length mm	a/f mm
115627	243.20-N E	G 1/8 IT	35.9	14
115629	243.21-N E	G 1/4 IT	37.4	17
115631	243.21/S-N E	G 3/8 IT	37.4	19



243.21-N E

Quick disconnect coupling DN 5, nickel-plated brass, with hose stem

Art. No.	Type No.	Connection	Length mm	a/f mm
115635	243.25-N E	I.D. 4	41.9	14
115637	243.26-N E	I.D. 6	46.9	14
115639	243.26/S-N E	I.D. 9	46.9	14



243.26-N E



Quick disconnect coupling DN 5, nickel-plated brass, with hose connector

Art. No.	Type No.	Connection	Length mm	a/f mm
115641	243.27-N E	Hose connection 6x4	42.4	14
115643	243.28-N E	Hose connection 8x6	42.4	14



243.27-N E

Stems for couplings DN 5

nickel-plated brass



243.17-N

Stem for couplings DN 5, nickel-plated brass

Art. No.	Type No.	Connection	Length mm
107177	243.16-N	I.D. 4	27.0
107178	243.17-N	I.D. 6	32.0
107179	243.17/S-N	I.D. 9	34.0

Plugs for couplings DN 5

nickel-plated brass



243.032-N

Plug for couplings DN 5, nickel-plated brass, male

Art. No.	Type No.	Connection	Length mm	a/f mm
107184	243.031-N	G 1/8 ET	25.0	14
107185	243.032-N	G 1/4 ET	26.0	17
107186	243.032/S-N	G 3/8 ET	27.0	19



243.034-N

Plug for couplings DN 5, nickel-plated brass, female

Art. No.	Type No.	Connection	Length mm	a/f mm
107187	243.033-N	G 1/8 IT	25.0	14
107188	243.034-N	G 1/4 IT	26.0	17
107189	243.034/S-N	G 3/8 IT	26.0	19



243.29-N

Plug for couplings DN 5, nickel-plated brass, for hose

Art. No.	Type No.	Connection	Length mm	a/f mm
107180	243.29-N	for hose 6x4	32.0	14
107181	243.30-N	for hose 8x6	32.0	14



243.39/1-N

Plug for couplings DN 5, nickel-plated brass, for hose with swivel nut and kink protector

Art. No.	Type No.	Connection	Length mm	a/f mm
107182	243.39-N	for hose 6x4 with swivel nut and kink protector spring	110.0	12
107183	243.39/1-N	for hose 8x6 with swivel nut and kink protector spring	120.0	14



243.600-N

Push-in plug for couplings DN 5, nickel-plated brass

Art. No.	Type No.	Connection	Length mm	a/f mm
107190	243.600-N	push-in, 6 mm	33.0	14
107191	243.800-N	push-in, 8 mm	37.0	17

Quick disconnect couplings DN 5

»R21MS« series



PLUS

One-hand quick disconnect couplings, one side sealing, compact with a large bore and only a small pressure drop.

To prevent injuries or a "whiplash" effect, we recommend that the plug-in nipple is held with one hand during uncoupling.

Areas of application: Pneumatic system, measurement, monitoring and control systems, manufacturing industry, medical technology, chemical / pharmaceutical industry, automotive, food technology.

Operating pressure	0 to 35 bar, maximum static working pressure (non-pulsating)
Medium temperature	-20 to 100 °C
Ambient temperature	-20 to 100 °C
Flow rate	560 l/min (air)
Flow rate measurement	at 6 bar and $\Delta p = 0.5$ bar
Housing	Brass with a bare metal surface
Sleeve	Brass with a bare metal surface
Valve body	Brass with a bare metal surface
Spring	Stainless steel
Retaining ring	Stainless steel
Ball	Stainless steel
Sealant	NBR

Quick disconnect coupling DN 5, brass with a bare metal surface, male

Art. No.	Type No.	Connection	Length mm	a/f mm
107125	243.18	G 1/8 ET	37.0	14
107126	243.19	G 1/4 ET	38.0	17
107127	243.19/S	G 3/8 ET	38.0	19



243.18

Quick disconnect coupling DN 5, brass with a bare metal surface, female

Art. No.	Type No.	Connection	Length mm	a/f mm
107128	243.20	G 1/8 IT	38.0	14
107129	243.21	G 1/4 IT	38.0	17
107130	243.21/S	G 3/8 IT	40.0	19



243.21

Quick disconnect coupling DN 5, brass with a bare metal surface, with hose stem

Art. No.	Type No.	Connection	Length mm
107131	243.25	I.D. 4	47.0
107132	243.42	I.D. 5	46.0
107133	243.26	I.D. 6	46.0
107134	243.43	I.D. 8	46.0
107135	243.26/S	I.D. 9	46.0



243.26



Quick disconnect coupling DN 5, brass with a bare metal surface, with hose connector

Art. No.	Type No.	Connection	Length mm	a/f mm
107136	243.27	Hose connection 6x4	43.0	14
107137	243.28	Hose connection 8x6	43.0	14



243.27

Quick disconnect coupling DN 5, brass with a bare metal surface, with bulkhead fitting and hose stem

Art. No.	Type No.	Bulkhead fitting	Connection	Length mm	a/f mm
107138	243.31	M10x1	I.D. 4	60.0	14
107139	243.32	M12x1	I.D. 6	60.0	17
107140	243.34	M12x1	I.D. 9	60.0	17



243.32



Quick disconnect couplings DN 5

»R21MS« series

PLUS



243.36

Quick disconnect coupling DN 5, brass with a bare metal surface, with hose connector, swivel nut and kink protector spring

Art. No.	Type No.	Version	Connection	Length mm	a/f mm
107141	243.35	Rigid	Hose connection 6x4	120.0	14
107142	243.36	Rigid	Hose connection 8x6	132.0	14
107143	243.37	Swivelling 360°	Hose connection 6x4	134.0	14
107144	243.38	Swivelling 360°	Hose connection 8x6	145.0	14

→ Stems and plugs see page 477-478

Quick disconnect couplings DN 5

»R21MSV« series

PLUS

One-hand quick disconnect couplings, one side sealing, compact with a large bore and only a small pressure drop.

To prevent injuries or a "whiplash" effect, we recommend that the plug-in nipple is held with one hand during uncoupling.

Areas of application: Pneumatic system, measurement, monitoring and control systems, manufacturing industry, medical technology, chemical / pharmaceutical industry, automotive, food technology.

Operating pressure	0 to 35 bar, maximum static working pressure (non-pulsating)
Medium temperature	-20 to 100 °C
Ambient temperature	-20 to 100 °C
Flow rate	560 l/min (air)
Flow rate measurement	at 6 bar and $\Delta p = 0.5$ bar
Housing	Nickel-plated brass
Sleeve	Nickel-plated brass
Valve body	Nickel-plated brass
Spring	Stainless steel
Retaining ring	Stainless steel
Ball	Stainless steel
Sealant	NBR



243.19-N

Quick disconnect coupling DN 5, nickel-plated brass, male

Art. No.	Type No.	Connection	Length mm	a/f mm
107158	243.18-N	G 1/8 ET	36.5	14
107159	243.19-N	G 1/4 ET	38.0	17
107160	243.19/S-N	G 3/8 ET	38.0	19



243.21-N

Quick disconnect coupling DN 5, nickel-plated brass, female

Art. No.	Type No.	Connection	Length mm	a/f mm
107161	243.20-N	G 1/8 IT	38.0	14
107162	243.21-N	G 1/4 IT	38.0	17
107163	243.21/S-N	G 3/8 IT	40.0	19



243.26-N

Quick disconnect coupling DN 5, nickel-plated brass, with hose stem

Art. No.	Type No.	Connection	Length mm
107164	243.25-N	I.D. 4	47.0
107165	243.42-N	I.D. 5	46.0
107166	243.26-N	I.D. 6	46.0
107167	243.43-N	I.D. 8	46.0
107168	243.26/S-N	I.D. 9	46.0

Quick disconnect couplings DN 5

»R21MSV« series

PLUS ||



Quick disconnect coupling DN 5, nickel-plated brass, with hose connector

Art. No.	Type No.	Connection	Length mm	a/f mm
107169	243.27-N	Hose connection 6x4	43.0	14
107170	243.28-N	Hose connection 8x6	43.0	14



243.37-N

Quick disconnect coupling DN 5, nickel-plated brass, with hose connector, swivel nut and kink protector spring

Art. No.	Type No.	Version	Connection	Length mm	a/f mm
107171	243.35-N	Rigid	Hose connection 6x4	120.0	14
107172	243.36-N	Rigid	Hose connection 8x6	132.0	14
107173	243.37-N	Swivelling 360°	Hose connection 6x4	134.0	14
107174	243.38-N	Swivelling 360°	Hose connection 8x6	142.5	14



243.006-N

Quick disconnect coupling DN 5, nickel-plated brass, with push-in fitting

Art. No.	Type No.	Connection	Length mm	a/f mm
107175	243.006-N	6 mm	43.5	14
107176	243.008-N	8 mm	46.5	17



243.008-N

→ Stems and plugs see page 479-480

Quick disconnect couplings DN 5

»R21ES« series

One-hand quick disconnect couplings, one side sealing, made of stainless steel 1.4305, compact with a large bore.

To prevent injuries or a "whiplash" effect, we recommend that the plug-in nipple is held with one hand during uncoupling.

Areas of application: Pneumatic system, measurement, monitoring and control systems, manufacturing industry, medical technology, chemical / pharmaceutical industry, automotive, food technology, offshore.

Operating pressure	0 to 35 bar, maximum static working pressure (non-pulsating)
Medium temperature	-15 to 200 °C
Ambient temperature	-15 to 200 °C
Flow rate	560 l/min (air)
Flow rate measurement	at 6 bar and $\Delta p = 0.5$ bar
Housing	Stainless steel 1.4305
Sleeve	Stainless steel 1.4305
Valve body	Stainless steel 1.4305
Spring	Stainless steel
Retaining ring	Stainless steel
Ball	Stainless steel
Sealant	FKM



Quick disconnect coupling DN 5, stainless steel 1.4305, male

Art. No.	Type No.	Connection	Length mm	a/f mm
107192	243.330	G 1/8 ET	36.0	14
107193	243.331	G 1/4 ET	38.0	17
107194	243.332	G 3/8 ET	38.0	19



243.330



Quick disconnect couplings DN 5

»R21ES« series



243.431



243.532

Quick disconnect coupling DN 5, stainless steel 1.4305, female

Art. No.	Type No.	Connection	Length mm	a/f mm
107195	243.430	G 1/8 IT	36.0	14
107196	243.431	G 1/4 IT	38.0	17
107197	243.432	G 3/8 IT	38.0	19

Quick disconnect coupling DN 5, stainless steel 1.4305, with hose stem

Art. No.	Type No.	Connection	Length mm	a/f mm
107198	243.532	I.D. 6	46.0	14

Stems for couplings DN 5

stainless steel 1.4305



243.815

Stem for couplings DN 5, stainless steel 1.4305

Art. No.	Type No.	Connection	Length mm
107199	243.813	I.D. 6	32.0
107200	243.814	I.D. 8	32.0
107201	243.815	I.D. 9	33.0

Plugs for couplings DN 5

stainless steel 1.4305



243.856



243.875

Plug for couplings DN 5, stainless steel 1.4305, male

Art. No.	Type No.	Connection	Length mm	a/f mm
107202	243.855	G 1/8 ET	25.0	14
107203	243.856	G 1/4 ET	28.0	17
107204	243.857	G 3/8 ET	28.0	19

Plug for couplings DN 5, stainless steel 1.4305, female

Art. No.	Type No.	Connection	Length mm	a/f mm
107205	243.875	G 1/8 IT	25.0	14
107206	243.876	G 1/4 IT	26.0	17

Quick disconnect couplings DN 7.2

»R26EMS« series, connect line type



EASY

Universal, one-hand quick disconnect couplings, one side sealing, at an unbeatably low price.

The closed sleeve protects the coupling from dirt.

In combination with steel plugs, this coupling can also be used for pneumatic tools thanks to its hardened locking pins.

Couplings and plugs with thread sealing coating:

Ready-to assemble polyacrylate thread coating provides an instant, tight seal without curing.

The permanently elastic sealant can be adjusted up to 45° without influencing the seal. Safe to use.

Easy to assemble and disassemble.

To prevent injuries or a "whiplash" effect, we recommend that the plug-in nipple is held with one hand during uncoupling.

These quick disconnect couplings are not suitable for direct attachment to pulsating tools.

We recommend using our vibration dampers, according to ISO 6150 § 7.1.

Areas of application: Pneumatic system, machine and plant engineering, measurement, monitoring and control systems, manufacturing industry, medical technology, chemical / pharmaceutical industry, workshops, automotive.

Medium temperature	-20 to 100 °C
Ambient temperature	-20 to 100 °C
Flow rate	1000 l/min (air)
Flow rate measurement	at 6 bar and $\Delta p = 0.5$ bar
Housing	Brass with a bare metal surface
Sleeve	Brass with a bare metal surface
Valve body	Brass with a bare metal surface
Spring	Stainless steel
Retaining ring	Stainless steel
Locking pins	Stainless steel
Sealant	NBR

Quick disconnect coupling DN 7.2, brass with a bare metal surface, male

Art. No.	Type No.	Operating pressure	Connection	Length mm	a/f mm
115611	243.00-E	0 to 35 bar, maximum static working pressure (non-pulsating)	G 1/8 ET	37.5	21
115612	243.01-E	0 to 35 bar, maximum static working pressure (non-pulsating)	G 1/4 ET	39.0	21
115614	243.02-E	0 to 35 bar, maximum static working pressure (non-pulsating)	G 3/8 ET	39.0	21
115616	243.03-E	0 to 35 bar, maximum static working pressure (non-pulsating)	G 1/2 ET	40.5	21



243.01-E

Quick disconnect coupling DN 7.2, brass with a bare metal surface, male, with thread sealing coating

Art. No.	Type No.	Operating pressure	Connection	Length mm	a/f mm
117798	243.01-EB	0 to 12 bar, maximum static working pressure (non-pulsating)	G 1/4 ET	39.0	21
117807	243.02-EB	0 to 12 bar, maximum static working pressure (non-pulsating)	G 3/8 ET	39.0	21
117816	243.03-EB	0 to 12 bar, maximum static working pressure (non-pulsating)	G 1/2 ET	40.5	21



243.01-EB



Quick disconnect coupling DN 7.2, brass with a bare metal surface, female

Art. No.	Type No.	Operating pressure	Connection	Length mm	a/f mm
115618	243.11-E	0 to 35 bar, maximum static working pressure (non-pulsating)	G 1/4 IT	40.5	21
115632	243.22-E	0 to 35 bar, maximum static working pressure (non-pulsating)	G 3/8 IT	40.5	21
115644	243.33-E	0 to 35 bar, maximum static working pressure (non-pulsating)	G 1/2 IT	42.5	24



243.33-E

Quick disconnect coupling DN 7.2, brass with a bare metal surface, with hose stem

Art. No.	Type No.	Operating pressure	Connection	Length mm
115646	243.44-E	0 to 35 bar, maximum static working pressure (non-pulsating)	I.D. 6	54.0
115652	243.47-E	0 to 35 bar, maximum static working pressure (non-pulsating)	I.D. 8	54.0
115648	243.45-E	0 to 35 bar, maximum static working pressure (non-pulsating)	I.D. 9	54.0
115653	243.49-E	0 to 35 bar, maximum static working pressure (non-pulsating)	I.D. 10	54.0
115650	243.46-E	0 to 35 bar, maximum static working pressure (non-pulsating)	I.D. 13	53.5



243.44-E

→ You can find vibration dampers on page 851

→ Please note the following safety notice for the quick disconnect couplings with thread sealing coating:
Because of the ignorance which thread types, dimensions, materials, pairings and surfaces are prevailing, it is necessary to perform appropriate control tests of the desired function before a general application or a use in serial production under the respective practical conditions to convince themselves.
Any further claims, in particular the liability for consequential damages, are excluded.



Distributors

brass with a bare metal surface, with quick disconnect couplings DN 7.2, »R26EMS« series, connect line type

EASY

2-way distributor pieces made of brass with a bare metal surface, pre-assembled with quick disconnect coupling DN 7.2. Available with threaded connection inside or outside.

Operating pressure	0 - 35 bar
Medium temperature	-20 to 100 °C
Ambient temperature	-20 to 100 °C
Housing	Brass with a bare metal surface
Securing	Industrial adhesives, medium strength
Sealant	Industrial adhesives, medium strength



245.33-E



245.38-E

Distributor with 2 quick disconnect couplings DN 7.2, brass with a bare metal surface, male

Art. No.	Type No.	Conn ection	Comprising distributor	Couplings	Width mm	Height mm
117924	245.31-E	G 1/4 ET	Brass with a bare metal surface, G 3/8 IT	DN 7.2, brass with a bare metal surface, G 3/8 ET	89.0	84.0
117925	245.32-E	G 3/8 ET	Brass with a bare metal surface, G 3/8 IT	DN 7.2, brass with a bare metal surface, G 3/8 ET	90.0	85.0
117926	245.33-E	G 1/2 ET	Brass with a bare metal surface, G 1/2 IT	DN 7.2, brass with a bare metal surface, G 1/2 ET	91.0	89.0

Distributor with 2 quick disconnect couplings DN 7.2, brass with a bare metal surface, female

Art. No.	Type No.	Conn ection	Comprising distributor	Couplings	Width mm	Height mm
117927	245.36-E	G 1/4 IT	Brass with a bare metal surface, G 3/8 IT	DN 7.2, brass with a bare metal surface, G 3/8 ET	90.0	75.0
117928	245.37-E	G 3/8 IT	Brass with a bare metal surface, G 3/8 IT	DN 7.2, brass with a bare metal surface, G 3/8 ET	89.0	69.0
117929	245.38-E	G 1/2 IT	Brass with a bare metal surface, G 1/2 IT	DN 7.2, brass with a bare metal surface, G 1/2 ET	92.0	71.0

→ Couplings and distributors are also available separately

Stems for couplings DN 7.2 - DN 7.8

brass with a bare metal surface



243.351

Stem for couplings DN 7.2 - DN 7.8, brass with a bare metal surface

Art. No.	Type No.	Connection	Length mm
107232	243.06	I.D. 6	44.0
107233	243.351	I.D. 8	45.0
107234	243.07	I.D. 9	44.0
107235	243.352	I.D. 10	45.0
107236	243.10	I.D. 13	46.0

Plugs for couplings DN 7.2 - DN 7.8

brass with a bare metal surface

Plug for couplings DN 7.2 - DN 7.8, brass with a bare metal surface, male

Art. No.	Type No.	Connection	Length mm	a/f mm
107237	243.48	G 1/8 ET	31.0	14
107238	243.50	G 1/4 ET	32.0	17
107239	243.51	G 3/8 ET	33.0	19
107240	243.52	G 1/2 ET	35.0	24



243.50

Plug for couplings DN 7.2 - DN 7.8, brass with a bare metal surface, male, with thread sealing coating

Art. No.	Type No.	Connection	Length mm	a/f mm
125654	243.50-EB	G 1/4 ET	32.0	17
125655	243.51-EB	G 3/8 ET	33.0	19
125656	243.52-EB	G 1/2 ET	35.0	24
117890	243.50-R	R 1/4 AG	32.0	17



243.50-EB

Plug for couplings DN 7.2 - DN 7.8, brass with a bare metal surface, female

Art. No.	Type No.	Connection	Length mm	a/f mm
107241	243.54	G 1/8 IT	31.0	14
107242	243.55	G 1/4 IT	32.0	17
107243	243.56	G 3/8 IT	32.0	19
107244	243.57	G 1/2 IT	34.0	24



243.55

Plug for couplings DN 7.2 - DN 7.8, brass with a bare metal surface, for hose

Art. No.	Type No.	Connection	Length mm	a/f mm
107245	243.216	for hose 6x4	41.0	14
107246	243.217	for hose 8x6	43.0	14
107247	243.218	for hose 10x8	38.0	17
107248	243.219	for hose 12x9	42.0	17



243.216

Plug for couplings DN 7.2 - DN 7.8, brass with a bare metal surface, for hose with swivel nut and kink protector spring

Art. No.	Type No.	Connection	Length mm	a/f mm
107249	243.355	for hose 6x4 with swivel nut and kink protector spring	112.0	
107250	243.356	for hose 8x6 with swivel nut and kink protector spring	120.0	
107251	243.357	for hose 10x8 with swivel nut and kink protector spring	145.0	17
107252	243.358	for hose 12x9 with swivel nut and kink protector spring	120.0	17



243.355



Push-in elbows for couplings DN 7.2 - DN 7.8

brass with a bare metal surface

Push-in elbow for couplings DN 7.2 - DN 7.8, brass with a bare metal surface

Art. No.	Type No.	Connection	Width mm	Height mm
107253	243.760	for hose 6x4	45.0	26.0



243.760

Assortment box, quick disconnect couplings

Quick disconnect couplings and push-in plugs DN 7.2, »connect line«, brass with a bare metal surface

EASY

Easy to handle, durable and high quality plastic assortment box with the most common items of our quick disconnect couplings DN 7.2, plug-in connectors and nipples.

The most common brass couplings DN 7.2 as well as the associated plug nipples are clearly presented in 19 plastic boxes.

The inserts can be taken out and are placed in the box itself.

All inserts are inscripted with the item numbers of the parts contained in them.

25 Quick disconnect couplings, male:
10 x G 1/4 • 5 x G 3/8 • 10 x G 1/2

15 Quick disconnect couplings, female:
5 x G 1/4 • 5 x G 3/8 • 5 x G 1/2

15 Quick disconnect couplings, with hose stem:
5 x I. D. 6 • 5 x I. D. 9 • 5 x I. D. 13

15 Stems:
5 x I. D. 6 • 5 x I. D. 9 • 5 x I. D. 13

15 Plugs, male:
5 x G 1/4 • 5 x G 3/8 • 5 x G 1/2

15 Plugs, female:
5 x G 1/4 • 5 x G 3/8 • 5 x G 1/2

1 PTFE seal belt

1 x Lock AN 302-43 / 10 ml



KSB 500

Assortment box, quick disconnect couplings DN 7.2, »connect line«

Art. No.	Type No.	Description
131696	KSB 500	Assortment box with quick disconnect couplings DN 7.2

- Boxed set push-in fittings »click-clock« series see on page 648
- Boxed sets push-in fittings »Blue Series« see on page 622
- Boxed sets, brass turned parts see at page 712
- Boxed sets, hose clamps see at page 884

Quick disconnect couplings DN 7.2

»R26EMSV« series, connect line type



EASY

Universal, one-hand quick disconnect couplings, one side sealing, at an unbeatably low price. The closed sleeve protects the coupling from dirt. In combination with steel plugs, this coupling can also be used for pneumatic tools thanks to its hardened locking pins. To prevent injuries or a "whiplash" effect, we recommend that the plug-in nipple is held with one hand during uncoupling.

These quick disconnect couplings are not suitable for direct attachment to pulsating tools. We recommend using our vibration dampers, according to ISO 6150 § 7.1.

Areas of application: Pneumatic system, machine and plant engineering, measurement, monitoring and control systems, manufacturing industry, medical technology, chemical / pharmaceutical industry, workshops, automotive.

Operating pressure	0 to 35 bar, maximum static working pressure (non-pulsating)
Medium temperature	-20 to 100 °C
Ambient temperature	-20 to 100 °C
Flow rate	1000 l/min (air)
Flow rate measurement	at 6 bar and $\Delta p = 0.5$ bar
Housing	Nickel-plated brass
Sleeve	Nickel-plated brass
Valve body	Nickel-plated brass
Spring	Stainless steel
Retaining ring	Stainless steel
Locking pins	Stainless steel
Sealant	NBR

Quick disconnect coupling DN 7.2, nickel-plated brass, male

Art. No.	Type No.	Connection	Length mm	a/f mm
115613	243.01-N E	G 1/4 ET	39.0	21
115615	243.02-N E	G 3/8 ET	39.0	21
115617	243.03-N E	G 1/2 ET	40.5	21



243.03-N E

Quick disconnect coupling DN 7.2, nickel-plated brass, female

Art. No.	Type No.	Connection	Length mm	a/f mm
115619	243.11-N E	G 1/4 IT	40.5	21
115633	243.22-N E	G 3/8 IT	40.5	21
115645	243.33-N E	G 1/2 IT	42.5	24



243.33-N E

Quick disconnect coupling DN 7.2, nickel-plated brass, with hose stem

Art. No.	Type No.	Connection	Length mm
115647	243.44-N E	I.D. 6	54.0
115649	243.45-N E	I.D. 9	54.0
115651	243.46-N E	I.D. 13	53.5



243.45-N E

→ You can find vibration dampers on page 851



Stems for couplings DN 7.2 - DN 7.8

nickel-plated brass



243.351-N

Stem for couplings DN 7.2 - DN 7.8, nickel-plated brass

Art. No.	Type No.	Connection	Length mm
107300	243.06-N	I.D. 6	44.0
107301	243.351-N	I.D. 8	45.0
107302	243.07-N	I.D. 9	44.0
107303	243.352-N	I.D. 10	45.0
107304	243.10-N	I.D. 13	46.0

Plugs for couplings DN 7.2 - DN 7.8

nickel-plated brass



243.50-N

Plug for couplings DN 7.2 - DN 7.8, nickel-plated brass, male

Art. No.	Type No.	Connection	Length mm	a/f mm
107305	243.48-N	G 1/8 ET	31.0	14
107306	243.50-N	G 1/4 ET	32.0	17
107307	243.51-N	G 3/8 ET	33.0	19
107308	243.52-N	G 1/2 ET	35.0	24



243.55-N

Plug for couplings DN 7.2 - DN 7.8, nickel-plated brass, female

Art. No.	Type No.	Connection	Length mm	a/f mm
107309	243.54-N	G 1/8 IT	31.0	14
107310	243.55-N	G 1/4 IT	32.0	17
107311	243.56-N	G 3/8 IT	32.0	19
107312	243.57-N	G 1/2 IT	34.0	24



243.216-N

Plug for couplings DN 7.2 - DN 7.8, nickel-plated brass, for hose

Art. No.	Type No.	Connection	Length mm	a/f mm
107313	243.216-N	for hose 6x4	34.0	12
107314	243.217-N	for hose 8x6	34.0	14
107315	243.218-N	for hose 10x8	42.0	17



243.357-N

Plug for couplings DN 7.2 - DN 7.8, nickel-plated brass, for hose with swivel nut and kink protector spring

Art. No.	Type No.	Connection	Length mm	a/f mm
107316	243.355-N	for hose 6x4 with swivel nut and kink protector spring	112.0	
107317	243.356-N	for hose 8x6 with swivel nut and kink protector spring	120.0	14
107318	243.357-N	for hose 10x8 with swivel nut and kink protector spring	140.0	19
107319	243.358-N	for hose 12x9 with swivel nut and kink protector spring	120.0	19

Push-in elbow for couplings DN 7.2 - DN 7.8

nickel-plated brass

Push-in elbow for couplings DN 7.2 - DN 7.8, nickel-plated brass

Art. No.	Type No.	Connection	Width mm	Height mm
107254	243.761	for hose 8x6	48.0	27.0



243.761

Plugs for couplings DN 7.2 - DN 7.8, swivel type

nickel-plated brass

Plug for couplings DN 7.2 - DN 7.8, swivel type, nickel-plated brass

Art. No.	Type No.	Connection	Length mm	a/f mm
107320	243.981	G 1/4 IT	53.0	22
107321	243.982	G 1/4 ET	53.0	22



243.981



243.982

Hose stems, swivel type, nickel-plated brass / steel

nickel-plated brass

Hose stem for couplings DN 7.2 - DN 7.8, swivel type, nickel-plated brass / steel, male

Art. No.	Type No.	Connection	Material	I.D. mm	Length mm	a/f mm
107322	243.993	G 1/4 ET	Nickel-plated brass	6	58.0	22
107323	243.994	G 1/4 ET	Nickel-plated brass	8	58.0	22
107324	243.9960	G 1/4 ET	Nickel-plated brass	9	58.0	22
107325	243.999	G 1/4 ET	Nickel-plated brass	10	58.0	22
107326	243.1000	G 1/4 ET	Nickel-plated brass	13	58.0	22
107327	243.997	R 3/8 ET	Nickel-plated steel	6	54.0	19
107328	243.998	R 3/8 ET	Nickel-plated steel	9	54.0	19



243.999



243.997

Hose stem for couplings DN 7.2 - DN 7.8, swivel type, nickel-plated brass, female

Art. No.	Type No.	Connection	I.D. mm	Length mm	a/f mm
107329	243.1001	G 1/4 IT	6	59.0	22
107330	243.1002	G 1/4 IT	8	59.0	22
107331	243.1003	G 1/4 IT	9	59.0	22
107332	243.1004	G 1/4 IT	10	59.0	22
107333	243.1005	G 1/4 IT	13	59.0	22



243.1004





Quick disconnect couplings DN 7.2

»R26MS« series

PLUS

Universal, one-hand quick disconnect couplings, one side sealing, suitable for a wide range of tasks and applications!

The closed sleeve protects the coupling from dirt.

To prevent injuries or a "whiplash" effect, we recommend that the plug-in nipple is held with one hand during uncoupling.

These quick disconnect couplings are not suitable for direct attachment to pulsating tools. We recommend using our vibration dampers, according to ISO 6150 § 7.1.

Areas of application: Pneumatic system, machine and plant engineering, measurement, monitoring and control systems, manufacturing industry, medical technology, chemical / pharmaceutical industry, workshops, automotive.

Operating pressure	0 to 35 bar, maximum static working pressure (non-pulsating)
Medium temperature	-20 to 100 °C
Ambient temperature	-20 to 100 °C
Flow rate	1000 l/min (air)
Flow rate measurement	at 6 bar and $\Delta p = 0.5$ bar
Housing	Brass with a bare metal surface
Sleeve	Brass with a bare metal surface
Valve body	Brass with a bare metal surface
Spring	Stainless steel
Retaining ring	Stainless steel
Locking pins	Stainless steel
Sealant	NBR



243.01

Quick disconnect coupling DN 7.2, brass with a bare metal surface, male

Art. No.	Type No.	Connection	Length mm	a/f mm
107207	243.00	G 1/8 ET	38.0	22
107208	243.01	G 1/4 ET	40.0	22
107209	243.02	G 3/8 ET	41.0	22
107210	243.03	G 1/2 ET	41.0	24



243.11

Quick disconnect coupling DN 7.2, brass with a bare metal surface, female

Art. No.	Type No.	Connection	Length mm	a/f mm
107211	243.11	G 1/4 IT	41.0	22
107212	243.22	G 3/8 IT	41.0	22
107213	243.33	G 1/2 IT	42.5	24



243.44

Quick disconnect coupling DN 7.2, brass with a bare metal surface, with hose stem

Art. No.	Type No.	Connection	Length mm	a/f mm
107214	243.44	I.D. 6	58.0	21
107215	243.47	I.D. 8	58.0	21
107216	243.45	I.D. 9	63.0	21
107217	243.49	I.D. 10	63.0	21
107218	243.46	I.D. 13	63.0	21



243.311

Quick disconnect coupling DN 7.2, brass with a bare metal surface, with hose connector, with swivel nut

Art. No.	Type No.	Connection	Length mm	a/f mm
107219	243.310	Hose connection 6x4	44.0	22
107220	243.311	Hose connection 8x6	45.0	22
107221	243.312	Hose connection 10x8	48.0	22
107222	243.313	Hose connection 12x9	48.0	22

Quick disconnect couplings DN 7.2

»R26MS« series

PLUS



Quick disconnect coupling DN 7.2, brass with a bare metal surface, with hose connector, with swivel nut and kink protector spring

Art. No.	Type No.	Version	Connection	Length mm	a/f mm
107223	243.320	Rigid	Hose connection 8x6	132.0	22
107224	243.321	Rigid	Hose connection 10x8	126.0	22
107225	243.322	Rigid	Hose connection 12x9	126.0	22



243.320

Quick disconnect coupling DN 7.2, brass with a bare metal surface, with bulkhead fitting and hose stem

Art. No.	Type No.	Bulkhead fitting	Connection	Length mm	a/f mm
107229	243.340	M12x1	I.D. 6	62.0	22
107230	243.341	M12x1	I.D. 8	62.0	22
107231	243.342	G 1/4	I.D. 10	70.0	22



243.340

- 1-, 2- and 3-way distributor pieces with DN 7.2 couplings you can find on page 493-494
- You can find vibration dampers on page 851
- Stems and plugs see page 486

Distributors

brass with a bare metal surface, with quick disconnect couplings DN 7.2, »R26MS« series

PLUS

1, 2 or 3-way distributor pieces made of brass with a bare metal surface, pre-assembled with quick disconnect coupling DN 7.2.

Available with threaded connection inside or outside or nipple for adaptation into an existing quick disconnect coupling DN 7.2 to DN 7.8.

Operating pressure	0 - 35 bar
Medium temperature	-20 to 100 °C
Ambient temperature	-20 to 100 °C
Housing	Brass with a bare metal surface
Securing	Industrial adhesives, medium strength
Sealant	Industrial adhesives, medium strength



Distributor with 2 quick disconnect couplings DN 7.2, brass with a bare metal surface, male

Art. No.	Type No.	Connection	Comprising distributor	Couplings
107256	245.31	G 1/4 ET	Brass with a bare metal surface, G 3/8 IT	DN 7.2, brass with a bare metal surface, G 3/8 ET
107257	245.32	G 3/8 ET	Brass with a bare metal surface, G 3/8 IT	DN 7.2, brass with a bare metal surface, G 3/8 ET
107258	245.33	G 1/2 ET	Brass with a bare metal surface, G 1/2 IT	DN 7.2, brass with a bare metal surface, G 1/2 ET



245.33

Distributor with 2 quick disconnect couplings DN 7.2, brass with a bare metal surface, female

Art. No.	Type No.	Connection	Comprising distributor	Couplings
107259	245.36	G 1/4 IT	Brass with a bare metal surface, G 3/8 IT	DN 7.2, brass with a bare metal surface, G 3/8 ET
107260	245.37	G 3/8 IT	Brass with a bare metal surface, G 3/8 IT	DN 7.2, brass with a bare metal surface, G 3/8 ET
107261	245.38	G 1/2 IT	Brass with a bare metal surface, G 1/2 IT	DN 7.2, brass with a bare metal surface, G 1/2 ET



245.38



Distributors

brass with a bare metal surface, with quick disconnect couplings DN 7.2, »R26MS« series

PLUS



245.39

Distributor with 2 quick disconnect couplings DN 7.2, brass with a bare metal surface, with push-in plugs DN 7.2 - DN 7.8

Art. No.	Type No.	Connection	Comprising distributor	Couplings
107262	245.39	Plug DN 7.2 to 7.8 / G 3/8	Brass with a bare metal surface, G 3/8 IT	DN 7.2, brass with a bare metal surface, G 3/8 ET
107263	245.40	Plug DN 7.2 to 7.8 / G 1/2	Brass with a bare metal surface, G 1/2 IT	DN 7.2, brass with a bare metal surface, G 1/2 ET



245.53

Distributor with 3 quick disconnect couplings DN 7.2, brass with a bare metal surface, male

Art. No.	Type No.	Connection	Comprising distributor	Couplings
107264	245.51	G 1/4 ET	Brass with a bare metal surface, G 3/8 IT	DN 7.2, brass with a bare metal surface, G 3/8 ET
107265	245.52	G 3/8 ET	Brass with a bare metal surface, G 3/8 IT	DN 7.2, brass with a bare metal surface, G 3/8 ET
107266	245.53	G 1/2 ET	Brass with a bare metal surface, G 1/2 IT	DN 7.2, brass with a bare metal surface, G 1/2 ET



245.58

Distributor with 3 quick disconnect couplings DN 7.2, brass with a bare metal surface, female

Art. No.	Type No.	Connection	Comprising distributor	Couplings
107267	245.56	G 1/4 IT	Brass with a bare metal surface, G 3/8 IT	DN 7.2, brass with a bare metal surface, G 3/8 ET
107268	245.57	G 3/8 IT	Brass with a bare metal surface, G 3/8 IT	DN 7.2, brass with a bare metal surface, G 3/8 ET
107269	245.58	G 1/2 IT	Brass with a bare metal surface, G 1/2 IT	DN 7.2, brass with a bare metal surface, G 1/2 ET



245.60

Distributor with 3 quick disconnect couplings DN 7.2, brass with a bare metal surface, with push-in plugs DN 7.2 - DN 7.8

Art. No.	Type No.	Connection	Comprising distributor	Couplings
107270	245.59	Plug DN 7.2 to 7.8 / G 3/8	Brass with a bare metal surface, G 3/8 IT	DN 7.2, brass with a bare metal surface, G 3/8 ET
107271	245.60	Plug DN 7.2 to 7.8 / G 1/2	Brass with a bare metal surface, G 1/2 IT	DN 7.2, brass with a bare metal surface, G 1/2 ET



VT 1020-K

Distributor for wall mountable with quick disconnect coupling NW 7.2, brass with a bare metal surface

Art. No.	Type No.	Connection	Comprising distributor	Couplings
107272	VT 1020-K	G 1/2 IT	5 x G 1/2 outlets	DN 7.2, brass with a bare metal surface, G 1/2 ET



DW 267-K

Wall plate with quick disconnect coupling DN 7.2, brass with a bare metal surface

Art. No.	Type No.	Connection	Comprising distributor	Couplings
107273	DW 266-K	G 3/8 IT	2 x G 3/8 IT	DN 7.2, brass with a bare metal surface, G 3/8 ET
107274	DW 267-K	G 1/2 IT	2 x G 1/2 IT	DN 7.2, brass with a bare metal surface, G 1/2 ET

→ Couplings and distributors are also available separately

Distributor socket

plastic, with quick disconnect couplings DN 7.2, »R26MS« series



PLUS

2 or 3-way distributor sockets made of high-strength glass fibre-reinforced plastic (PA6 GF 30) for a wide range of applications. Available with 2 or 3 pre-assembled, brass quick disconnect couplings and 2 inlet thread sizes for input and output threads (Not combinable). All distributor sockets have a durable brass threaded insert, whose shape secures it against rotation and against axial shift due to its shape. Drilling diagram dimensions are identical for all distributor sockets, so a simpler and more flexible exchange replacement. Caution: Note that the distributor sockets should not be installed in danger zones. Danger zones are, for example, transport routes, escape routes, etc.

Max. operating pressure	15 bar
Housing	Glass fibre-reinforced plastic PA6 GF 30
Thread material	Brass
Max. tightening torque brass thread	12 Nm
Max. tightening torque mounting holes	4 Nm

End distributor socket without through-hole thread, with quick disconnect couplings DN 7.2

Art. No.	Type No.	Inlet thread	Coupling	Width mm	Height mm
107275	EVDK12-2	G 1/2	2 x brass coupling	120.0	59.0
107276	EVDK12-3	G 1/2	3 x brass coupling	120.0	59.0
107277	EVDK34-2	G 3/4	2 x brass coupling	120.0	59.0
107278	EVDK34-3	G 3/4	3 x brass coupling	120.0	59.0



EVDK12-2



Assortment box, quick disconnect couplings

Quick disconnect couplings and push-in plugs DN 7.2, brass with a bare metal surface

PLUS

Easy to handle, durable and high quality plastic assortment box with the most common items of our quick disconnect couplings DN 7.2, plug-in connectors and nipples.

The most common brass couplings DN 7.2 as well as the associated plug nipples are clearly presented in 19 plastic boxes.

The inserts can be taken out and are placed in the box itself.

All inserts are inscripted with the item numbers of the parts contained in them.

25 Quick disconnect couplings, male:
10 x G 1/4 • 5 x G 3/8 • 10 x G 1/2

15 Quick disconnect couplings, female:
5 x G 1/4 • 5 x G 3/8 • 5 x G 1/2

15 Quick disconnect couplings, with hose stem:
5 x I. D. 6 • 5 x I. D. 9 • 5 x I. D. 13

15 Stems:
5 x I. D. 6 • 5 x I. D. 9 • 5 x I. D. 13

15 Plugs, male:
5 x G 1/4 • 5 x G 3/8 • 5 x G 1/2

15 Plugs, female:
5 x G 1/4 • 5 x G 3/8 • 5 x G 1/2

1 PTFE seal belt

1 x Lock AN 302-43 / 10 ml



KSB 600

Assortment box, quick disconnect couplings DN 7.2

Art. No.	Type No.	Description
135936	KSB 600	Assortment box with quick disconnect couplings DN 7.2

- Boxed set push-in fittings »click-clock« series see on page 648
- Boxed sets push-in fittings »Blue Series« see on page 622
- Boxed sets, brass turned parts see at page 712
- Boxed sets, hose clamps see at page 884

Quick disconnect couplings DN 7.2

»R26MSV« series



PLUS

Universal, one-hand quick disconnect couplings, one side sealing, suitable for a wide range of tasks and applications!

The closed sleeve protects the coupling from dirt.

To prevent injuries or a "whiplash" effect, we recommend that the plug-in nipple is held with one hand during uncoupling.

These quick disconnect couplings are not suitable for direct attachment to pulsating tools. We recommend using our vibration dampers, according to ISO 6150 § 7.1.

Areas of application: Pneumatic system, machine and plant engineering, measurement, monitoring and control systems, manufacturing industry, medical technology, chemical / pharmaceutical industry, workshops, automotive.

Operating pressure	0 to 35 bar, maximum static working pressure (non-pulsating)
Flow rate	1000 l/min (air)
Flow rate measurement	at 6 bar and $\Delta p_p = 0.5$ bar
Housing	Nickel-plated brass
Sleeve	Nickel-plated brass
Valve body	Brass with a bare metal surface
Spring	Stainless steel 1.4310
Retaining ring	Stainless steel 1.4310
Locking pins	Stainless steel 1.4034
Sealant	NBR

Quick disconnect coupling DN 7.2, nickel-plated brass, male						
Art. No.	Type No.	Medium temperature °C	Ambient temperature °C	Connection	Length mm	a/f mm
107279	243.00-N	-20 to 100	-20 to 100	G 1/8 ET	38.0	22
107280	243.01-N	-20 to 100	-20 to 100	G 1/4 ET	40.0	22
107281	243.02-N	-20 to 100	-20 to 100	G 3/8 ET	45.0	22
107282	243.03-N	-20 to 100	-20 to 100	G 1/2 ET	41.0	24



243.03-N

Quick disconnect coupling DN 7.2, nickel-plated brass, female						
Art. No.	Type No.	Medium temperature °C	Ambient temperature °C	Connection	Length mm	a/f mm
107283	243.11-N	-20 to 100	-20 to 100	G 1/4 IT	41.0	22
107284	243.22-N	-20 to 100	-20 to 100	G 3/8 IT	41.0	22
107285	243.33-N	-20 to 100	-20 to 100	G 1/2 IT	42.5	24



243.33-N

Quick disconnect coupling DN 7.2, nickel-plated brass, with hose stem						
Art. No.	Type No.	Medium temperature °C	Ambient temperature °C	Connection	Length mm	a/f mm
107286	243.44-N	-20 to 100	-20 to 100	I.D. 6	58.0	21
107287	243.47-N	-20 to 100	-20 to 100	I.D. 8	63.0	21
107288	243.45-N	-20 to 100	-20 to 100	I.D. 9	58.0	21
107289	243.49-N	-20 to 100	-20 to 100	I.D. 10	63.0	21
107290	243.46-N	-20 to 100	-20 to 100	I.D. 13	58.0	21



243.45-N



Quick disconnect coupling DN 7.2, nickel-plated brass, with hose connector, with swivel nut						
Art. No.	Type No.	Medium temperature °C	Ambient temperature °C	Connection	Length mm	a/f mm
107291	243.310-N	-20 to 100	-20 to 100	Hose connection 6x4	44.0	22
107292	243.311-N	-20 to 100	-20 to 100	Hose connection 8x6	45.0	22
107293	243.312-N	-20 to 100	-20 to 100	Hose connection 10x8	48.0	22
107294	243.313-N	-20 to 100	-20 to 100	Hose connection 12x9	48.0	22



243.311-N



243.403-N

Quick disconnect couplings DN 7.2

»R26MSV« series

PLUS

Quick disconnect coupling DN 7.2, nickel-plated brass, swivel type

Art. No.	Type No.	Medium temperature °C	Ambient temperature °C	Connection	Length mm
107295	243.400-N	0 to 70	0 to 70	Stem 6 mm, swivel type	74.0
107296	243.401-N	0 to 70	0 to 70	Stem 8 mm, swivel type	74.0
107297	243.402-N	0 to 70	0 to 70	Stem 9 mm, swivel type	74.0
107298	243.403-N	0 to 70	0 to 70	Stem 10 mm, swivel type	74.0
107299	243.404-N	0 to 70	0 to 70	Stem 13 mm, swivel type	74.0

- You can find vibration dampers on page 851
- Stems and plugs see page 489-490

Quick disconnect couplings DN 7.2

»R26ES« series

Classic standard coupling type, one side sealing, made of stainless steel.

The closed sleeve protects the coupling from dirt.

We recommend the use of stainless steel plugs and stems!

To prevent injuries or a "whiplash" effect, we recommend that the plug-in nipple is held with one hand during uncoupling.

These quick disconnect couplings are not suitable for direct attachment to pulsating tools. We recommend using our vibration dampers, according to ISO 6150 § 7.1.

Areas of application: Pneumatic system, machine and plant engineering, measurement, monitoring and control systems, manufacturing industry, chemical / pharmaceutical industry, workshops, automotive, offshore.

Max. operating pressure	35 bar
Medium temperature	-25 to 200 °C
Ambient temperature	-25 to 200 °C
Flow rate	1000 l/min (air)
Flow rate measurement	at 6 bar and $\Delta p = 0.5$ bar
Spring	Stainless steel 1.4310
Retaining ring	Stainless steel 1.4310
Locking pins	Stainless steel 1.4401
Sealant	FKM



243.103

Quick disconnect coupling DN 7.2, stainless steel 1.4305, male

Art. No.	Type No.	Connection	Length mm	a/f mm	Housing	Sleeve	Valve body
107334	243.101	G 1/4 ET	43.0	22	Stainless steel 1.4305	Stainless steel 1.4305	Stainless steel 1.4305
107335	243.102	G 3/8 ET	43.0	22	Stainless steel 1.4305	Stainless steel 1.4305	Stainless steel 1.4305
107336	243.103	G 1/2 ET	46.0	24	Stainless steel 1.4305	Stainless steel 1.4305	Stainless steel 1.4305



243.133

Quick disconnect coupling DN 7.2, stainless steel 1.4305 / 1.4301, female

Art. No.	Type No.	Connection	Length mm	a/f mm	Housing	Sleeve	Valve body
107337	243.111	G 1/4 IT	43.0	22	Stainless steel 1.4305	Stainless steel 1.4305	Stainless steel 1.4305
107338	243.122	G 3/8 IT	43.0	22	Stainless steel 1.4305	Stainless steel 1.4305	Stainless steel 1.4305
107339	243.133	G 1/2 IT	46.0	24	Stainless steel 1.4305	Stainless steel 1.4305	Stainless steel 1.4305

Quick disconnect couplings DN 7.2

»R26ES« series



Quick disconnect coupling DN 7.2, stainless steel 1.4305 / 1.4301, with hose stem							
Art. No.	Type No.	Connection	Length mm	a/f mm	Housing	Sleeve	Valve body
107340	243.144	I.D. 6	59.0	22	Stainless steel 1.4305	Stainless steel 1.4305	Stainless steel 1.4305
107341	243.144-8	I.D. 8	59.0	22	Stainless steel 1.4305	Stainless steel 1.4305	Stainless steel 1.4305
107342	243.145	I.D. 9	59.0	22	Stainless steel 1.4305	Stainless steel 1.4305	Stainless steel 1.4305
107343	243.145-10	I.D. 10	59.0	22	Stainless steel 1.4305	Stainless steel 1.4305	Stainless steel 1.4305
107344	243.146	I.D. 13	59.0	22	Stainless steel 1.4305	Stainless steel 1.4305	Stainless steel 1.4305



243.144

→ Vibration dampers on request

Stems for couplings DN 7.2 - DN 7.8

stainless steel 1.4305

Stem for couplings DN 7.2 - DN 7.8, stainless steel 1.4305				
Art. No.	Type No.	Connection	Length mm	
107345	243.106	I.D. 6	46.0	
107346	243.106-8	I.D. 8	48.0	
107347	243.107	I.D. 9	46.0	
107348	243.108	I.D. 10	46.0	
107349	243.110	I.D. 13	46.0	



243.107

Plugs for couplings DN 7.2 - DN 7.8

stainless steel 1.4305

Plug for couplings DN 7.2 - DN 7.8, stainless steel 1.4305, male				
Art. No.	Type No.	Connection	Length mm	a/f mm
107350	243.150	G 1/4 ET	33.0	17
107351	243.151	G 3/8 ET	33.0	19
107352	243.152	G 1/2 ET	38.0	24

Plug for couplings DN 7.2 - DN 7.8, stainless steel 1.4305, female				
Art. No.	Type No.	Connection	Length mm	a/f mm
107353	243.155	G 1/4 IT	33.0	17
107354	243.156	G 3/8 IT	33.0	19
107355	243.157	G 1/2 IT	36.0	24



243.152



243.157





Quick disconnect couplings DN 7.8

»R25ST« series

PLUS

Single-sided blocking, high quality and robust quick connect coupling for high flow values. To prevent injuries or a "whiplash" effect, we recommend that the plug-in nipple is held with one hand during uncoupling.

These quick disconnect couplings are not suitable for direct attachment to pulsating tools. We recommend using our vibration dampers, according to ISO 6150 § 7.1.

Areas of application: Pneumatic system, machine and plant engineering, measurement, monitoring and control systems, manufacturing industry, medical technology, chemical / pharmaceutical industry, workshops, automotive, mining.

Operating pressure	0 - 35 bar
Medium temperature	-20 to 100 °C
Ambient temperature	-20 to 100 °C
Flow rate	2000 l/min (air)
Flow rate measurement	at 6 bar and $\Delta p = 0.5$ bar
Housing	Galvanised steel
Valve	Die-cast zinc (zamac)
Spring	Stainless steel
Sleeve	Galvanised steel
Ball	Stainless steel
Threaded piece	Galvanised steel
Sealant	NBR



244.62-E

Quick disconnect coupling DN 7.8, galvanised steel, male

Art. No.	Type No.	Connection	Length mm	a/f mm
141512	244.61-E	R 1/4 ET	59.0	19
141513	244.62-E	R 3/8 ET	61.0	19
141514	244.63-E	R 1/2 ET	55.0	22



244.72-E

Quick disconnect coupling DN 7.8, galvanised steel, female

Art. No.	Type No.	Connection	Length mm	a/f mm
141515	244.71-E	G 1/4 IT	54.0	19
141516	244.72-E	G 3/8 IT	54.0	19
141517	244.73-E	G 1/2 IT	56.0	24



244.83-E

Quick disconnect coupling DN 7.8, galvanised steel, with hose stem

Art. No.	Type No.	Connection	Length mm	a/f mm
141518	244.81-E	I.D. 6	70.0	19
141519	244.82-E	I.D. 8	70.0	19
141520	244.85-E	I.D. 9	70.0	19
141521	244.83-E	I.D. 10	70.0	19
141522	244.84-E	I.D. 13	70.0	19



244.91-1-E

Quick disconnect coupling DN 7.8, galvanised steel, with hose connector

Art. No.	Type No.	Connection	Length mm	a/f mm
141523	244.90-E	Hose connection 8x6	61.0	19
141524	244.91-1-E	Hose connection 10x8	64.0	19
141525	244.92-1-E	Hose connection 12x9	64.0	19

Quick disconnect couplings DN 7.8

»R25ST« series

PLUS



Quick disconnect coupling DN 7.8, galvanised steel, with bulkhead fitting and hose stem

Art. No.	Type No.	Bulkhead fitting	Connection	Length mm	a/f mm
141529	244.51-E	M12x1	I.D. 6	79.0	19
141530	244.52-E	M12x1	I.D. 8	79.0	19
141531	244.53-E	G 1/4	I.D. 10	79.0	19



244.52-E

→ You can find vibration dampers on page 851

→ Other types can be found online

Stems for couplings DN 7.2 - DN 7.8

Galvanised steel

Stem for couplings DN 7.2 - DN 7.8, galvanised steel

Art. No.	Type No.	Connection	Length mm
141532	244.571	I.D. 6	46.0
141533	244.572	I.D. 8	46.0
141534	244.573	I.D. 9	46.0
141535	244.574	I.D. 10	48.0
141536	244.575	I.D. 13	48.0
141537	244.576	I.D. 16	46.0



244.574

Plugs for couplings DN 7.2 - DN 7.8

Galvanised steel

Plug for couplings DN 7.2 - DN 7.8, galvanised steel, male with thread coating

Art. No.	Type No.	Connection	Length mm	a/f mm
141545	244.560	R 1/8 ET	33.0	13
141546	244.561	R 1/4 ET	37.0	14
141547	244.562	R 3/8 ET	37.0	17
141548	244.563	R 1/2 ET	43.0	22



244.562



Plug for couplings DN 7.2 - DN 7.8, galvanised steel, female

Art. No.	Type No.	Connection	Length mm	a/f mm
141549	244.550	G 1/8 IT	32.0	14
141550	244.551	G 1/4 IT	33.0	17
141551	244.552	G 3/8 IT	33.0	19
141552	244.553	G 1/2 IT	36.0	24



244.552

Plug for couplings DN 7.2 - DN 7.8, galvanised steel, for hose

Art. No.	Type No.	Connection	Length mm	a/f mm
141538	244.580	for hose 6x4	34.0	12
141539	244.581	for hose 8x6	33.0	14
141540	244.583	for hose 10x8	42.0	17
141541	244.585	for hose 12x9	42.0	14



244.581

Plugs for couplings DN 7.2 - DN 7.8

Galvanised steel



244.593

Plug for couplings DN 7.2 - DN 7.8, galvanised steel, for hose with kink protector spring

Art. No.	Type No.	Connection	Length mm	a/f mm
158818	244.590	for hose 6x4 with kink protector spring	111.0	12
141542	244.591	for hose 8x6 with kink protector spring	116.0	14
141543	244.592	for hose 10x8 with kink protector spring	140.0	19
141544	244.593	for hose 12x9 with kink protector spring	142.0	17



Quick disconnect couplings DN 7.8

»R16K« series, with high flow rates

MAX

One-hand quick disconnect couplings, one side sealing, that combine high flow rates (approx. twice as high as the popular DN 7.2 standard coupling) with minimal coupling forces.

Suitable for all applications with an above-average air requirement!

To prevent injuries or a "whiplash" effect, we recommend that the plug-in nipple is held with one hand during uncoupling.

These quick disconnect couplings are not suitable for direct attachment to pulsating tools. We recommend using our vibration dampers, according to ISO 6150 § 7.1.

Areas of application: Pneumatic system, machine and plant engineering, measurement, monitoring and control systems, manufacturing industry, medical technology, chemical / pharmaceutical industry, workshops, automotive, food technology, aerospace.

Operating pressure	0 - 35 bar
Medium temperature	-20 to 40 °C
Ambient temperature	-20 to 40 °C
Flow rate	2100 l/min (air)
Flow rate measurement	at 6 bar and $\Delta p = 0.5$ bar
Threaded piece	Nickel-plated brass
Valve body	Steel, QPQ treated
Unlocking sleeve	Extremely robust, ergonomic plastic
Valve	Brass
Valve seat	Brass
Spring	Stainless steel
Retaining ring	Stainless steel
Ball	Stainless steel
Sealant	NBR



241.11

Quick disconnect coupling DN 7.8 - for extremely high flow rates, male

Art. No.	Type No.	Connection	Length mm	a/f mm
107406	241.11	G 1/4 ET	65.0	19
107407	241.12	G 3/8 ET	65.0	19
107408	241.13	G 1/2 ET	59.0	22



241.21

Quick disconnect coupling DN 7.8 - for extremely high flow rates, female

Art. No.	Type No.	Connection	Length mm	a/f mm
107409	241.21	G 1/4 IT	59.0	19
107410	241.22	G 3/8 IT	59.0	19
107411	241.23	G 1/2 IT	62.0	24

Quick disconnect couplings DN 7.8

»R16K« series, with high flow rates

MAX |||



241.31

Quick disconnect coupling DN 7.8 - for extremely high flow rates, with hose stem

Art. No.	Type No.	Connection	Length mm	a/f mm
107412	241.31	I.D. 6	80.0	19
107413	241.32	I.D. 8	80.0	19
107414	241.33	I.D. 9	80.0	19
107415	241.34	I.D. 10	80.0	19
107416	241.35	I.D. 13	80.0	19

→ You can find vibration dampers on page 851

Stems for couplings DN 7.2 - DN 7.8

nickel-plated brass

Stem for couplings DN 7.2 - DN 7.8, nickel-plated brass

Art. No.	Type No.	Connection	Length mm
107300	243.06-N	I.D. 6	44.0
107301	243.351-N	I.D. 8	45.0
107302	243.07-N	I.D. 9	44.0
107303	243.352-N	I.D. 10	45.0
107304	243.10-N	I.D. 13	46.0



243.351-N

Plugs for couplings DN 7.2 - DN 7.8

nickel-plated brass

Plug for couplings DN 7.2 - DN 7.8, nickel-plated brass, male

Art. No.	Type No.	Connection	Length mm	a/f mm
107305	243.48-N	G 1/8 ET	31.0	14
107306	243.50-N	G 1/4 ET	32.0	17
107307	243.51-N	G 3/8 ET	33.0	19
107308	243.52-N	G 1/2 ET	35.0	24



243.50-N



Plug for couplings DN 7.2 - DN 7.8, nickel-plated brass, female

Art. No.	Type No.	Connection	Length mm	a/f mm
107309	243.54-N	G 1/8 IT	31.0	14
107310	243.55-N	G 1/4 IT	32.0	17
107311	243.56-N	G 3/8 IT	32.0	19
107312	243.57-N	G 1/2 IT	34.0	24



243.55-N

Plug for couplings DN 7.2 - DN 7.8, nickel-plated brass, for hose

Art. No.	Type No.	Connection	Length mm	a/f mm
107313	243.216-N	for hose 6x4	34.0	12
107314	243.217-N	for hose 8x6	34.0	14
107315	243.218-N	for hose 10x8	42.0	17



243.216-N

Plugs for couplings DN 7.2 - DN 7.8

nickel-plated brass



243.357-N

Plug for couplings DN 7.2 - DN 7.8, nickel-plated brass, for hose with swivel nut and kink protector spring

Art. No.	Type No.	Connection	Length mm	a/f mm
107316	243.355-N	for hose 6x4 with swivel nut and kink protector spring	112.0	
107317	243.356-N	for hose 8x6 with swivel nut and kink protector spring	120.0	14
107318	243.357-N	for hose 10x8 with swivel nut and kink protector spring	140.0	19
107319	243.358-N	for hose 12x9 with swivel nut and kink protector spring	120.0	19

Push-in elbow for couplings DN 7.2 - DN 7.8

nickel-plated brass



243.761

Push-in elbow for couplings DN 7.2 - DN 7.8, nickel-plated brass

Art. No.	Type No.	Connection	Width mm	Height mm
107254	243.761	for hose 8x6	48.0	27.0



Quick disconnect couplings DN 7.8

»R25ES« series

One-hand quick disconnect couplings, one side sealing, made of stainless steel 1.4305. To prevent injuries or a "whiplash" effect, we recommend that the plug-in nipple is held with one hand during uncoupling.

These quick disconnect couplings are not suitable for direct attachment to pulsating tools. We recommend using our vibration dampers, according to ISO 6150 § 7.1.

Areas of application: Pneumatic system, machine and plant engineering, manufacturing industry, medical technology, chemical / pharmaceutical industry, food technology, aerospace, mining, offshore.

Operating pressure	0 to 35 bar, maximum static working pressure (non-pulsating)
Medium temperature	-15 to 200 °C
Ambient temperature	-15 to 200 °C
Flow rate	1800 l/min (air)
Flow rate measurement	at 6 bar and $\Delta p = 0.5$ bar
Housing	Stainless steel 1.4305
Sleeve	Stainless steel 1.4305
Valve body	Stainless steel 1.4305
Spring	Stainless steel
Retaining ring	Stainless steel
Ball	Stainless steel
Sealant	FKM



243.50 B

Quick disconnect coupling DN 7.8, stainless steel 1.4305, male

Art. No.	Type No.	Connection	Length mm	a/f mm
107417	243.50 A	G 1/4 ET	59.5	19
107418	243.50 B	G 3/8 ET	57.5	19
107419	243.50 C	G 1/2 ET	60.5	24

Quick disconnect couplings DN 7.8

»R25ES« series



Quick disconnect coupling DN 7.8, stainless steel 1.4305, female				
Art. No.	Type No.	Connection	Length mm	a/f mm
107420	243.60 A	G 1/4 IT	55.5	19
107421	243.60 B	G 3/8 IT	54.5	19
107422	243.60 C	G 1/2 IT	57.5	24



243.60 B

Quick disconnect coupling DN 7.8, stainless steel 1.4305, with hose stem				
Art. No.	Type No.	Connection	Length mm	a/f mm
107423	243.70 A	I.D. 6	73.5	19
107424	243.70 B	I.D. 8	73.5	19
107425	243.70 C	I.D. 9	73.5	19
107426	243.70 D	I.D. 10	73.5	19
107427	243.70 E	I.D. 13	73.5	19



243.70 B

→ Vibration dampers on request 851

Stems for couplings DN 7.2 - DN 7.8

stainless steel 1.4305

Stem for couplings DN 7.2 - DN 7.8, stainless steel 1.4305				
Art. No.	Type No.	Connection	Type No.	Length mm
107428	243.80 A	I.D. 6		48.0
107429	243.80 B	I.D. 8		48.0
107430	243.80 C	I.D. 9		48.0
107431	243.80 D	I.D. 10		48.0
107432	243.80 E	I.D. 13		48.0



243.80 C

Plugs for couplings DN 7.2 - DN 7.8

stainless steel 1.4305

Plug for couplings DN 7.2 - DN 7.8, stainless steel 1.4305, male				
Art. No.	Type No.	Connection	Length mm	a/f mm
107433	243.85 A	G 1/8 ET	31.0	14
107434	243.85 B	G 1/4 ET	33.0	17
107435	243.85 C	G 3/8 ET	33.0	19
107436	243.85 D	G 1/2 ET	38.0	24



243.85 C

Plug for couplings DN 7.2 - DN 7.8, stainless steel 1.4305, female				
Art. No.	Type No.	Connection	Length mm	a/f mm
107437	243.95 A	G 1/8 IT	30.0	14
107438	243.95 B	G 1/4 IT	33.0	17
107439	243.95 C	G 3/8 IT	33.0	19
107440	243.95 D	G 1/2 IT	35.0	24



243.95 C



Compressed air distributor system

Type »Multi-Link«

MAX

Modular distributor system for flexible workplace design, can be rotated 180°. Equipped for 2 to 5 bleed units, optionally with:

- G 1/2 female threaded connection for individually adaption output segments
- DN 7.6 quick disconnect safety couplings



VTM-1



VTM-1KS



ZS-12



ZS-KS

Max. operating pressure	16 bar
Material	Galvanised steel / brass
Sealant	NBR
Connecting thread	G 1/2 female
Medium	Compressed air, non-corrosive gases

Compressed air distributor, type »Multi-Link« without couplings, female thread

Art. No.	Type No.	Temperature range °C	Connection	Bleed units
107388	VTM-1	-20 to 100	G 1/2 IT	1
107389	VTM-2	-20 to 100	G 1/2 IT	2
107390	VTM-3	-20 to 100	G 1/2 IT	3
107391	VTM-4	-20 to 100	G 1/2 IT	4
107392	VTM-5	-20 to 100	G 1/2 IT	5

Compressed air distributor, type »Multi-Link« with quick disconnect safety couplings DN 7.6

Art. No.	Type No.	Temperature range °C	Connection	Bleed units
107398	VTM-1KS	-20 to 80	Safety couplings DN 7.6	1
107399	VTM-2KS	-20 to 80	Safety couplings DN 7.6	2
107400	VTM-3KS	-20 to 80	Safety couplings DN 7.6	3
107401	VTM-4KS	-20 to 80	Safety couplings DN 7.6	4
107402	VTM-5KS	-20 to 80	Safety couplings DN 7.6	5

Between segment, type »Multi-Link«

Art. No.	Type No.	Temperature range °C	Connection	Bleed units
107403	ZS-12	-20 to 100	Segment G 1/2	1
107405	ZS-KS	-20 to 80	Segment safety couplings DN 7.6	1

→ You can find the product descriptions of the quick disconnect safety couplings DN 7.6 on page 519

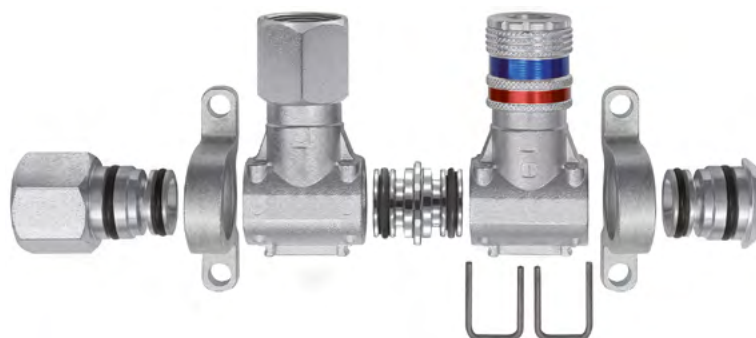

Installation Example



VTM-2



VTM-3



VTM-4



VTM-5

Quick disconnect couplings DN 10

»R27MSV« series, with high flow rates



PLUS

One-hand quick disconnect couplings, one side sealing, that combine high flow rates (approx. 3.5 times as high as the popular DN 7.2 standard coupling) with minimal coupling forces.

Suitable for all applications with an above-average air requirement!

To prevent injuries or a "whiplash" effect, we recommend that the plug-in nipple is held with one hand during uncoupling.

These quick disconnect couplings are not suitable for direct attachment to pulsating tools. We recommend using our vibration dampers, according to ISO 6150 § 7.1.

Areas of application: Pneumatic system, Machine and plant engineering, Measurement, monitoring and control systems, manufacturing industry, medical technology, chemical / pharmaceutical industry, workshops, automotive, food technology, aerospace.

Operating pressure	0 - 35 bar
Medium temperature	-20 to 100 °C
Ambient temperature	-20 to 100 °C
Flow rate	3600 l/min (air)
Flow rate measurement	at 6 bar and $\Delta p = 0.5$ bar
Threaded piece	Nickel-plated brass
Valve body	Steel, QPQ treated
Unlocking sleeve	Nickel-plated brass
Valve	Brass
Valve seat	Brass
Spring	Stainless steel
Retaining ring	Stainless steel
Ball	Stainless steel
Sealant	NBR

Quick disconnect coupling DN 10 - for extremely high flow rates, male

Art. No.	Type No.	Connection	Length mm	a/f mm
107441	241.42	R 3/8 ET	69.7	24
107442	241.43	R 1/2 ET	74.7	24
107443	241.44	R 3/4 ET	63.7	27



241.42

Quick disconnect coupling DN 10 - for extremely high flow rates, female

Art. No.	Type No.	Connection	Length mm	a/f mm
107444	241.52	G 3/8 IT	67.7	24
107445	241.53	G 1/2 IT	67.6	24
107446	241.54	G 3/4 IT	73.7	32



241.52



Quick disconnect coupling DN 10 - for extremely high flow rates, with hose stem

Art. No.	Type No.	Connection	Length mm	a/f mm
107447	241.64	I.D. 10	79.7	24
107448	241.65	I.D. 13	79.7	24
107449	241.66	I.D. 16	79.7	24



241.65

→ You can find hose security cables on page 851

→ You can find vibration dampers on page 851

Stems for couplings DN 10

hardened, nickel-plated steel



T 243/9

Stem for couplings DN 10, hardened, nickel-plated steel

Art. No.	Type No.	Connection	Length mm
107450	T 243/6	I.D. 6	48.0
107451	T 243/8	I.D. 8	48.0
107452	T 243/9	I.D. 9	48.0
107453	T 243/10	I.D. 10	48.0
107454	T 243/13	I.D. 13	48.0
107455	T 243/16	I.D. 16	49.0
107456	T 243/19	I.D. 19	49.0

Plugs for couplings DN 10

hardened, nickel-plated steel



N 243/2

Plug for couplings DN 10, hardened, nickel-plated steel, male PTFE coated

Art. No.	Type No.	Connection	Length mm	a/f mm
107457	N 243/1	R 1/4 ET	40.0	17
107458	N 243/2	R 3/8 ET	40.0	17
107459	N 243/3	R 1/2 ET	45.0	22
107460	N 243/4	R 3/4 ET	48.0	27



N 243/7

Plug for couplings DN 10, hardened, nickel-plated steel, female

Art. No.	Type No.	Connection	Length mm	a/f mm
107461	N 243/6	G 1/4 IT	33.0	17
107462	N 243/7	G 3/8 IT	33.0	19
107463	N 243/8	G 1/2 IT	37.0	24
107464	N 243/9	G 3/4 IT	42.0	32

Quick disconnect couplings DN 10

»R27EMSV« series



PLUS

Single-sided blocking and robust quick connect coupling with high flow performance. To prevent injuries or a "whiplash" effect, we recommend that the plug-in nipple is held with one hand during uncoupling.

These quick disconnect couplings are not suitable for direct attachment to pulsating tools. We recommend using our vibration dampers, according to ISO 6150 § 7.1.

Areas of application: Pneumatic system, Machine and plant engineering, Measurement, monitoring and control systems, manufacturing industry, medical technology, chemical / pharmaceutical industry, workshops, automotive, food technology, aerospace.

Operating pressure	0 - 35 bar
Medium temperature	-20 to 100 °C
Ambient temperature	-20 to 100 °C
Flow rate	3500 l/min (air)
Flow rate measurement	at 6 bar and $\Delta p = 0.5$ bar
Housing	Nickel-plated brass
Valve	Nickel-plated brass
Spring	Stainless steel
Sleeve	Galvanised steel
Threaded piece	Nickel-plated brass
Sealant	NBR

Quick disconnect coupling DN 10, steel / nickel-plated brass, male

Art. No.	Type No.	Connection	Length mm	a/f mm
141553	241.42-E	R 3/8 ET	65.0	24
141554	241.43-E	R 1/2 ET	65.0	24
141555	241.44-E	R 3/4 ET	65.0	27



241.42-E

Quick disconnect coupling DN 10, steel / nickel-plated brass, female

Art. No.	Type No.	Connection	Length mm	a/f mm
141556	241.52-E	G 3/8 IT	59.0	24
141557	241.53-E	G 1/2 IT	62.0	24
141558	241.54-E	G 3/4 IT	66.0	30



241.52-E

Quick disconnect coupling DN 10, steel / nickel-plated brass, with hose stem

Art. No.	Type No.	Connection	Length mm	a/f mm
141559	241.64-E	I.D. 10	75.0	24
141560	241.65-E	I.D. 13	75.0	24
142168	241.66-E	I.D. 16	75.0	24



241.64-E



- You can find hose security cables on page 851
- You can find vibration dampers on page 851
- Stems and plugs see page 508



Quick disconnect couplings DN 12

»R12MS« series, for garages

PLUS

One-hand quick disconnect couplings, one side sealing, for high flow rates.
With rubber ring to protect against wear.

To prevent injuries or a "whiplash" effect, we recommend that the plug-in nipple is held with one hand during uncoupling.

These quick disconnect couplings are not suitable for direct attachment to pulsating tools.
We recommend using our vibration dampers, according to ISO 6150 § 7.1.

Areas of application: Machine and plant engineering, manufacturing industry, workshops.

Max. operating pressure	16 bar
Medium temperature	-10 to 50 °C
Ambient temperature	-10 to 50 °C
Flow rate	4150 l/min (air)
Flow rate measurement	at 6 bar and $\Delta p = 0.5$ bar
Material	Brass with a bare metal surface
Spring	Stainless steel
Sealant	NBR



243.60

Quick disconnect coupling DN 12, brass with a bare metal surface, male

Art. No.	Type No.	Connection	Length mm	a/f mm
107477	243.60	G 1/2 ET	82.0	30
107478	243.61	G 3/4 ET	82.0	30



243.65

Quick disconnect coupling DN 12, brass with a bare metal surface, female

Art. No.	Type No.	Connection	Length mm	a/f mm
107479	243.65	G 1/2 IT	82.0	30
107480	243.66	G 3/4 IT	82.0	30

→ You can find hose security cables on page 851

→ You can find vibration dampers on page 851

Stems for couplings DN 12

brass with a bare metal surface



243.68

Stem for couplings DN 12, brass with a bare metal surface

Art. No.	Type No.	Connection	Length mm
107481	243.68	I.D. 13	87.0
107482	243.69	I.D. 16	87.0
107483	243.70	I.D. 19	87.0

Plugs for couplings DN 12

brass with a bare metal surface

Plug for couplings DN 12, brass with a bare metal surface, male

Art. No.	Type No.	Connection	Length mm	a/f mm
107490	243.84	G 1/4 ET	54.0	17
107491	243.85	G 1/2 ET	63.0	20



243.84





Quick disconnect couplings DN 19

»R39MS« series

PLUS

Single-sided blocking and quick connect coupling with extremely high flow performance. To prevent injuries or a "whiplash" effect, we recommend that the plug-in nipple is held with one hand during uncoupling.

These quick disconnect couplings are not suitable for direct attachment to pulsating tools. We recommend using our vibration dampers, according to ISO 6150 § 7.1.

Areas of application: Machine and plant engineering, manufacturing industry, workshops.

Operating pressure	0 - 35 bar
Medium temperature	-20 to 100 °C
Ambient temperature	-20 to 100 °C
Flow rate	8700 l/min (air)
Flow rate measurement	at 6 bar and $\Delta p = 0.5$ bar
Housing	Brass with a bare metal surface
Valve	Brass with a bare metal surface
Spring	Stainless steel
Sleeve	Brass with a bare metal surface
Threaded piece	Brass with a bare metal surface
Sealant	NBR



419.15

Quick disconnect coupling DN 19, brass with a bare metal surface, male

Art. No.	Type No.	Connection	Length mm	a/f mm
141561	419.14	G 3/4 ET	95.0	41
141562	419.15	G 1 ET	98.0	41
141563	419.16	G 1 1/4 ET	98.0	42



419.05

Quick disconnect coupling DN 19, brass with a bare metal surface, female

Art. No.	Type No.	Connection	Length mm	a/f mm
141564	419.04	G 3/4 IT	98.0	41
141565	419.05	G 1 IT	100.0	41
141566	419.06	G 1 1/4 IT	102.0	50



419.27

Quick disconnect coupling DN 19, brass with a bare metal surface, with hose stem

Art. No.	Type No.	Connection	Length mm	a/f mm
141567	419.26	I.D. 16	114.0	41
141568	419.27	I.D. 19	114.0	41
141569	419.28	I.D. 25	114.0	41

→ You can find hose security cables on page 851

→ You can find vibration dampers on page 851

Stems for couplings DN 19

brass with a bare metal surface



419.78

Stem for couplings DN 19, brass with a bare metal surface

Art. No.	Type No.	Connection	Length mm
141576	419.76	I.D. 16	75.0
141577	419.77	I.D. 19	75.0
142170	419.78	I.D. 25	75.0

Plugs for couplings DN 19

brass with a bare metal surface

Plug for couplings DN 19, brass with a bare metal surface, male

Art. No.	Type No.	Connection	Length mm	a/f mm
141570	419.64	G 3/4 ET	60.0	30
141571	419.65	G 1 ET	65.0	35
141572	419.66	G 1 1/4 ET	68.0	46



419.65

Plug for couplings DN 19, brass with a bare metal surface, female

Art. No.	Type No.	Connection	Length mm	a/f mm
141573	419.54	G 3/4 IT	58.0	32
141574	419.55	G 1 IT	68.0	41
141575	419.56	G 1 1/4 IT	70.0	50



419.56





Quick disconnect couplings DN 5

»R21BA« series, both sides sealing

PLUS

Both the coupling and the self-sealing plug are fitted with a valve.

Connection: Both valves open and the medium is allowed to pass.

Disconnection: Both valves close and the medium is prevented from escaping.

Areas of application: Pneumatic system, machine and plant engineering, Measurement, monitoring and control systems, Manufacturing industry, medical technology, chemical / pharmaceutical industry, automotive, food technology, aerospace.

Operating pressure	0 to 35 bar, maximum static working pressure (non-pulsating)
Medium temperature	-20 to 100 °C
Ambient temperature	-20 to 100 °C
Flow rate	310 l/min (air)
Flow rate measurement	at 6 bar and $\Delta p = 0.5$ bar
Housing	Brass with a bare metal surface
Sleeve	Brass with a bare metal surface
Valve body	Brass with a bare metal surface
Spring	Stainless steel
Retaining ring	Stainless steel
Ball	Stainless steel
Sealant	NBR



243.18-B

Quick disconnect coupling DN 5, both sides sealing, brass with a bare metal surface, male

Art. No.	Type No.	Connection	Length mm	a/f mm
107492	243.18-B	G 1/8 ET	36.5	14
107493	243.19-B	G 1/4 ET	38.0	17



243.20-B

Quick disconnect coupling DN 5, both sides sealing, brass with a bare metal surface, female

Art. No.	Type No.	Connection	Length mm	a/f mm
107494	243.20-B	G 1/8 IT	38.0	14
107495	243.21-B	G 1/4 IT	38.0	17



243.26/S-B

Quick disconnect coupling DN 5, both sides sealing, brass with a bare metal surface, with hose stem

Art. No.	Type No.	Connection	Length mm
107496	243.25-B	I.D. 4	46.5
107497	243.26/S-B	I.D. 6	46.5
107498	243.26/9-B	I.D. 9	46.5

Stems for couplings DN 5

brass with a bare metal surface, both sides sealing



243.17-B

Stem for couplings DN 5, both sides sealing, brass with a bare metal surface

Art. No.	Type No.	Connection	Length mm	a/f mm
107499	243.16-B	I.D. 4	50.0	14
107500	243.17-B	I.D. 6	50.0	14
107501	243.17/S-B	I.D. 9	50.0	14

Plugs for couplings DN 5

brass with a bare metal surface, both sides sealing

Plug for couplings DN 5, both sides sealing, brass with a bare metal surface, male

Art. No.	Type No.	Connection	Length mm	a/f mm
107502	243.031-B	G 1/8 ET	40.0	14
107503	243.032-B	G 1/4 ET	42.0	17



243.032-B

Plug for couplings DN 5, both sides sealing, brass with a bare metal surface, female

Art. No.	Type No.	Connection	Length mm	a/f mm
107504	243.033-B	G 1/8 IT	42.0	14
107505	243.034-B	G 1/4 IT	42.0	17



243.034-B

Quick disconnect couplings DN 7.2

»R26BA« series, both sides sealing

PLUS

Couplings, stems and plugs are fitted with a valve.
 Connection: Both valves open and the medium is allowed to pass.
 Disconnection: Both valves close and the medium is prevented from escaping.

Areas of application: Pneumatic system, machine and plant engineering, Measurement, monitoring and control systems, Manufacturing industry, medical technology, chemical / pharmaceutical industry, automotive, food technology, aerospace.



Operating pressure	0 to 35 bar, maximum static working pressure (non-pulsating)
Medium temperature	-20 to 100 °C
Ambient temperature	-20 to 100 °C
Flow rate	700 l/min (air)
Flow rate measurement	at 6 bar and $\Delta p = 0.5$ bar
Housing	Brass with a bare metal surface
Sleeve	Brass with a bare metal surface
Valve body	Brass with a bare metal surface
Spring	Stainless steel
Retaining ring	Stainless steel
Ball	Stainless steel
Sealant	NBR

Quick disconnect coupling DN 7.2, both sides sealing, brass with a bare metal surface, male

Art. No.	Type No.	Connection	Length mm	a/f mm
107506	243.01-B	G 1/4 ET	40.0	22
107507	243.02-B	G 3/8 ET	41.0	22
107508	243.03-B	G 1/2 ET	41.0	24



243.01-B

Quick disconnect coupling DN 7.2, both sides sealing, brass with a bare metal surface, female

Art. No.	Type No.	Connection	Length mm	a/f mm
107509	243.11-B	G 1/4 IT	41.0	22
107510	243.22-B	G 3/8 IT	41.0	22
107511	243.33-B	G 1/2 IT	42.5	24



243.33-B





Quick disconnect couplings DN 7.2

»R26BA« series, both sides sealing

PLUS



243.45-B

Quick disconnect coupling DN 7.2, both sides sealing, brass with a bare metal surface, with hose stem

Art. No.	Type No.	Connection	Length mm	a/f mm
107512	243.44-B	I.D. 6	58.5	22
107513	243.47-B	I.D. 8	58.5	22
107514	243.45-B	I.D. 9	58.5	22
107515	243.49-B	I.D. 10	58.5	22
107516	243.46-B	I.D. 13	58.5	22

Stems for couplings DN 7.2 - DN 7.8

brass with a bare metal surface, both sides sealing



243.07-B

Stem for couplings DN 7.2 - DN 7.8, both sides sealing, brass with a bare metal surface

Art. No.	Type No.	Connection	Length mm
107517	243.06-B	I.D. 6	61.5
107518	243.351-B	I.D. 8	61.5
107519	243.07-B	I.D. 9	61.5
107520	243.352-B	I.D. 10	61.5
107521	243.10-B	I.D. 13	61.5

Plugs for couplings DN 7.2 - DN 7.8

brass with a bare metal surface, both sides sealing



243.50-B

Plug for couplings DN 7.2 - DN 7.8, both sides sealing, brass with a bare metal surface, male

Art. No.	Type No.	Connection	Length mm	a/f mm
107522	243.48-B	G 1/8 ET	41.0	22
107523	243.50-B	G 1/4 ET	43.0	22
107524	243.51-B	G 3/8 ET	44.0	22
107525	243.52-B	G 1/2 ET	44.0	24



243.55-B

Plug for couplings DN 7.2 - DN 7.8, both sides sealing, brass with a bare metal surface, female

Art. No.	Type No.	Connection	Length mm	a/f mm
107526	243.54-B	G 1/8 IT	42.0	22
107527	243.55-B	G 1/4 IT	44.0	22
107528	243.56-B	G 3/8 IT	44.0	22
107529	243.57-B	G 1/2 IT	45.5	24

Safety couplings DN 7.4

»R26K« series, KE type



EASY

One-hand air relief couplings with double locking system.

Connection: Similar to standard couplings, simply by pressing the plug into the coupling.

Disconnection: The first locking mechanism is accessible when the sleeve is pushed back. The coupling valve closes. Air can then be relieved from the plug side and inside the hose. The second locking mechanism is released by actuating the sleeve again. The coupling can now be disconnected safely.

This system meets the requirements of ISO 4414 and is BIA-compliant (BIA = industrial safety institute).

These safety couplings are not suitable for direct attachment to pulsating tools.

We recommend using our vibration dampers, according to ISO 6150 § 7.1.

Areas of application: Pneumatic system, machine and plant engineering, manufacturing industry, workshops, automotive.

Operating pressure	12 bar, maximum static working pressure (non-pulsating)
Medium temperature	-20 to 60 °C
Ambient temperature	-20 to 60 °C
Flow rate	1300 l/min (air)
Flow rate measurement	at 6 bar and $\Delta p = 0.5$ bar
Housing	Nickel-plated brass
Valve body	Nickel-plated brass
Valve	Brass
Unlocking sleeve	Plastic
Spring	Stainless steel
Retaining ring	Stainless steel
Pin	Stainless steel
Ball	Stainless steel
Sealant	NBR

Safety coupling DN 7.4, male

Art. No.	Type No.	Connection	Length mm	a/f mm
107554	249.61	G 1/4 ET	55.4	22
107555	249.62	G 3/8 ET	55.4	22
107556	249.63	G 1/2 ET	58.3	24



249.62

Safety coupling DN 7.4, female

Art. No.	Type No.	Connection	Length mm	a/f mm
107557	249.71	G 1/4 IT	57.2	22
107558	249.72	G 3/8 IT	60.2	24
107559	249.73	G 1/2 IT	60.2	24



249.72

Safety coupling DN 7.4, with hose stem

Art. No.	Type No.	Connection	Length mm	a/f mm
107560	249.81	I.D. 6	71.2	22
107561	249.82	I.D. 8	71.2	22
107562	249.83	I.D. 9	71.2	22
107563	249.84	I.D. 10	71.2	22
107564	249.85	I.D. 13	71.2	22



249.81

→ You can find vibration dampers on page 851

Stems for couplings DN 7.2 - DN 7.8

hardened, galvanised steel



243.06 ST

Stem for couplings DN 7.2 - DN 7.8, hardened, galvanised steel

Art. No.	Type No.	Connection	Length mm
107541	243.06 ST	I.D. 6	48.0
107542	243.06 ST-8	I.D. 8	48.0
107543	243.07 ST	I.D. 9	48.0
107544	243.07 ST-10	I.D. 10	48.0
107545	243.10 ST	I.D. 13	48.0

Plugs for couplings DN 7.2 - DN 7.8

hardened, galvanised steel



243.50 ST

Plug for couplings DN 7.2 - DN 7.8, hardened, galvanised steel, male

Art. No.	Type No.	Connection	Length mm	a/f mm
107546	243.49 ST	G 1/8 ET	33.0	13
107547	243.50 ST	G 1/4 ET	32.0	17
107548	243.51 ST	G 3/8 ET	34.0	19
107549	243.52 ST	G 1/2 ET	38.0	24



243.55 ST

Plug for couplings DN 7.2 - DN 7.8, hardened, galvanised steel, female

Art. No.	Type No.	Connection	Length mm	a/f mm
107550	243.54 ST	G 1/8 IT	30.0	14
107551	243.55 ST	G 1/4 IT	39.0	17
107552	243.56 ST	G 3/8 IT	40.0	19
107553	243.57 ST	G 1/2 IT	44.0	24

Safety couplings DN 7.6

»R320ST« series

MAX

High-quality, robust and durable, one-hand quick disconnect safety couplings, with very high flow rates and only a small pressure drop.

The coupling is released fully automatically in two steps. Air is relieved from the coupling before it is completely disconnected. The plug is only disconnected from the coupling if the residual pressure has dropped below 0.3 bar. The dreaded "whiplash effect" is thus avoided and the risk of injury virtually eliminated.

This safety version conforms to ISO-Standard DIN EN ISO 4414.

These safety couplings are not suitable for direct attachment to pulsating tools. We recommend using our vibration dampers, according to ISO 6150 § 7.1.

Areas of application: Pneumatic system, machine and plant engineering, manufacturing industry, workshops, automotive, mining.



Max. operating pressure	16 bar
Medium temperature	-20 to 100 °C
Ambient temperature	-20 to 100 °C
Flow rate	2250 l/min (air)
Flow rate measurement	at 6 bar and $\Delta p = 0.5$ bar
Material	Steel / zinc-plated brass
Spring	Stainless steel
Sealant	NBR

Safety coupling DN 7.6, male

Art. No.	Type No.	Connection	Length mm	a/f mm
107589	416.14-A	R 1/4 ET	63.0	20
107590	416.38-A	R 3/8 ET	61.0	20
107591	416.12-A	R 1/2 ET	55.5	22



416.14-A

Safety coupling DN 7.6, female

Art. No.	Type No.	Connection	Length mm	a/f mm
107592	416.14-I	G 1/4 IT	57.1	20
107593	416.38-I	G 3/8 IT	60.1	22
107594	416.12-I	G 1/2 IT	59.5	25



416.38-I

Safety coupling DN 7.6, with hose stem

Art. No.	Type No.	Connection	Length mm
107595	416.06-T	I.D. 6	67.0
107596	416.08-T	I.D. 8	69.5
107597	416.09-T	I.D. 9	70.1
107598	416.10-T	I.D. 10	70.0
107599	416.13-T	I.D. 13	68.0



416.10-T

Safety coupling DN 7.6 »stream line«

Art. No.	Type No.	For hose mm	Length mm	a/f 1 mm	a/f 2 mm
107600	416.06-SL	10x6.5	64.1	16	20
107601	416.08-SL	12x8	68.1	19	20
107602	416.09-SL	13.5x9.5	68.2	21	20
107603	416.11-SL	16x11	68.1	24	24



416.08-SL

→ You can find vibration dampers on page 851

Stems for couplings DN 7.2 - DN 7.8

hardened, galvanised steel



244.908

Stem for couplings DN 7.2 - DN 7.8, hardened and galvanised steel

Art. No.	Type No.	Connection	Length mm
107371	244.907	I.D. 6	42.0
107372	244.908	I.D. 8	45.0
107373	244.908-9	I.D. 9	45.0
107374	244.908-10	I.D. 10	45.0
107375	244.909	I.D. 13	45.0

Plugs for couplings DN 7.2 - DN 7.8

hardened, galvanised steel



244.902

Plug for couplings DN 7.2 - DN 7.8, hardened and galvanised steel, male, PTFE coated

Art. No.	Type No.	Connection	Length mm	a/f mm
107376	244.900	R 1/8 ET	35.0	13
107377	244.901	R 1/4 ET	39.0	14
107378	244.902	R 3/8 ET	41.0	17
107379	244.903	R 1/2 ET	47.0	22



244.905

Plug for couplings DN 7.2 - DN 7.8, hardened and galvanised steel, female

Art. No.	Type No.	Connection	Length mm	a/f mm
107380	244.904-1	G 1/8 IT	31.0	13
107381	244.904	G 1/4 IT	36.0	17
107382	244.905	G 3/8 IT	38.0	20
107383	244.906	G 1/2 IT	42.0	27



244.917

Plug for couplings DN 7.2 - DN 7.8, hardened and galvanised steel, »stream line«

Art. No.	Type No.	Connection	Length mm	a/f mm
107384	244.914	for hose 10x6.5	44.0	16
107385	244.915	for hose 12x8	47.0	19
107386	244.916	for hose 13.5x9.5	50.0	21
107387	244.917	for hose 16x11	56.0	24

Safety couplings DN 7.8

SEK type

EASY

One-hand safety coupling with double locking mechanism.

Connection: Similar to standard couplings, simply by pressing the plug into the coupling. Disconnection: The first locking mechanism is accessible when the sleeve is pushed back. The coupling valve closes. Air can then be relieved from the plug side (hose). The second locking mechanism is released by actuating the unlocking sleeve again. The coupling can now be disconnected.



Operating pressure	0 to 35 bar, maximum static working pressure (non-pulsating)
Medium temperature	-10 to 60 °C
Ambient temperature	-10 to 60 °C
Flow rate	1100 l/min (air)
Flow rate measurement	at 6 bar and $\Delta p = 0.5$ bar
Housing	Nickel-plated brass
Sleeve	Nickel-plated brass
Valve body	Nickel-plated brass
Spring	Stainless steel
Ball	Stainless steel
Sealant	NBR

Safety coupling DN 7.8, male				
Art. No.	Type No.	Connection	Length mm	a/f mm
107530	249.92	G 1/4 ET	44.0	22
107531	249.93	G 3/8 ET	44.0	22
107532	249.94	G 1/2 ET	47.0	24



249.94

Safety coupling DN 7.8, female				
Art. No.	Type No.	Connection	Length mm	a/f mm
107533	249.96	G 1/4 IT	46.0	22
107534	249.97	G 3/8 IT	46.0	22
107535	249.98	G 1/2 IT	49.0	24



249.98

Safety coupling DN 7.8, with hose stem				
Art. No.	Type No.	Connection	Length mm	a/f mm
107536	249.101	I.D. 6	60.0	22
107537	249.102	I.D. 8	60.0	22
107538	249.103	I.D. 9	60.0	22
107539	249.104	I.D. 10	60.0	22
107540	249.105	I.D. 13	60.0	22



249.103

→ You can find vibration dampers on page 851

Stems for couplings DN 7.2 - DN 7.8

hardened, galvanised steel

Stem for couplings DN 7.2 - DN 7.8, hardened, galvanised steel				
Art. No.	Type No.	Connection	Length mm	
107541	243.06 ST	I.D. 6	48.0	
107542	243.06 ST-8	I.D. 8	48.0	
107543	243.07 ST	I.D. 9	48.0	
107544	243.07 ST-10	I.D. 10	48.0	
107545	243.10 ST	I.D. 13	48.0	



243.06 ST



Plugs for couplings DN 7.2 - DN 7.8

hardened, galvanised steel



243.50 ST



243.55 ST

Plug for couplings DN 7.2 - DN 7.8, hardened, galvanised steel, male

Art. No.	Type No.	Connection	Length mm	a/f mm
107546	243.49 ST	G 1/8 ET	33.0	13
107547	243.50 ST	G 1/4 ET	32.0	17
107548	243.51 ST	G 3/8 ET	34.0	19
107549	243.52 ST	G 1/2 ET	38.0	24

Plug for couplings DN 7.2 - DN 7.8, hardened, galvanised steel, female

Art. No.	Type No.	Connection	Length mm	a/f mm
107550	243.54 ST	G 1/8 IT	30.0	14
107551	243.55 ST	G 1/4 IT	39.0	17
107552	243.56 ST	G 3/8 IT	40.0	19
107553	243.57 ST	G 1/2 IT	44.0	24

Safety couplings DN 7.8

»R125MSV« series, Bi-Tec type



MAX II

Safety air relief couplings for gaseous media.
Combination of a sliding valve and a quick disconnect coupling.

Connection is pressureless. Only a low spring force has to be overcome. Pressure only builds up when the green sleeve is pushed forward. It is impossible to disconnect the hose either intentionally or inadvertently in this position. When the sliding sleeve is moved back into its home position, the air is relieved from the hose and the coupling can be disconnected.

These safety couplings are not suitable for direct attachment to pulsating tools.
We recommend using our vibration dampers, according to ISO 6150 § 7.1.

Areas of application: Pneumatic system, machine and plant engineering, manufacturing industry, workshops, automotive.

Max. operating pressure	20 bar
Medium temperature	-20 to 100 °C
Ambient temperature	-20 to 100 °C
Flow rate	2050 l/min (air)
Flow rate measurement	at 6 bar and $\Delta p = 0.5$ bar
Housing	Nickel-plated brass
Valve body	Nickel-plated brass
Unlocking sleeve	Hardened, nickel-plated steel
Sleeve	Anodised aluminium
Spring	Stainless steel
Ball	Stainless steel
Sealant	NBR



249.04-S

Safety coupling DN 7.8, male

Art. No.	Type No.	Connection	Length mm	a/f mm
134074	249.04-S	R 1/4 ET	80.0	19
134075	249.05-S	R 3/8 ET	81.0	19
134076	249.07-S	R 1/2 ET	87.0	22

Safety couplings DN 7.8

»R125MSV« series, Bi-Tec type

MAX |||



249.14-S



249.26-S

Safety coupling DN 7.8, female

Art. No.	Type No.	Connection	Length mm	a/f mm
134077	249.14-S	G 1/4 IT	75.0	19
134078	249.15-S	G 3/8 IT	75.0	19
134079	249.16-S	G 1/2 IT	80.0	24

Safety coupling DN 7.8, with hose stem

Art. No.	Type No.	Connection	Length mm
134080	249.24-S	I.D. 6	84.5
134081	249.25-S	I.D. 8	84.5
134082	249.26-S	I.D. 9	84.5
134083	249.27-S	I.D. 10	84.5
134084	249.28-S	I.D. 13	84.5

→ You can find vibration dampers on page 851

Stems for couplings DN 7.2 - DN 7.8

nickel-plated brass

Stem for couplings DN 7.2 - DN 7.8, nickel-plated brass

Art. No.	Type No.	Connection	Length mm
107300	243.06-N	I.D. 6	44.0
107301	243.351-N	I.D. 8	45.0
107302	243.07-N	I.D. 9	44.0
107303	243.352-N	I.D. 10	45.0
107304	243.10-N	I.D. 13	46.0



243.351-N

Plugs for couplings DN 7.2 - DN 7.8

nickel-plated brass

Plug for couplings DN 7.2 - DN 7.8, nickel-plated brass, male

Art. No.	Type No.	Connection	Length mm	a/f mm
107305	243.48-N	G 1/8 ET	31.0	14
107306	243.50-N	G 1/4 ET	32.0	17
107307	243.51-N	G 3/8 ET	33.0	19
107308	243.52-N	G 1/2 ET	35.0	24



243.50-N

Plug for couplings DN 7.2 - DN 7.8, nickel-plated brass, female

Art. No.	Type No.	Connection	Length mm	a/f mm
107309	243.54-N	G 1/8 IT	31.0	14
107310	243.55-N	G 1/4 IT	32.0	17
107311	243.56-N	G 3/8 IT	32.0	19
107312	243.57-N	G 1/2 IT	34.0	24



243.55-N



Plugs for couplings DN 7.2 - DN 7.8

nickel-plated brass



243.216-N

Plug for couplings DN 7.2 - DN 7.8, nickel-plated brass, for hose

Art. No.	Type No.	Connection	Length mm	a/f mm
107313	243.216-N	for hose 6x4	34.0	12
107314	243.217-N	for hose 8x6	34.0	14
107315	243.218-N	for hose 10x8	42.0	17



243.357-N

Plug for couplings DN 7.2 - DN 7.8, nickel-plated brass, for hose with swivel nut and kink protector spring

Art. No.	Type No.	Connection	Length mm	a/f mm
107316	243.355-N	for hose 6x4 with swivel nut and kink protector spring	112.0	
107317	243.356-N	for hose 8x6 with swivel nut and kink protector spring	120.0	14
107318	243.357-N	for hose 10x8 with swivel nut and kink protector spring	140.0	19
107319	243.358-N	for hose 12x9 with swivel nut and kink protector spring	120.0	19

Push-in elbow for couplings DN 7.2 - DN 7.8

nickel-plated brass



243.761

Push-in elbow for couplings DN 7.2 - DN 7.8, nickel-plated brass

Art. No.	Type No.	Connection	Width mm	Height mm
107254	243.761	for hose 8x6	48.0	27.0

Safety couplings DN 10

»R410ST« series

MAX

High-quality, robust and durable, one-hand quick disconnect safety couplings, with very high flow rate and only a small pressure drop.

The coupling is released fully automatically in two steps. Air is relieved from the coupling before it is completely disconnected. The plug is only disconnected from the coupling if the residual pressure has dropped below 0.3 bar. The dreaded "whiplash effect" is thus avoided and the risk of injury virtually eliminated.

Suitable for all applications with an above-average air consumption and characterised by extreme conditions.

This safety version conforms to ISO-Standard DIN EN ISO 4414.

These safety couplings are not suitable for direct attachment to pulsating tools. We recommend using our vibration dampers, according to ISO 6150 § 7.1.

Areas of application: Pneumatic system, machine and plant engineering, manufacturing industry, workshops, automotive, mining.



Max. operating pressure	16 bar
Medium temperature	-20 to 100 °C
Ambient temperature	-20 to 100 °C
Flow rate	4000 l/min (air)
Flow rate measurement	at 6 bar and $\Delta p = 0.5$ bar
Material	Steel / zinc-plated brass
Spring	Stainless steel
Sealant	NBR

Safety coupling DN 10, male

Art. No.	Type No.	Connection	Length mm	a/f mm
107615	411.38-A	R 3/8 ET	68.0	24
107616	411.12-A	R 1/2 ET	70.3	24
107617	411.34-A	R 3/4 ET	60.8	27



411.34-A

Safety coupling DN 10, female

Art. No.	Type No.	Connection	Length mm	a/f mm
107618	411.38-I	G 3/8 IT	62.3	24
107619	411.12-I	G 1/2 IT	67.3	25
107620	411.34-I	G 3/4 IT	64.5	32



411.38-I

Safety coupling DN 10, with hose stem

Art. No.	Type No.	Connection	Length mm	a/f mm
107621	411.10-T	I.D. 10	77.0	24
107622	411.13-T	I.D. 13	75.3	24
107623	411.16-T	I.D. 16	75.3	24
107624	411.19-T	I.D. 19	74.3	24



411.13-T

→ You can find vibration dampers on page 851



Stems for couplings DN 10

hardened, galvanised steel, robust type



410.92

Stem for couplings DN 10, hardened, galvanised steel, robust type

Art. No.	Type No.	Connection	Length mm
107471	410.91	I.D. 10	46.0

Stem for couplings DN 10, hardened, galvanised steel, robust type

Art. No.	Type No.	Connection	Length mm
107472	410.92	I.D. 13	45.0

Plugs for couplings DN 10

hardened, galvanised steel, robust type



410.93

Plug for couplings DN 10, hardened, galvanised steel, robust type, male

Art. No.	Type No.	Connection	Length mm	a/f mm
107473	410.93	R 3/8 ET	41.0	17
107474	410.94	R 1/2 ET	48.0	22



410.95

Plug for couplings DN 10, hardened, galvanised steel, robust type, female

Art. No.	Type No.	Connection	Length mm	a/f mm
107475	410.95	G 3/8 IT	38.0	20
107476	410.96	G 1/2 IT	44.0	27

Pushbutton safety couplings DN 5.5, acc. ARO 210

»R244AAL« series, swivel type

EASY

High-quality, robust and durable, one-hand quick disconnect safety couplings. When it is pressed for the first time, air is relieved from the coupling but the plug in the coupling remains locked. The plug is only disconnected when the pushbutton is pressed for the second time. The dreaded "whiplash effect" is avoided and the risk of injury to the operator virtually eliminated.

The safety version conforms to ISO-Standard DIN EN ISO 4414.

Areas of application: Pneumatic system, machine and plant engineering, measurement, monitoring and control systems, manufacturing industry, workshops, automotive.



Max. operating pressure	12 bar
Medium temperature	-20 to 70 °C
Ambient temperature	-20 to 70 °C
Flow rate	1080 l/min (air)
Flow rate measurement	at 6 bar and $\Delta p = 1$ bar
Housing	Anodised aluminium
Pushbutton	Hardened, galvanised steel
Valve	Hardened, galvanised steel
Internal parts	Stainless steel 1.4404
Threaded piece	Nickel-plated brass
Sealant	NBR
Plug profile	acc. ARO 210

Pushbutton safety coupling DN 5.5, acc. ARO 210, male, swivel type

Art. No.	Type No.	Connection	Length mm	a/f mm
134054	244.11-D-A	G 1/4 ET	75.0	21
134055	244.12-D-A	G 3/8 ET	75.0	21
134056	244.13-D-A	G 1/2 ET	77.5	25



244.11-D-A

Pushbutton safety coupling DN 5.5, acc. ARO 210, female, swivel type

Art. No.	Type No.	Connection	Length mm	a/f mm
134057	244.21-D-A	G 1/4 IT	78.5	21
134058	244.22-D-A	G 3/8 IT	80.5	21
134059	244.23-D-A	G 1/2 IT	82.5	24



244.21-D-A

Pushbutton safety coupling DN 5.5, acc. ARO 210, with hose stem, swivel type

Art. No.	Type No.	Connection	Length mm	a/f mm
134060	244.31-D-A	I.D. 6	93.5	21
134061	244.32-D-A	I.D. 9	93.5	21
134062	244.33-D-A	I.D. 13	93.5	21



244.32-D-A



Stems for couplings DN 5.5, ARO 210

hardened, galvanised steel

Stem for couplings DN 5.5, ARO 210, hardened, galvanised steel

Art. No.	Type No.	Connection	Length mm
134063	243.06-A-ST	I.D. 6	50.0
134064	243.07-A-ST	I.D. 9	50.0
134065	243.10-A-ST	I.D. 13	50.0



243.07-A-ST

Plugs for couplings DN 5.5, ARO 210

hardened, galvanised steel



243.51-A-ST

Plug for couplings DN 5.5, ARO 210, hardened, galvanised steel, male

Art. No.	Type No.	Connection	Length mm	a/f mm
134066	243.49-A-ST	G 1/8 ET	38.0	13
134067	243.50-A-ST	G 1/4 ET	42.0	14
134068	243.51-A-ST	G 3/8 ET	43.0	17
134069	243.52-A-ST	G 1/2 ET	43.0	22
140095	243.60-A-ST	R 1/8 ET	41.0	13
140096	243.61-A-ST	R 1/4 ET	44.0	14
140099	243.62-A-ST	R 3/8 ET	44.0	17
140100	243.63-A-ST	R 1/2 ET	48.0	22



243.56-A-ST

Plug for couplings DN 5.5, ARO 210, hardened, galvanised steel, female

Art. No.	Type No.	Connection	Length mm	a/f mm
134070	243.54-A-ST	G 1/8 IT	34.0	14
134071	243.55-A-ST	G 1/4 IT	36.0	17
134072	243.56-A-ST	G 3/8 IT	36.0	19
134073	243.57-A-ST	G 1/2 IT	40.0	24



Pushbutton safety couplings DN 6, acc. ISO 6150 C

»R1075.06« series

PLUS

High quality, robust and long-lifetime quick connect coupling in a safety design that can be operated with one hand.

When pushed for the first time the coupling is vented, the plug remains securely in the coupling.

After a second push the plug is released.

This prevents a potential "whiplash effect" and the risk of operating personnel is practically excluded.

The safety version meets ISO standard DIN EN ISO 4414.

Areas of application: Pneumatic system, machine and plant engineering, measurement, monitoring and control systems, manufacturing industry, workshops, automotive, mining, offshore.

Max. operating pressure	12 bar
Temperature range	-20 to 200 °C
Flow rate	1150 l/min (air)
Flow rate measurement	at 6 bar and $\Delta p = 1$ bar
Housing	Stainless steel
Pushbutton	Stainless steel
Valve	Brass
Spring	Stainless steel
Threaded piece	Galvanised steel
Sealant	FKM
Plug profile	acc. ISO 6150 C



406.13-ES

Pushbutton safety coupling DN 6, acc. ISO 6150 C, male

Art. No.	Type No.	Connection	Length mm	a/f mm
141930	406.11-ES	G 1/8 ET	52.0	20
141931	406.12-ES	G 1/4 ET	54.0	20
141932	406.13-ES	G 3/8 ET	54.0	20
141933	406.14-ES	G 1/2 ET	58.0	22

Pushbutton safety couplings DN 6, acc. ISO 6150 C

»R1075.06« series

PLUS ||



Pushbutton safety coupling DN 6, acc. ISO 6150 C, female

Art. No.	Type No.	Connection	Length mm	a/f mm
141926	406.01-ES	G 1/8 IT	53.0	20
141927	406.02-ES	G 1/4 IT	55.0	20
141928	406.03-ES	G 3/8 IT	55.0	20
141929	406.04-ES	G 1/2 IT	58.0	24



406.01-ES

Pushbutton safety coupling DN 6, acc. ISO 6150 C, with hose stem

Art. No.	Type No.	Connection	Length mm	a/f mm
141934	406.21-ES	I.D. 6	71.0	20
141935	406.22-ES	I.D. 8	71.0	20
141936	406.24-ES	I.D. 10	71.0	20
141937	406.25-ES	I.D. 13	71.0	20



406.22-ES

Pushbutton safety coupling DN 6, acc. ISO 6150 C, with hose connector

Art. No.	Type No.	Connection	Length mm	a/f mm
141938	406.31-ES	Hose connection 8x6	62.0	20
141939	406.33-ES	Hose connection 10x8	62.0	20



406.33-ES

Stems for couplings DN 6, ISO 6150 C

Stainless steel

Stem for couplings DN 6, ISO 6150 C, stainless steel

Art. No.	Type No.	Connection	Length mm
141948	406.71-ES	I.D. 6	62.0
141949	406.72-ES	I.D. 8	62.0
141950	406.74-ES	I.D. 10	62.0
141951	406.75-ES	I.D. 13	62.0



406.75-ES

Plugs for couplings DN 6, ISO 6150 C

Stainless steel

Plug for couplings DN 6, ISO 6150 C, stainless steel, male

Art. No.	Type No.	Connection	Length mm	a/f mm
141944	406.60-ES	G 1/8 ET	44.0	14
141945	406.61-ES	G 1/4 ET	48.0	14
141946	406.62-ES	G 3/8 ET	52.0	17
141947	406.63-ES	G 1/2 ET	55.0	22



406.63-ES

Plug for couplings DN 6, ISO 6150 C, stainless steel, female

Art. No.	Type No.	Connection	Length mm	a/f mm
141940	406.50-ES	G 1/8 IT	44.0	13
141941	406.51-ES	G 1/4 IT	50.0	17
141942	406.52-ES	G 3/8 IT	52.0	22
141943	406.53-ES	G 1/2 IT	54.0	27



406.53-ES





NEW Pushbutton safety couplings DN 7.4, DKSK

»DKSK« series, swivel type

MAX

High-quality, robust and durable, one-hand quick disconnect safety couplings. When it is pressed for the first time, air is relieved from the coupling but the plug in the coupling remains locked. The plug is only disconnected when the pushbutton is pressed for the second time. The dreaded "whiplash effect" is avoided and the risk of injury to the operator virtually eliminated.

The safety version conforms to ISO-Standard DIN EN ISO 4414.

These safety couplings are not suitable for direct attachment to pulsating tools. We recommend using our vibration dampers, according to ISO 6150 § 7.1. Areas of application: Pneumatic system, machine and plant engineering, manufacturing industry, workshops, automotive.

Max. operating pressure	12 bar
Medium temperature	-20 to 70 °C
Ambient temperature	-20 to 70 °C
Flow rate	1600 l/min (air)
Flow rate measurement	at 6 bar and $\Delta p = 1$ bar
Housing	Anodised aluminium
Pushbutton	Hardened, galvanised steel
Valve	Hardened, galvanised steel
Internal parts	Stainless steel 1.4310
Threaded piece	Nickel-plated brass
Sealant	NBR



DKSKAG14

Pushbutton safety coupling DN 7.4, male, swivel type

Art. No.	Type No.	Connection	Length mm	a/f mm
199982	DKSKAG14	G 1/4 ET	71.3	21
199983	DKSKAG38	G 3/8 ET	71.3	21
205560	DKSKAG12	G 1/2 ET	73.3	24



DKSKIG14

Pushbutton safety coupling DN 7.4, female, swivel type

Art. No.	Type No.	Connection	Length mm	a/f mm
199979	DKSKIG14	G 1/4 IT	71.3	21
199980	DKSKIG38	G 3/8 IT	72.3	21
199981	DKSKIG12	G 1/2 IT	74.3	24



DKSKLW6

Pushbutton safety coupling DN 7.4, with hose stem, swivel type

Art. No.	Type No.	Connection	Length mm	a/f mm
199985	DKSKLW6	I.D. 6	86.6	21
199986	DKSKLW8	I.D. 8	86.6	21
199987	DKSKLW9	I.D. 9	86.6	21
199988	DKSKLW10	I.D. 10	86.6	21
199989	DKSKLW13	I.D. 13	86.6	21

Stems for couplings DN 7.2 - DN 7.8

hardened, galvanised steel

Stem for couplings DN 7.2 - DN 7.8, hardened, galvanised steel

Art. No.	Type No.	Connection	Length mm
107541	243.06 ST	I.D. 6	48.0
107542	243.06 ST-8	I.D. 8	48.0
107543	243.07 ST	I.D. 9	48.0
107544	243.07 ST-10	I.D. 10	48.0
107545	243.10 ST	I.D. 13	48.0



243.06 ST

Plugs for couplings DN 7.2 - DN 7.8

hardened, galvanised steel

Plug for couplings DN 7.2 - DN 7.8, hardened, galvanised steel, male

Art. No.	Type No.	Connection	Length mm	a/f mm
107546	243.49 ST	G 1/8 ET	33.0	13
107547	243.50 ST	G 1/4 ET	32.0	17
107548	243.51 ST	G 3/8 ET	34.0	19
107549	243.52 ST	G 1/2 ET	38.0	24



243.50 ST

Plug for couplings DN 7.2 - DN 7.8, hardened, galvanised steel, female

Art. No.	Type No.	Connection	Length mm	a/f mm
107550	243.54 ST	G 1/8 IT	30.0	14
107551	243.55 ST	G 1/4 IT	39.0	17
107552	243.56 ST	G 3/8 IT	40.0	19
107553	243.57 ST	G 1/2 IT	44.0	24



243.55 ST





5

Distributor socket

plastic, with pushbutton-type safety couplings DN 7.4

MAX

2 or 3-way distributor sockets made of high-strength glass fibre-reinforced plastic (PA6 GF 30) for a wide range of applications. All distributor sockets have a durable brass threaded insert, whose shape secures it against rotation and against axial shift due to its shape. Drilling diagram dimensions are identical for all distributor sockets, so a simpler and more flexible exchange replacement. Caution: Note that the distributor sockets should not be installed in danger zones. Danger zones are, for example, transport routes, escape routes, etc.

Max. operating pressure	12 bar
Operating temperature in air	-10 to 50 °C
Operating temperature in water	1 to 50 °C
Housing	Glass fibre-reinforced plastic PA6 GF 30
Thread material	Brass
Max. tightening torque brass thread	12 Nm
Max. tightening torque mounting holes	4 Nm



EVDS12-2

End distributor socket without through-hole thread, with pushbutton-type safety couplings DN 7.4

Art. No.	Type No.	Inlet thread	Coupling	Width mm	Height mm
107576	EVDS12-2	G 1/2	2 x Safety coupling	156.0	59.0
107577	EVDS12-3	G 1/2	3 x Safety coupling	156.0	59.0
107578	EVDS34-2	G 3/4	2 x Safety coupling	156.0	59.0
107579	EVDS34-3	G 3/4	3 x Safety coupling	156.0	59.0



EVDS12-3

Universal junction socket, with 2 safety couplings I.D. 7.4

Art. No.	Type No.	Inlet thread	Coupling	Width mm	Height mm
205213	UVDS12-2	G 1/2	2 x Safety coupling	86.0	60.0



UVDS12-2

Pushbutton safety couplings DN 7.4

»R244ES« series, swivel type

High-quality, robust and durable, one-hand quick disconnect safety couplings.

When it is pressed for the first time, air is relieved from the coupling but the plug in the coupling remains locked. The plug is only disconnected when the pushbutton is pressed for the second time. The dreaded "whiplash effect" is avoided and the risk of injury to the operator virtually eliminated.

The safety version conforms to ISO-Standard DIN EN ISO 4414.

These safety couplings are not suitable for direct attachment to pulsating tools. We recommend using our vibration dampers, according to ISO 6150 § 7.1.

Areas of application: Pneumatic system, machine and plant engineering, manufacturing industry, medical technology, chemical / pharmaceutical industry, workshops, automotive.



Max. operating pressure	12 bar
Medium temperature	-20 to 150 °C
Ambient temperature	-20 to 150 °C
Flow rate	1600 l/min (air)
Flow rate measurement	at 6 bar and $\Delta p = 1$ bar
Housing	Stainless steel 1.4404
Pushbutton	Stainless steel 1.4404
Valve	Stainless steel 1.4404
Internal parts	Stainless steel 1.4404
Threaded piece	Stainless steel 1.4404
Sealant	FKM

Pushbutton safety coupling DN 7.4, stainless steel 1.4404, male, swivel type

Art. No.	Type No.	Connection	Length mm	a/f mm
107580	244.11-DES	G 1/4 ET	70.0	21
107581	244.12-DES	G 3/8 ET	70.0	21
107582	244.13-DES	G 1/2 ET	72.5	25



244.11-DES

Pushbutton safety coupling DN 7.4, stainless steel 1.4404, female, swivel type

Art. No.	Type No.	Connection	Length mm	a/f mm
107583	244.21-DES	G 1/4 IT	73.5	21
107584	244.22-DES	G 3/8 IT	75.5	21
107585	244.23-DES	G 1/2 IT	77.5	24



244.21-DES

Pushbutton safety coupling DN 7.4, stainless steel 1.4404, with hose stem, swivel type

Art. No.	Type No.	Connection	Length mm	a/f mm
107586	244.31-DES	I.D. 6	88.5	21
107587	244.32-DES	I.D. 9	88.5	21
107588	244.33-DES	I.D. 13	88.5	21



244.32-DES



→ Vibration dampers on request 851

Stems for couplings DN 7.2 - DN 7.8

stainless steel 1.4305



243.80 C

Stem for couplings DN 7.2 - DN 7.8, stainless steel 1.4305

Art. No.	Type No.	Connection	Length mm
107428	243.80 A	I.D. 6	48.0
107429	243.80 B	I.D. 8	48.0
107430	243.80 C	I.D. 9	48.0
107431	243.80 D	I.D. 10	48.0
107432	243.80 E	I.D. 13	48.0

Plugs for couplings DN 7.2 - DN 7.8

stainless steel 1.4305



243.85 C

Plug for couplings DN 7.2 - DN 7.8, stainless steel 1.4305, male

Art. No.	Type No.	Connection	Length mm	a/f mm
107433	243.85 A	G 1/8 ET	31.0	14
107434	243.85 B	G 1/4 ET	33.0	17
107435	243.85 C	G 3/8 ET	33.0	19
107436	243.85 D	G 1/2 ET	38.0	24



243.95 C

Plug for couplings DN 7.2 - DN 7.8, stainless steel 1.4305, female

Art. No.	Type No.	Connection	Length mm	a/f mm
107437	243.95 A	G 1/8 IT	30.0	14
107438	243.95 B	G 1/4 IT	33.0	17
107439	243.95 C	G 3/8 IT	33.0	19
107440	243.95 D	G 1/2 IT	35.0	24

Pushbutton safety couplings DN 8, acc. ISO 6150 C

»R1075.08« series



PLUS

High quality, robust and long-lifetime quick connect coupling in a safety design that can be operated with one hand.

When pushed for the first time the coupling is vented, the plug remains securely in the coupling.

After a second push the plug is released.

This prevents a potential "whiplash effect" and the risk of operating personnel is practically excluded.

The safety version meets ISO standard DIN EN ISO 4414.

These safety couplings are not suitable for direct attachment to pulsating tools.

We recommend using our vibration dampers, according to ISO 6150 § 7.1.

Areas of application: Pneumatic system, machine and plant engineering, measurement, monitoring and control systems, manufacturing industry, workshops, automotive, mining, offshore.

Max. operating pressure	16 bar
Temperature range	-20 to 200 °C
Flow rate	2080 l/min (air)
Flow rate measurement	at 6 bar and $\Delta p = 1$ bar
Housing	Stainless steel
Pushbutton	Stainless steel
Valve	Brass
Spring	Stainless steel
Threaded piece	Galvanised steel
Sealant	FKM
Plug profile	acc. ISO 6150 C

Pushbutton safety coupling DN 8, acc. ISO 6150 C, male

Art. No.	Type No.	Connection	Length mm	a/f mm
141955	408.12-ES	G 1/4 ET	72.0	25
141956	408.13-ES	G 3/8 ET	72.0	25
141957	408.14-ES	G 1/2 ET	75.0	25



408.14-ES

Pushbutton safety coupling DN 8, acc. ISO 6150 C, female

Art. No.	Type No.	Connection	Length mm	a/f mm
141952	408.02-ES	G 1/4 IT	66.0	25
141953	408.03-ES	G 3/8 IT	66.0	25
141954	408.04-ES	G 1/2 IT	71.0	25

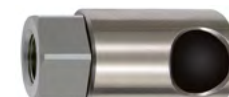

408.03-ES

Pushbutton safety coupling DN 8, acc. ISO 6150 C, with hose stem

Art. No.	Type No.	Connection	Length mm	a/f mm
141958	408.22-ES	I.D. 8	86.0	25
141959	408.23-ES	I.D. 9	86.0	25
141960	408.24-ES	I.D. 10	86.0	25
141961	408.25-ES	I.D. 13	86.0	25
141962	408.26-ES	I.D. 16	86.0	25



408.25-ES

Pushbutton safety coupling DN 8, acc. ISO 6150 C, with hose connector

Art. No.	Type No.	Connection	Length mm	a/f mm
141963	408.33-ES	Hose connection 10x8	78.0	25
141964	408.36-ES	Hose connection 12x10	78.0	25



408.33-ES

→ You can find vibration dampers on page 851

Stems for couplings DN 8, ISO 6150 C

Stainless steel



408.72-ES

Stem for couplings DN 8, ISO 6150 C, stainless steel

Art. No.	Type No.	Connection	Length mm
141973	408.72-ES	I.D. 8	66.0
141974	408.74-ES	I.D. 10	66.0
141975	408.75-ES	I.D. 13	74.0
141976	408.76-ES	I.D. 16	74.0

Plugs for couplings DN 8, ISO 6150 C

Stainless steel



408.63-ES

Plug for couplings DN 8, ISO 6150 C, stainless steel, male

Art. No.	Type No.	Connection	Length mm	a/f mm
141969	408.60-ES	G 1/8 ET	53.0	15
141970	408.61-ES	G 1/4 ET	55.0	17
141971	408.62-ES	G 3/8 ET	55.0	19
141972	408.63-ES	G 1/2 ET	60.0	24



408.52-ES

Plug for couplings DN 8, ISO 6150 C, stainless steel, female

Art. No.	Type No.	Connection	Length mm	a/f mm
141965	408.50-ES	G 1/8 IT	50.0	15
141966	408.51-ES	G 1/4 IT	55.0	17
141967	408.52-ES	G 3/8 IT	55.0	22
141968	408.53-ES	G 1/2 IT	59.0	27

Pushbutton safety couplings DN 11, acc. ISO 6150 C

»R107S.11« series



PLUS

High quality, robust and long-lifetime quick connect coupling in a safety design that can be operated with one hand.

When pushed for the first time the coupling is vented, the plug remains securely in the coupling.

After a second push the plug is released.

This prevents a potential "whiplash effect" and the risk of operating personnel is practically excluded.

The safety version meets ISO standard DIN EN ISO 4414.

These safety couplings are not suitable for direct attachment to pulsating tools.

We recommend using our vibration dampers, according to ISO 6150 § 7.1.

Areas of application: Pneumatic system, machine and plant engineering, manufacturing industry, mining, offshore.

Max. operating pressure	16 bar
Temperature range	-20 to 200 °C
Flow rate	4500 l/min (air)
Flow rate measurement	at 6 bar and $\Delta p = 1$ bar
Housing	Stainless steel
Pushbutton	Stainless steel
Valve	Brass
Spring	Stainless steel
Threaded piece	Galvanised steel
Sealant	FKM
Plug profile	acc. ISO 6150 C

Pushbutton safety coupling DN 11, acc. ISO 6150 C, male

Art. No.	Type No.	Connection	Length mm	a/f mm
141980	411.12-ES	G 3/8 ET	84.0	30
141981	411.13-ES	G 1/2 ET	87.0	30
141982	411.14-ES	G 3/4 ET	90.0	30



411.14-ES

Pushbutton safety coupling DN 11, acc. ISO 6150 C, female

Art. No.	Type No.	Connection	Length mm	a/f mm
141977	411.02-ES	G 3/8 IT	73.0	30
141978	411.03-ES	G 1/2 IT	76.0	30
141979	411.04-ES	G 3/4 IT	81.0	30



411.04-ES

Pushbutton safety coupling DN 11, acc. ISO 6150 C, with hose stem

Art. No.	Type No.	Connection	Length mm	a/f mm
141983	411.22-ES	I.D. 8	101.0	30
141984	411.24-ES	I.D. 10	101.0	30
141985	411.25-ES	I.D. 13	107.0	30
141986	411.26-ES	I.D. 16	107.0	30
141987	411.27-ES	I.D. 19	107.0	30



411.25-ES

→ You can find vibration dampers on page 851



Stems for couplings DN 11, ISO 6150 C

Stainless steel



411.75-ES

Stem for couplings DN 11, ISO 6150 C, stainless steel

Art. No.	Type No.	Connection	Length mm
141994	411.72-ES	I.D. 8	73.0
141995	411.74-ES	I.D. 10	73.0
141996	411.75-ES	I.D. 13	78.0
141997	411.76-ES	I.D. 16	78.0
141998	411.77-ES	I.D. 19	78.0

Plugs for couplings DN 11, ISO 6150 C

Stainless steel



411.63-ES

Plug for couplings DN 11, ISO 6150 C, stainless steel, male

Art. No.	Type No.	Connection	Length mm	a/f mm
141991	411.62-ES	G 3/8 ET	65.0	22
141992	411.63-ES	G 1/2 ET	68.0	24
141993	411.64-ES	G 3/4 ET	70.0	30



411.53-ES

Plug for couplings DN 11, ISO 6150 C, stainless steel, female

Art. No.	Type No.	Connection	Length mm	a/f mm
141988	411.52-ES	G 3/8 IT	61.0	22
141989	411.53-ES	G 1/2 IT	65.0	27
141990	411.54-ES	G 3/4 IT	65.0	32

Swivel safety couplings DN 6, acc. ISO 6150 C

»R-SV1« series, 2-stage

PLUS

High quality, robust and long lifetime one-hand rotation secure coupling. A secure connection is made by pushing in the plug-in nipple that clicks in audibly. Uncoupling is done by rotating the sleeve anti-clockwise. For this, the pending pressure in the coupling and line are vented, however the plug-in nipple is not completely released via a safety latch. The plug-in nipple can only be pulled out after a clockwise rotation of the sleeve.

This coupling meets ISO standard DIN EN ISO 4414, EN 983.

Areas of application: Pneumatic system, machine and plant engineering, measurement, monitoring and control systems, manufacturing industry, workshops, automotive, mining.



Operating pressure	max. 25 bar / max. 16 bar when attaching / detaching
Temperature range	-20 to 100 °C
Flow rate	630 l/min (air)
Flow rate measurement	at 6 bar and $\Delta p = 0.5$ bar
Medium	Compressed air, gases
Housing	Steel, QPQ treated
Valve	Polyphenylene sulfide (PPS)
Spring	Stainless steel
Sleeve	Polyamide, red
Threaded piece	Galvanised steel
Sealant	NBR
Plug profile	acc. ISO 6150 C

Swivel safety coupling DN 6, acc. ISO 6150 C, male

Art. No.	Type No.	Connection	Length mm	a/f mm
141740	423.11-DREH	G 1/4 ET	58.0	22
141741	423.12-DREH	G 3/8 ET	58.0	22
141742	423.13-DREH	G 1/2 ET	59.0	22



423.12-DREH

Swivel safety coupling DN 6, acc. ISO 6150 C, female

Art. No.	Type No.	Connection	Length mm	a/f mm
141736	423.00-DREH	G 1/8 IT	48.0	22
141737	423.01-DREH	G 1/4 IT	51.0	22
141738	423.02-DREH	G 3/8 IT	60.0	22
141739	423.03-DREH	G 1/2 IT	62.0	24



423.01-DREH

Swivel safety coupling DN 6, acc. ISO 6150 C, with hose stem

Art. No.	Type No.	Connection	Length mm	a/f mm
141743	423.21-DREH	I.D. 6	70.0	22
141744	423.22-DREH	I.D. 8	70.0	22
141745	423.24-DREH	I.D. 10	70.0	22
141746	423.25-DREH	I.D. 13	70.0	22



423.25-DREH



→ Other types can be found online

Stems for couplings DN 6, ISO 6150 C

Steel, QPQ treated



423.74

Stem for couplings DN 6, ISO 6150 C, steel, QPQ treated

Art. No.	Type No.	Connection	Length mm
141647	423.71	I.D. 6	55.0
141648	423.72	I.D. 8	55.0
141649	423.74	I.D. 10	55.0
141650	423.75	I.D. 13	55.0

Plugs for couplings DN 6, ISO 6150 C

Steel, QPQ treated

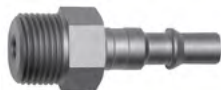

423.62

Plug for couplings DN 6, ISO 6150 C, steel, QPQ treated, male

Art. No.	Type No.	Connection	Length mm	a/f mm
141639	423.60	G 1/8 ET	46.0	14
141640	423.61	G 1/4 ET	46.0	14
141641	423.62	G 3/8 ET	49.0	17
141642	423.61-NPT	NPT 1/4 ET	50.0	14
141643	423.62-NPT	NPT 3/8 ET	53.0	17



423.51

Plug for couplings DN 6, ISO 6150 C, steel, QPQ treated, female

Art. No.	Type No.	Connection	Length mm	a/f mm
141644	423.50	G 1/8 IT	46.0	14
141645	423.51	G 1/4 IT	47.0	17
141646	423.51-NPT	NPT 1/4 IT	48.0	17

Swivel safety couplings DN 8, acc. ISO 6150 C

»R-SV2« series, 2-stage



PLUS

High quality, robust and long lifetime one-hand rotation secure coupling.
A secure connection is made by pushing in the plug-in nipple that clicks in audibly. Uncoupling is done by rotating the sleeve anti-clockwise. For this, the pending pressure in the coupling and line are vented, however the plug-in nipple is not completely released via a safety latch. The plug-in nipple can only be pulled out after a clockwise rotation of the sleeve.

This coupling meets ISO standard DIN EN ISO 4414, EN 983.

These safety couplings are not suitable for direct attachment to pulsating tools.
We recommend using our vibration dampers, according to ISO 6150 § 7.1.

Areas of application: Pneumatic system, machine and plant engineering, measurement, monitoring and control systems, manufacturing industry, workshops, automotive.

Operating pressure	max. 25 bar / max. 16 bar when attaching / detaching
Temperature range	-20 to 100 °C
Flow rate	1200 l/min (air)
Flow rate measurement	at 6 bar and $\Delta p = 0.5$ bar
Medium	Compressed air, gases
Housing	Steel, QPQ treated
Valve	Brass with a bare metal surface
Spring	Stainless steel
Sleeve	Polyamide, red
Threaded piece	Galvanised steel
Sealant	NBR
Plug profile	acc. ISO 6150 C

Swivel safety coupling DN 8, acc. ISO 6150 C, male

Art. No.	Type No.	Connection	Length mm	a/f mm
141759	425.12-DREH	G 3/8 ET	78.0	27
141760	425.13-DREH	G 1/2 ET	78.0	27



425.12-DREH

Swivel safety coupling DN 8, acc. ISO 6150 C, female

Art. No.	Type No.	Connection	Length mm	a/f mm
141756	425.01-DREH	G 1/4 IT	81.0	27
141757	425.02-DREH	G 3/8 IT	81.0	27
141758	425.03-DREH	G 1/2 IT	81.0	27



425.02-DREH

Swivel safety coupling DN 8, acc. ISO 6150 C, with hose stem

Art. No.	Type No.	Connection	Length mm	a/f mm
141761	425.22-DREH	I.D. 8	89.0	27
141762	425.24-DREH	I.D. 10	90.0	27
141763	425.25-DREH	I.D. 13	90.0	27



425.24-DREH

- Other types can be found online
- You can find vibration dampers on page 851



Stems for couplings DN 8, ISO 6150 C

Steel, QPQ treated



425.75

Stem for couplings DN 8, ISO 6150 C, steel, QPQ treated

Art. No.	Type No.	Connection	Length mm
141704	425.72	I.D. 8	63.0
141705	425.74	I.D. 10	63.0
141706	425.75	I.D. 13	63.0
141707	425.76	I.D. 16	63.0

Plugs for couplings DN 8, ISO 6150 C

Steel, QPQ treated



425.62

Plug for couplings DN 8, ISO 6150 C, steel, QPQ treated, male

Art. No.	Type No.	Connection	Length mm	a/f mm
141696	425.61	G 1/4 ET	56.0	17
141697	425.62	G 3/8 ET	56.0	19
141698	425.61-NPT	NPT 1/4 ET	59.0	17
141699	425.62-NPT	NPT 3/8 ET	59.0	19



425.51

Plug for couplings DN 8, ISO 6150 C, steel, QPQ treated, female

Art. No.	Type No.	Connection	Length mm	a/f mm
141700	425.51	G 1/4 IT	56.0	17
141701	425.52	G 3/8 IT	58.0	24
141702	425.51-NPT	NPT 1/4 IT	57.0	17
141703	425.52-NPT	NPT 3/8 IT	58.0	24

Stems with check valve for couplings DN 8, ISO 6150 C

hardened, galvanised steel, steel, QPQ treated



425.75-RSV

Stem with check valve for couplings DN 8, ISO 6150 C, hardened, galvanised steel, steel, QPQ treated

Art. No.	Type No.	Connection	Length mm
141774	425.74-RSV	I.D. 10	91.0
141775	425.75-RSV	I.D. 13	92.0

Plugs with check valve for couplings DN 8, ISO 6150 C

hardened, galvanised steel, steel, QPQ treated

Plug with check valve for couplings DN 8, ISO 6150 C, hardened, galvanised steel, steel, QPQ treated, male

Art. No.	Type No.	Connection	Length mm	a/f mm
141773	425.62-RSV	G 3/8 ET	79.0	19



425.62-RSV

Plug with check valve for couplings DN 8, ISO 6150 C, hardened, galvanised steel, steel, QPQ treated, female

Art. No.	Type No.	Connection	Length mm	a/f mm
141772	425.52-RSV	G 3/8 IT	81.0	22



425.52-RSV





Swing safety couplings DN 7.2

»R-SC/C« series

MAX

Swing safety coupling with free passage.

The plug-in nipple is inserted into the coupling body and rotated by an approx. 90° motion to make the connection. As soon as the "red ring" clicks into the intended slot then a secure connection has been made. To release the connection again, the "red ring" must be pulled out and the plug-in nipple is swivelled to the stopper into the starting position. Venting is done during uncoupling through a vent hole on the back side of the coupling.

This coupling meets ISO standard DIN EN ISO 4414, EN 983.

These safety couplings are not suitable for direct attachment to pulsating tools. We recommend using our vibration dampers, according to ISO 6150 § 7.1.

Areas of application: Pneumatic system, machine and plant engineering, measurement, monitoring and control systems, manufacturing industry, workshops, automotive.

Operating pressure	max. 25 bar / max. 16 bar when attaching / detaching
Temperature range	-20 to 100 °C
Flow rate	2300 l/min (air)
Flow rate measurement	at 6 bar and $\Delta p = 0.5$ bar
Medium	Compressed air, gases
Housing	Steel, QPQ treated
Sleeve	Die-cast zinc, nickel-plated, red rubber coated
Threaded piece	Galvanised steel
Sealant	NBR
Plug profile	EURO 7.2



424.11-SCH

Swing safety coupling DN 7.2, male

Art. No.	Type No.	Connection	Length mm	a/f mm
141657	424.11-SCH	G 1/4 ET	69.0	20
141658	424.12-SCH	G 3/8 ET	69.0	20
141659	424.13-SCH	G 1/2 ET	71.0	22
141660	424.11-SCH-NPT	NPT 1/4 ET	70.0	24
141661	424.12-SCH-NPT	NPT 3/8 ET	70.0	24
141662	424.13-SCH-NPT	NPT 1/2 ET	77.0	24



424.01-SCH

Swing safety coupling DN 7.2, female

Art. No.	Type No.	Connection	Length mm	a/f mm
141651	424.01-SCH	G 1/4 IT	69.0	20
141652	424.02-SCH	G 3/8 IT	69.0	20
141653	424.03-SCH	G 1/2 IT	70.0	24
141654	424.01-SCH-NPT	NPT 1/4 IT	69.0	20
141655	424.02-SCH-NPT	NPT 3/8 IT	69.0	20
141656	424.03-SCH-NPT	NPT 1/2 IT	74.0	24



424.22-SCH

Swing safety coupling DN 7.2, with hose stem

Art. No.	Type No.	Connection	Length mm	a/f mm
141663	424.22-SCH	I.D. 8	82.0	22
141664	424.24-SCH	I.D. 10	82.0	22
141665	424.25-SCH	I.D. 13	82.0	22



424.34-SCH

Swing safety coupling DN 7.2, with hose connector

Art. No.	Type No.	Connection	Length mm	a/f mm
141666	424.34-SCH	Hose connection 8x12	76.0	22
141667	424.35-SCH	Hose connection 11x16	81.0	24

- ➔ Other types can be found online
- ➔ You can find vibration dampers on page 851

Stems for couplings DN 7.2

hardened, galvanised steel

Stem for couplings DN 7.2, hardened, galvanised steel

Art. No.	Type No.	Connection	Length mm
141676	424.72	I.D. 8	50.0
141677	424.74	I.D. 10	50.0
141678	424.75	I.D. 13	50.0



424.74

Plugs for couplings DN 7.2

hardened, galvanised steel

Plug for couplings DN 7.2, hardened, galvanised steel, male

Art. No.	Type No.	Connection	Length mm	a/f mm
141668	424.61	G 1/4 ET	42.0	14
141669	424.62	G 3/8 ET	44.0	19
157163	424.63	G 1/2 ET	44.0	24
141670	424.61-NPT	NPT 1/4 ET	43.0	14
141671	424.62-NPT	NPT 3/8 ET	43.0	19



424.61

Plug for couplings DN 7.2, hardened, galvanised steel, female

Art. No.	Type No.	Connection	Length mm	a/f mm
141672	424.51	G 1/4 IT	42.0	17
141673	424.52	G 3/8 IT	43.0	19
159872	424.53	G 1/2 IT	48.0	27
141674	424.51-NPT	NPT 1/4 IT	42.0	17
141675	424.52-NPT	NPT 3/8 IT	43.0	21



424.52





5

Distributor socket

plastic, with swing safety couplings DN 7.2, »R-SC/C« series

MAX

2 or 3-way distributor sockets made of high-strength glass fibre-reinforced plastic (PA6 GF 30) for a wide range of applications. Available with 2 or 3 pre-assembled, swing safety couplings and 2 inlet thread sizes for input and output threads (Not combinable). All distributor sockets have a durable brass threaded insert, whose shape secures it against rotation and against axial shift due to its shape. Drilling diagram dimensions are identical for all distributor sockets, so a simpler and more flexible exchange replacement. Caution: Note that the distributor sockets should not be installed in danger zones. Danger zones are, for example, transport routes, escape routes, etc.

Max. operating pressure	12 bar
Housing	Glass fibre-reinforced plastic
Thread material	Brass
Max. tightening torque brass thread	12 Nm
Max. tightening torque mounting holes	4 Nm



EVDSCH12-2

End distributor socket without through-hole thread, with swing safety couplings DN 7.2

Art. No.	Type No.	Inlet thread	Coupling	Width mm	Height mm
142178	EVDSCH12-2	G 1/2	2 x swing safety coupling	165.0	59.0
142180	EVDSCH12-3	G 1/2	3 x swing safety coupling	165.0	59.0

Non-interchangeable quick disconnect couplings DN 5

»R21UV« series



PLUS

One-hand quick disconnect couplings with a large bore.
Different media can be connected safely and non-interchangeably even when space is restricted, thanks to the colour-coded coupling and plug and the different coupling profiles defined for each of the four colours.
Only couplings and plugs of the same colour fit together.

Areas of application: Pneumatic system, machine and plant engineering, measurement, monitoring and control systems, manufacturing industry, medical technology, chemical / pharmaceutical industry, automotive, food technology, aerospace.

Operating pressure	0 to 35 bar, maximum static working pressure (non-pulsating)
Medium temperature	-20 to 100 °C
Ambient temperature	-20 to 100 °C
Flow rate	560 l/min (air)
Flow rate measurement	at 6 bar and $\Delta p = 0.5$ bar
Housing	Brass with a bare metal surface
Valve	Brass with a bare metal surface
Unlocking sleeve	Anodised aluminium
Spring	Stainless steel
Retaining ring	Stainless steel
Ball	Stainless steel
Sealant	NBR

Non-interchangeable quick disconnect coupling DN 5, male

Art. No.	Type No.	Connection	Colour	Length mm	a/f mm
107625	247.01	G 1/8 ET	Green	45.0	14
107626	247.02	G 1/4 ET	Green	47.0	17
107629	247.11	G 1/8 ET	Brown	45.0	14
107630	247.12	G 1/4 ET	Brown	47.0	17
107633	247.21	G 1/8 ET	Blue	45.0	14
107634	247.22	G 1/4 ET	Blue	47.0	17
107637	247.31	G 1/8 ET	Red	45.0	14
107638	247.32	G 1/4 ET	Red	47.0	17



Non-interchangeable quick disconnect coupling DN 5, female

Art. No.	Type No.	Connection	Colour	Length mm	a/f mm
107627	247.03	G 1/8 IT	Green	45.0	14
107628	247.04	G 1/4 IT	Green	47.0	17
107631	247.13	G 1/8 IT	Brown	45.0	14
107632	247.14	G 1/4 IT	Brown	47.0	17
107635	247.23	G 1/8 IT	Blue	45.0	14
107636	247.24	G 1/4 IT	Blue	47.0	17
107639	247.33	G 1/8 IT	Red	45.0	14
107640	247.34	G 1/4 IT	Red	47.0	17



- Standard push-in plugs for couplings DN 5 and DN 7.2 – DN 7.8 are compatible with these non-interchangeable couplings.
- Length refers to the total length. For sketches see page 583-585



Non-interchangeable stems DN 5

Brass with a bare metal surface



247.52

Non-interchangeable stem DN 5, brass with a bare metal surface

Art. No.	Type No.	Connection	Colour	Length mm
107641	247.52	I.D. 6	Green	47.0
107642	247.54	I.D. 6	Brown	47.0
107643	247.56	I.D. 6	Blue	47.0
107644	247.58	I.D. 6	Red	47.0

Non-interchangeable plugs DN 5

Brass with a bare metal surface



247.61



247.66



247.71



247.76

Non-interchangeable plug DN 5, brass with a bare metal surface, male

Art. No.	Type No.	Connection	Colour	Length mm	a/f mm
107645	247.61	G 1/8 ET	Green	40.0	17
107646	247.62	G 1/4 ET	Green	42.0	17
107649	247.65	G 1/8 ET	Brown	40.0	17
107650	247.66	G 1/4 ET	Brown	42.0	17
107653	247.69	G 1/8 ET	Blue	40.0	17
107654	247.70	G 1/4 ET	Blue	42.0	17
107657	247.73	G 1/8 ET	Red	40.0	17
107658	247.74	G 1/4 ET	Red	42.0	17

Non-interchangeable plug DN 5, brass with a bare metal surface, female

Art. No.	Type No.	Connection	Colour	Length mm	a/f mm
107647	247.63	G 1/8 IT	Green	39.0	17
107648	247.64	G 1/4 IT	Green	39.0	17
107651	247.67	G 1/8 IT	Brown	39.0	17
107652	247.68	G 1/4 IT	Brown	39.0	17
107655	247.71	G 1/8 IT	Blue	39.0	17
107656	247.72	G 1/4 IT	Blue	39.0	17
107659	247.75	G 1/8 IT	Red	39.0	17
107660	247.76	G 1/4 IT	Red	39.0	17

Non-interchangeable quick disconnect couplings DN 7.8

»R26UV« series



PLUS

One-hand quick disconnect couplings with a large bore. Different media can be connected safely and non-interchangeably even when space is restricted, thanks to the colour-coded coupling and plug and the different coupling profiles defined for each of the four colours. Only couplings and plugs of the same colour fit together.

Areas of application: Pneumatic system, machine and plant engineering, measurement, monitoring and control systems, manufacturing industry, medical technology, chemical / pharmaceutical industry, automotive, food technology, aerospace.

Operating pressure	0 to 35 bar, maximum static working pressure (non-pulsating)
Medium temperature	-20 to 100 °C
Ambient temperature	-20 to 100 °C
Flow rate	1800 l/min (air)
Flow rate measurement	at 6 bar and $\Delta p_p = 0.5$ bar
Housing	Brass with a bare metal surface
Valve	Die-cast zinc, nickel-plated
Unlocking sleeve	Anodised aluminium
Spring	Stainless steel
Retaining ring	Stainless steel
Ball	Stainless steel
Sealant	NBR

Non-interchangeable quick disconnect coupling DN 7.8, male

Art. No.	Type No.	Connection	Colour	Length mm	a/f mm
107661	248.01	G 1/4 ET	Green	57.5	19
107662	248.02	G 3/8 ET	Green	57.5	19
107665	248.11	G 1/4 ET	Brown	57.5	19
107666	248.12	G 3/8 ET	Brown	57.5	19
107669	248.21	G 1/4 ET	Blue	57.5	19
107670	248.22	G 3/8 ET	Blue	57.5	19
107673	248.31	G 1/4 ET	Red	57.5	19
107674	248.32	G 3/8 ET	Red	57.5	19



248.01



248.12

Non-interchangeable quick disconnect coupling DN 7.8, female

Art. No.	Type No.	Connection	Colour	Length mm	a/f mm
107663	248.03	G 1/4 IT	Green	55.5	19
107664	248.04	G 3/8 IT	Green	54.5	19
107667	248.13	G 1/4 IT	Brown	55.5	19
107668	248.14	G 3/8 IT	Brown	54.5	19
107671	248.23	G 1/4 IT	Blue	55.5	19
107672	248.24	G 3/8 IT	Blue	54.5	19
107675	248.33	G 1/4 IT	Red	55.5	19
107676	248.34	G 3/8 IT	Red	54.5	19



248.24



248.33

→ Standard push-in plugs for couplings DN 5 and DN 7.2 – DN 7.8 are compatible with these non-interchangeable couplings.

→ Length refers to the total length. For sketches see page 583-585

Non-interchangeable stems DN 7.8

Brass with a bare metal surface



248.58

Non-interchangeable stem DN 7.8, brass with a bare metal surface

Art. No.	Type No.	Connection	Colour	Length mm
107677	248.51	I.D. 6	Green	51.0
107678	248.52	I.D. 9	Green	51.0
107679	248.53	I.D. 6	Brown	51.0
107680	248.54	I.D. 9	Brown	51.0
107681	248.55	I.D. 6	Blue	51.0
107682	248.56	I.D. 9	Blue	51.0
107683	248.57	I.D. 6	Red	51.0
107684	248.58	I.D. 9	Red	51.0

Non-interchangeable plugs DN 7.8

Brass with a bare metal surface



248.61



248.66

Non-interchangeable plug DN 7.8, brass with a bare metal surface, male

Art. No.	Type No.	Connection	Colour	Length mm	a/f mm
107685	248.61	G 1/4 ET	Green	37.0	17
107686	248.62	G 3/8 ET	Green	37.0	19
107687	248.65	G 1/4 ET	Brown	37.0	17
107688	248.66	G 3/8 ET	Brown	37.0	19
107689	248.69	G 1/4 ET	Blue	37.0	17
107690	248.70	G 3/8 ET	Blue	37.0	19
107691	248.73	G 1/4 ET	Red	37.0	17
107692	248.74	G 3/8 ET	Red	37.0	19

Hydraulic couplings

both sides sealing - brass with a bare metal surface



Hydraulic couplings, both sides sealing, for liquid media acc. to ISO 7241, B Series.

Areas of application: machine and plant engineering, manufacturing industry, chemical / pharmaceutical industry, automotive, food technology.



Operating pressure	Referred to medium temp. of 50 °C, static working pressure
Medium temperature	-20 to 100 °C
Ambient temperature	-20 to 100 °C
Flow rate measurement	at 6 bar and $\Delta p = 0.5$ bar
Housing	Brass with a bare metal surface
Sleeve	Brass with a bare metal surface
Valve	Brass with a bare metal surface
Spring	Stainless steel
Ball	Stainless steel
Sealant	NBR

Hydraulic coupling, brass with a bare metal surface, female

Art. No.	Type No.	Retaining ring	Connection	Flow rate (air) l/min	DN	Max. operating pressure bar	Length mm	a/f mm
107693	246.01	Stainless steel	G 1/8 IT	440	4.3	250	48.5	14
107694	246.02	Stainless steel	G 1/4 IT	840	6.3	200	57.6	19
107695	246.03	Stainless steel	G 3/8 IT	1280	7.5	200	64.2	22
107696	246.04	Stainless steel	G 1/2 IT	1950	11	150	76.0	27
107697	246.05	Stainless steel	G 3/4 IT	4500	13	100	96.0	34



246.03

Self-sealing plugs

both sides sealing - brass with a bare metal surface

Operating pressure	Referred to medium temp. of 50 °C, static working pressure
Medium temperature	-20 to 100 °C
Ambient temperature	-20 to 100 °C
Flow rate measurement	at 6 bar and $\Delta p = 0.5$ bar
Housing	Brass with a bare metal surface
Sleeve	Brass with a bare metal surface
Valve	Brass with a bare metal surface
Spring	Stainless steel
Ball	Stainless steel
Sealant	NBR

Self-sealing plug, brass with a bare metal surface, female

Art. No.	Type No.	Retaining ring	Connection	Flow rate (air) l/min	DN	Max. operating pressure bar	Length mm	a/f mm
107698	246.51	Stainless steel	G 1/8 IT	440	4.3	250	29.5	14
107699	246.52	Stainless steel	G 1/4 IT	840	6.3	200	35.3	19
107700	246.53	Stainless steel	G 3/8 IT	1280	7.5	200	39.0	22
107701	246.54	Stainless steel	G 1/2 IT	1950	11	150	48.0	27
107702	246.55	Stainless steel	G 3/4 IT	4500	13	100	60.0	36



246.53



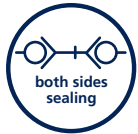

Hydraulic couplings

both sides sealing - plastic POM (Delrin)



Hydraulic couplings, both sides sealing, for liquid media acc. to ISO 7241, B Series.

Areas of application: manufacturing industry, chemical / pharmaceutical industry, food technology.

Operating pressure	Referred to medium temp. of 50 °C, static working pressure
Medium temperature	-20 to 90 °C
Ambient temperature	-20 to 90 °C
Flow rate measurement	at 6 bar and $\Delta p = 0.5$ bar
Housing	POM (Delrin), white
Sleeve	POM (Delrin), white
Valve	Stainless steel 1.4305
Spring	Stainless steel
Ball	Stainless steel
Sealant	NBR



246.33

Hydraulic coupling, POM, female

Art. No.	Type No.	Retaining ring	Connection	Flow rate (air) l/min	DN	Max. operating pressure bar	Length mm	a/f mm
107713	246.31	Stainless steel	G 1/8 IT	440	4.3	15	48.5	14
107714	246.32	Stainless steel	G 1/4 IT	840	6	15	57.6	19
107715	246.33	Stainless steel	G 3/8 IT	1280	7.5	15	64.2	22
107716	246.34	Stainless steel	G 1/2 IT	1950	11	10	76.0	27
107717	246.35	Stainless steel	G 3/4 IT	4500	13	10	96.0	34

Self-sealing plugs

both sides sealing - plastic POM (Delrin)

Operating pressure	Referred to medium temp. of 50 °C, static working pressure
Medium temperature	-20 to 90 °C
Ambient temperature	-20 to 90 °C
Flow rate measurement	at 6 bar and $\Delta p = 0.5$ bar
Housing	POM (Delrin), white
Sleeve	POM (Delrin), white
Valve	Stainless steel 1.4305
Spring	Stainless steel
Ball	Stainless steel
Sealant	NBR



246.83

Self-sealing plug, POM, female

Art. No.	Type No.	Retaining ring	Connection	Flow rate (air) l/min	DN	Max. operating pressure bar	Length mm	a/f mm
107718	246.81	Stainless steel	G 1/8 IT	440	4.3	15	29.5	14
107719	246.82	Stainless steel	G 1/4 IT	840	6	15	35.3	19
107720	246.83	Stainless steel	G 3/8 IT	1280	7.5	15	39.0	22
107721	246.84	Stainless steel	G 1/2 IT	1950	11	10	48.0	27
107722	246.85	Stainless steel	G 3/4 IT	4500	13	10	60.0	36

Hydraulic couplings

A series, DN 13



Acc. to ISO 7241-1, A Series.

This coupling series combines an extremely small pressure drop with maximum hydraulic power transmission. Interchangeable with all couplings and plugs manufactured according to the above standard. The patented pressure eliminator permits disconnection even if back pressure has built up (up to 200 bar). The pressure eliminator can be used in all applications where there is a risk of pressure build-up after the line has been separated. It allows effortless connection under pressure. The mating part must be pressureless in order for the eliminator to function optimally.

Areas of application: Agricultural machines, construction machines, municipal engineering, transportation engineering, industrial plant.



Max. operating pressure	250 bar
Operating temperature	-30 to 100 °C
Housing	Brass
Unlocking sleeve	Nickel-plated brass
Valve	Hard drawn brass
Ball	Stainless steel
Spring	Stainless steel
Sealant	NBR

Hydraulic coupling, female

Art. No.	Type No.	Connection	Flow rate (oil) l/min	Length mm	a/f mm
107723	242.01 A	G 1/2 IT	30	63.0	27



242.01 A

→ Flow rate measurement: Oil for viscosity 32cSt at 40 °C acc. to ISO 7241/2-2000, pressure drop 0.5 bar

Dust caps for hydraulic couplings A series, PVC

A series, DN 13

Dust cap for hydraulic couplings A series, PVC

Art. No.	Type No.	Description
107726	242.90	for coupling DN 13
107727	242.91	for plug DN 13



242.90





Push-in plugs without pressure eliminator

A series, DN 13

Max. operating pressure	250 bar
Operating temperature	-30 to 100 °C
Housing	Brass
Unlocking sleeve	Nickel-plated brass
Valve	Hard drawn brass
Ball	Stainless steel
Spring	Stainless steel
Sealant	NBR



242.51 A

Push-in plug without pressure eliminator, hardened, galvanised steel, female

Art. No.	Type No.	Connection	Length mm	a/f mm
107724	242.51 A	G 1/2 IT	41.0	27

→ Flow rate measurement: Oil for viscosity 32cSt at 40 °C acc. to ISO 7241/2-2000, pressure drop 0.5 bar

Push-in plugs with pressure eliminator

A series, DN 13

Max. operating pressure	250 bar
Operating temperature	-30 to 100 °C
Housing	Brass
Unlocking sleeve	Nickel-plated brass
Valve	Hard drawn brass
Ball	Stainless steel
Spring	Stainless steel
Sealant	NBR



242.61 A

Push-in plug with pressure eliminator, hardened, galvanised steel, female

Art. No.	Type No.	Connection	Length mm	a/f mm
107725	242.61 A	G 1/2 IT	41.0	27

→ Flow rate measurement: Oil for viscosity 32cSt at 40 °C acc. to ISO 7241/2-2000, pressure drop 0.5 bar

Hydraulic couplings

B series



Acc. to ISO 7241-1, B Series.

This coupling series combines an extremely small pressure drop with maximum hydraulic power transmission. Interchangeable with all couplings and plugs manufactured according to the above standard. The patented pressure eliminator permits disconnection even if back pressure has built up (up to 200 bar). The pressure eliminator can be used in all applications where there is a risk of pressure build-up after the line has been separated. It allows effortless connection under pressure. The mating part must be pressureless in order for the eliminator to function optimally.

Areas of application: chemical industry, food technology, automotive, offshore.



Operating temperature	-30 to 100 °C
Ball	Stainless steel
Spring	Stainless steel
Valve	Brass
Push-in plug	Steel
Sealant	NBR

Hydraulic coupling, female

Art. No.	Type No.	Connec- tion	Flow rate (oil) l/min	Housing	Unlocking sleeve	DN	Max. operating pressure bar	Length h mm	a/f mm
107728	242.01 B	G 1/4 IT	8	Nickel-plated brass	Nickel-plated brass	6.3	400	57.0	24
107729	242.02 B	G 3/8 IT	24	Nickel-plated brass	Steel	10	320	63.0	30
107730	242.03 B	G 1/2 IT	40	Nickel-plated brass	Steel	12.5	300	66.0	33
107731	242.04 B	G 3/4 IT	75	Steel	Steel	19	300	81.0	46
107732	242.05 B	G 1 IT	100	Steel	Steel	20	300	94.0	50



242.01 B

→ Flow rate measurement: Oil for viscosity 32cSt at 40 °C acc. to ISO 7241/2-2000, pressure drop 0.5 bar

Dust caps for hydraulic couplings B series, PVC

B series

Dust cap for hydraulic couplings B series, PVC

Art. No.	Type No.	Description
107743	242.92	for coupling DN 6.3
107744	242.93	for plug DN 6.3
107745	242.94	for coupling DN 10
107746	242.95	for plug DN 10
107747	242.96	for coupling DN 12.5
107748	242.97	for plug DN 12.5
107749	242.98	for coupling DN 19
107750	242.99	for plug DN 19
107751	242.100	for coupling DN 20
107752	242.101	for plug DN 20



242.92





Push-in plugs without pressure eliminator

B series

Max. operating pressure	400 bar
Operating temperature	-30 to 100 °C
Valve	Brass
Ball	Stainless steel
Spring	Stainless steel
Sealant	NBR



242.51 B

Push-in plug without pressure eliminator, hardened, galvanised steel, female

Art. No.	Type No.	Connection	DN	Max. operating pressure bar	Length mm	a/f mm
107733	242.51 B	G 1/4 IT	6.3	400	38.0	19
107734	242.52 B	G 3/8 IT	10	320	42.0	22
107735	242.53 B	G 1/2 IT	12.5	300	46.0	27
107736	242.54 B	G 3/4 IT	19	300	59.0	36
107737	242.55 B	G 1 IT	20	300	70.0	42

→ Flow rate measurement: Oil for viscosity 32cSt at 40 °C acc. to ISO 7241/2-2000, pressure drop 0.5 bar

Push-in plugs with pressure eliminator

B series

Max. operating pressure	400 bar
Operating temperature	-30 to 100 °C
Valve	Brass
Ball	Stainless steel
Spring	Stainless steel
Sealant	NBR



242.61 B

Push-in plug with pressure eliminator, hardened, galvanised steel, female

Art. No.	Type No.	Connection	DN	Max. operating pressure bar	Length mm	a/f mm
107738	242.61 B	G 1/4 IT	6.3	400	38.0	19
107739	242.62 B	G 3/8 IT	10	320	42.0	22
107740	242.63 B	G 1/2 IT	12.5	300	46.0	28
107741	242.64 B	G 3/4 IT	19	300	59.0	36
107742	242.65 B	G 1 IT	20	300	70.0	42

→ Flow rate measurement: Oil for viscosity 32cSt at 40 °C acc. to ISO 7241/2-2000, pressure drop 0.5 bar

Hydraulic couplings

both sides sealing - stainless steel 1.4305

Hydraulic couplings, both sides sealing, for liquid media acc. to ISO 7241, B Series.

Areas of application: machine and plant engineering, manufacturing industry, chemical / pharmaceutical industry, automotive, food technology.



Operating pressure	Referred to medium temp. of 50 °C, static working pressure
Medium temperature	-15 to 200 °C
Ambient temperature	-15 to 200 °C
Flow rate measurement	at 6 bar and $\Delta p = 0.5$ bar
Housing	Stainless steel 1.4305
Sleeve	Stainless steel 1.4305
Valve	Stainless steel 1.4305
Spring	Stainless steel 1.4310
Ball	Stainless steel 1.4401
Sealant	FKM

Hydraulic coupling, stainless steel 1.4305, female								
Art. No.	Type No.	Connection	Flow rate (air) l/min	DN	Max. operating pressure bar	Length mm	a/f mm	
107703	246.11	G 1/8 IT	440	4.3	250	48.5	14	
107704	246.12	G 1/4 IT	840	6.3	250	57.6	19	
107705	246.13	G 3/8 IT	1280	7.5	250	64.2	22	
107706	246.14	G 1/2 IT	1950	11	250	76.0	27	
107707	246.15	G 3/4 IT	4500	13	160	96.0	34	



246.13

Self-sealing plugs

both sides sealing - stainless steel 1.4305

Operating pressure	Referred to medium temp. of 50 °C, static working pressure
Medium temperature	-15 to 200 °C
Ambient temperature	-15 to 200 °C
Flow rate measurement	at 6 bar and $\Delta p = 0.5$ bar
Housing	Stainless steel 1.4305
Sleeve	Stainless steel 1.4305
Valve	Stainless steel 1.4305
Spring	Stainless steel 1.4310
Ball	Stainless steel 1.4401
Sealant	FKM

Self-sealing plug, stainless steel 1.4305, female								
Art. No.	Type No.	Connection	Flow rate (air) l/min	DN	Max. operating pressure bar	Length mm	a/f mm	
107708	246.61	G 1/8 IT	440	4.3	250	29.5	14	
107709	246.62	G 1/4 IT	840	6.3	250	35.3	19	
107710	246.63	G 3/8 IT	1280	7.5	250	39.0	22	
107711	246.64	G 1/2 IT	1950	11	250	48.0	27	
107712	246.65	G 3/4 IT	4500	13	160	60.0	36	



246.63





GEKA couplings

»GEKA-plus« series, brass with a bare metal surface



Claw couplings (claw distance: 40 mm) made of brass for water, industrial, mortar, suction and discharge hoses. Suitable for a wide range of applications, e.g. industrial plant engineering, civil and structural engineering, environmental engineering, manual trades, domestic water engineering, horticulture and landscaping, agriculture and forestry, etc.

Available in a rigid or 360° swivelling version. The two systems can also be easily coupled to one another!

Max. operating pressure	40 bar
Medium temperature	-10 to 90 °C
Ambient temperature	-10 to 90 °C
Sealant	NBR

GEKA hose piece, rigid

Art. No.	Type No.	Connection
107753	K 100	I.D. 10
107754	K 101	I.D. 13
107755	K 102	I.D. 16
107756	K 103	I.D. 19
107757	K 104	I.D. 25
107758	K 106	I.D. 32
107759	K 107	I.D. 38



K 103



K 113



K 113 A



K 118



K 203



K 303

GEKA threaded piece with female thread, rigid

Art. No.	Type No.	Connection
107760	K 108	G 1/4 IT
107761	K 109	G 3/8 IT
107762	K 110	G 1/2 IT
107763	K 111	G 3/4 IT
107764	K 113	G 1 IT
107765	K 114	G 1 1/4 IT
107766	K 116	G 1 1/2 IT

GEKA threaded piece with male thread, rigid

Art. No.	Type No.	Connection
107767	K 119	G 1/4 ET
107768	K 109 A	G 3/8 ET
107769	K 110 A	G 1/2 ET
107770	K 111 A	G 3/4 ET
107771	K 113 A	G 1 ET
107772	K 114 A	G 1 1/4 ET
107773	K 116 A	G 1 1/2 ET

GEKA dummy coupling

Art. No.	Type No.	Description
107774	K 118	Dummy coupling

GEKA hose piece, 360° swivelling

Art. No.	Type No.	Connection
107776	K 201	I.D. 13
107777	K 203	I.D. 19
107778	K 204	I.D. 25
107779	K 206	I.D. 32

GEKA elbow hose piece, 360° swivelling

Art. No.	Type No.	Connection
107780	K 301	I.D. 13
107781	K 303	I.D. 19
107782	K 304	I.D. 25

GEKA couplings

»GEKA-plus« series, brass with a bare metal surface



GEKA elbow hose piece, 360° swivelling

Art. No.	Type No.	Connection
107783	K 306	I.D. 32



GEKA threaded piece with female thread, 360° swivelling

Art. No.	Type No.	Connection
107784	K 210	G 1/2 IT
107785	K 211	G 3/4 IT
107786	K 213	G 1 IT

K 211



GEKA threaded piece with male thread, 360° swivelling

Art. No.	Type No.	Connection
107787	K 210 A	G 1/2 ET
107788	K 211 A	G 3/4 ET
107789	K 213 A	G 1 ET

K 211 A



K 403

GEKA hose piece, rigid, safety version with screw-ring

Art. No.	Type No.	Connection
107790	K 401	I.D. 13
107791	K 403	I.D. 19
107792	K 404	I.D. 25
107793	K 406	I.D. 32



K 411 A

GEKA threaded piece with male thread, rigid, safety version with screw-ring

Art. No.	Type No.	Connection
107794	K 411 A	G 3/4 ET
107795	K 413 A	G 1 ET

GEKA-branch piece

Art. No.	Type No.	Connection
107796	K 601	1 x G 3/4 IT, 2 x G 3/4 ET
107797	K 611	3 x GEKA couplings



K 601

GEKA nozzle with hose stem

Art. No.	Type No.	Connection
107798	K 701	I.D. 13
107799	K 703	I.D. 19
107800	K 704	I.D. 25



K 611

GEKA nozzle with coupling connection

Art. No.	Type No.	DN
107801	K 711	13
107802	K 713	19
107803	K 714	25



K 703

Chain for dummy coupling

Art. No.	Type No.	Description
107775	K 118-K	Chain for dummy coupling

Replacement seal

Art. No.	Type No.	Description
107835	D 116	NBR seal, suitable for old series
107836	D 117	NBR seal, for »GEKA plus« coupling (not with screw-ring)
107837	D 118	NBR seal, for »GEKA plus« coupling with screw-ring



K 713

→ For the compatible water hose, see page 844



GEKA couplings for drinking water

»GEKA-plus« series, brass with a bare metal surface, with KTW approval



GEKA-Kupplungen für Trinkwasser, Serie »GEKA-plus«, Messing blank, mit KTW-Zulassung

Max. operating pressure	40 bar
Medium temperature	-10 to 90 °C
Ambient temperature	-10 to 90 °C
Sealant	NBR for drinking water
KTW approval	After D2 and long-term test results DVGW W270



K 103-KTW

GEKA hose piece, rigid, for drinking water

Art. No.	Type No.	Connection
107804	K 100-KTW	I.D. 10
107805	K 101-KTW	I.D. 13
107806	K 103-KTW	I.D. 19
107807	K 104-KTW	I.D. 25



K 113-KTW

GEKA hose piece with female thread, rigid, for drinking water

Art. No.	Type No.	Connection
107808	K 109-KTW	G 3/8 IT
107809	K 110-KTW	G 1/2 IT
107810	K 111-KTW	G 3/4 IT
107811	K 113-KTW	G 1 IT
107812	K 114-KTW	G 1 1/4 IT



K 113 A-KTW

GEKA hose piece with male thread, rigid, for drinking water

Art. No.	Type No.	Connection
107813	K 109 A-KTW	G 3/8 ET
107814	K 110 A-KTW	G 1/2 ET
107815	K 111 A-KTW	G 3/4 ET
107816	K 113 A-KTW	G 1 ET
107817	K 114 A-KTW	G 1 1/4 ET



K 118-KTW

GEKA dummy coupling for drinking water

Art. No.	Type No.	Description
107818	K 118-KTW	Dummy coupling



K 503-KTW

GEKA threaded piece with screw connection, rigid, for drinking water

Art. No.	Type No.	Connection
107819	K 501-KTW	I.D. 13
107820	K 503-KTW	I.D. 19
107821	K 504-KTW	I.D. 25

Chain for dummy coupling

Art. No.	Type No.	Description
107775	K 118-K	Chain for dummy coupling

Replacement seal

Art. No.	Type No.	Description
107839	D 300	NBR seal, for »GEKA plus« coupling, with KTW approval



K 118-K



D 300

➔ For the compatible drinking water hose, see page 844

GEKA couplings

»GEKA-plus« series, stainless steel

Claw couplings (claw distance: 40 mm) made of stainless steel (similar to 1.4581). Suitable for a wide range of applications, e.g. in the chemical, food processing, water management, vehicle construction, shipbuilding and aerospace industries, agriculture, environmental engineering, etc. The stainless steel series can be easily coupled to the standard brass series!



Max. operating pressure	40 bar
Medium temperature	-10 to 150 °C
Ambient temperature	-10 to 150 °C
Sealant	FKM

GEKA hose piece, rigid

Art. No.	Type No.	Connection
107822	K 101-ES	I.D. 13
107823	K 103-ES	I.D. 19
107824	K 104-ES	I.D. 25
107825	K 106-ES	I.D. 32



K 101-ES

GEKA threaded piece with female thread, rigid

Art. No.	Type No.	Connection
107826	K 110-ES	G 1/2 IT
107827	K 111-ES	G 3/4 IT
107828	K 113-ES	G 1 IT
107829	K 114-ES	G 1 1/4 IT



K 110-ES

GEKA threaded piece with male thread, rigid

Art. No.	Type No.	Connection
107830	K 110 A-ES	G 1/2 ET
107831	K 111 A-ES	G 3/4 ET
107832	K 113 A-ES	G 1 ET
107833	K 114 A-ES	G 1 1/4 ET



K 110 A-ES

GEKA dummy coupling

Art. No.	Type No.	Description
107834	K 118-ES	Dummy coupling



K 118-ES

Chain for dummy coupling

Art. No.	Type No.	Description
107775	K 118-K	Chain for dummy coupling



K 118-K



D 119

Replacement seal

Art. No.	Type No.	Description
107838	D 119	FPM seal, for all stainless steel »GEKA plus« couplings





Claw couplings (compressor couplings)

standard type acc. to DIN 3489



Universal standard coupling for compressed air lines on construction sites or in industry; standard type according to DIN 3489, used worldwide in a very wide range of applications.

- Robust couplings made of malleable iron, zinc plated and yellow chromated
- Chrome VI-free, with double safety lock
- 100 % couple test and secure connection

Max. operating pressure	10 bar
Operating temperature	-40 to 95 °C
Material	Malleable iron, zinc plated and yellow chromated
Claw distance	42 mm
Sealant	NBR



KT 25



KT 25 M



KT 25 SB



KA 34



KA 34 M



KI 34

Claw coupling, with hose connection

Art. No.	Type No.	DN	For hose I.D.	L mm	H mm
107840	KT 10	7	10 (3/8")	69.0	63.0
107841	KT 13	8.5	13 (1/2")	69.0	63.0
107842	KT 19	15	19 (3/4")	69.0	63.0
107843	KT 25	19	25 (1")	70.0	63.0
107844	KT 32	25	32 (1 1/4")	88.0	63.0

Claw coupling, with hose connection and brass seal

Art. No.	Type No.	DN	For hose I.D.	L mm	H mm
107845	KT 13 M	8.5	13 (1/2")	78.1	63.0
107846	KT 19 M	15	19 (3/4")	82.9	63.0
107847	KT 25 M	19	25 (1")	84.1	63.0

Claw coupling, with hose connection and safety collar

Art. No.	Type No.	DN	For hose I.D.	Safety collar	L mm	H mm
107848	KT 13 SB	8.5	13 (1/2")	25	69.1	63.0
107849	KT 19 SB	15	19 (3/4")	28.5	75.1	63.0
107850	KT 25 SB	19	25 (1")	38	75.1	63.0

Claw coupling, male threaded

Art. No.	Type No.	DN	Thread	a/f mm	L mm	H mm
107851	KA 38	8.5	G 3/8	27	51.0	63.0
107852	KA 12	13	G 1/2	27	48.0	63.0
107853	KA 34	17	G 3/4	32	48.0	63.0
107854	KA 01	20	G 1	40	48.0	63.0

Claw coupling, male threaded with brass seal

Art. No.	Type No.	DN	Thread	a/f mm	L mm	H mm
107855	KA 12 M	11	G 1/2	27	54.9	63.0
107856	KA 34 M	17	G 3/4	32	50.0	63.0
107857	KA 10 M	17	G 1	40	49.0	63.0

Claw coupling, female threaded

Art. No.	Type No.	DN	Thread	a/f mm	L mm	H mm
107858	KI 38	15	G 3/8	22	36.0	63.0
107859	KI 12	19	G 1/2	27	37.0	63.0
107860	KI 34	20	G 3/4	32	38.0	63.0
107861	KI 10	20	G 1	40	40.0	63.0

Claw couplings (compressor couplings)

standard type acc. to DIN 3489



Claw coupling, female threaded with brass seal

Art. No.	Type No.	DN	Thread	a/f mm	L mm	H mm
107862	KI 12 M	17	G 1/2	32	51.9	63.0
107863	KI 34 M	17	G 3/4	32	48.0	63.0
107864	KI 10 M	17	G 1	41	50.9	63.0



KI 34 M

Claw coupling, swivel type, with hose connection

Art. No.	Type No.	DN	For hose I.D.	L mm	H mm
107865	KT 13 D	10	13 (1/2")	85.9	63.0
107866	KT 19 D	15	19 (3/4")	85.9	63.0
107867	KT 25 D	19	25 (1")	85.9	63.0



KT 25 D

Claw coupling, swivel type, with hose connection and safety collar

Art. No.	Type No.	DN	For hose I.D.	Safety collar	L mm	H mm
107868	KT 13 SBD	10	13 (1/2)	24	96.0	63.0
107869	KT 19 SBD	15	19 (3/4)	34	97.0	63.0
107870	KT 25 SBD	19	25 (1)	39	98.0	63.0



KT 25 SBD

Replacement seal for claw couplings, standard type acc. to DIN 3489

Art. No.	Type No.	Description
107873	D 129	NBR (oil resistant -40 °C to 95 °C)
107874	D 130	TFEP (vapour resistant, -40 °C to 200 °C)



D 129

D 130

Replacement seal kit, for claw couplings with brass seal

Art. No.	Type No.	Description
107872	D 122	Comprising brass sleeve, hose ring, M5 retaining screw



D 122





Safety claw couplings (compressor couplings)

safety type acc. to DIN 3238



Universal standard coupling in safety design according to DIN 3238 for absolutely secure compressed air lines on construction sites or in industry.

Easy to couple, secured against accidental opening: just screw the ring tight after coupling!

- Robust couplings with malleable iron head, steel stem with special profile, zinc plated and yellow chromated
- Chrome VI-free, with double safety lock
- Large bore for increased flow rate

Max. operating pressure	16 bar
Operating temperature	-40 to 95 °C
Material	Malleable iron
Claw distance	42 mm
Sealant	NBR



KA 34 S

Safety claw coupling, male threaded

Art. No.	Type No.	DN	Thread	a/f mm	L mm	H mm
107875	KA 38 S	10	G 3/8	24	67.7	63.0
107876	KA 12 S	13	G 1/2	24	69.2	63.0
107877	KA 34 S	17	G 3/4	24	70.2	63.0
107878	KA 01 S	17	R 1	36	82.2	63.0



KI 10 S

Safety claw coupling, female threaded

Art. No.	Type No.	DN	Thread	a/f mm	L mm	H mm
107879	KI 38 S	13	G 3/8	24	61.7	63.0
107880	KI 12 S	17	G 1/2	24	60.7	63.0
107881	KI 34 S	17	G 3/4	32	90.2	63.0
107882	KI 10 S	17	G 1	41	92.2	63.0



KT 25 S

Safety claw coupling, with hose connection

Art. No.	Type No.	DN	For hose I.D.	L mm	H mm
107883	KT 13 S	10	13 (1/2")	87.2	63.0
107884	KT 19 S	15	19 (3/4")	88.7	63.0
107885	KT 25 S	19	25 (1")	86.6	63.0



KT 25 SBS

Safety claw coupling, with hose connection and safety collar

Art. No.	Type No.	DN	For hose I.D.	Safety collar	L mm	H mm
107886	KT 13 SBS	10	13 (1/2")	24	97.7	63.0
107887	KT 19 SBS	15	19 (3/4")	34	99.4	63.0
107888	KT 25 SBS	19	25 (1")	39	98.6	63.0

Replacement seal for claw couplings, safety type acc. to DIN 3238

Art. No.	Type No.	Description
107889	D 129 S	NBR (oil resistant, -40 °C to 95 °C)
107890	D 130 S	TFEP (vapour resistant, -40 °C to 200 °C)



D 129 S



D 130 S

Accessories for safety claw couplings (compressor couplings)

Plug valve with coupling, one side sealing, female threaded, with lever stop and exhaust

Art. No.	Type No.	Connection	DN	a/f mm	L mm	H mm
107891	KH 12	G 1/2	15	41	131.0	93.0
107892	KH 34	G 3/4	17	41	124.0	93.0
107893	KH 10	G 1	17	41	124.0	93.0



KH 34

Double plug valve with 2 coupling outlets, female threaded, with lever stop and exhaust

Art. No.	Type No.	Connection	DN	a/f mm	L mm	H mm
107894	DKH 34	G 3/4	17	41	177.2	101.6
107895	DKH 10	G 1	17	41	177.2	101.6



DKH 34

Hose clamp, malleable iron, 2-piece, with loose saddles

Art. No.	Type No.	Clamping range mm	For hose I.D.	L mm
107896	SL 22	17 - 22	13 (1/2")	60.0
107897	SL 29	22 - 29	13 (1/2")	63.0
107898	SL 34	28 - 34	19 (3/4")	77.0
107899	SL 40	32 - 40	25 (1")	81.0
107900	SL 49	39 - 49	32 (1 1/4")	91.0
107901	SL 60	48 - 60	38 (1 1/2")	108.0
107902	SL 72	56 - 72	50 (2")	116.0
107903	SL 76	60 - 76	50 (2")	127.0



SL 34

Hose clamp, malleable iron, 2-piece, with loose saddles and safety claws

Art. No.	Type No.	Clamping range mm	For hose I.D.	L mm
107904	SLSK 29	22 - 29	13 (1/2")	63.0
107905	SLSK 34	28 - 32	19 (3/4")	77.0
107906	SLSK 39	35 - 42	25 (1")	90.0
107907	SLSK 44	42 - 45	28 (1 7/64")	98.0
107908	SLSK 51	45 - 53	35 (1 3/8")	108.0
107909	SLSK 60	55 - 60	42 (1 5/8")	119.0
107910	SLSK 73	60 - 73	50 (2")	132.0



SLSK 39

Dummy coupling

Art. No.	Type No.	L mm	H mm
107871	BK 100	42.0	63.0



BK 100



Temperature control couplings DN 6

brass, plug size 9 mm



Compatible with HASCO Z 8 system.

For temperature control applications involving hot or cold water or heat transfer oil, e.g. for cooling circuits on plastics processing machines.

Optionally with free passage, one or both sides sealing.

Female-threaded couplings and plugs with female-threaded PTFE seal.



270.01



270.02



270.03



270.26



270.34



270.40



270.601

Max. operating pressure	15 bar
Medium temperature	-20 to 160 °C
Ambient temperature	-20 to 160 °C
Medium	Air, water, oil, vacuum
Spring	Stainless steel
Retaining ring	Stainless steel
Ball	Stainless steel
Sealant	FPM (PTFE coated)

Temperature control coupling DN 6, with 9 mm plug and shut-off valve

Art. No.	Type No.	Hose stem type	Hose connection mm	Material	Length mm
107911	270.01	straight	9	Brass 2.0401	53.0
107912	270.02	45°	9	Brass 2.0401	42.5
107913	270.03	90°	9	Brass 2.0401	42.5

Temperature control coupling DN 6, with 9 mm plug, without shut-off valve

Art. No.	Type No.	Hose stem type	Hose connection mm	Material	Length mm
107914	270.11	straight	9	Brass 2.0401	53.0
107915	270.12	45°	9	Brass 2.0401	42.5
107916	270.13	90°	9	Brass 2.0401	42.5

Temperature control coupling DN 6, male threaded, with shut-off valve

Art. No.	Type No.	Connecting thread	Material	Length mm	a/f mm
107917	270.21	M14x1.5 straight	Brass 2.0401	48.0	17
107918	270.22	G 1/4 straight	Brass 2.0401	48.0	17
107919	270.23	M14x1.5 45°	Brass 2.0401	47.0	17
107920	270.24	G 1/4 45°	Brass 2.0401	47.0	17
107921	270.25	M14x1.5 90°	Brass 2.0401	47.0	17
107922	270.26	G 1/4 90°	Brass 2.0401	47.0	17

Temperature control coupling DN 6, male threaded, without shut-off valve

Art. No.	Type No.	Connecting thread	Material	Length mm	a/f mm
107923	270.31	M14x1.5 straight	Brass 2.0401	48.0	17
107924	270.32	G 1/4 straight	Brass 2.0401	48.0	17
107925	270.33	M14x1.5 45°	Brass 2.0401	47.0	17
107926	270.34	G 1/4 45°	Brass 2.0401	47.0	17
107927	270.35	M14x1.5 90°	Brass 2.0401	47.0	17
107928	270.36	G 1/4 90°	Brass 2.0401	47.0	17

Blank end coupling DN 6

Art. No.	Type No.	Material	Length mm
107929	270.40	Brass 2.0401	30.0

Push-in hose stem DN 6, without shut-off valve

Art. No.	Type No.	Hose connection mm	Material	Length mm
107930	270.601	9	Brass 2.0401	39.5

Temperature control couplings DN 6

brass, plug size 9 mm



Push-in plug DN 6, without shut-off valve, male threaded

Art. No.	Type No.	Thread	Material	Length mm	a/f mm
107931	270.610	M8x0.75	Brass 2.0401	24.0	11
107932	270.611	M10x1	Brass 2.0401	24.0	11
107933	270.612	M14x1.5	Brass 2.0401	26.0	15
107934	270.613	G 1/8	Nickel-plated brass	24.0	11
107935	270.614	G 1/4	Nickel-plated brass	26.0	15



270.614

Push-in plug DN 6, with shut-off valve, male threaded

Art. No.	Type No.	Thread	Material	Length mm	a/f mm
107936	270.622	M14x1.5	Brass 2.0401	29.0	15
107937	270.624	G 1/4	Nickel-plated brass	29.0	15



270.624

Plug pipe DN 5 and 6, without shut-off valve

Art. No.	Type No.	Tube O.D. mm	Material	Length mm	a/f mm
107938	270.701	8	Brass 2.0401	63.0	9
107939	270.702	8	Brass 2.0401	100.0	9
107940	270.703	10	Brass 2.0401	63.0	11
107941	270.704	10	Brass 2.0401	100.0	11
107942	270.705	10	Brass 2.0401	120.0	11
107943	270.706	10	Brass 2.0401	240.0	11
107944	270.707	10	Brass 2.0401	360.0	11



270.704

Push-in plug DN 6, 90°, without shut-off valve, male threaded

Art. No.	Type No.	Thread	Material	Length mm	a/f mm
107945	270.801	M8x0.75	Brass 2.0401	27.0	15
107946	270.802	M10x1	Brass 2.0401	27.0	15
107947	270.803	M14x1.5	Brass 2.0401	29.0	15
107948	270.804	R 1/8	Nickel-plated brass	27.0	15
107949	270.805	R 1/4	Nickel-plated brass	29.0	15
107950	270.806	R 3/8	Nickel-plated brass	30.0	17



270.801



Temperature control couplings DN 9

brass, plug size 13 mm



Compatible with HASCO Z 8 system.

For temperature control applications involving hot or cold water or heat transfer oil.
Optionally with free passage, one or both sides sealing.
Female-threaded couplings and plugs with female-threaded PTFE seal.



280.01

Max. operating pressure	15 bar
Medium temperature	-20 to 160 °C
Ambient temperature	-20 to 160 °C
Medium	Air, water, oil, vacuum
Spring	Stainless steel
Retaining ring	Stainless steel
Ball	Stainless steel
Sealant	FPM (PTFE coated)



280.02

Temperature control coupling DN 9, with 13 mm plug and shut-off valve

Art. No.	Type No.	Hose stem type	Hose connection mm	Material	Length mm
107953	280.01	straight	13	Brass 2.0401	61.5
107954	280.02	45°	13	Brass 2.0401	50.5
107955	280.03	90°	13	Brass 2.0401	50.5



280.03

Temperature control coupling DN 9, with 13 mm plug, without shut-off valve

Art. No.	Type No.	Hose stem type	Hose connection mm	Material	Length mm
107956	280.11	straight	13	Brass 2.0401	61.5
107957	280.12	45°	13	Brass 2.0401	50.5
107958	280.13	90°	13	Brass 2.0401	50.5



280.22

Temperature control coupling DN 9, male threaded, with shut-off valve

Art. No.	Type No.	Connecting thread	Material	Length mm	a/f mm
107959	280.21	M16x1.5 straight	Brass 2.0401	52.0	22
107960	280.22	G 3/8 straight	Brass 2.0401	53.5	22
107961	280.23	G 1/2 straight	Brass 2.0401	53.0	21
107962	280.24	G 3/8 45°	Brass 2.0401	54.0	22
107963	280.25	M16x1.5 45°	Brass 2.0401	54.0	22
107964	280.26	G 3/8 90°	Brass 2.0401	54.0	22
107965	280.27	M16x1.5 90°	Brass 2.0401	54.0	22



280.34

Temperature control coupling DN 9, male threaded, without shut-off valve

Art. No.	Type No.	Connecting thread	Material	Length mm	a/f mm
107966	280.31	M16x1.5 straight	Brass 2.0401	52.0	22
107967	280.32	G 3/8 straight	Brass 2.0401	53.5	22
107968	280.33	G 1/2 straight	Brass 2.0401	53.0	21
107969	280.34	G 3/8 45°	Brass 2.0401	54.0	22
107970	280.35	M16x1.5 45°	Brass 2.0401	54.0	22
107971	280.36	G 3/8 90°	Brass 2.0401	54.0	22
107972	280.37	M16x1.5 90°	Brass 2.0401	54.0	22



280.40

Blank end coupling DN 9

Art. No.	Type No.	Material	Length mm
107973	280.40	Brass 2.0401	37.0

Temperature control couplings DN 9

brass, plug size 13 mm



Push-in hose stem DN 9, without shut-off valve

Art. No.	Type No.	Hose connection mm	Material	Length mm
107974	280.601	13	Brass 2.0401	42.0



280.601

Push-in plug DN 9, without shut-off valve, male threaded

Art. No.	Type No.	Thread	Material	Length mm	a/f mm
107975	280.610	M14x1.5	Brass 2.0401	26.0	15
107976	280.611	M16x1.5	Brass 2.0401	26.0	17
107977	280.612	G 1/8	Nickel-plated brass	24.0	15
107978	280.613	G 1/4	Nickel-plated brass	26.0	15
107979	280.614	G 3/8	Nickel-plated brass	26.0	17
107980	280.615	G 1/2	Nickel-plated brass	31.0	22



280.615

Push-in plug DN 9, with shut-off valve, male threaded

Art. No.	Type No.	Thread	Material	Length mm	a/f mm
107981	280.620	M14x1.5	Brass 2.0401	30.0	15
107982	280.621	M16x1.5	Brass 2.0401	30.0	17
107983	280.623	G 1/4	Nickel-plated brass	30.0	15
107984	280.624	G 3/8	Nickel-plated brass	30.0	17
107985	280.625	G 1/2	Nickel-plated brass	31.0	22



280.624

Plug pipe DN 9, without shut-off valve

Art. No.	Type No.	Tube O.D. mm	Material	Length mm	a/f mm
107986	280.701	14	Brass 2.0401	150.0	15
107987	280.702	14	Brass 2.0401	300.0	15



280.701

Push-in plug DN 9, 90°, without shut-off valve, male threaded

Art. No.	Type No.	Thread	Material	Length mm	a/f mm
107988	280.803	M14x1.5	Brass 2.0401	34.0	17
107989	280.805	R 1/4	Nickel-plated brass	34.0	17
107990	280.806	R 3/8	Nickel-plated brass	35.0	17



280.805



Accessories temperature control couplings



290.901

Female threaded pipe for temperature control applications

Art. No.	Type No.	Female thread	DN	Tube O.D. mm	Length mm	Material
107992	290.901	M14x1.5	6	10	120.0	Brass 2.0401
107993	290.902	M16x1.5	9	14	150.0	Brass 2.0401



290.906

Female stem, metric thread

Art. No.	Type No.	Female thread	Hose connection mm	Length mm	Material
107994	290.905	M14x1.5	9	37.5	Brass 2.0401
107995	290.906	M16x1.5	13	40.0	Brass 2.0401
107996	290.907	M24x1.5	19	55.0	Brass 2.0401



290.914

Male stem, metric thread

Art. No.	Type No.	Hose connection mm	Length mm	Material
107997	290.910	9	33.5	Brass 2.0401
107998	290.911	9	33.5	Brass 2.0401
107999	290.912	13	40.0	Brass 2.0401
108000	290.913	13	40.0	Brass 2.0401
108001	290.914	13	40.0	Brass 2.0401
108002	290.915	19	56.0	Brass 2.0401



290.921

Threaded stem 90°, imperial thread

Art. No.	Type No.	Hose connection mm	Length mm	Material
108003	290.920	9	27.0	Brass 2.0401
108004	290.921	13	34.0	Brass 2.0401
179333	GTWR12S19	19	47.0	Nickel-plated brass



GTWR12S19

Threaded stem 90°, metric male thread acc. to DIN 158

Art. No.	Type No.	Hose connection mm	Length mm	Material
108006	290.930	9	27.0	Brass 2.0401
108007	290.931	9	27.0	Brass 2.0401
108008	290.932	13	34.0	Brass 2.0401
108009	290.933	19	47.0	Brass 2.0401



290.932

Connector

Art. No.	Type No.	Connection	Material
107951	270.901	DN 6 - DN 6	Brass 2.0401
107952	270.902	DN 6 - DN 9	Brass 2.0401
107991	280.901	DN 9 - DN 9	Brass 2.0401



270.901



280.901

KAMLOK hose couplings

aluminium, acc. to A-A 59326 25.09.98 (formerly MIL - C 27487)



Coupling system for quick and easy connection of two hoses or for joining one hose to a machine connection.

A male part and a female part are joined together by shifting the handles.

There is no need to turn the hose!

Kamlok couplings are used for a wide range of applications in industrial plant and mechanical engineering, tank and container construction, the chemical industry, food processing, mining, refuelling systems, defence technology, etc.

All Kamlok quick coupling boxes and Kamlok closure boxes are supplied with NBR seal.



Max. operating pressure	16 bar
Max. temperature range	68 °C
Sealant	NBR, resistant to oils and benzine

Kamlok female coupler with hose stem, Part C

Art. No.	Type No.	For hose I.D.	For plug Ø mm	A mm	C mm
108026	1112.34	19	32	61.3	90.5
108027	1112.10	25	37	68.2	95.0
108028	1112.114	32	45	79.7	102.5
108029	1112.112	38	53	87.4	116.5
108030	1112.20	50	63	97.0	134.5
108031	1112.212	63	76	109.5	142.4
108032	1112.30	75	92	131.8	159.0
108033	1112.40	100	120	159.9	162.5

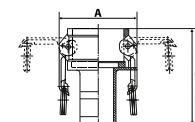

1112.20

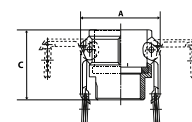

Kamlok female coupler, male threaded, Part B

Art. No.	Type No.	Thread	For plug Ø mm	A mm	C mm
108034	1113.34	R 3/4	32	61.3	52.2
108035	1113.10	R 1	37	68.2	59.0
108036	1113.114	R 1 1/4	45	79.7	65.5
108037	1113.112	R 1 1/2	53	87.4	69.5
108038	1113.20	R 2	63	97.0	77.0
108039	1113.212	R 2 1/2	76	109.5	84.5
108040	1113.30	R 3	92	131.8	89.5
108041	1113.40	R 4	120	159.9	92.0



1113.112

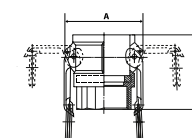

Kamlok female coupler, female threaded, Part D

Art. No.	Type No.	Thread	For plug Ø mm	A mm	C mm
108042	1114.34	G 3/4	32	61.3	52.2
108043	1114.10	G 1	37	68.2	59.0
108044	1114.114	G 1 1/4	45	79.7	67.5
108045	1114.112	G 1 1/2	53	87.4	69.5
108046	1114.20	G 2	63	97.0	76.0
108047	1114.212	G 2 1/2	76	109.5	84.5
108048	1114.30	G 3	92	131.8	89.5
108049	1114.40	G 4	120	159.9	92.0



1114.112

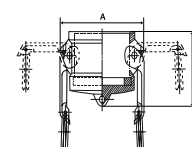

Kamlok dust cap for male adapters, Part DC

Art. No.	Type No.	Size	For plug Ø mm	A mm	C mm
108050	1115.34	3/4	32	61.3	45.2
108051	1115.10	1	37	68.2	57.4
108052	1115.114	1 1/4	45	79.7	65.0
108053	1115.112	1 1/2	53	87.4	62.0
108054	1115.20	2	63	97.0	69.0



1115.20





KAMLOK hose couplings

aluminium, acc. to A-A 59326 25.09.98 (formerly MIL - C 27487)

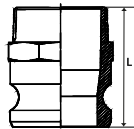

1116.10

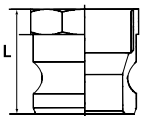

1117.112

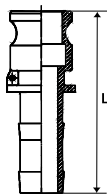

1118.112

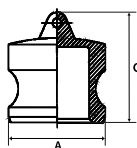

1119.20

Kamlok dust cap for male adapters, Part DC

Art. No.	Type No.	Size	For plug Ø mm	A mm	C mm
108055	1115.212	2 1/2	76	109.5	77.5
108056	1115.30	3	92	131.8	76.5
108057	1115.40	4	120	159.9	78.0

Kamlok male adapter, male threaded, Part F

Art. No.	Type No.	Thread	Plug Ø mm	L mm
108058	1116.34	R 3/4	32	55.0
108059	1116.10	R 1	37	67.8
108060	1116.114	R 1 1/4	45	78.0
108061	1116.112	R 1 1/2	53	76.0
108062	1116.20	R 2	63	83.5
108063	1116.212	R 2 1/2	76	97.0
108064	1116.30	R 3	92	99.5
108065	1116.40	R 4	120	104.5

Kamlok male adapter, female threaded, Part A

Art. No.	Type No.	Thread	Plug Ø mm	L mm
108066	1117.34	G 3/4	32	41.0
108067	1117.10	G 1	37	50.8
108068	1117.114	G 1 1/4	45	55.0
108069	1117.112	G 1 1/2	53	56.0
108070	1117.20	G 2	63	59.0
108071	1117.212	G 2 1/2	76	79.2
108072	1117.30	G 3	92	71.7
108073	1117.40	G 4	120	71.2

Kamlok male adapter with hose stem, Part E

Art. No.	Type No.	For hose I.D.	Plug Ø mm	L mm
108074	1118.34	19	32	85.3
108075	1118.10	25	37	100.8
108076	1118.114	32	45	109.0
108077	1118.112	38	53	123.5
108078	1118.20	50	63	142.0
108079	1118.212	63	76	150.5
108080	1118.30	75	92	157.0
108081	1118.40	100	120	166.0

Kamlok male dust plug, Part DP

Art. No.	Type No.	Size	Plug Ø mm	A mm	C mm
108082	1119.34	3/4	32	32.1	38.0
108083	1119.10	1	37	36.6	52.3
108084	1119.114	1 1/4	45	45.4	57.5
108085	1119.112	1 1/2	53	53.4	57.0
108086	1119.20	2	63	63.0	63.5
108087	1119.212	2 1/2	76	57.7	67.5
108088	1119.30	3	92	91.4	67.5
108089	1119.40	4	120	119.5	69.8

KAMLOK hose couplings

aluminium, acc. to A-A 59326 25.09.98 (formerly MIL - C 27487)



Replacement seal for Kamlok couplings, NBR

Art. No.	Type No.	For coupling DN
108090	108.101	20 (3/4")
108091	108.102	25 (1")
108092	108.103	32 (1 1/4")
108093	108.104	40 (1 1/2")
108094	108.105	50 (2")
108095	108.106	65 (2 1/2")
108096	108.107	75 (3")
108097	108.108	100 (4")



108.102



108.300

Replacement chain for Kamlok couplings, stainless steel

Art. No.	Type No.
108098	108.300

- For hinge bolt clamps see page 843
- For industrial water hoses up to DN 100 see page 849
- For rubber suction and discharge hoses up to DN 100 see page 848-849
- For plastic suction and discharge hoses up to DN 100 see page 885

KAMLOK hose couplings

stainless steel 1.4401, acc. to DIN EN 14420-7 (formerly DIN 2828)

High-quality, robust, universal coupling system with a safety clamp for quick and easy connection of two hoses or for joining one hose to a machine connection. A male part and a female part are joined together by shifting the handles. There is no need to turn the hose!

Kamlok stainless steel couplings are designed for use with corrosive media in the chemical and petrochemical industries, steelmaking, shipbuilding, agriculture, etc. All Kamlok quick coupling boxes and Kamlok closure boxes are supplied with NBR seal.



Max. operating pressure	16 bar
Temperature range	-20 to 95 °C
Sealant	NBR, resistant to oils and benzine

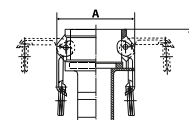

1112.34-ES

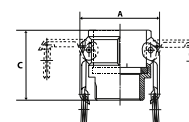

Kamlok female coupler with hose stem, Part C

Art. No.	Type No.	For hose I.D.	For plug Ø mm	A mm	C mm
108099	1112.34-ES	19	32	61.3	91.0
108100	1112.10-ES	25	37	68.2	94.0
108101	1112.114-ES	32	46	79.7	104.0
108102	1112.112-ES	38	54	87.4	110.0
108103	1112.20-ES	50	64	97.0	128.0
108104	1112.212-ES	63	76.5	109.5	131.5
108105	1112.30-ES	75	92	131.8	151.5
108106	1112.40-ES	100	120	159.9	168.0

Kamlok female coupler, male threaded, Part B

Art. No.	Type No.	Thread	For plug Ø mm	A mm	C mm
108107	1113.34-ES	R 3/4	32	61.3	45.5
108108	1113.10-ES	R 1	37	68.2	55.5
108109	1113.114-ES	R 1 1/4	46	79.7	63.0
108110	1113.112-ES	R 1 1/2	54	87.4	65.5
108111	1113.20-ES	R 2	63	97.0	75.8
108112	1113.212-ES	R 2 1/2	76.5	109.5	85.5



1113.114-ES



KAMLOK hose couplings

stainless steel 1.4401, acc. to DIN EN 14420-7 (formerly DIN 2828)

Kamlok female coupler, male threaded, Part B

Art. No.	Type No.	Thread	For plug Ø mm	A mm	C mm
108113	1113.30-ES	R 3	92	131.8	84.5
108114	1113.40-ES	R 4	120	159.9	88.5

Kamlok female coupler, female threaded, Part D

Art. No.	Type No.	Thread	For plug Ø mm	A mm	C mm
108115	1114.34-ES	G 3/4	32	61.3	45.8
108116	1114.10-ES	G 1	37	68.2	55.0
108117	1114.114-ES	G 1 1/4	46	79.7	63.0
108118	1114.112-ES	G 1 1/2	54	87.4	65.0
108119	1114.20-ES	G 2	64	97.0	71.0
108120	1114.212-ES	G 2 1/2	76.5	109.5	82.5
108121	1114.30-ES	G 3	92	131.8	84.0
108122	1114.40-ES	G 4	120	159.9	90.0

Kamlok dust cap for male adapters, Part DC

Art. No.	Type No.	Size	For plug Ø mm	A mm	C mm
108123	1115.34-ES	3/4	32	61.3	40.0
108124	1115.10-ES	1	37	68.2	45.0
108125	1115.114-ES	1 1/4	46	79.7	56.0
108126	1115.112-ES	1 1/2	54	87.4	55.0
108127	1115.20-ES	2	64	97.0	62.0
108128	1115.212-ES	2 1/2	76.5	109.5	63.0
108129	1115.30-ES	3	92	131.8	67.0
108130	1115.40-ES	4	120	159.9	70.5

Kamlok male adapter, male threaded, Part F

Art. No.	Type No.	Thread	Plug Ø mm	L mm
108131	1116.34-ES	R 3/4	32	53.5
108132	1116.10-ES	R 1	37	60.0
108133	1116.114-ES	R 1 1/4	46	72.0
108134	1116.112-ES	R 1 1/2	53	73.8
108135	1116.20-ES	R 2	63	83.5
108136	1116.212-ES	R 2 1/2	76	89.5
108137	1116.30-ES	R 3	92	91.0
108138	1116.40-ES	R 4	120	97.0

Kamlok male adapter, female threaded, Part A

Art. No.	Type No.	Thread	Plug Ø mm	L mm
108139	1117.34-ES	G 3/4	32	36.0
108140	1117.10-ES	G 1	37	44.7
108141	1117.114-ES	G 1 1/4	46	49.5
108142	1117.112-ES	G 1 1/2	53	50.5
108143	1117.20-ES	G 2	63	61.0
108144	1117.212-ES	G 2 1/2	76	77.5
108145	1117.30-ES	G 3	92	67.0
108146	1117.40-ES	G 4	120	71.5

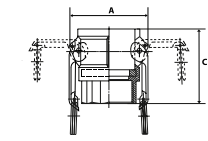

1114.114-ES

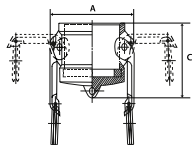

1115.114-ES



1116.10-ES



1118.10-ES

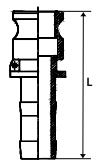

1117.114-ES

KAMLOK hose couplings

stainless steel 1.4401, acc. to DIN EN 14420-7 (formerly DIN 2828)



Kamlok male adapter with hose stem, Part E

Art. No.	Type No.	For hose I.D.	Plug Ø mm	L mm
108147	1118.34-ES	19	32	86.7
108148	1118.10-ES	25	37	97.5
108149	1118.114-ES	32	46	112.0
108150	1118.112-ES	38	53	112.0
108151	1118.20-ES	50	63	143.0
108152	1118.212-ES	63	76	138.0
108153	1118.30-ES	75	92	159.5
108154	1118.40-ES	100	120	181.0

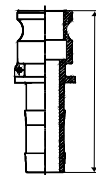

1118.10-ES

Kamlok male dust plug, Part DP

Art. No.	Type No.	Size	Plug Ø mm	A mm	C mm
108155	1119.34-ES	3/4	32	32.1	35.0
108156	1119.10-ES	1	37	36.6	42.0
108157	1119.114-ES	1 1/4	46	45.4	45.0
108158	1119.112-ES	1 1/2	53	53.4	46.0
108159	1119.20-ES	2	63	63.0	54.0
108160	1119.212-ES	2 1/2	76	57.7	56.0
108161	1119.30-ES	3	92	91.4	56.0
108162	1119.40-ES	4	120	119.5	58.0

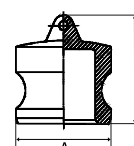

1119.10-ES

Replacement seal for Kamlok couplings, NBR

Art. No.	Type No.	For coupling DN
108163	108.201	20 (3/4")
108164	108.202	25 (1")
108165	108.203	32 (1 1/4")
108166	108.204	40 (1 1/2")
108167	108.205	50 (2")
108168	108.206	60 (2 1/2")
108169	108.207	75 (3")
108170	108.208	90 (4")



108.202

Replacement chain for Kamlok couplings, stainless steel

Art. No.	Type No.
108098	108.300



108.300

Safety clip for Kamlok couplings

Art. No.	Type No.	Description
124737	USC 200	Safety clip for size 1 1/2 and 1 1/4



USC 200

- For hinge bolt clamps see page 843
- For industrial water hoses up to DN 100 see page 849
- For rubber suction and discharge hoses up to DN 100 see page 848-849
- For plastic suction and discharge hoses up to DN 100 see page 885





Storz couplings

aluminium



High-quality series in forged aluminium. For quick and simple hose connections. User friendly; the coupling elements are joined without damaging the seal. Applications: Water lines, industrial plant engineering, firefighting.

Max. operating pressure	16 bar
Operating temperature	-40 to 110 °C
Sealant	NBR



2401.3125



2401.8965



2402.3119

Storz coupling with hose stem, swivel type, aluminium

Art. No.	Type No.	Storz size	Material	Lug distance mm	Hose I.D. mm	Length mm
108171	2401.3119	25-D	Aluminium	31	19	58.0
108172	2401.3125	25-D	Aluminium	31	25	54.0
108173	2401.4419	32	Aluminium	45	19	72.0
108174	2401.4425	32	Aluminium	45	25	72.0
108175	2401.4432	32	Aluminium	45	32	72.0
108176	2401.5125	38	Aluminium	51	25	90.0
108177	2401.5132	38	Aluminium	51	32	90.0
108178	2401.5138	38	Aluminium	51	38	90.0
108179	2401.6625	52-C	Aluminium	66	25	88.0
108180	2401.6632	52-C	Aluminium	66	32	88.0
108181	2401.6638	52-C	Aluminium	66	38	90.0
108182	2401.6642	52-C	Aluminium	66	42	90.0
108183	2401.6652	52-C	Aluminium	66	52	90.0
108184	2401.8138	65	Aluminium	81	38	89.0
108185	2401.8152	65	Aluminium	81	52	99.0
108186	2401.8165	65	Aluminium	81	65	99.0
108187	2401.8175	65	Aluminium	81	75	99.0
108188	2401.8965	75-B	Aluminium	89	65	124.0
108189	2401.8970	75-B	Aluminium	89	70	124.0
108190	2401.8975	75-B	Aluminium	89	75	124.0
108191	2401.8980	75-B	Aluminium	89	80	124.0
108192	2401.10590	90	Aluminium	105	90	159.0
108193	2401.115100	100	Aluminium	115	100	152.0
108194	2401.13390	110-A	Aluminium	133	90	170.0
108195	2401.133100	110-A	Aluminium	133	100	167.0

Storz coupling with hose stem for safety clamp, swivel type

Art. No.	Type No.	Storz size	Material	Lug distance mm	Hose I.D. mm	Length mm
108196	2402.3119	25-D	Brass	31	19	74.0
108197	2402.3125	25-D	Brass	31	25	74.0
108198	2402.6638	52-C	Aluminium	66	38	90.0
108199	2402.6650	52-C	Aluminium	66	50	95.0
108200	2402.8975	75-B	Aluminium	89	75	114.0
108201	2402.133100	110-A	Aluminium	133	100	157.0

Storz couplings

aluminium



Storz fixed coupling, male threaded, aluminium

Art. No.	Type No.	Storz size	Material	Lug distance mm	Male thread
108202	2403.3134	25-D	Aluminium	31	G 3/4
108203	2403.3110	25-D	Aluminium	31	G 1
108204	2403.4410	32	Aluminium	44	G 1
108205	2403.44114	32	Aluminium	44	G 1 1/4
108206	2403.51114	38	Aluminium	51	G 1 1/4
108207	2403.51112	38	Aluminium	51	G 1 1/2
108208	2403.6610	52-C	Aluminium	66	G 1
108209	2403.66114	52-C	Aluminium	66	G 1 1/4
108210	2403.66112	52-C	Aluminium	66	G 1 1/2
108211	2403.6620	52-C	Aluminium	66	G 2
108212	2403.8120	65	Aluminium	81	G 2
108213	2403.81212	65	Aluminium	81	G 2 1/2
108214	2403.8130	65	Aluminium	81	G 3
108215	2403.89212	75-B	Aluminium	89	G 2 1/2
108216	2403.8930	75-B	Aluminium	89	G 3
108217	2403.11540	100	Aluminium	115	G 4
108218	2403.13340	110-A	Aluminium	133	G 4



2403.66114

Storz fixed coupling, female threaded, aluminium

Art. No.	Type No.	Storz size	Material	Lug distance mm	Female thread
108219	2404.3112	25-D	Aluminium	31	G 1/2
108220	2404.3134	25-D	Aluminium	31	G 3/4
108221	2404.3110	25-D	Aluminium	31	G 1
108222	2404.4410	32	Aluminium	44	G 1
108223	2404.44114	32	Aluminium	44	G 1 1/4
108224	2404.51114	38	Aluminium	51	G 1 1/4
108225	2404.51112	38	Aluminium	51	G 1 1/2
108226	2404.6610	52-C	Aluminium	66	G 1
108227	2404.66114	52-C	Aluminium	66	G 1 1/4
108228	2404.66112	52-C	Aluminium	66	G 1 1/2
108229	2404.6620	52-C	Aluminium	66	G 2
108230	2404.66212	52-C	Aluminium	66	G 2 1/2
108231	2404.8120	65	Aluminium	81	G 2
108232	2404.81212	65	Aluminium	81	G 2 1/2
108233	2404.8130	65	Aluminium	81	G 3
108234	2404.8920	75-B	Aluminium	89	G 2
108235	2404.89212	75-B	Aluminium	89	G 2 1/2
108236	2404.8930	75-B	Aluminium	89	G 3
108237	2404.11540	100	Aluminium	115	G 4
108238	2404.13340	110-A	Aluminium	133	G 4



2404.66112



Storz adapter, aluminium

Art. No.	Type No.	Storz size	Material	Lug distance 1 mm	Lug distance 2 mm
108239	2405.5131	38/25-D	Aluminium	51	31
108240	2405.6631	52-C/25-D	Aluminium	66	31
108241	2405.8151	65/38	Aluminium	81	51
108242	2405.8166	65/52-C	Aluminium	81	66
108243	2405.8966	75-B/52-C	Aluminium	89	66
108244	2405.8981	75-B/65	Aluminium	89	81



2405.6631



Storz couplings

aluminium



2405.6631

Storz adapter, aluminium

Art. No.	Type No.	Storz size	Material	Lug distance 1 mm	Lug distance 2 mm
108245	2405.10589	90/75-B	Aluminium	105	89
108246	2405.11589	100/75-B	Aluminium	115	89
108247	2405.115105	100/90	Aluminium	115	105
108248	2405.13389	110-A/75-B	Aluminium	133	89
108249	2405.133115	110-A/100	Aluminium	133	115



2406.8965

Storz adapter to flange, aluminium

Art. No.	Type No.	Storz size	Material	Lug distance 1 mm	Flange	Hole circle dia. mm	No. of bolt holes
108250	2406.3125	25-D	Aluminium	31	DN 25	85	4
108251	2406.6640	52-C	Aluminium	66	DN 40	110	4
108252	2406.6650	52-C	Aluminium	66	DN 50	125	4
108253	2406.8165	65	Aluminium	81	DN 65	145	4
108254	2406.8965	75-B	Aluminium	89	DN 65	145	4
108255	2406.8980	75-B	Aluminium	89	DN 80	160	8
108256	2406.115100	100	Aluminium	115	DN 100	180	8
108257	2406.133100	110-A	Aluminium	133	DN 100	180	8



2407.66

Storz blank cap with chain, aluminium

Art. No.	Type No.	Storz size	Material	Lug distance mm
108258	2407.31	25-D	Aluminium	31
108259	2407.44	32	Aluminium	44
108260	2407.51	38	Aluminium	51
108261	2407.66	52-C	Aluminium	66
108262	2407.81	65	Aluminium	81
108263	2407.89	75-B	Aluminium	89
108264	2407.105	90	Aluminium	105
108265	2407.115	100	Aluminium	115
108266	2407.133	110-A	Aluminium	133



2408.100



2408.300

Jet / spray branch pipe acc. to DIN 14365, aluminium

Art. No.	Type No.	Storz size	Material	Thread	Flow rate at 6 bar l/min	Nozzle
108267	2408.100	25-D	Handle and nozzle: plastic	G 1 ET	26	4 mm
108268	2408.200	52-C	Handle and nozzle: plastic	G 2 ET	132	9 mm
108269	2408.300	52-C	Rubberised handle	G 2 ET	132	9 mm
108270	2408.400	52-C	Rubberised handle with additional water curtain	G 2 ET	132	9 mm
108271	2408.500	75-B	Rubberised handle with additional water curtain	G 2 1/2 ET	418	16 mm



2408.400

Storz couplings

aluminium



Spanner for Storz couplings

Art. No.	Type No.	For lug distance	Material
108272	2408.600	31	Steel
108273	2408.700	66, 89, 133	Malleable iron



2408.600



2408.700

Replacement seal for Storz couplings, NBR

Art. No.	Type No.	Storz size	Material	Lug distance mm
108274	2408.31	25-D	NBR	31
108275	2408.44	32	NBR	44
108276	2408.51	38	NBR	51
108277	2408.66	52-C	NBR	66
108278	2408.81	65	NBR	81
108279	2408.89	75-B	NBR	89
108280	2408.105	90	NBR	105
108281	2408.115	100	NBR	115
108282	2408.133	110-A	NBR	133



2408.51

Storz couplings

stainless steel V4A

High-quality series in V4A stainless steel. For quick and simple hose connections. User friendly; the coupling elements are joined without damaging the seal. Applications: Industrial plant engineering, shipbuilding, chemical industry.

Max. operating pressure	16 bar
Operating temperature	-15 to 200 °C
Sealant	FKM

Storz coupling with hose stem, swivel type, stainless steel

Art. No.	Type No.	Storz size	Material	Lug distance mm	Hose I.D. mm	Length mm
108283	3401.3119	25-D	Stainless steel V4A	31	19	58.0
108284	3401.3125	25-D	Stainless steel V4A	31	25	54.0
108285	3401.5138	38	Stainless steel V4A	51	38	90.0
108286	3401.6625	52-C	Stainless steel V4A	66	25	88.0
108287	3401.6632	52-C	Stainless steel V4A	66	32	88.0
108288	3401.6638	52-C	Stainless steel V4A	66	38	90.0
108289	3401.6642	52-C	Stainless steel V4A	66	42	90.0
108290	3401.6652	52-C	Stainless steel V4A	66	52	90.0
108291	3401.8138	65	Stainless steel V4A	81	38	90.0
108292	3401.8152	65	Stainless steel V4A	81	52	99.0
108293	3401.8165	65	Stainless steel V4A	81	65	99.0
108294	3401.8175	65	Stainless steel V4A	81	75	99.0
108295	3401.8965	75-B	Stainless steel V4A	89	65	124.0
108296	3401.8975	75-B	Stainless steel V4A	89	75	124.0
108297	3401.115100	100	Stainless steel V4A	115	100	152.0
108298	3401.133100	110-A	Stainless steel V4A	133	100	167.0
108299	3402.3119	25-D	Stainless steel V4A	31	19	74.0
108300	3402.3125	25-D	Stainless steel V4A	31	25	74.0



3401.6625



Storz couplings

stainless steel V4A



3402.6650

Storz coupling with hose stem for safety clamp, swivel type, stainless steel

Art. No.	Type No.	Storz size	Material	Lug distance mm	Hose I.D. mm	Length mm
108301	3402.6638	52-C	Stainless steel V4A	66	38	90.0
108302	3402.6650	52-C	Stainless steel V4A	66	50	95.0
108303	3402.8975	75-B	Stainless steel V4A	89	75	114.0
108304	3402.133100	110-A	Stainless steel V4A	133	100	157.0



3403.66114

Storz fixed coupling, male threaded, stainless steel

Art. No.	Type No.	Storz size	Material	Lug distance mm	Male thread
108305	3403.3134	25-D	Stainless steel V4A	31	G 3/4
108306	3403.3110	25-D	Stainless steel V4A	31	G 1
108307	3403.4410	32	Stainless steel V4A	44	G 1
108308	3403.44114	32	Stainless steel V4A	44	G 1 1/4
108309	3403.51114	38	Stainless steel V4A	51	G 1 1/4
108310	3403.51112	38	Stainless steel V4A	51	G 1 1/2
108311	3403.6610	52-C	Stainless steel V4A	66	G 1
108312	3403.66114	52-C	Stainless steel V4A	66	G 1 1/4
108313	3403.66112	52-C	Stainless steel V4A	66	G 1 1/2
108314	3403.6620	52-C	Stainless steel V4A	66	G 2
108315	3403.8120	65	Stainless steel V4A	81	G 2
108316	3403.81212	65	Stainless steel V4A	81	G 2 1/2
108317	3403.89212	75-B	Stainless steel V4A	89	G 2 1/2
108318	3403.8930	75-B	Stainless steel V4A	89	G 3
108319	3403.11540	100	Stainless steel V4A	115	G 4
108320	3403.13340	110-A	Stainless steel V4A	133	G 4



3404.66112

Storz fixed coupling, female threaded, stainless steel

Art. No.	Type No.	Storz size	Material	Lug distance mm	Female thread
108321	3404.3112	25-D	Stainless steel V4A	31	G 1/2
108322	3404.3134	25-D	Stainless steel V4A	31	G 3/4
108323	3404.3110	25-D	Stainless steel V4A	31	G 1
108324	3404.4410	32	Stainless steel V4A	44	G 1
108325	3404.44114	32	Stainless steel V4A	44	G 1 1/4
108326	3404.51114	38	Stainless steel V4A	51	G 1 1/4
108327	3404.51112	38	Stainless steel V4A	51	G 1 1/2
108328	3404.6610	52-C	Stainless steel V4A	66	G 1
108329	3404.66114	52-C	Stainless steel V4A	66	G 1 1/4
108330	3404.66112	52-C	Stainless steel V4A	66	G 1 1/2
108331	3404.6620	52-C	Stainless steel V4A	66	G 2
108332	3404.66212	52-C	Stainless steel V4A	66	G 2 1/2
108333	3404.8120	65	Stainless steel V4A	81	G 2
108334	3404.81212	65	Stainless steel V4A	81	G 2 1/2
108335	3404.8130	65	Stainless steel V4A	81	G 3
108336	3404.8920	75-B	Stainless steel V4A	89	G 2
108337	3404.89212	75-B	Stainless steel V4A	89	G 2 1/2
108338	3404.8930	75-B	Stainless steel V4A	89	G 3
108339	3404.11540	100	Stainless steel V4A	115	G 4
108340	3404.13340	110-A	Stainless steel V4A	133	G 4

Storz couplings

stainless steel V4A

Storz adapter, stainless steel

Art. No.	Type No.	Storz size	Material	Lug distance 1 mm	Lug distance 2 mm
108341	3405.6631	52-C/25-D	Stainless steel V4A	66	31
108342	3405.8166	65/52-C	Stainless steel V4A	81	66
108343	3405.8966	75-B/52-C	Stainless steel V4A	89	66
108344	3405.8981	75-B/65	Stainless steel V4A	89	81
108345	3405.11589	100/75-B	Stainless steel V4A	115	89
108346	3405.13389	110-A/75-B	Stainless steel V4A	133	89
108347	3405.133115	110-A/100	Stainless steel V4A	133	115



3405.6631

Storz adapter to flange, stainless steel

Art. No.	Type No.	Storz size	Material	Lug distance 1 mm	Flange	Hole circle dia. mm	No. of bolt holes
108348	3406.3125	25-D	Stainless steel V4A	31	DN 25	85	4
108349	3406.6650	52-C	Stainless steel V4A	66	DN 50	125	4
108350	3406.8165	65	Stainless steel V4A	81	DN 65	145	4
108351	3406.8965	75-B	Stainless steel V4A	89	DN 65	145	4
108352	3406.8980	75-B	Stainless steel V4A	89	DN 80	160	8
108353	3406.115100	100	Stainless steel V4A	115	DN 100	180	8
108354	3406.133100	110-A	Stainless steel V4A	133	DN 100	180	8



3406.6650

Storz blank cap with chain, stainless steel

Art. No.	Type No.	Storz size	Material	Lug distance mm
108355	3407.31	25-D	Stainless steel V4A	31
108356	3407.44	32	Stainless steel V4A	44
108357	3407.51	38	Stainless steel V4A	51
108358	3407.66	52-C	Stainless steel V4A	66
108359	3407.81	65	Stainless steel V4A	81
108360	3407.89	75-B	Stainless steel V4A	89
108361	3407.115	100	Stainless steel V4A	115
108362	3407.133	110-A	Stainless steel V4A	133



3407.66



Storz couplings

stainless steel V4A



2408.100



2408.300



2408.400



2408.600



2408.700



3408.51

Jet / spray branch pipe acc. to DIN 14365, aluminium

Art. No.	Type No.	Storz size	Material	Thread	Flow rate at 6 bar l/min	Nozzle
108267	2408.100	25-D	Handle and nozzle: plastic	G 1 ET	26	4 mm
108268	2408.200	52-C	Handle and nozzle: plastic	G 2 ET	132	9 mm
108269	2408.300	52-C	Rubberised handle	G 2 ET	132	9 mm
108270	2408.400	52-C	Rubberised handle with additional water curtain	G 2 ET	132	9 mm
108271	2408.500	75-B	Rubberised handle with additional water curtain	G 2 1/2 ET	418	16 mm

Spanner for Storz couplings

Art. No.	Type No.	For lug distance	Material
108272	2408.600	31	Steel
108273	2408.700	66, 89, 133	Malleable iron

Replacement seal for Storz couplings, FKM

Art. No.	Type No.	Storz size	Material	Lug distance mm
108363	3408.31	25-D	FKM	31
108364	3408.44	32	FKM	44
108365	3408.66	52-C	FKM	66
108366	3408.81	65	FKM	81
108367	3408.89	75-B	FKM	89
108368	3408.115	100	FKM	115
108369	3408.133	110-A	FKM	133
108370	3408.51	38	FKM	51

Coupling sketches

Coupling with male thread

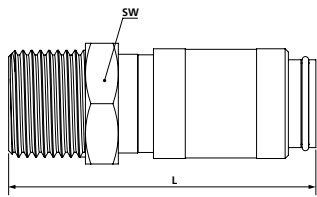

Coupling with female thread

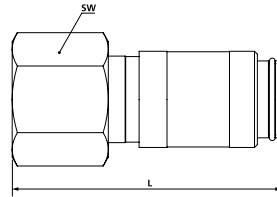

Coupling with hose stem

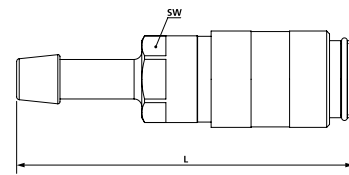

Coupling with hose connection

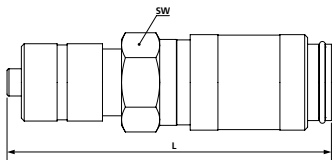

Coupling with hose connection and kink protector spring

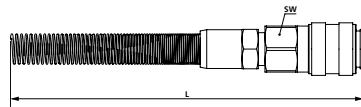

Coupling with hose stem, swivel-type

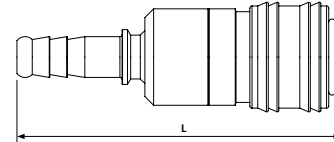

Coupling with push-in fitting

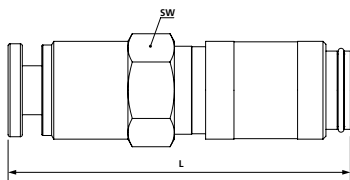

Hydraulic coupling

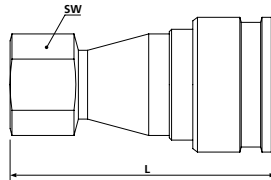

GEKA couplings and claw couplings sketches

Dummy coupling

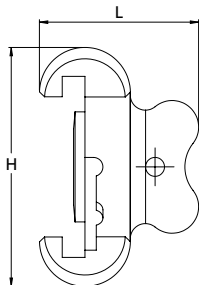

Coupling with male thread

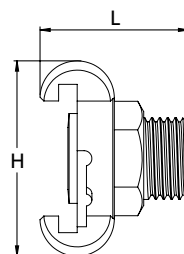

Safety coupling with male thread

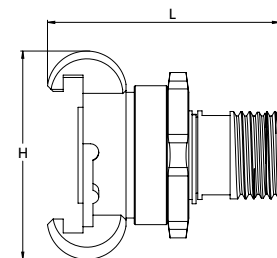

Coupling with female thread

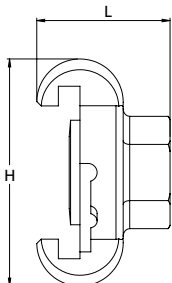

Safety coupling with female thread

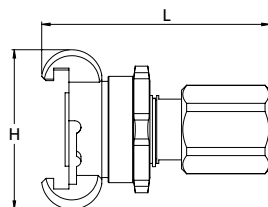

Coupling with hose connection

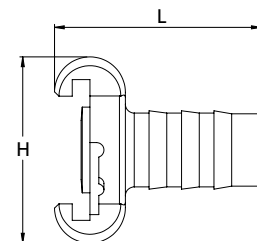

Safety Coupling with hose connection

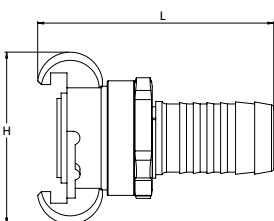

Coupling with hose connection and safety collar

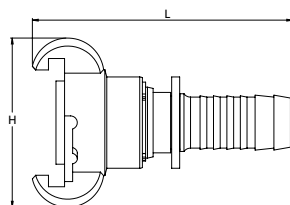

Double plug valve

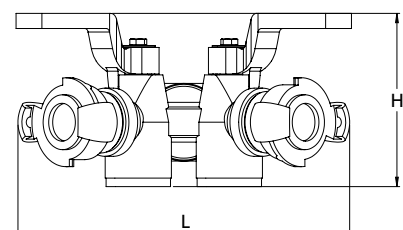

GEKA couplings and claw couplings sketches

Plug valve

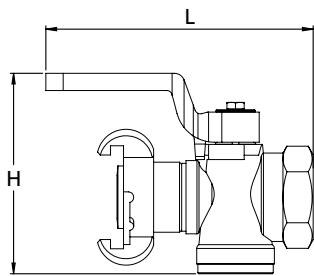

Hose clamb

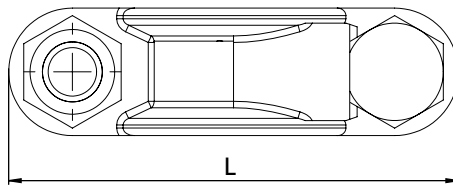

Hose clamb with safety claws

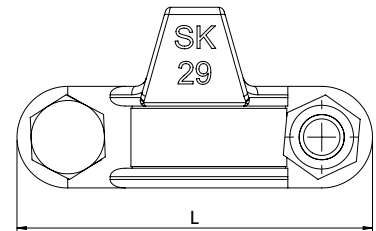

Nipple sketches

Plug with male thread

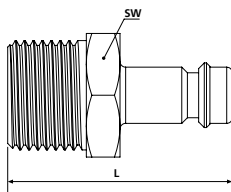

Plug with female thread

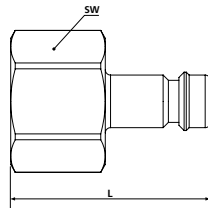

Plug for hose with
kink protector spring

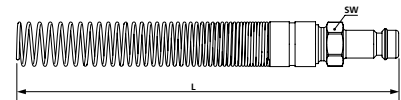

Plug for hose

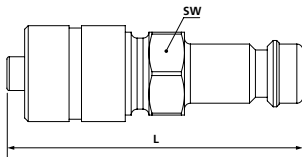

Push-in plug

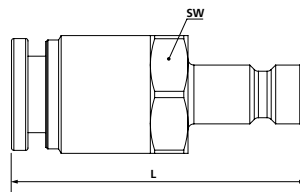

Push-in plug for
hydraulic couplings

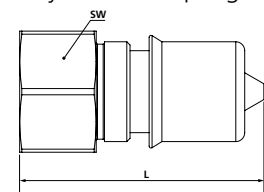

Stem sketches

Hose stem, swivel-type

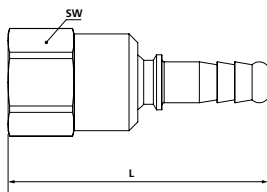

Stem

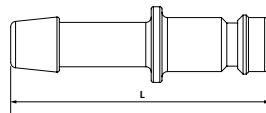

Male hose fitting

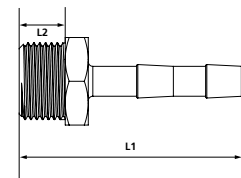

Distributor sketches

Distributor with 2 quick disconnect couplings, male

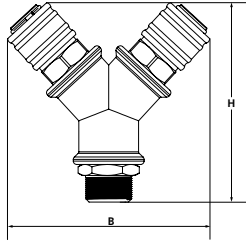

Distributor with 2 quick disconnect couplings, female

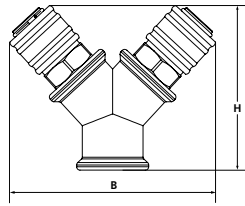

Distributor with 2 quick disconnect couplings with push-in plug

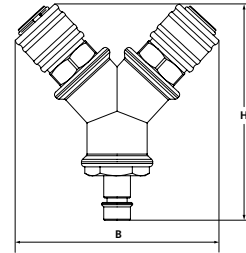

Distributor with 3 quick disconnect couplings, male

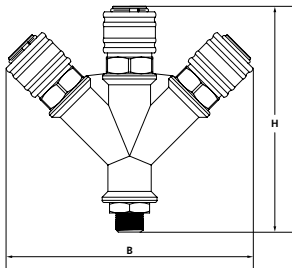

Distributor with 3 quick disconnect couplings, female

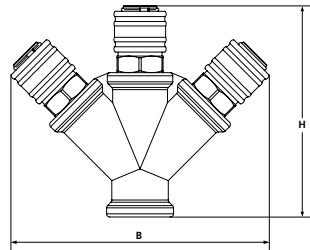

Distributor with 3 quick disconnect couplings with push-in plug

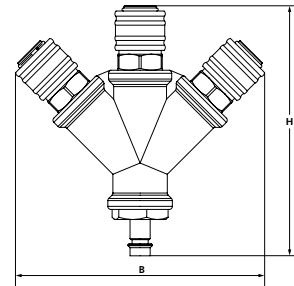

End porting box with couplings

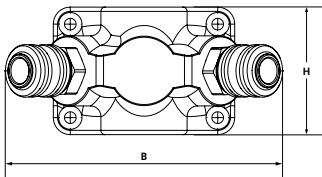

Push-in elbow sketch

Push-in elbow for couplings

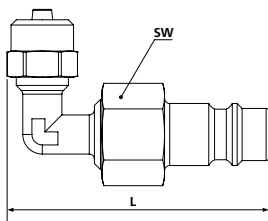



TIGHTER

IS NOT

POSSIBLE.

Push-in fittings



»Blue series« mini,
plastic and nickel-plated brass
Page 594-600



»Blue series«,
plastic and nickel-plated brass
Page 601-633



Boxed sets push-in fittings
»Blue series«
Page 622-623



»Blue series«
Stop valves
Page 634-636



»Blue series«
Non-return valves
Page 637-638



»click-clock« Series,
nickel-plated brass
Page 639-650



Boxed set push-in fittings
»click-clock« Series
Page 648



»metallica« Series,
nickel-plated brass
Page 651-656



Removal tool
for push-in fitting
Page 656



»universal short« series,
nickel-plated brass
Page 657-658



Stainless steel
Page 659-666

Screw fittings



Nickel-plated brass
Page 667-673



Stainless steel 1.4571
Page 674-675



Stainless steel 1.4404
Page 675-677

Tube fittings



Plastic (POM) blue
Page 678-680



Polyamide (PA)
Page 681-684



Polypropylene (PP)
Page 685-687



Perfluoroalkoxy alkane (PFA)
Page 687-689

Tube connectors



Brass and acetal copolymer
(POM)
Page 690-691



Brass and nickel-plated brass
Page 691-693



Polyamid (PA 6)
Page 694-695

Tube connectors



Acetal copolymer (POM)
Page 696-698

Standard screw fittings brass



Double pipe nipples
Page 699



Reducing nipples
Page 700-701



Screw plugs
Page 701-702



Double nipples
Page 703-704



Sockets
Page 705



Male hose fittings
Page 705-707



Female hose fittings
Page 707-708



Bulkhead connectors
Page 708-709



Hose fittings
Page 709



Swivel nuts
Page 710



Standard screw fittings brass



Lock nuts
Page 710



Caps
Page 711



Swivel hose fittings
Page 711



Boxed sets, brass turned parts
Page 712

Standard screw fittings nickel-plated brass



Reducing nipple
Page 713-715



Double nipple
Page 715-716, 718



Screw plugs
Page 717-718



Sockets
Page 719



Male hose fittings
Page 720-722



Female hose fittings
Page 722-723

Standard screw fittings nickel-plated brass



Extensions
Page 723-724



Bulkhead connectors
Page 724



Hose fittings
Page 725



Caps
Page 725



Swivel nuts
Page 726



Lock nuts
Page 726

Standard screw fittings stainless steel 1.4571



Double pipe nipples
Page 727-728



Reducing nipples
Page 728-729



Screw plugs
Page 729-730



Double nipples
Page 730-731

Standard screw fittings stainless steel 1.4571



Bulkhead connectors
Page 731



Swivel nuts
Page 732



Male hose fittings
Page 732-733



Female hose fittings
Page 733



Hose fittings
Page 733



Sockets
Page 734

Standard screw fittings stainless steel 1.4408



Double threaded nipple
Page 735-736, 742-744



Reducing nipple
Page 737



Screw plug
Page 738



Closing cap
Page 739

Standard screw fittings stainless steel 1.4408



Sockets
Page 740



Socket
Page 741



Counter nuts
Page 742



Double nipples
Page 742-744

Bite-type tube fittings



Lightweight series acc.
DIN 2353 nickel-plated brass
Page 745-749



Galvanised steel
acc. DIN 2353
Page 749-760



Stainless steel 1.4571
acc. DIN 2353
Page 761



Stainless steel 1.4571
acc. DIN 2353, adjustable
Page 762-764



Stainless steel 1.4571
acc. DIN 2353, Standard
Page 764-765



Stainless steel 1.4571
Page 766-769

Bite-type tube fittings



Pre-assembly adapters
Page 770



Lubricants
Page 770

Distributors, distributor blocks, distributor pieces



Distributor block
Page 771



Distributor blocks,
aluminium
Page 771-772



Porting boxes
Page 772-773



Distributors, in block shape,
brass
Page 773



Distributors, in block shape,
aluminium
Page 774



Distributor pieces
Page 774



Distributor pipes, brass
Page 775

Fittings



Nickel-plated brass
Page 776-778

Fittings



Brass with a bare metal
surface
Page 778-779



Stainless steel
Page 782-784

Malleable iron fittings zinc plated DIN DVGW



Malleable iron fittings
zinc plated
Page 789-797

Steel fittings



Double pipe nipples,
zinc plated
Page 798-799



Weld-on sleeve,
steel with a bare
metal surface
Page 800

Silencers



Plastic silencers
Page 801-802



Sintered bronze silencers
Page 802-803



Sintered bronze silencers,
flat type
Page 803



Sintered bronze silencers,
adjustable
Page 804



Silencers



High-performance silencers,
aluminium
Page 804



High-performance silencers
Page 805



Sintered bronze silencers
Page 805-806



Sintered bronze silencers,
flat type
Page 806



Sintered bronze silencers,
adjustable
Page 807



Stainless steel silencers
Page 808



Stainless steel silencers,
flat type
Page 808



Stainless steel silencers,
sintered damper element,
adjustable
Page 809

Notes

A large grid of small dots for taking notes, covering most of the page.



		Medium					max. operating pressure [bar]	Temperature range [°C]
Model	Description	Compressed air	Water	Non-toxic and non-aggressive gases and liquids	Oil	Vacuum		
	Quick-connect fittings »Blue Series«	•		•		•	regular: 10 temporary: 15*	-20 to 80
	Quick-connect fittings »click-clock«	•					16	-20 to 80
	Quick-connect fittings »metallica«	•					16	-20 to 150
	Quick-connect fittings »universal short«	•				•	20	-20 to 80
	Quick-connect fittings Stainless Steel	•	•				20	-20 to 150
	Hose screwed fittings	•					0 to 10	-10 to 200
	Standard screw fittings Brass	•	•	•	•		25	max. 150
	Standard screw fittings Nickel-plated brass	•	•	•	•		25	max. 150
	Standard screw fittings Stainless Steel	•	•	•	•		10 to 60	max. 150
	Cutting ring fittings	•	•				max. 60	max. 150
	Connection pieces	•	•				16 to 150	120 to 175
	Malleable cast iron fittings	•	•	•			max. 25	-20 to 300

* except "Blue Series Mini" and stop and check valves

Material											
Thread types	Brass	Brass nickel-plated	Stainless steel	Galvanized steel	Malleable cast iron	Polyamide (PA)	Polypropylene (PP)	Perfluoroalkoxy (PFA)	Acetal copolymer (POM)	Property / Features	From page
M3 to 1/2"		•								easy plugging and loosening behaviour	601
M3 to 1/2"		•								suitable for vacuum	639
M5 to 1/2"		•								resistant at high temperatures thanks to FKM seal	651
1/8" to 1/2"		•								combinable with BSPP, BSPT, NPT, NPTF, PT, PF	657
M5 to 1/2"			•							suitable for the chemical and food sector	659
M10 to 1/2"						•	•	•	•	extremely impact tough, high weather resistance	681
M3 to 3"	•									basic design	700
M3 to 3"		•									713
M5 to 3"			•							especially corrosion resistant	728
M8 to 1 1/2"		•	•	•						high versatility	745
M5 to 2"	•	•	•							standard design	780
1/4" to 3"					•					classic screwed fitting series in pipeline construction	785



Push-in fittings

»blue series« mini

Push-in fittings series manufactured in plastic and nickel-plated brass.
Space-saving miniature design.

Working pressure	-0.95 - 10 bar
Temperature range	0 to 60 °C
Material	Plastic and nickel-plated brass
Sleeve	Plastic
Medium	Compressed air
Recommended hose	PU or PA (nylon)

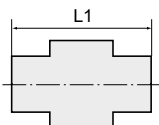

Male connectors, mini

»blue series« mini

EASY



122.018-6M



123.018-4M



PA-54



207.005-4M

Male connector, male thread with outer hex, mini

Art. No.	Type No.	Thread	For tube O.D. mm	L1 mm	a/f mm	Standard thread
148783	122.003-3M	M3	3	15.2	5,5	DIN 13-1, O-ring (NBR)
148784	122.003-4M	M3	4	16.4	8	DIN 13-1, O-ring (NBR)
148785	122.005-3M	M5	3	15.8	8	DIN 13-1, O-ring (NBR)
148786	122.005-4M	M5	4	16.9	8	DIN 13-1, O-ring (NBR)
148787	122.005-6M	M5	6	17.8	10	DIN 13-1, O-ring (NBR)
148788	122.006-3M	M6	3	15.9	9	DIN 13-1, O-ring (NBR)
148789	122.006-4M	M6	4	18.2	9	DIN 13-1, O-ring (NBR)
148790	122.006-6M	M6	6	18.7	10	DIN 13-1, O-ring (NBR)
148791	122.018-4M	G 1/8	4	18.2	10	DIN EN ISO 228-1, O-ring (NBR)
148792	122.018-6M	G 1/8	6	18.3	10	DIN EN ISO 228-1, O-ring (NBR)
148793	123.018-4M	R 1/8	4	18.7	10	ISO 7-1, coated
148794	123.018-6M	R 1/8	6	19.1	10	ISO 7-1, coated

Male connector, female thread with outer hex, mini

Art. No.	Type No.	Thread	For tube O.D. mm	L1 mm	a/f mm	Standard thread
109010	PA-33	M3	3	16.7	8	DIN 13-1
109011	PA-34	M3	4	18.0	8	DIN 13-1
109012	PA-53	M5	3	16.2	8	DIN 13-1
109013	PA-54	M5	4	18.0	8	DIN 13-1

Male connector, round, mini

Art. No.	Type No.	Thread	For tube O.D. mm	L1 mm	Standard thread
148799	207.003-3M	M3	3	14.7	DIN 13-1, O-ring (NBR)
148800	207.003-4M	M3	4	16.3	DIN 13-1, O-ring (NBR)
148801	207.005-3M	M5	3	15.3	DIN 13-1, O-ring (NBR)
148802	207.005-4M	M5	4	16.8	DIN 13-1, O-ring (NBR)
148803	207.005-6M	M5	6	17.7	DIN 13-1, O-ring (NBR)
148804	207.006-3M	M6	3	15.8	DIN 13-1, O-ring (NBR)
148805	207.006-4M	M6	4	18.2	DIN 13-1, O-ring (NBR)
148806	207.006-6M	M6	6	18.7	DIN 13-1, O-ring (NBR)
152274	207.007-4M	M7	4	19.7	DIN 13-1, O-ring (NBR)

Male connectors, mini

»blue series« mini

EASY

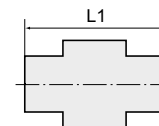

Male connector, round, mini						
Art. No.	Type No.	Thread	For tube O.D. mm	L1 mm		Standard thread
152276	207.007-6M	M7	6	20.2		DIN 13-1, O-ring (NBR)
148809	207.018-4M	G 1/8	4	18.0		DIN EN ISO 228-1, O-ring (NBR)
148810	207.018-6M	G 1/8	6	18.2		DIN EN ISO 228-1, O-ring (NBR)
148811	208.018-4M	R 1/8	4	19.0		ISO 7-1, coated
148812	208.018-6M	R 1/8	6	19.0		ISO 7-1, coated

Male elbows, mini

»blue series« mini

EASY

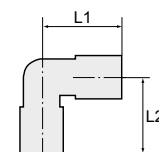

Male elbow, swivel type, mini							
Art. No.	Type No.	Thread	For tube O.D. mm	L1 mm	L2 mm	a/f mm	Standard thread
148813	125.003-3M	M3	3	11.1	12.7	5,5	DIN 13-1, O-ring (NBR)
148814	125.003-4M	M3	4	16.0	14.6	8	DIN 13-1, O-ring (NBR)
148815	125.005-3M	M5	3	11.1	15.7	8	DIN 13-1, O-ring (NBR)
148816	125.005-4M	M5	4	16.0	15.6	8	DIN 13-1, O-ring (NBR)
148817	125.005-6M	M5	6	16.7	16.3	8	DIN 13-1, O-ring (NBR)
148818	125.006-3M	M6	3	11.1	16.7	9	DIN 13-1, O-ring (NBR)
148819	125.006-4M	M6	4	16.0	16.6	9	DIN 13-1, O-ring (NBR)
148820	125.006-6M	M6	6	16.7	17.3	9	DIN 13-1, O-ring (NBR)
109036	PL-74	M7	4	14.0	15.7	10	DIN 13-1, O-ring (NBR)
109037	PL-76	M7	6	16.3	17.2	10	DIN 13-1, O-ring (NBR)
148823	125.018-4M	G 1/8	4	16.0	17.4	10	DIN EN ISO 228-1, O-ring (NBR)
148824	125.018-6M	G 1/8	6	16.7	18.3	10	DIN EN ISO 228-1, O-ring (NBR)
148825	126.018-4M	R 1/8	4	16.0	17.4	10	ISO 7-1, coated
148826	126.018-6M	R 1/8	6	16.7	19.0	10	ISO 7-1, coated



125.006-4M



PL-74

Male elbow, long, swivel type, mini							
Art. No.	Type No.	Thread	For tube O.D. mm	L1 mm	L2 mm	a/f mm	Standard thread
148827	127.003-3M	M3	3	11.4	19.9	5,5	DIN 13-1, NBR O-ring
148828	127.003-4M	M3	4	16.3	23.4	8	DIN 13-1, NBR O-ring
148829	127.005-3M	M5	3	11.4	26.4	8	DIN 13-1, NBR O-ring
148830	127.005-4M	M5	4	16.3	26.3	8	DIN 13-1, NBR O-ring
148831	127.005-6M	M5	6	17.0	27.7	8	DIN 13-1, NBR O-ring
148832	127.006-3M	M6	3	11.4	27.7	9	DIN 13-1, NBR O-ring
148833	127.006-4M	M6	4	16.1	27.7	9	DIN 13-1, NBR O-ring
148834	127.006-6M	M6	6	16.4	29.0	9	DIN 13-1, NBR O-ring
148835	127.018-4M	G 1/8	4	15.9	29.4	10	DIN EN ISO 228-1, NBR O-ring
148836	127.018-6M	G 1/8	6	16.4	31.0	10	DIN EN ISO 228-1, NBR O-ring
148837	128.018-4M	R 1/8	4	15.9	29.1	10	ISO 7-1, coated
148838	128.018-6M	R 1/8	6	16.4	30.5	10	ISO 7-1, coated



127.005-4M



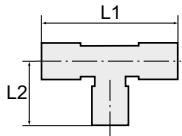

Male branch tees, mini

»blue series« mini

EASY



131.005-4M

Male branch tee, swivel type, mini

Art. No.	Type No.	Thread	For tube O.D. mm	L1 mm	L2 mm	a/f mm	Standard thread
148839	131.003-3M	M3	3	22.8	12.8	5,5	DIN 13-1, O-ring (NBR)
148840	131.003-4M	M3	4	29.1	15.3	8	DIN 13-1, O-ring (NBR)
148841	131.005-3M	M5	3	22.8	14.2	8	DIN 13-1, O-ring (NBR)
148842	131.005-4M	M5	4	29.1	15.8	8	DIN 13-1, O-ring (NBR)
148843	131.005-6M	M5	6	32.8	17.0	8	DIN 13-1, O-ring (NBR)
148844	131.006-3M	M6	3	22.8	15.1	9	DIN 13-1, O-ring (NBR)
148845	131.006-4M	M6	4	29.4	16.8	9	DIN 13-1, O-ring (NBR)
148846	131.006-6M	M6	6	32.8	18.0	9	DIN 13-1, O-ring (NBR)
148847	131.018-4M	G 1/8	4	29.4	18.6	10	DIN EN ISO 228-1, O-ring (NBR)
148848	131.018-6M	G 1/8	6	32.8	19.8	10	DIN EN ISO 228-1, O-ring (NBR)
148849	132.018-4M	R 1/8	4	29.4	19.1	10	ISO 7-1, coated
148850	132.018-6M	R 1/8	6	32.8	19.8	10	ISO 7-1, coated

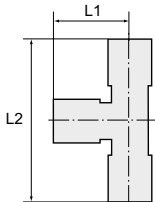

Male branch tees, angled plug connections, mini

»blue series« mini

EASY



129.005-6M

Male branch tee, angled plug connections, swivel type, mini

Art. No.	Type No.	Thread	For tube O.D. mm	L1 mm	L2 mm	a/f mm	Standard thread
148851	129.003-3M	M3	3	11.4	24.5	5,5	DIN 13-1, O-ring (NBR)
148852	129.003-4M	M3	4	14.7	30.1	8	DIN 13-1, O-ring (NBR)
148853	129.005-3M	M5	3	11.4	25.5	8	DIN 13-1, O-ring (NBR)
148854	129.005-4M	M5	4	14.7	30.1	8	DIN 13-1, O-ring (NBR)
148855	129.005-6M	M5	6	16.4	33.3	8	DIN 13-1, O-ring (NBR)
148856	129.006-3M	M6	3	11.4	26.2	9	DIN 13-1, O-ring (NBR)
148857	129.006-4M	M6	4	14.7	31.8	9	DIN 13-1, O-ring (NBR)
148858	129.006-6M	M6	6	16.4	34.0	9	DIN 13-1, O-ring (NBR)
148859	129.018-4M	G 1/8	4	14.7	33.3	10	DIN EN ISO 228-1, O-ring (NBR)
148860	129.018-6M	G 1/8	6	16.4	36.4	10	DIN EN ISO 228-1, O-ring (NBR)
148861	130.018-4M	R 1/8	4	14.7	33.3	10	ISO 7-1, coated
148862	130.018-6M	R 1/8	6	16.4	36.2	10	ISO 7-1, coated

Unions, mini

»blue series« mini

EASY

Union, mini				
Art. No.	Type No.	For tube O.D. mm	L1 mm	
148863	135.003M	3	19.8	
148864	135.004M	4	25.2	
148865	135.006M	6	26.3	

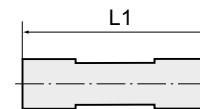

135.004M

Reducer, mini				
Art. No.	Type No.	For tube O.D. mm	L1 mm	
148866	136.0403M	4/3	24.9	
148867	136.0604M	6/4	26.1	



136.0403M

Bulkhead connectors, mini

»blue series« mini

EASY

Bulkhead connector, mini						
Art. No.	Type No.	Thread	For tube O.D. mm	L1 mm	a/f mm	
148868	149.008-3M	M8x0.75	3	22.0	10	
148869	149.010-4M	M10x1.0	4	25.2	12	
148870	149.012-3M	M12x1.0	6	26.9	14	

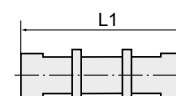

149.012-3M

Union elbows, mini

»blue series« mini

EASY

Union elbow, mini				
Art. No.	Type No.	For tube O.D. mm	L1 mm	
148871	137.003M	3	11.4	
148872	137.004M	4	14.6	
148873	137.006M	6	16.2	

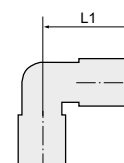

137.004M

Bulkhead connectors, elbow type, mini

»blue series« mini

EASY

Bulkhead connector, elbow type, mini							
Art. No.	Type No.	Thread	For tube O.D. mm	L1 mm	L2 mm	a/f mm	
109089	PWS-83	M8x0.75	3	12.0	21.6	10	
109090	PWS-104	M10x1.0	4	15.7	22.5	12	
109091	PWS-126	M12x1.0	6	16.0	28.8	12	

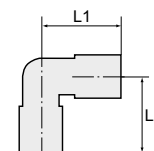

PWS-126

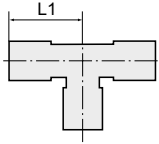

Union tees, mini

»blue series« mini

EASY



138.004M



138.0604M

Union tee, mini

Art. No.	Type No.	For tube O.D. mm	L1 mm
148877	138.003M	3	11.4
148878	138.004M	4	14.6
148879	138.006M	6	16.4

Union tee, unequal, mini

Art. No.	Type No.	For tube O.D. mm	L1 mm
148880	138.0403M	4/3	14.7
148881	138.0604M	6/4	16.4

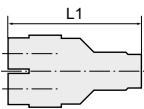

Y unions, mini

»blue series« mini

EASY



140.003M



141.0403M

Y union, mini

Art. No.	Type No.	For tube O.D. mm	L1 mm
148882	140.003M	3	28.8
148883	140.004M	4	29.2
148884	140.006M	6	31.8

Y union, unequal, mini

Art. No.	Type No.	For tube O.D. mm	L1 mm
148885	141.0403M	4/3	29.1
148886	141.0604M	6/4	31.6

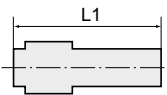

Reducers with push-in plug, mini

»blue series« mini

EASY



PSR-43

Reducer with push-in plug, mini

Art. No.	Type No.	Plug connection mm	For tube O.D. mm	L1 mm	Material
109102	PSR-43	4	3	28.8	Nickel-plated brass
109103	PSR-64	6	4	32.2	Nickel-plated brass

Union elbows with push-in plug, mini

»blue series« mini

EASY

Union elbow with push-in plug, mini

Art. No.	Type No.	Plug connection mm	For tube O.D. mm	L1 mm	L2 mm
109104	PLS-33	3	3	11.5	26.6
109105	PLS-44	4	4	14.0	28.5
109106	PLS-66	6	6	16.3	32.0

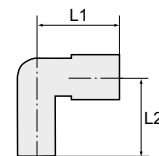

PLS-66

Y unions with push-in plug, mini

»blue series« mini

EASY

Y union with push-in plug, mini

Art. No.	Type No.	Plug connection mm	For tube O.D. mm	L1 mm
109107	PYS-3	3	3	38.0
109108	PYS-4	4	4	43.0
109109	PYS-6	6	6	46.0

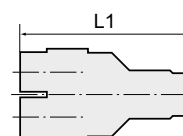

PYS-6

Y union with push-in plug, unequal, mini

Art. No.	Type No.	Plug connection mm	For tube O.D. mm	L1 mm
109110	PYSR-43	4	3	40.5
109111	PYSR-64	6	4	43.5



PYSR-64

Unidirectional flow control valves with outgoing air restriction, angled, mini

»blue series« mini

EASY

Unidirectional flow control valve with outgoing air restriction, adjustable with knurled screw, angled, swivel type, metric male thread with O-ring (NBR), mini

Art. No.	Type No.	Thread	For tube O.D. mm	L1 mm	L2 mm	a/f mm
135554	283.003-3	M3	3	31.2	16.4	8
135555	283.003-4	M3	4	31.2	16.7	8
135556	283.003-6	M3	6	31.2	18.1	8
135557	283.005-3	M5	3	31.7	16.4	8
135558	283.005-4	M5	4	31.7	16.7	8
135559	283.005-6	M5	6	31.7	18.1	8

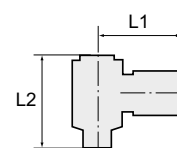
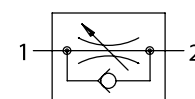

283.003-3



6

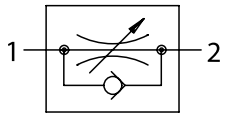

Unidirectional flow control valves with incoming air restriction, angled, mini

»blue series« mini

EASY

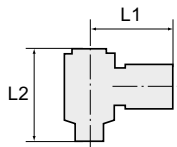

282.003-3

Unidirectional flow control valve with incoming air restriction, adjustable with knurled screw, angled, swivel type, metric male thread with O-ring (NBR), mini

Art. No.	Type No.	Thread	For tube O.D. mm	L1 mm	L2 mm	a/f mm
135548	282.003-3	M3	3	31.2	16.4	8
135549	282.003-4	M3	4	31.2	16.7	8
135550	282.003-6	M3	6	31.2	18.1	8
135551	282.005-3	M5	3	31.7	16.4	8
135552	282.005-4	M5	4	31.7	16.7	8
135553	282.005-6	M5	6	31.7	18.1	8

Push-in fittings

»blue series«

Push-in fittings series manufactured in plastic and nickel-plated brass. All parts are suitable for use with hoses, tubes or pipes made of plastic and copper.

Working pressure	-0.95 - 10 bar
Max. working pressure short term	15 bar*
Temperature range	-20 to 80 °C
Material	Plastic and nickel-plated brass
Sleeve	Plastic
Medium	Compressed air, neutral and safe gases and liquids
Recommended hose	PU or PA (nylon)

* The suitability test for the individual application is the user's responsibility.

Male connectors

»blue series«

EASY

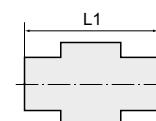

Male connector, parallel male thread with O-ring (NBR) and outer hex

Art. No.	Type No.	Thread	For tube O.D. mm	L1 mm	Hexagon socket head mm	a/f mm
109112	122.005-4	M5	4	20.8	2	10
109113	122.005-6	M5	6	22.2	2	12
109114	122.018-4	G 1/8	4	19.3	3	10
109115	122.018-6	G 1/8	6	20.2	4	12
109116	122.018-8	G 1/8	8	27.1	5	14
109117	122.018-10	G 1/8	10	28.9	5	17
109118	122.018-12	G 1/8	12	31.6	5	21
109119	122.014-4	G 1/4	4	17.4	3	10
109120	122.014-6	G 1/4	6	20.9	4	12
109121	122.014-8	G 1/4	8	23.0	6	14
109122	122.014-10	G 1/4	10	29.9	6	17
109123	122.014-12	G 1/4	12	32.6	6	21
109124	122.038-6	G 3/8	6	19.5	4	12
109125	122.038-8	G 3/8	8	22.1	6	14
109126	122.038-10	G 3/8	10	25.9	8	17
109127	122.038-12	G 3/8	12	28.6	8	21
135627	122.038-14	G 3/8	14	34.9	8	22
109128	122.038-16	G 3/8	16	36.1	8	24
109129	122.012-6	G 1/2	6	22.6	4	12
109130	122.012-8	G 1/2	8	23.2	6	14
109131	122.012-10	G 1/2	10	24.5	8	17
109132	122.012-12	G 1/2	12	31.1	8	21
135628	122.012-14	G 1/2	14	34.9	10	24
109133	122.012-16	G 1/2	16	38.1	10	24



122.014-10

Male connector, conical male thread, coated with outer hex

Art. No.	Type No.	Thread	For tube O.D. mm	L1 mm	Hexagon socket head mm	a/f mm
109134	123.018-4	R 1/8	4	19.8	3	10
109135	123.018-6	R 1/8	6	20.7	4	12
109136	123.018-8	R 1/8	8	27.1	5	14
109137	123.018-10	R 1/8	10	29.6	5	17
109138	123.018-12	R 1/8	12	31.6	5	21
109139	123.014-4	R 1/4	4	17.9	3	14
109140	123.014-6	R 1/4	6	22.5	4	14
109141	123.014-8	R 1/4	8	24.6	5	14
109142	123.014-10	R 1/4	10	30.9	6	17
109143	123.014-12	R 1/4	12	33.6	6	21
109144	123.038-6	R 3/8	6	20.1	4	17
109145	123.038-8	R 3/8	8	24.6	6	17



123.014-10



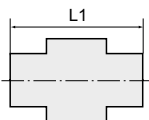

Male connectors

»blue series«

EASY



123.014-10

Male connector, conical male thread, coated with outer hex

Art. No.	Type No.	Thread	For tube O.D. mm	L1 mm	Hexagon socket head mm	a/f mm
109146	123.038-10	R 3/8	10	26.9	8	17
109147	123.038-12	R 3/8	12	29.6	8	21
135629	123.038-14	R 3/8	14	36.9	8	22
109148	123.038-16	R 3/8	16	38.1	8	24
109149	123.012-6	R 1/2	6	24.1	4	21
109150	123.012-8	R 1/2	8	25.6	6	21
109151	123.012-10	R 1/2	10	25.3	8	21
109152	123.012-12	R 1/2	12	32.6	8	21
135630	123.012-14	R 1/2	14	33.9	10	22
109153	123.012-16	R 1/2	16	35.1	10	24

Male connectors, round

»blue series«

EASY



207.018-10

Male connector, round, parallel male thread with O-ring (NBR) and inner hex

Art. No.	Type No.	Thread	For tube O.D. mm	L1 mm	Hexagon socket head mm
109154	207.005-4	M5	4	20.8	2
109155	207.005-6	M5	6	22.4	2
109156	207.018-4	G 1/8	4	19.3	3
109157	207.018-6	G 1/8	6	20.2	4
109158	207.018-8	G 1/8	8	27.0	5
109159	207.018-10	G 1/8	10	28.9	5
109160	207.018-12	G 1/8	12	31.6	5
109161	207.014-4	G 1/4	4	18.0	3
109162	207.014-6	G 1/4	6	20.9	4
109163	207.014-8	G 1/4	8	23.0	5
109164	207.014-10	G 1/4	10	29.9	6
109165	207.014-12	G 1/4	12	32.6	6
109166	207.038-6	G 3/8	6	19.5	4
109167	207.038-8	G 3/8	8	22.1	6
109168	207.038-10	G 3/8	10	25.9	8
109169	207.038-12	G 3/8	12	28.6	8
135631	207.038-14	G 3/8	14	35.0	8
109170	207.038-16	G 3/8	16	35.1	8
109171	207.012-8	G 1/2	8	24.1	6
109172	207.012-10	G 1/2	10	25.3	8
109173	207.012-12	G 1/2	12	31.1	8
135632	207.012-14	G 1/2	14	35.0	10
109174	207.012-16	G 1/2	16	38.1	10

Male connector, round, conical male thread, coated with inner hex

Art. No.	Type No.	Thread	For tube O.D. mm	L1 mm	Hexagon socket head mm
109175	208.018-4	R 1/8	4	19.8	3
109176	208.018-6	R 1/8	6	20.7	4
109177	208.018-8	R 1/8	8	27.1	5
109178	208.018-10	R 1/8	10	29.6	5
109179	208.014-4	R 1/4	4	17.9	3

Male connectors, round

»blue series«

EASY

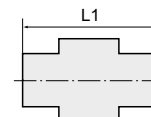

208.018-10

Male connector, round, conical male thread, coated with inner hex					
Art. No.	Type No.	Thread	For tube O.D. mm	L1 mm	Hexagon socket head mm
109180	208.014-6	R 1/4	6	22.5	4
109181	208.014-8	R 1/4	8	24.6	5
109182	208.014-10	R 1/4	10	30.9	6
109183	208.038-6	R 3/8	6	20.1	4
109184	208.038-8	R 3/8	8	24.6	6
109185	208.038-10	R 3/8	10	26.9	8
109186	208.038-12	R 3/8	12	29.6	8
135633	208.038-14	R 3/8	14	37.0	8
109187	208.038-16	R 3/8	16	38.1	8
109188	208.012-6	R 1/2	6	24.1	4
109189	208.012-8	R 1/2	8	25.6	6
109190	208.012-10	R 1/2	10	25.3	8
109191	208.012-12	R 1/2	12	32.6	8
135634	208.012-14	R 1/2	14	34.0	10
109192	208.012-16	R 1/2	16	35.1	10

Female connectors

»blue series«

EASY

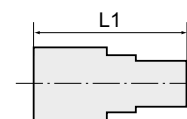

124.014-8

Female connector, parallel female thread with outer hex						
Art. No.	Type No.	Thread	For tube O.D. mm	L1 mm	a/f mm	
109193	124.005-4	M5	4	21.3	10	
109194	124.005-6	M5	6	22.2	12	
109195	124.018-4	G 1/8	4	23.8	14	
109196	124.018-6	G 1/8	6	25.2	14	
109197	124.018-8	G 1/8	8	27.1	14	
109198	124.018-10	G 1/8	10	28.5	14	
109199	124.014-4	G 1/4	4	26.8	17	
109200	124.014-6	G 1/4	6	28.2	17	
109201	124.014-8	G 1/4	8	30.1	17	
109202	124.014-10	G 1/4	10	32.2	17	
109203	124.014-12	G 1/4	12	34.6	21	
109204	124.038-6	G 3/8	6	29.2	21	
109205	124.038-8	G 3/8	8	31.1	21	
109206	124.038-10	G 3/8	10	33.4	21	
109207	124.038-12	G 3/8	12	35.6	21	
135635	124.038-14	G 3/8	14	37.5	22	
135636	124.038-16	G 3/8	16	38.5	24	
109208	124.012-6	G 1/2	6	31.2	24	
109209	124.012-8	G 1/2	8	33.1	24	
109210	124.012-10	G 1/2	10	35.2	24	
109211	124.012-12	G 1/2	12	37.6	24	
135637	124.012-14	G 1/2	14	39.5	24	
109212	124.012-16	G 1/2	16	39.7	24	



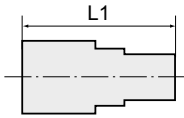

Male bulkhead connectors

»blue series«

EASY



151.014-6

Male bulkhead connector, conical female thread

Art. No.	Type No.	Thread for panel mounting	Thread	For tube O.D. mm	L1 mm	a/f mm
109213	151.018-4	M12x1.0	Rc 1/8	4	23.8	14
109214	151.018-6	M14x1.0	Rc 1/8	6	27.0	17
109215	151.018-8	M16x1.0	Rc 1/8	8	32.1	19
109216	151.014-6	M14x1.0	Rc 1/4	6	30.0	17
109217	151.014-8	M16x1.0	Rc 1/4	8	35.1	19
109218	151.014-10	M20x1.0	Rc 1/4	10	36.0	24
109219	151.014-12	M22x1.0	Rc 1/4	12	38.1	24
109220	151.038-10	M20x1.0	Rc 3/8	10	37.0	24
109221	151.038-12	M22x1.0	Rc 3/8	12	39.1	24
109222	151.012-12	M22x1.0	Rc 1/2	12	41.1	24

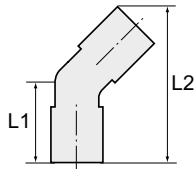

45° union elbows

»blue series«

EASY



167.014-6

45° union elbow, swivel type, parallel male thread with O-ring (NBR)

Art. No.	Type No.	Thread	For tube O.D. mm	L1 mm	L2 mm	a/f mm
109223	167.005-4	M5	4	20.2	34.7	10
109224	167.005-6	M5	6	21.9	36.1	12
109225	167.018-4	G 1/8	4	23.2	39.0	12
109226	167.018-6	G 1/8	6	24.4	42.0	14
109227	167.018-8	G 1/8	8	27.1	47.5	14
109228	167.018-10	G 1/8	10	29.7	53.1	17
109229	167.014-4	G 1/4	4	24.7	40.5	12
109230	167.014-6	G 1/4	6	25.9	43.5	14
109231	167.014-8	G 1/4	8	28.6	49.0	17
109232	167.014-10	G 1/4	10	30.7	54.1	17
109233	167.014-12	G 1/4	12	32.8	60.4	21
109234	167.038-6	G 3/8	6	26.2	45.0	14
109235	167.038-8	G 3/8	8	30.1	50.5	20
109236	167.038-10	G 3/8	10	32.2	55.6	20
109237	167.038-12	G 3/8	12	33.8	61.4	21
109238	167.012-6	G 1/2	6	30.9	48.5	14
109239	167.012-8	G 1/2	8	33.6	54.0	24
109240	167.012-10	G 1/2	10	35.7	59.1	19
109241	167.012-12	G 1/2	12	37.3	64.9	24

45° union elbow, swivel type, conical male thread, coated

Art. No.	Type No.	Thread	For tube O.D. mm	L1 mm	L2 mm	a/f mm
109242	154.018-4	R 1/8	4	22.7	38.5	10
109243	154.018-6	R 1/8	6	24.4	42.0	12
109244	154.018-8	R 1/8	8	27.6	48.0	14
109245	154.018-10	R 1/8	10	30.2	53.6	17
109246	154.014-4	R 1/4	4	25.7	41.5	14
109247	154.014-6	R 1/4	6	26.9	44.5	14
109248	154.014-8	R 1/4	8	29.6	50.0	14
109249	154.014-10	R 1/4	10	32.2	55.6	17
109250	154.014-12	R 1/4	12	35.2	61.9	21
109251	154.038-6	R 3/8	6	28.4	46.0	17
109252	154.038-8	R 3/8	8	31.1	51.5	17



154.014-6

45° union elbows

»blue series«

EASY

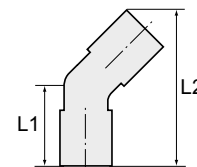

45° union elbow, swivel type, conical male thread, coated						
Art. No.	Type No.	Thread	For tube O.D. mm	L1 mm	L2 mm	a/f mm
109253	154.038-10	R 3/8	10	33.2	56.6	17
109254	154.038-12	R 3/8	12	36.2	62.9	21
109255	154.012-6	R 1/2	6	31.9	49.5	21
109256	154.012-8	R 1/2	8	34.6	55.0	21
109257	154.012-10	R 1/2	10	36.7	60.1	21
109258	154.012-12	R 1/2	12	39.2	65.9	21

Male elbows

»blue series«

EASY

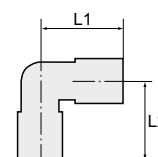

Male elbow, swivel type, parallel male thread with O-ring (NBR)						
Art. No.	Type No.	Thread	For tube O.D. mm	L1 mm	L2 mm	a/f mm
109259	125.005-4	M5	4	18.8	18.6	8
109260	125.005-6	M5	6	20.1	19.6	8
109261	125.018-4	G 1/8	4	18.8	17.5	10
109262	125.018-6	G 1/8	6	20.0	18.5	10
109263	125.018-8	G 1/8	8	22.5	22.0	14
109264	125.018-10	G 1/8	10	26.9	23.3	17
109265	125.014-4	G 1/4	4	18.8	19.0	10
109266	125.014-6	G 1/4	6	20.0	20.0	10
109267	125.014-8	G 1/4	8	22.5	20.5	12
109268	125.014-10	G 1/4	10	26.9	24.3	17
109269	125.014-12	G 1/4	12	28.5	25.8	17
109270	125.038-6	G 3/8	6	20.0	21.1	12
109271	125.038-8	G 3/8	8	22.5	21.6	12
109272	125.038-10	G 3/8	10	26.9	22.8	20
109273	125.038-12	G 3/8	12	28.5	24.3	20
135638	125.038-14	G 3/8	14	33.3	31.7	20
109274	125.038-16	G 3/8	16	33.5	32.3	20
109275	125.012-6	G 1/2	6	20.0	23.5	12
109276	125.012-8	G 1/2	8	22.5	24.0	14
109277	125.012-10	G 1/2	10	26.9	25.7	17
109278	125.012-12	G 1/2	12	28.5	27.2	17
135639	125.012-14	G 1/2	14	33.3	29.9	24
109279	125.012-16	G 1/2	16	33.5	29.9	24



Male elbow, swivel type, conical male thread, coated						
Art. No.	Type No.	Thread	For tube O.D. mm	L1 mm	L2 mm	a/f mm
109280	126.018-4	R 1/8	4	18.8	18.5	10
109281	126.018-6	R 1/8	6	20.1	19.5	10
109282	126.018-8	R 1/8	8	22.5	22.9	10
109283	126.014-4	R 1/4	4	18.8	20.0	14
109284	126.014-6	R 1/4	6	20.1	21.0	14
109285	126.014-8	R 1/4	8	22.5	21.5	14
109286	126.014-10	R 1/4	10	26.9	26.3	17
109287	126.014-12	R 1/4	12	28.4	27.8	17
109288	126.038-6	R 3/8	6	20.1	22.5	17
109289	126.038-8	R 3/8	8	22.5	23.0	17



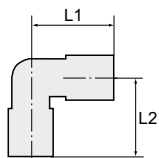

Male elbows

»blue series«

EASY



126.038-10

Male elbow, swivel type, conical male thread, coated

Art. No.	Type No.	Thread	For tube O.D. mm	L1 mm	L2 mm	a/f mm
109290	126.038-10	R 3/8	10	26.9	24.8	17
109291	126.038-12	R 3/8	12	28.4	26.3	17
135640	126.038-14	R 3/8	14	33.3	33.7	20
109292	126.038-16	R 3/8	16	33.5	33.7	20
109293	126.012-6	R 1/2	6	20.1	25.5	21
109294	126.012-8	R 1/2	8	22.5	26.0	21
109295	126.012-10	R 1/2	10	26.9	27.8	21
109296	126.012-12	R 1/2	12	28.4	29.3	21
135641	126.012-14	R 1/2	14	33.3	36.7	21
109297	126.012-16	R 1/2	16	33.5	36.7	21

Male elbows, long

»blue series«

EASY



127.018-6

Male elbow, long, swivel type, parallel male thread with O-ring (NBR)

Art. No.	Type No.	Thread	For tube O.D. mm	L1 mm	L2 mm	a/f mm
109298	127.005-4	M5	4	18.8	32.5	8
109299	127.005-6	M5	6	20.0	33.5	8
109300	127.018-4	G 1/8	4	18.8	30.5	14
109301	127.018-6	G 1/8	6	20.0	31.5	14
109302	127.018-8	G 1/8	8	22.5	37.8	14
109303	127.018-10	G 1/8	10	26.9	45.4	17
109304	127.018-12	G 1/8	12	28.5	46.9	17
109305	127.014-4	G 1/4	4	18.8	30.5	17
109306	127.014-6	G 1/4	6	20.0	31.5	17
109307	127.014-8	G 1/4	8	22.5	33.8	17
109308	127.014-10	G 1/4	10	26.9	46.4	17
109309	127.014-12	G 1/4	12	28.5	47.9	17
109310	127.038-6	G 3/8	6	20.0	32.6	20
109311	127.038-8	G 3/8	8	22.5	34.9	20
109312	127.038-10	G 3/8	10	26.9	43.4	20
109313	127.038-12	G 3/8	12	28.5	49.9	20
135642	127.038-14	G 3/8	14	33.3	58.2	20
109314	127.038-16	G 3/8	16	33.5	58.2	20
109315	127.012-6	G 1/2	6	20.0	35.0	24
109316	127.012-8	G 1/2	8	22.5	37.3	24
109317	127.012-10	G 1/2	10	26.9	45.3	24
109318	127.012-12	G 1/2	12	28.5	46.8	24
135643	127.012-14	G 1/2	14	33.3	56.4	24
109319	127.012-16	G 1/2	16	33.5	54.9	24

Male elbow, long, swivel type, conical male thread, coated

Art. No.	Type No.	Thread	For tube O.D. mm	L1 mm	L2 mm	a/f mm
109320	128.018-4	R 1/8	4	18.8	32.5	10
109321	128.018-6	R 1/8	6	20.0	33.5	10
109322	128.018-8	R 1/8	8	22.5	38.5	10
109323	128.018-10	R 1/8	10	26.9	46.5	17
109324	128.018-12	R 1/8	12	28.5	48.0	17

Male elbows, long

»blue series«

EASY

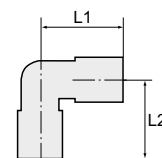

128.018-6

Male elbow, long, swivel type, conical male thread, coated						
Art. No.	Type No.	Thread	For tube O.D. mm	L1 mm	L2 mm	a/f mm
109325	128.014-4	R 1/4	4	18.8	34.0	14
109326	128.014-6	R 1/4	6	20.0	35.0	14
109327	128.014-8	R 1/4	8	22.5	37.5	14
109328	128.014-10	R 1/4	10	26.9	48.5	17
109329	128.014-12	R 1/4	12	28.5	50.0	17
109330	128.038-6	R 3/8	6	20.0	36.5	17
109331	128.038-8	R 3/8	8	22.5	39.0	17
109332	128.038-10	R 3/8	10	26.9	47.0	17
109333	128.038-12	R 3/8	12	28.5	48.5	17
135644	128.038-14	R 3/8	14	33.3	60.2	20
109334	128.038-16	R 3/8	16	33.5	61.0	20
109335	128.012-6	R 1/2	6	20.0	39.5	21
109336	128.012-8	R 1/2	8	22.5	42.0	21
109337	128.012-10	R 1/2	10	26.9	50.0	21
109338	128.012-12	R 1/2	12	28.5	51.5	21
135645	128.012-14	R 1/2	14	33.3	63.2	21
109339	128.012-16	R 1/2	16	33.5	63.5	21

Union elbows with female thread

»blue series«

EASY

Banjo elbow with parallel female thread, swivel type						
Art. No.	Type No.	Thread	For tube O.D. mm	L1 mm	L2 mm	a/f mm
109340	168.005-4	M5	4	17.5	18.5	10
109341	168.005-6	M5	6	18.7	19.7	12
109342	168.018-4	G 1/8	4	17.7	23.0	14
109343	168.018-6	G 1/8	6	18.7	24.4	14
109344	168.018-8	G 1/8	8	22.5	27.3	14
109345	168.018-10	G 1/8	10	27.2	27.3	17
109346	168.014-4	G 1/4	4	17.5	26.0	17
109347	168.014-6	G 1/4	6	18.7	27.4	17
109348	168.014-8	G 1/4	8	22.5	30.3	17
109349	168.014-10	G 1/4	10	27.2	34.3	17
109350	168.014-12	G 1/4	12	29.3	37.0	21
109351	168.038-6	G 3/8	6	18.7	28.7	21
109352	168.038-8	G 3/8	8	22.5	32.0	21
109353	168.038-10	G 3/8	10	27.2	36.3	21
109354	168.038-12	G 3/8	12	29.3	38.0	21
109355	168.038-16	G 3/8	16	32.5	40.5	24
109356	168.012-6	G 1/2	6	18.7	34.2	24
109357	168.012-8	G 1/2	8	22.5	34.3	24
109358	168.012-10	G 1/2	10	27.2	38.8	24
109359	168.012-12	G 1/2	12	29.3	40.5	24
109360	168.012-16	G 1/2	16	32.5	43.0	24



168.014-6



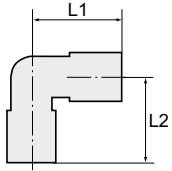

Union elbows with female thread

»blue series«

EASY



153.014-6

Banjo elbow with conical female thread, swivel type

Art. No.	Type No.	Thread	For tube O.D. mm	L1 mm	L2 mm	a/f mm
109361	153.018-4	Rc 1/8	4	17.5	23.0	14
109362	153.018-6	Rc 1/8	6	19.0	24.4	14
109363	153.018-8	Rc 1/8	8	22.8	27.3	14
109364	153.018-10	Rc 1/8	10	27.2	27.3	17
109365	153.014-4	Rc 1/4	4	17.5	26.0	17
109366	153.014-6	Rc 1/4	6	19.0	27.4	17
109367	153.014-8	Rc 1/4	8	22.8	30.3	17
109368	153.014-10	Rc 1/4	10	27.2	34.3	17
109369	153.014-12	Rc 1/4	12	29.6	37.0	21
109370	153.038-6	Rc 3/8	6	19.0	28.7	21
109371	153.038-8	Rc 3/8	8	22.8	32.0	21
109372	153.038-10	Rc 3/8	10	27.2	36.3	21
109373	153.038-12	Rc 3/8	12	29.6	38.0	21
109374	153.038-16	Rc 3/8	16	32.5	40.5	24
109375	153.012-8	Rc 1/2	8	22.8	34.3	24
109376	153.012-10	Rc 1/2	10	27.2	38.8	24
109377	153.012-12	Rc 1/2	12	29.6	40.5	24
109378	153.012-16	Rc 1/2	16	32.5	43.0	24

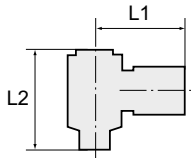

Banjo elbows with inner hex

»blue series«

EASY



170.014-6

Banjo elbow with inner hex, swivel type, parallel male thread with O-ring (NBR)

Art. No.	Type No.	Thread	For tube O.D. mm	L1 mm	L2 mm	Hexagon socket head mm	a/f mm
109391	170.018-4	G 1/8	4	22.5	28.5	4	14
109392	170.018-6	G 1/8	6	21.5	28.5	4	14
109393	170.018-8	G 1/8	8	24.5	28.5	4	14
109394	170.014-6	G 1/4	6	23.5	36.5	6	17
109395	170.014-8	G 1/4	8	26.5	36.5	6	17
109396	170.014-10	G 1/4	10	29.9	36.5	6	17
109397	170.014-12	G 1/4	12	30.8	36.5	6	17
109398	170.038-8	G 3/8	8	28.5	39.2	8	20
109399	170.038-10	G 3/8	10	31.9	39.2	8	20
109400	170.038-12	G 3/8	12	32.8	39.2	8	20
109401	170.012-12	G 1/2	12	35.4	42.7	8	24



163.014-6

Banjo elbow with inner hex, swivel type, conical male thread, coated

Art. No.	Type No.	Thread	For tube O.D. mm	L1 mm	L2 mm	Hexagon socket head mm	a/f mm
109379	163.018-4	R 1/8	4	22.5	29.0	4	14
109380	163.018-6	R 1/8	6	21.5	29.0	4	14
109381	163.018-8	R 1/8	8	24.5	29.0	4	14
109382	163.014-4	R 1/4	4	24.5	38.0	4	17
109383	163.014-6	R 1/4	6	23.5	38.0	6	17
109384	163.014-8	R 1/4	8	26.5	38.0	6	17

Banjo elbows with inner hex

»blue series«

EASY

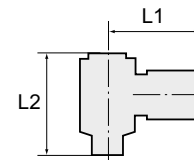

Banjo elbow with inner hex, swivel type, conical male thread, coated

Art. No.	Type No.	Thread	For tube O.D. mm	L1 mm	L2 mm	Hexagon socket head mm	a/f mm
109385	163.014-10	R 1/4	10	29.9	38.0	6	17
109386	163.014-12	R 1/4	12	30.8	38.0	6	17
109387	163.038-8	R 3/8	8	28.5	40.7	8	20
109388	163.038-10	R 3/8	10	31.9	40.7	8	20
109389	163.038-12	R 3/8	12	32.8	40.7	8	20
109390	163.012-10	R 1/2	10	34.7	45.2	8	24

Banjo elbows with outer hex

»blue series«

EASY

Banjo elbow with outer hex, swivel type, parallel male thread with O-ring (NBR)

Art. No.	Type No.	Thread	For tube O.D. mm	L1 mm	L2 mm	a/f mm
109402	145.005-4	M5	4	20.0	17.2	8
109403	145.005-6	M5	6	21.7	17.2	8
109404	145.018-4	G 1/8	4	22.3	23.5	10
109405	145.018-6	G 1/8	6	22.9	23.5	10
109406	145.018-8	G 1/8	8	25.3	23.5	10
109407	145.018-10	G 1/8	10	30.2	23.5	10
109408	145.014-4	G 1/4	4	24.0	26.0	14
109409	145.014-6	G 1/4	6	24.9	26.0	14
109410	145.014-8	G 1/4	8	28.4	26.0	14
109411	145.014-10	G 1/4	10	32.0	26.0	14
109412	145.014-12	G 1/4	12	32.0	26.0	14
109413	145.038-6	G 3/8	6	26.6	31.7	19
109414	145.038-8	G 3/8	8	29.3	31.7	19
109415	145.038-10	G 3/8	10	32.5	31.7	19
109416	145.038-12	G 3/8	12	35.3	31.7	19
109417	145.012-6	G 1/2	6	29.6	36.6	24
109418	145.012-8	G 1/2	8	32.3	36.6	24
109419	145.012-10	G 1/2	10	35.5	36.6	24
109420	145.012-12	G 1/2	12	36.3	36.6	24



145.014-8

Male branch tees

»blue series«

EASY

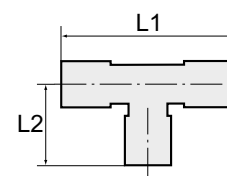

Male branch tee, swivel type, parallel male thread with O-ring (NBR)

Art. No.	Type No.	Thread	For tube O.D. mm	L1 mm	L2 mm	a/f mm
109471	131.005-4	M5	4	36.0	21.1	8
109472	131.005-6	M5	6	40.2	22.5	8
109473	131.018-4	G 1/8	4	36.0	20.0	10
109474	131.018-6	G 1/8	6	40.0	21.1	10
109475	131.018-8	G 1/8	8	45.4	25.7	14
109476	131.014-4	G 1/4	4	36.0	21.5	10
109477	131.014-6	G 1/4	6	40.0	22.6	10



131.014-12

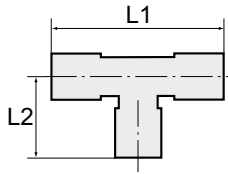

Male branch tees

»blue series«

EASY



131.014-12

Male branch tee, swivel type, parallel male thread with O-ring (NBR)

Art. No.	Type No.	Thread	For tube O.D. mm	L1 mm	L2 mm	a/f mm
109478	131.014-8	G 1/4	8	45.4	24.2	12
109479	131.014-10	G 1/4	10	53.8	27.6	17
109480	131.014-12	G 1/4	12	58.6	28.9	17
109481	131.038-6	G 3/8	6	40.0	21.0	20
109482	131.038-8	G 3/8	8	45.4	25.3	12
109483	131.038-10	G 3/8	10	53.8	26.1	20
109484	131.038-12	G 3/8	12	58.6	27.4	20
135646	131.038-14	G 3/8	14	63.6	35.2	20
109485	131.038-16	G 3/8	16	69.0	34.2	20
109486	131.012-6	G 1/2	6	40.0	26.1	12
109487	131.012-8	G 1/2	8	45.4	25.5	24
109488	131.012-10	G 1/2	10	53.8	29.0	17
109489	131.012-12	G 1/2	12	58.6	30.3	17
135647	131.012-14	G 1/2	14	63.6	33.4	24
109490	131.012-16	G 1/2	16	69.0	32.4	24



132.018-6

Male branch tee, swivel type, conical male thread, coated

Art. No.	Type No.	Thread	For tube O.D. mm	L1 mm	L2 mm	a/f mm
109491	132.018-4	R 1/8	4	36.0	24.0	10
109492	132.018-6	R 1/8	6	40.2	22.0	10
109493	132.018-8	R 1/8	8	45.4	30.6	10
109494	132.014-4	R 1/4	4	36.0	25.5	14
109495	132.014-6	R 1/4	6	40.2	27.0	14
109496	132.014-8	R 1/4	8	45.4	25.3	14
109497	132.014-10	R 1/4	10	53.8	35.6	17
109498	132.014-12	R 1/4	12	58.6	32.0	17
109499	132.038-6	R 3/8	6	40.2	28.6	17
109500	132.038-8	R 3/8	8	45.4	30.7	17
109501	132.038-10	R 3/8	10	53.8	24.1	17
109502	132.038-12	R 3/8	12	58.6	36.4	17
135648	132.038-14	R 3/8	14	63.6	37.2	20
109503	132.038-16	R 3/8	16	69.0	43.2	20
109504	132.012-6	R 1/2	6	40.2	31.6	21
109505	132.012-8	R 1/2	8	45.4	33.7	21
109506	132.012-10	R 1/2	10	53.8	37.1	21
109507	132.012-12	R 1/2	12	58.6	39.4	21
135649	132.012-14	R 1/2	14	63.6	40.2	21
109508	132.012-16	R 1/2	16	69.0	39.2	21

Male branch tees with female thread

»blue series«

EASY



148.018-8

Male branch tee with female thread, swivel type

Art. No.	Type No.	Thread	For tube O.D. mm	L1 mm	L2 mm	a/f mm
109509	148.005-4	M5	4	37.6	19.5	10
109510	148.005-6	M5	6	38.6	22.0	12
109511	148.018-4	G 1/8	4	37.6	24.0	14
109512	148.018-6	G 1/8	6	38.6	24.7	14

Male branch tees with female thread

»blue series«

EASY

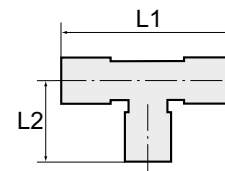

Male branch tee with female thread, swivel type						
Art. No.	Type No.	Thread	For tube O.D. mm	L1 mm	L2 mm	a/f mm
109513	148.018-8	G 1/8	8	44.9	27.3	14
109514	148.014-4	G 1/4	4	37.6	27.0	17
109515	148.014-6	G 1/4	6	38.6	28.0	17
109516	148.014-8	G 1/4	8	44.9	30.3	17
109517	148.014-10	G 1/4	10	57.0	35.0	17
109518	148.038-6	G 3/8	6	38.6	29.0	21
109519	148.038-8	G 3/8	8	44.9	32.0	21
109520	148.038-10	G 3/8	10	57.0	37.0	21
109521	148.012-10	G 1/2	10	57.0	39.5	24

Male branch tees, angled plug connections

»blue series«

EASY

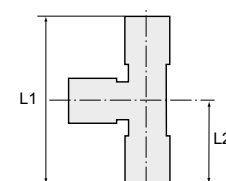

Male branch tee, angled plug connections, swivel type, parallel male thread with O-ring (NBR)						
Art. No.	Type No.	Thread	For tube O.D. mm	L1 mm	L2 mm	a/f mm
109522	129.005-4	M5	4	37.2	18.0	8
109523	129.005-6	M5	6	40.3	20.1	8
109524	129.018-4	G 1/8	4	36.1	18.0	10
109525	129.018-6	G 1/8	6	39.1	20.0	10
109526	129.018-8	G 1/8	8	45.2	22.7	14
109527	129.018-10	G 1/8	10	51.3	26.9	17
109528	129.018-12	G 1/8	12	54.9	29.3	17
109529	129.014-4	G 1/4	4	37.6	18.0	10
109530	129.014-6	G 1/4	6	40.6	20.0	10
109531	129.014-8	G 1/4	8	43.7	22.7	12
109532	129.014-10	G 1/4	10	52.3	26.9	17
109533	129.014-12	G 1/4	12	55.9	29.3	17
109534	129.038-6	G 3/8	6	41.7	20.0	12
109535	129.038-8	G 3/8	8	44.8	22.7	12
109536	129.038-10	G 3/8	10	50.8	26.9	20
109537	129.038-12	G 3/8	12	54.4	29.3	20
135650	129.038-14	G 3/8	14	31.8	64.0	20
109538	129.038-16	G 3/8	16	66.2	34.5	20
109539	129.012-6	G 1/2	6	44.1	20.0	12
109540	129.012-8	G 1/2	8	47.2	22.7	14
109541	129.012-10	G 1/2	10	53.7	26.9	17
109542	129.012-12	G 1/2	12	57.3	29.3	17
135651	129.012-14	G 1/2	14	31.8	62.2	24
109543	129.012-16	G 1/2	16	64.4	34.5	24



129.038-10



Male branch tee, angled plug connections, swivel type, conical male thread, coated						
Art. No.	Type No.	Thread	For tube O.D. mm	L1 mm	L2 mm	a/f mm
109544	130.018-4	R 1/8	4	37.1	18.0	10
109545	130.018-6	R 1/8	6	40.2	20.1	10
109546	130.018-8	R 1/8	8	46.1	22.7	10
109547	130.018-10	R 1/8	10	52.3	26.9	17
109548	130.014-4	R 1/4	4	38.6	18.0	14
109549	130.014-6	R 1/4	6	41.7	20.1	14



130.014-10

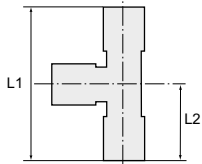

Male branch tees, angled plug connections

»blue series«

EASY



130.014-10

Male branch tee, angled plug connections, swivel type, conical male thread, coated

Art. No.	Type No.	Thread	For tube O.D. mm	L1 mm	L2 mm	a/f mm
109550	130.014-8	R 1/4	8	44.7	22.7	14
109551	130.014-10	R 1/4	10	54.3	26.9	17
109552	130.014-12	R 1/4	12	57.9	29.3	17
109553	130.038-6	R 3/8	6	43.2	20.1	17
109554	130.038-8	R 3/8	8	46.2	22.7	17
109555	130.038-10	R 3/8	10	52.8	26.9	17
109556	130.038-12	R 3/8	12	56.4	29.3	17
135652	130.038-14	R 3/8	14	31.8	66.0	20
109557	130.038-16	R 3/8	16	68.2	34.5	20
109558	130.012-6	R 1/2	6	46.2	20.1	21
109559	130.012-8	R 1/2	8	49.2	22.7	21
109560	130.012-10	R 1/2	10	55.8	26.9	21
109561	130.012-12	R 1/2	12	59.4	29.3	21
135653	130.012-14	R 1/2	14	31.8	69.0	21
109562	130.012-16	R 1/2	16	71.2	34.5	21

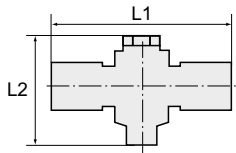

Male branch tees with inner hex

»blue series«

EASY



173.014-6

Male branch tee with inner hex, swivel type, parallel male thread with O-ring (NBR)

Art. No.	Type No.	Thread	For tube O.D. mm	L1 mm	L2 mm	Hexagon socket head mm	a/f mm
109563	173.018-4	G 1/8	4	45.0	28.5	4	14
109564	173.018-6	G 1/8	6	42.6	28.5	4	14
109565	173.018-8	G 1/8	8	48.5	28.5	4	14
109566	173.014-6	G 1/4	6	46.7	37.5	6	17
109567	173.014-8	G 1/4	8	52.5	37.5	6	17
109568	173.014-10	G 1/4	10	59.6	37.5	6	17
109569	173.014-12	G 1/4	12	60.7	37.5	6	17
109570	173.038-8	G 3/8	8	56.3	39.2	8	20
109571	173.038-10	G 3/8	10	63.5	39.2	8	20
109572	173.038-12	G 3/8	12	64.9	39.2	8	20



166.014-6

Male branch tee with inner hex, swivel type, conical male thread, coated

Art. No.	Type No.	Thread	For tube O.D. mm	L1 mm	L2 mm	Hexagon socket head mm	a/f mm
109573	166.018-4	R 1/8	4	45.0	29.0	4	14
109574	166.018-6	R 1/8	6	42.6	29.0	4	14
109575	166.018-8	R 1/8	8	48.5	29.0	4	14
109576	166.014-6	R 1/4	6	46.7	38.0	6	17
109577	166.014-8	R 1/4	8	52.5	38.0	6	17
109578	166.014-10	R 1/4	10	59.6	38.0	6	17
109579	166.014-12	R 1/4	12	61.2	38.0	6	17
109580	166.038-8	R 3/8	8	56.3	39.7	8	20
109581	166.038-10	R 3/8	10	63.5	39.7	8	20
109582	166.038-12	R 3/8	12	64.9	39.7	8	20

Male branch Y-fittings

»blue series«

EASY

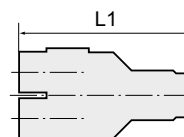

133.014-8

Male branch Y-fitting, swivel type, parallel male thread with O-ring (NBR)

Art. No.	Type No.	Thread	For tube O.D. mm	L1 mm	a/f mm
109583	133.005-4	M5	4	39.5	10
109584	133.005-6	M5	6	40.0	12
109585	133.018-4	G 1/8	4	42.5	12
109586	133.018-6	G 1/8	6	43.5	14
109587	133.018-8	G 1/8	8	46.3	14
109588	133.018-10	G 1/8	10	55.5	17
109589	133.018-12	G 1/8	12	58.4	21
109590	133.014-4	G 1/4	4	44.0	12
109591	133.014-6	G 1/4	6	45.0	14
109592	133.014-8	G 1/4	8	47.8	17
109593	133.014-10	G 1/4	10	56.5	17
109594	133.014-12	G 1/4	12	59.4	21
109595	133.038-6	G 3/8	6	46.5	14
109596	133.038-8	G 3/8	8	49.3	17
109597	133.038-10	G 3/8	10	58.0	20
109598	133.038-12	G 3/8	12	60.4	21
109599	133.038-16	G 3/8	16	69.0	24
109600	133.012-6	G 1/2	6	49.0	14
109601	133.012-8	G 1/2	8	52.8	17
109602	133.012-10	G 1/2	10	61.5	19
109603	133.012-12	G 1/2	12	63.9	24
109604	133.012-16	G 1/2	16	72.5	24

Male branch Y-fitting, swivel type, conical male thread, coated

Art. No.	Type No.	Thread	For tube O.D. mm	L1 mm	a/f mm
109605	134.018-4	R 1/8	4	42.0	10
109606	134.018-6	R 1/8	6	43.5	12
109607	134.018-8	R 1/8	8	46.8	14
109608	134.018-10	R 1/8	10	56.0	17
109609	134.018-12	R 1/8	12	59.8	21
109610	134.014-4	R 1/4	4	45.0	14
109611	134.014-6	R 1/4	6	46.0	14
109612	134.014-8	R 1/4	8	48.8	14
109613	134.014-10	R 1/4	10	58.0	17
109614	134.014-12	R 1/4	12	61.8	21
109615	134.038-6	R 3/8	6	47.5	17
109616	134.038-8	R 3/8	8	50.3	17
109617	134.038-10	R 3/8	10	59.0	17
109618	134.038-12	R 3/8	12	62.8	21
109619	134.038-16	R 3/8	16	72.0	24
109620	134.012-6	R 1/2	6	51.0	21
109621	134.012-8	R 1/2	8	53.8	21
109622	134.012-10	R 1/2	10	62.5	21
109623	134.012-12	R 1/2	12	65.8	21
109624	134.012-16	R 1/2	16	75.0	24



134.014-8



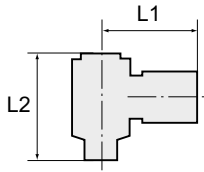

Male branch Y-elbows with outer hex

»blue series«

EASY



210.014-8



211.014-8

Male branch Y-elbow with outer hex, swivel type, parallel male thread with O-ring (NBR)

Art. No.	Type No.	Thread	For tube O.D. mm	L1 mm	L2 mm	a/f mm
109625	210.005-4	M5	4	24.0	22.0	12
109626	210.018-6	G 1/8	6	24.0	25.0	12
109627	210.014-8	G 1/4	8	28.5	31.5	14
135654	210.014-10	G 1/4	10	33.7	31.8	19
109628	210.038-10	G 3/8	10	33.7	35.9	19
135655	210.038-12	G 3/8	12	37.5	38.0	24
109629	210.012-12	G 1/2	12	37.5	43.0	24

Male branch Y-elbow with outer hex, swivel type, conical male thread, coated

Art. No.	Type No.	Thread	For tube O.D. mm	L1 mm	L2 mm	a/f mm
109630	211.018-6	R 1/8	6	24.0	25.0	12
125898	211.018-8	R 1/8	8	25.0	24.0	12
135656	211.014-6	R 1/4	6	24.0	27.0	14
109631	211.014-8	R 1/4	8	28.5	28.8	14
135657	211.014-10	R 1/4	10	33.7	33.8	19
109632	211.038-10	R 3/8	10	33.7	34.8	19
135658	211.038-12	R 3/8	12	37.5	39.6	24
109633	211.012-12	R 1/2	12	37.5	42.1	24

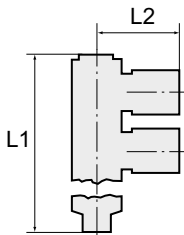

Multiple union elbows with inner hex

»blue series«

EASY



171.014-6



164.014-6

Multiple union elbow with inner hex, 2 outlets, swivel type, parallel male thread with O-ring (NBR)

Art. No.	Type No.	Thread	For tube O.D. mm	L1 mm	L2 mm	Hexagon socket head mm	a/f mm
109643	171.018-4	G 1/8	4	43.8	22.5	4	14
109644	171.018-6	G 1/8	6	43.8	21.5	4	14
109645	171.018-8	G 1/8	8	43.8	24.5	4	14
109646	171.014-4	G 1/4	4	58.0	24.7	6	17
109647	171.014-6	G 1/4	6	58.0	23.5	6	17
109648	171.014-8	G 1/4	8	58.0	26.5	6	17
109649	171.014-10	G 1/4	10	58.0	29.9	6	17
109650	171.014-12	G 1/4	12	58.0	30.8	6	17
109651	171.038-4	G 3/8	4	59.5	24.5	8	20
109652	171.038-6	G 3/8	6	59.5	23.6	8	20
109653	171.038-8	G 3/8	8	60.7	28.5	8	20
109654	171.038-10	G 3/8	10	60.7	31.9	8	20
109655	171.038-12	G 3/8	12	60.7	32.8	8	20
109656	171.012-8	G 1/2	8	64.2	28.5	8	24
109657	171.012-10	G 1/2	10	64.2	34.7	8	24
109658	171.012-12	G 1/2	12	64.2	35.4	8	24

Multiple union elbow with inner hex, 2 outlets, swivel type, conical male thread, coated

Art. No.	Type No.	Thread	For tube O.D. mm	L1 mm	L2 mm	Hexagon socket head mm	a/f mm
109659	164.018-4	R 1/8	4	44.3	22.5	4	14
109660	164.018-6	R 1/8	6	44.3	21.5	4	14
109661	164.018-8	R 1/8	8	44.3	24.5	4	14
109662	164.014-4	R 1/4	4	59.5	24.5	6	17
109663	164.014-6	R 1/4	6	59.5	23.5	6	17

Multiple union elbows with inner hex

»blue series«

EASY

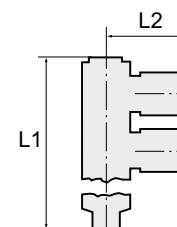

Multiple union elbow with inner hex, 2 outlets, swivel type, conical male thread, coated

Art. No.	Type No.	Thread	For tube O.D. mm	L1 mm	L2 mm	Hexagon socket head mm	a/f mm
109664	164.014-8	R 1/4	8	59.5	26.5	6	17
109665	164.014-10	R 1/4	10	59.5	29.9	6	17
109666	164.014-12	R 1/4	12	59.5	30.8	6	17
109667	164.038-4	R 3/8	4	61.0	24.5	8	17
109668	164.038-6	R 3/8	6	61.0	23.6	8	17
109669	164.038-8	R 3/8	8	62.2	28.5	8	20
109670	164.038-10	R 3/8	10	62.2	31.9	8	20
109671	164.038-12	R 3/8	12	66.2	32.8	8	20
109672	164.012-8	R 1/2	8	66.7	28.5	8	24
109673	164.012-10	R 1/2	10	66.7	34.7	8	24
109674	164.012-12	R 1/2	12	66.7	35.4	8	24

Multiple union elbow with inner hex, 3 outlets, swivel type, parallel male thread with O-ring (NBR)

Art. No.	Type No.	Thread	For tube O.D. mm	L1 mm	L2 mm	Hexagon socket head mm	a/f mm
109675	172.018-4	G 1/8	4	59.1	22.5	4	14
109676	172.018-6	G 1/8	6	59.1	21.5	4	14
109677	172.018-8	G 1/8	8	59.1	24.5	4	14
135690	172.014-4	G 1/4	4	79.5	24.5	6	17
109678	172.014-6	G 1/4	6	79.5	23.5	6	17
109679	172.014-8	G 1/4	8	79.5	26.5	6	17
109680	172.014-10	G 1/4	10	79.5	29.9	6	17
109681	172.014-12	G 1/4	12	79.5	30.8	6	17
135691	172.038-4	G 3/8	4	81.0	23.5	8	20
135692	172.038-6	G 3/8	6	81.0	24.5	8	20
109682	172.038-8	G 3/8	8	82.2	28.5	8	20
109683	172.038-10	G 3/8	10	82.2	31.9	8	20
109684	172.038-12	G 3/8	12	82.2	32.8	8	20
135693	172.012-8	G 1/2	8	85.7	28.5	8	24
135694	172.012-10	G 1/2	10	85.7	34.5	8	24
135695	172.012-12	G 1/2	12	85.7	35.4	8	24



172.014-6

Multiple union elbow with inner hex, 3 outlets, swivel type, conical male thread, coated

Art. No.	Type No.	Thread	For tube O.D. mm	L1 mm	L2 mm	Hexagon socket head mm	a/f mm
109685	165.018-4	R 1/8	4	59.6	22.5	4	14
109686	165.018-6	R 1/8	6	59.6	21.5	4	14
109687	165.018-8	R 1/8	8	59.6	24.5	4	14
135696	165.014-4	R 1/4	4	79.5	24.5	6	17
109688	165.014-6	R 1/4	6	81.0	23.5	6	17
109689	165.014-8	R 1/4	8	81.0	26.5	6	17
109690	165.014-10	R 1/4	10	81.0	29.9	6	17
109691	165.014-12	R 1/4	12	81.0	30.8	6	17
135697	165.038-4	R 3/8	4	81.0	23.5	6	20
135698	165.038-6	R 3/8	6	81.0	24.5	6	20
109692	165.038-8	R 3/8	8	83.7	28.5	8	20
109693	165.038-10	R 3/8	10	83.7	31.9	8	20
109694	165.038-12	R 3/8	12	83.7	32.8	8	20
135699	165.012-8	R 1/2	8	85.7	28.5	8	24
135700	165.012-10	R 1/2	10	85.7	34.5	8	24
135701	165.012-12	R 1/2	12	85.7	35.4	8	24



165.014-6



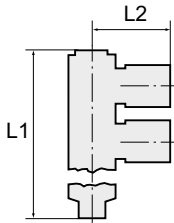

Multiple union elbows with outer hex

»blue series«

EASY



214.018-6

Multiple union elbow with outer hex, 4 outlets, swivel type, parallel male thread with O-ring (NBR)

Art. No.	Type No.	Thread	For tube O.D. mm	L1 mm	L2 mm	a/f mm
114594	214.018-4	G 1/8	4	39.0	24.0	14
109695	214.018-6	G 1/8	6	41.0	24.0	12
109696	214.018-8	G 1/8	8	44.0	28.5	14
109697	214.014-6	G 1/4	6	43.0	24.0	14
109698	214.014-8	G 1/4	8	46.0	28.5	17
109699	214.014-10	G 1/4	10	55.5	33.7	19
109700	214.038-10	G 3/8	10	56.5	33.7	19
109701	214.038-12	G 3/8	12	63.5	37.5	24
109702	214.012-12	G 1/2	12	65.0	37.5	24



215.018-6

Multiple union elbow with outer hex, 4 outlets, swivel type, conical male thread, coated

Art. No.	Type No.	Thread	For tube O.D. mm	L1 mm	L2 mm	a/f mm
109703	215.018-6	R 1/8	6	38.5	24.0	12
109704	215.018-8	R 1/8	8	41.6	28.5	14
109705	215.014-6	R 1/4	6	40.5	24.0	14
109706	215.014-8	R 1/4	8	43.6	28.5	14
109707	215.014-10	R 1/4	10	52.8	33.7	19
109708	215.038-10	R 3/8	10	53.8	33.7	19
109709	215.038-12	R 3/8	12	61.0	37.5	24
109710	215.012-12	R 1/2	12	64.0	37.5	24



225.014-8

Multiple union elbow with outer hex, 6 outlets, swivel type, parallel male thread with O-ring (NBR)

Art. No.	Type No.	Thread	For tube O.D. mm	L1 mm	L2 mm	a/f mm
114595	225.018-4	G 1/8	4	67.8	22.0	14
109711	225.018-6	G 1/8	6	52.3	24.0	14
109712	225.018-8	G 1/8	8	59.0	28.5	14
109713	225.014-6	G 1/4	6	54.5	24.0	17
109714	225.014-8	G 1/4	8	58.7	28.5	17
109715	225.014-10	G 1/4	10	71.3	33.7	19
109716	225.038-10	G 3/8	10	72.0	33.7	19
109717	225.038-12	G 3/8	12	80.6	37.5	24
109718	225.012-12	G 1/2	12	81.5	37.5	24



226.014-8

Multiple union elbow with outer hex, 6 outlets, swivel type, conical male thread, coated

Art. No.	Type No.	Thread	For tube O.D. mm	L1 mm	L2 mm	a/f mm
109719	226.018-6	R 1/8	6	52.0	24.0	12
109720	226.018-8	R 1/8	8	56.5	28.5	14
109721	226.014-6	R 1/4	6	54.0	24.0	14
109722	226.014-8	R 1/4	8	58.5	28.5	14
109723	226.014-10	R 1/4	10	71.5	33.7	19
109724	226.038-10	R 3/8	10	72.5	33.7	19
109725	226.038-12	R 3/8	12	72.5	37.5	24
109726	226.012-12	R 1/2	12	75.5	37.5	24

Unions

»blue series«

EASY

Union			
Art. No.	Type No.	For tube O.D. mm	L1 mm
109793	135.004	4	33.0
109794	135.006	6	34.6
109795	135.008	8	38.5
109796	135.010	10	47.0
109797	135.012	12	48.6
109798	135.014	14	48.7
152122	135.016-1	16	49.0



Reducer			
Art. No.	Type No.	For tube O.D. mm	L1 mm
109800	136.0604	6/4	31.0
109801	136.0804	8/4	36.5
109802	136.0806	8/6	34.5
109803	136.1006	10/6	40.2
109804	136.1008	10/8	39.4
109805	136.1208	12/8	45.0
109806	136.1210	12/10	44.2
109807	136.1612	16/12	49.6



Female bulkhead connectors

»blue series«

EASY

Female bulkhead connector					
Art. No.	Type No.	Thread for panel mounting	For tube O.D. mm	L1 mm	a/f mm
109808	149.004	M12x1.0	4	31.1	14
109809	149.006	M14x1.0	6	33.4	17
109810	149.008	M16x1.0	8	37.7	19
109811	149.010	M20x1.0	10	41.8	24
109812	149.012	M22x1.0	12	46.7	27
109813	149.016	M27x1.0	16	51.2	32

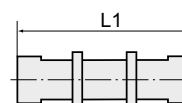

Female bulkhead connectors made of plastic

»blue series«

EASY

Female bulkhead connectors made of plastic					
Art. No.	Type No.	Thread for panel mounting	For tube O.D. mm	L1 mm	a/f mm
135757	149.004-K	M12x1.0	4	32.0	14
135758	149.006-K	M14x1.25	6	33.0	17
135759	149.008-K	M16x1.5	8	37.5	19
135760	149.010-K	M20x1.5	10	45.0	24
135761	149.012-K	M24x2.0	12	47.0	27



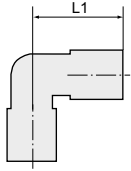

Union elbows

»blue series«

EASY



137.008

Union elbow			
Art. No.	Type No.	For tube O.D. mm	L1 mm
109814	137.004	4	17.5
109815	137.006	6	18.7
109816	137.008	8	22.4
109817	137.010	10	27.2
109818	137.012	12	28.9
109819	137.014	14	29.8
109820	137.016	16	30.8

Bulkhead connectors, elbow type

»blue series«

EASY

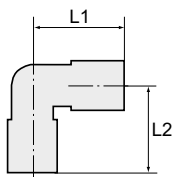

152.006

Bulkhead connector, elbow type						
Art. No.	Type No.	Thread for panel mounting	For tube O.D. mm	L1 mm	L2 mm	a/f mm
109821	152.004	M12x1.0	4	17.5	31.3	14
109822	152.006	M14x1.0	6	18.7	37.9	17
109823	152.008	M16x1.0	8	22.5	43.6	19
109824	152.010	M20x1.0	10	27.2	51.2	24
109825	152.012	M22x1.0	12	29.3	56.1	27
109826	152.016	M27x1.0	16	32.5	62.6	30

Union tees

»blue series«

EASY

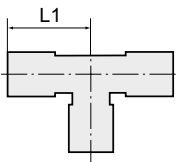

138.008

Union tee			
Art. No.	Type No.	For tube O.D. mm	L1 mm
109827	138.004	4	18.5
109828	138.006	6	19.0
109829	138.008	8	22.5
109830	138.010	10	27.9
109831	138.012	12	29.3
109832	138.014	14	31.0
109833	138.016	16	32.5

Union tee, unequal			
Art. No.	Type No.	For tube O.D. mm	L1 mm
109835	138.0604	2x6 / 1x4	19.0
109837	138.0804	2x8 / 1x4	22.0
109838	138.0806	2x8 / 1x6	22.5
109840	138.1006	2x10 / 1x6	27.1
109841	138.1008	2x10 / 1x8	27.9
109843	138.1208	2x12 / 1x8	28.5
109844	138.1210	2x12 / 1x10	29.3
109845	138.1612	2x16 / 1x12	31.8



138.0604

Union tees

»blue series«

EASY

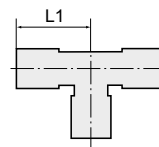

Union tee, two unequal connector on the side

Art. No.	Type No.	For tube O.D. mm	L1 mm
109834	138.0406	2x4 / 1x6	19.0
109836	138.0608	2x6 / 1x8	22.0
109839	138.0810	2x8 / 1x10	27.5
109842	138.1012	2x10 / 1x12	28.9
135762	138.1216	2x12 / 1x16	31.8



138.0406

Union tee, one unequal connector each on the side and in the centre

Art. No.	Type No.	For tube O.D. mm	L1 mm
109846	288.0406	4 / 4 / 6	19.0



288.0406

Y-unions

»blue series«

EASY

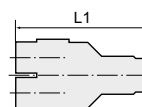

Y union

Art. No.	Type No.	For tube O.D. mm	L1 mm
109847	140.004	4	35.5
109848	140.006	6	36.5
109849	140.008	8	39.8
109850	140.010	10	48.9
109851	140.012	12	52.6
109852	140.014	14	54.6
109853	140.016	16	56.6



140.008

Y union, unequal

Art. No.	Type No.	For tube O.D. mm	L1 mm
109854	141.006	1x6 / 2x4	36.5
109855	141.0804	1x8 / 2x4	42.0
109856	141.008	1x8 / 2x6	39.8
109857	141.1006	1x10 / 2x6	43.8
109858	141.010	1x10 / 2x8	48.9
109859	141.1208	1x12 / 2x8	52.0
109860	141.012	1x12 / 2x10	52.6
135763	141.1612	1x16 / 2x12	56.3



141.008



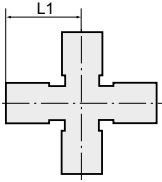

139.008

X-unions

»blue series«

EASY

X-union

Art. No.	Type No.	For tube O.D. mm	L1 mm
109861	139.004	4	17.5
109862	139.006	6	19.0
109863	139.008	8	22.8
109864	139.010	10	27.9
109865	139.012	12	29.3

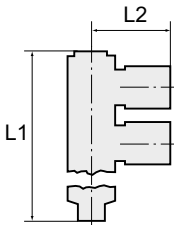

146.0806



162.006

Tee distributors with plug connection

»blue series«

EASY

Tee distributor with plug connection, 3 unequal outlets

Art. No.	Type No.	For tube O.D. mm	L1 mm	L2 mm
109866	146.0604	2x6 / 3x4	57.0	19.0
109867	146.0804	2x8 / 3x4	62.0	20.0
109868	146.0806	2x8 / 3x6	62.0	20.0
109869	146.1006	2x10 / 3x6	81.8	23.5
109870	146.1008	2x10 / 3x8	81.8	23.5

Tee distributor with plug connection

Art. No.	Type No.	For tube O.D. mm	L1 mm	L2 mm
109871	162.004	5x4	57.0	19.0
109872	162.006	5x6	61.0	20.3
109873	162.008	5x8	81.6	24.0

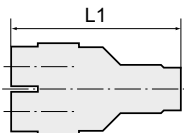

218.006-4

Distributors with plug connection

»blue series«

EASY

Distributor with plug connection, 4 outlets

Art. No.	Type No.	For tube O.D. mm	L1 mm
109874	218.006-4	6 / 4x4	36.0
109875	218.008-6	8 / 4x6	39.8

Reducers with push-in plug

»blue series«

EASY



Reducer with push-in plug					
Art. No.	Type No.	Plug connection mm	For tube O.D. mm	L1 mm	Material
109876	143.0406	6	4	39.5	Plastic/nickel-plated brass
109877	143.0408	8	4	41.5	Plastic/nickel-plated brass
109878	143.0608	8	6	41.5	Plastic/nickel-plated brass
109879	143.0610	10	6	46.5	Plastic/nickel-plated brass
109880	143.0612	12	6	40.5	Nickel-plated brass
109881	143.0810	10	8	46.8	Plastic/nickel-plated brass
109882	143.0812	12	8	46.8	Plastic/nickel-plated brass
109883	143.1012	12	10	52.2	Plastic/nickel-plated brass



143.0608



143.0612

Union elbows with push-in plug

»blue series«

EASY

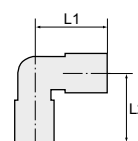

L-Steckverbinding mit Stecknippel					
Art. No.	Type No.	Plug connection mm	For tube O.D. mm	L1 mm	L2 mm
125725	157.0404-K	4	4	18.5	31.0
125727	157.0606-K	6	6	18.7	34.2
125729	157.0808-K	8	8	22.7	39.7
125731	157.1010-K	10	10	27.7	45.2
135768	157.1212-K	12	12	29.5	49.0
125733	157.1616-K	16	16	32.5	55.0



157.1010-K

Union elbow with push-in plug, unequal					
Art. No.	Type No.	Plug connection mm	For tube O.D. mm	L1 mm	L2 mm
125726	157.0604-K	6	4	18.5	33.0
125728	157.0806-K	8	6	18.7	36.7
135769	157.1006-K	10	6	18.7	38.2
125730	157.1008-K	10	8	22.7	41.2
135770	157.1208-K	12	8	22.7	43.2
125738	157.1210-K	12	10	27.7	47.2
135771	157.1612-K	16	12	29.5	52.0



157.1006-K

Y unions with push-in plug

»blue series«

EASY

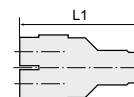

Y union with push-in plug				
Art. No.	Type No.	Plug connection mm	For tube O.D. mm	L1 mm
125719	142.004-K	4	4	47.5
125720	142.006-K	6	6	51.5
125721	142.008-K	8	8	55.5
125722	142.010-K	10	10	66.5
125723	142.012-K	12	12	72.0
135772	142.016-K	16	16	82.0



142.006-K



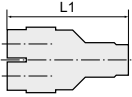

Y unions with push-in plug

»blue series«

EASY



158.0604-K

Y union with push-in plug, unequal

Art. No.	Type No.	Plug connection mm	For tube O.D. mm	L1 mm
125734	158.0604-K	6	4	49.5
125735	158.0806-K	8	6	54.0
135773	158.1006-K	10	6	57.0
125736	158.1008-K	10	8	57.0
135774	158.1208-K	12	8	68.5
125737	158.1210-K	12	10	68.5
135775	158.1610-K	16	12	82.0

Boxed set push-in fittings

»blue series«

EASY

Practical, high-quality assortment of the most popular parts in our »Blue Series« of push-in fittings, packaged in a sturdy plastic case.

Total of 31 different small part types, conveniently arranged in 24 plastic compartments. The inserts can be removed and rearranged inside the case according to individual needs. All inserts are labelled with the article numbers of the parts they contain.

Parts included:

- 40 male connectors G 1/8-4 • G 1/8-6 • G 1/4-6 • G 1/4-8 • G 3/8-8
- 30 swivel type male elbows G 1/8-4 • G 1/8-6 • G 1/4-6 • G 1/4-8 • G 3/8-8
- 25 unions 4, 6, 8 mm
- 15 reducers 6/4 • 8/6 • 10/8
- 10 male elbows 6, 8 mm
- 20 union tees 4, 6, 8 mm
- 9 reducers with push-in plug 6/8 • 6/10 • 8/10
- 10 plugs 6, 8 mm
- 10 sockets G 1/8 • G 1/4 • G 3/8
- 1 PTFE sealing tape
- 1 hose cutter



PIB 100

Boxed set push-in fittings

Art. No.	Type No.	Description
109907	PIB 100	Boxed set, »Blue Series« push-in fittings

- Boxed set quick disconnect couplings DN 7.2 see on page 496
- Boxed set, »click-clock« Series push-in fittings see at page 648
- Boxed sets, brass turned parts see at page 712
- Boxed sets, hose clamps see at page 884

Boxed set push-in fittings

»blue series« reduced assortment

EASY

Easy to handle plastic assortment box with reduced fitting, includes the most common articles of our push-in fittings »Blue Series«.

Parts included:

- 30 male connectors G 1/8-6 • G 1/4-6
- 27 male elbows G 1/8-6 • G 1/4-6 • G 1/4-8
- 20 unions 6, 8 mm
- 13 male elbows 8, 10 mm
- 18 Y unions 4, 6 mm
- 10 T unions 4 mm

Boxed set push-in fittings

Art. No.	Type No.	Description
131536	PIBR 100	Boxed set »Blue Series« with reduced assortment

- Boxed set quick disconnect couplings DN 7.2 see on page 496
- Boxed set, »click-clock« Series push-in fittings see at page 648
- Boxed sets, brass turned parts see at page 712
- Boxed sets, hose clamps see at page 884

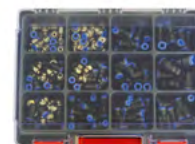

PIBR 100

Push-in plugs

»blue series«

EASY

Push-in plug

Art. No.	Type No.	Plug connection mm	L1 mm	Material
109914	178.004	4	36.0	Plastic
109915	178.006	6	38.0	Plastic
109916	178.008	8	38.0	Plastic
109917	178.010	10	40.2	Plastic
109918	178.012	12	44.0	Plastic
135803	178.016	16	56.0	Plastic

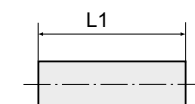

178.008

Push-in plug, unequal

Art. No.	Type No.	Plug connection mm	L1 mm	Material
109919	179.0604	6/4	37.5	Plastic
109920	179.0804	8/4	40.5	Plastic
109921	179.0806	8/6	42.5	Plastic
109922	179.1006	10/6	44.5	Plastic
109923	179.1008	10/8	47.0	Plastic
109924	179.1208	12/8	49.5	Plastic
109925	179.1210	12/10	51.0	Plastic
135804	179.1612	16/12	54.0	Nickel-plated brass



179.0604



179.1612



- Only recommended for use in combination with quick connectors of the »Blue Series«.
- Suitability testing for use with other series is the responsibility of the user.

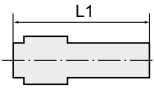

Plugs

»blue series«

EASY |



144.008

Plugs			
Art. No.	Type No.	Plug connection mm	L1 mm
109926	144.004	4	30.2
109927	144.006	6	33.6
109928	144.008	8	36.6
109929	144.010	10	40.1
109930	144.012	12	43.5
135835	144.016	16	49.0

→ Only recommended for use in combination with quick connectors of the »Blue Series«. Suitability testing for use with other series is the responsibility of the user.

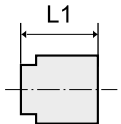

Caps

»blue series«

EASY |



184.016

Cap			
Art. No.	Type No.	For tube O.D. mm	L1 mm
109931	184.003	3	16.0
109932	184.004	4	16.0
109933	184.006	6	20.0
109934	184.008	8	21.0
109935	184.010	10	22.0
109936	184.012	12	23.0
109937	184.016	16	25.0

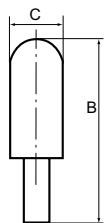

Silencers with push-in plug

»blue series«

EASY |



566.010

Silencers with push-in plug			
Art. No.	Type No.	Plug connection mm	L1 mm
109938	566.006	6	46.5
109939	566.008	8	45.0
109940	566.010	10	58.0
109941	566.012	12	81.5

→ Only recommended for use in combination with quick connectors of the »Blue Series«. Suitability testing for use with other series is the responsibility of the user.

Press-in sleeves

»blue series«

EASY

Press-in sleeve - can only be pressed into plastic

Art. No.	Type No.	For tube O.D. mm	L1 mm
109942	224.04	4	11.3
109943	224.06	6	11.9
109944	224.08	8	13.7
109945	224.10	10	15.2
109946	224.12	12	17.6

→ Only recommended for use in combination with quick connectors of the »Blue Series«. Suitability testing for use with other series is the responsibility of the user.

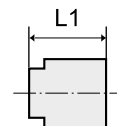

224.06

Unidirectional flow control valves with male thread and plug connection, straight type

»blue series«

EASY

Unidirectional flow control valve with parallel male thread and plug connection, straight type, air restriction from tube to port

Art. No.	Type No.	Thread	For tube O.D. mm	L1 mm	L2 mm	a/f mm
109947	183.018-4	G 1/8	4	46.5	28.9 - 31.2	12
109948	183.018-6	G 1/8	6	53.7	41.1 - 46.8	14
109949	183.018-8	G 1/8	8	58.1	41.7 - 47.4	14
109950	183.014-6	G 1/4	6	55.1	40.8 - 47.0	14
109951	183.014-8	G 1/4	8	59.6	44.8 - 50.8	17
109952	183.014-10	G 1/4	10	70.3	47.4 - 54.0	17
109953	183.014-12	G 1/4	12	80.6	50.3 - 55.3	21
109954	183.038-8	G 3/8	8	61.0	44.3 - 50.4	17
109955	183.038-10	G 3/8	10	71.6	48.5 - 55.3	20
109956	183.038-12	G 3/8	12	81.3	51.8 - 57.1	21
109957	183.012-10	G 1/2	10	76.0	48.3 - 54.5	19
109958	183.012-12	G 1/2	12	85.9	51.5 - 56.8	24

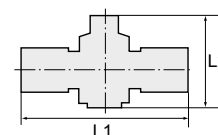
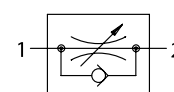

183.014-6

Unidirectional flow control valve with conical male thread and plug connection, straight type, air restriction from tube to port

Art. No.	Type No.	Thread	For tube O.D. mm	L1 mm	L2 mm	a/f mm
109959	182.018-4	R 1/8	4	45.9	26.9 - 29.0	10
109960	182.018-6	R 1/8	6	53.6	37.8 - 43.0	12
109961	182.018-8	R 1/8	8	58.4	41.5 - 47.2	14
109962	182.014-6	R 1/4	6	56.2	38.0 - 43.6	14
109963	182.014-8	R 1/4	8	60.6	41.1 - 47.1	14
109964	182.014-10	R 1/4	10	71.4	47.6 - 55.2	17
109965	182.014-12	R 1/4	12	82.3	51.8 - 55.6	21
109966	182.038-8	R 3/8	8	62.1	41.9 - 47.2	17
109967	182.038-10	R 3/8	10	71.8	48.3 - 54.9	17
109968	182.038-12	R 3/8	12	83.0	51.2 - 55.9	21
109969	182.012-10	R 1/2	10	75.4	48.0 - 54.6	21
109970	182.012-12	R 1/2	12	86.2	52.0 - 56.6	21



182.014-6



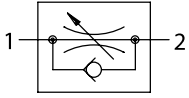

Unidirectional flow control valves with male thread and plug connection, straight type

»blue series«

EASY

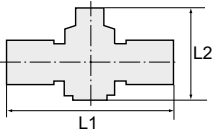

286.014-6

Unidirectional flow control valve with parallel male thread and plug connection, straight type, air restriction from port to tube

Art. No.	Type No.	Thread	For tube O.D. mm	L1 mm	L2 mm	a/f mm
135811	286.018-4	G 1/8	4	46.5	28.0 - 31.0	12
135812	286.018-6	G 1/8	6	54.1	40.7 - 47.5	14
135813	286.018-8	G 1/8	8	58.5	44.1 - 51.8	14
135814	286.014-6	G 1/4	6	55.6	40.7 - 47.5	14
135815	286.014-8	G 1/4	8	60.0	44.1 - 51.8	17
135816	286.014-10	G 1/4	10	69.9	47.7 - 55.3	17
135817	286.014-12	G 1/4	12	80.4	52.0 - 58.0	21
135818	286.038-8	G 3/8	8	61.5	44.1 - 51.8	17
135819	286.038-10	G 3/8	10	71.4	47.7 - 55.3	20
135820	286.038-12	G 3/8	12	81.4	52.0 - 58.0	21
135821	286.012-10	G 1/2	10	74.9	47.7 - 55.3	19
135822	286.012-12	G 1/2	12	84.9	52.0 - 58.0	24



287.014-6

Unidirectional flow control valve with conical male thread and plug connection, straight type, air restriction from port to tube

Art. No.	Type No.	Thread	For tube O.D. mm	L1 mm	L2 mm	a/f mm
135823	287.018-4	R 1/8	4	46.0	28.0 - 31.0	10
135824	287.018-6	R 1/8	6	54.1	40.7 - 47.5	12
135825	287.018-8	R 1/8	8	59.0	44.1 - 51.8	14
135826	287.014-6	R 1/4	6	56.6	40.7 - 47.5	14
135827	287.014-8	R 1/4	8	61.0	44.1 - 51.8	14
135828	287.014-10	R 1/4	10	71.4	47.7 - 55.3	17
135829	287.014-12	R 1/4	12	82.8	52.0 - 58.0	21
135830	287.038-8	R 3/8	8	62.5	44.1 - 51.8	17
135831	287.038-10	R 3/8	10	72.4	47.7 - 55.3	17
135832	287.038-12	R 3/8	12	83.8	52.0 - 58.0	21
135833	287.012-10	R 1/2	10	75.9	47.7 - 55.3	21
135834	287.012-12	R 1/2	12	86.8	52.0 - 58.0	21

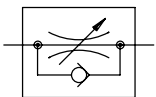

Unidirectional flow control valves with plug connection, straight type

»blue series«

EASY



181.0808

Unidirectional flow control valve with plug connection, straight type

Art. No.	Type No.	For tube O.D. mm	L1 mm	L2 mm
109972	181.0404	4	39.5	28.3 - 30.8
109973	181.0606	6	47.1	41.0 - 47.2
109974	181.0808	8	52.0	44.4 - 51.5
109975	181.1010	10	62.3	48.0 - 55.0
109976	181.1212	12	73.6	52.3 - 57.7

Unidirectional flow control valves with outgoing air restriction, angled

»blue series«

EASY

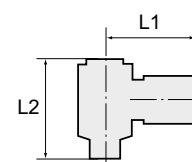
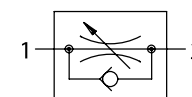

Unidirectional flow control valve with outgoing air restriction, adjustable with knurled screw, angled, swivel type, parallel male thread with O-ring (NBR)

Art. No.	Type No.	Thread	For tube O.D. mm	L1 mm	L2 mm	a/f mm
110011	188.005-4	M5	4	20.0	29.0 - 31.9	8
110012	188.005-6	M5	6	21.7	29.0 - 31.9	8
110013	188.018-4	G 1/8	4	22.3	37.8 - 44.0	10
110014	188.018-6	G 1/8	6	22.9	37.8 - 44.0	10
110015	188.018-8	G 1/8	8	25.3	37.8 - 44.0	10
110016	188.018-10	G 1/8	10	30.1	37.8 - 44.0	10
110017	188.014-4	G 1/4	4	24.0	44.0 - 51.0	14
110018	188.014-6	G 1/4	6	24.9	44.0 - 51.0	14
110019	188.014-8	G 1/4	8	28.4	44.0 - 51.0	14
110020	188.014-10	G 1/4	10	32.0	44.0 - 51.0	14
110021	188.014-12	G 1/4	12	32.0	44.0 - 51.0	14
110022	188.038-8	G 3/8	8	29.3	48.7 - 55.0	19
110023	188.038-10	G 3/8	10	32.5	48.7 - 55.0	19
110024	188.038-12	G 3/8	12	35.3	48.7 - 55.0	19
110025	188.012-8	G 1/2	8	32.3	53.0 - 59.2	24
110026	188.012-10	G 1/2	10	35.5	53.0 - 59.2	24
110027	188.012-12	G 1/2	12	36.3	53.0 - 59.2	24



188.018-6

Unidirectional flow control valve with outgoing air restriction, adjustable with slotted screw, angled, swivel type, parallel male thread with O-ring (NBR)

Art. No.	Type No.	Thread	For tube O.D. mm	L1 mm	L2 mm	a/f mm
110028	285.005-4	M5	4	20.0	23.0	8
110029	285.005-6	M5	6	21.5	23.0	8
110030	285.018-4	G 1/8	4	23.0	31.5	12
110031	285.018-6	G 1/8	6	23.0	31.5	12
110032	285.018-8	G 1/8	8	26.5	31.5	12
110033	285.014-4	G 1/4	4	25.0	38.3	14
110034	285.014-6	G 1/4	6	25.0	38.3	14
110035	285.014-8	G 1/4	8	29.0	38.3	14
110036	285.014-10	G 1/4	10	31.0	38.3	14
110037	285.038-6	G 3/8	6	27.0	43.0	19
110038	285.038-8	G 3/8	8	30.5	43.0	19
110039	285.038-10	G 3/8	10	32.0	43.0	19
110040	285.038-12	G 3/8	12	35.0	43.0	19
110041	285.012-8	G 1/2	8	33.0	49.0	24
110042	285.012-10	G 1/2	10	34.5	49.0	24
110043	285.012-12	G 1/2	12	36.5	49.0	24



285.014-8

Unidirectional flow control valve with outgoing air restriction, adjustable with knurled screw, angled, swivel type, conical male thread, coated

Art. No.	Type No.	Thread	For tube O.D. mm	L1 mm	L2 mm	a/f mm
110044	186.018-4	R 1/8	4	22.3	37.8 - 44.0	10
110045	186.018-6	R 1/8	6	22.9	37.8 - 44.0	10
110046	186.018-8	R 1/8	8	24.8	37.8 - 44.0	10
110047	186.018-10	R 1/8	10	30.1	37.8 - 44.0	10
110048	186.014-4	R 1/4	4	24.1	44.0 - 51.0	14
110049	186.014-6	R 1/4	6	24.9	44.0 - 51.0	14
110050	186.014-8	R 1/4	8	28.4	44.0 - 51.0	14
110051	186.014-10	R 1/4	10	32.0	44.0 - 51.0	14
110052	186.014-12	R 1/4	12	32.0	44.0 - 51.0	14
110053	186.038-6	R 3/8	6	26.6	48.7 - 55.0	19



186.014-10



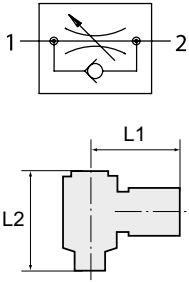

Unidirectional flow control valves with outgoing air restriction, angled

»blue series«

EASY

Unidirectional flow control valve with outgoing air restriction, adjustable with knurled screw, angled, swivel type, conical male thread, coated

Art. No.	Type No.	Thread	For tube O.D. mm	L1 mm	L2 mm	a/f mm
110054	186.038-8	R 3/8	8	29.2	48.7 - 55.0	19
110055	186.038-10	R 3/8	10	32.5	48.7 - 55.0	19
110056	186.038-12	R 3/8	12	35.3	48.7 - 55.0	19
110057	186.012-6	R 1/2	6	29.6	53.0 - 59.2	24
110058	186.012-8	R 1/2	8	32.3	53.0 - 59.2	24
110059	186.012-10	R 1/2	10	35.5	53.0 - 59.2	24
110060	186.012-12	R 1/2	12	36.3	53.0 - 59.2	24

Unidirectional flow control valves with outgoing air restriction, angled

»blue series«

EASY

Temperature range 0 to 60 °C

Unidirectional flow control valve with outgoing air restriction, adjustable with slotted screw, angled, swivel type, conical male thread, coated



297.014-8



297.012-8

Art. No.	Type No.	Thread	For tube O.D. mm	L1 mm	L2 mm	a/f mm
136005	297.018-4	R 1/8	4	21.3	33.5	12
136006	297.018-6	R 1/8	6	21.3	33.5	12
136007	297.018-8	R 1/8	8	25.3	33.5	12
136008	297.014-4	R 1/4	4	25.2	41.0	14
136009	297.014-6	R 1/4	6	25.2	41.0	14
136010	297.014-8	R 1/4	8	28.4	41.0	14
136011	297.014-10	R 1/4	10	32.6	41.0	14
136012	297.038-6	R 3/8	6	29.1	45.3	19
136013	297.038-8	R 3/8	8	29.3	45.3	19
136014	297.038-10	R 3/8	10	33.1	45.3	19
136015	297.038-12	R 3/8	12	35.5	43.5	19
136016	297.012-8	R 1/2	8	32.8	51.0	24
136017	297.012-10	R 1/2	10	36.0	51.0	24
136018	297.012-12	R 1/2	12	36.5	51.0	24

Unidirectional flow control valves with incoming air restriction, angled

»blue series«

EASY

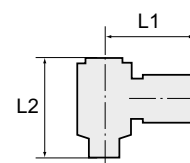
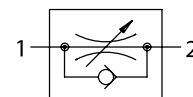

Unidirectional flow control valve with incoming air restriction, adjustable with knurled screw, angled, swivel type, parallel male thread with O-ring (NBR)

Art. No.	Type No.	Thread	For tube O.D. mm	L1 mm	L2 mm	a/f mm
109977	187.005-4	M5	4	20.0	29.0 - 31.9	8
109978	187.005-6	M5	6	21.7	29.0 - 31.9	8
109979	187.018-4	G 1/8	4	22.3	37.8 - 44.0	10
109980	187.018-6	G 1/8	6	22.9	37.8 - 44.0	10
109981	187.018-8	G 1/8	8	25.3	37.8 - 44.0	10
109983	187.014-4	G 1/4	4	24.0	44.0 - 51.0	14
109984	187.014-6	G 1/4	6	24.9	44.0 - 51.0	14
109985	187.014-8	G 1/4	8	28.4	44.0 - 51.0	14
109986	187.014-10	G 1/4	10	32.0	44.0 - 51.0	14
109987	187.014-12	G 1/4	12	32.0	44.0 - 51.0	14
109988	187.038-8	G 3/8	8	29.3	48.7 - 55.0	19
109989	187.038-10	G 3/8	10	32.5	48.7 - 55.0	19
109990	187.038-12	G 3/8	12	35.3	48.7 - 55.0	19
109991	187.012-8	G 1/2	8	32.3	53.0 - 59.2	24
109992	187.012-10	G 1/2	10	35.5	53.0 - 59.2	24
109993	187.012-12	G 1/2	12	36.3	53.0 - 59.2	24



Unidirectional flow control valve with incoming air restriction, adjustable with knurled screw, angled, swivel type, conical male thread, coated

Art. No.	Type No.	Thread	For tube O.D. mm	L1 mm	L2 mm	a/f mm
109994	185.018-4	R 1/8	4	22.3	37.8 - 44.0	10
109995	185.018-6	R 1/8	6	22.9	37.8 - 44.0	10
109996	185.018-8	R 1/8	8	25.3	37.8 - 44.0	10
109997	185.018-10	R 1/8	10	30.1	37.8 - 44.0	10
109998	185.014-4	R 1/4	4	24.1	44.0 - 51.0	14
109999	185.014-6	R 1/4	6	24.9	44.0 - 51.0	14
110000	185.014-8	R 1/4	8	28.4	44.0 - 51.0	14
110001	185.014-10	R 1/4	10	32.0	44.0 - 51.0	14
110002	185.014-12	R 1/4	12	32.0	44.0 - 51.0	14
110003	185.038-6	R 3/8	6	26.6	48.7 - 55.0	19
110004	185.038-8	R 3/8	8	29.2	48.7 - 55.0	19
110005	185.038-10	R 3/8	10	32.5	48.7 - 55.0	19
110006	185.038-12	R 3/8	12	35.3	48.7 - 55.0	19
110007	185.012-6	R 1/2	6	29.6	53.0 - 59.2	24
110008	185.012-8	R 1/2	8	32.3	53.0 - 59.2	24
110009	185.012-10	R 1/2	10	35.5	53.0 - 59.2	24
110010	185.012-12	R 1/2	12	36.3	53.0 - 59.2	24



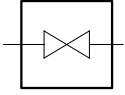

Shut-off valves with male thread

»blue series«

EASY

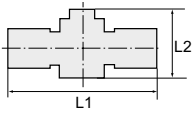

Shut-off valve, double parallel thread with O-ring (NBR)

Art. No.	Type No.	Thread 1	Thread 2	L1 mm	L2 mm	a/f mm
110061	194.1818	G 1/8	G 1/8	64.5	42.6	14/14
110062	194.1418	G 1/4	G 1/8	67.6	42.6	17/14
110063	194.1414	G 1/4	G 1/4	67.6	42.6	17/17
110064	194.3814	G 3/8	G 1/4	81.1	47.0	20/20
110065	194.3838	G 3/8	G 3/8	82.4	47.0	20/20
110066	194.1238	G 1/2	G 3/8	86.2	47.0	24/21
110067	194.1212	G 1/2	G 1/2	89.0	47.0	24/24

Shut-off valve, double conical thread, coated

Art. No.	Type No.	Thread 1	Thread 2	L1 mm	L2 mm	a/f mm
110068	191.1818	R 1/8	R 1/8	65.0	42.6	12/12
110069	191.1418	R 1/4	R 1/8	67.5	42.6	14/12
110070	191.1414	R 1/4	R 1/4	70.0	42.6	14/14
110071	191.3814	R 3/8	R 1/4	82.0	47.0	17/14
110072	191.3838	R 3/8	R 3/8	83.5	47.0	17/17
110073	191.1238	R 1/2	R 3/8	87.0	47.0	21/17
110074	191.1212	R 1/2	R 1/2	90.5	47.0	21/21

Shut-off valves with male thread and plug connection

»blue series«

EASY



Shut-off valve with male thread and plug connection, flow direction from port to tube, parallel male thread with O-ring (NBR)

Art. No.	Type No.	L1 mm	L2 mm	a/f mm
110075	193.018-6	58.0	42.6	14
110076	193.018-8	58.4	42.6	14
110077	193.014-6	59.8	42.6	14
110078	193.014-8	59.9	42.6	17
110079	193.014-10	70.9	47.0	17
110080	193.014-12	70.9	47.0	21
110081	193.038-8	61.4	42.6	17
110082	193.038-10	72.4	47.0	20
110083	193.038-12	71.9	47.0	21
110084	193.012-10	75.9	47.0	24
110085	193.012-12	75.4	47.0	24



Shut-off valve with male thread and plug connection, flow direction from port to tube, conical male thread, coated

Art. No.	Type No.	L1 mm	L2 mm	a/f mm
110086	192.018-6	58.0	42.6	12
110087	192.018-8	58.9	42.6	14
110088	192.014-6	60.5	42.6	12
110089	192.014-8	60.9	42.6	14
110090	192.014-10	72.4	47.0	17

Shut-off valves with male thread and plug connection

»blue series«

EASY

Shut-off valve with male thread and plug connection, flow direction from port to tube, conical male thread, coated

Art. No.	Type No.	L1 mm	L2 mm	a/f mm
110091	192.014-12	72.3	47.0	21
110092	192.038-8	62.4	42.6	17
110093	192.038-10	73.4	47.0	17
110094	192.038-12	74.3	47.0	21
110095	192.012-10	76.9	47.0	21
110096	192.012-12	77.3	47.0	21

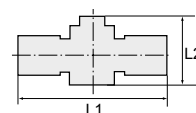
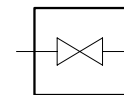

Shut-off valves with plug connection

»blue series«

EASY

Shut-off valve with plug connection

Art. No.	Type No.	L1 mm	L2 mm
110097	190.006	50.8	42.2
110098	190.008	51.8	42.3
110099	190.010	63.3	46.7
110100	190.012	64.1	46.8



190.006

3/2-way pilot valves with male thread

»blue series«

EASY

3/2-way pilot valve with parallel male thread with O-ring (NBR)

Art. No.	Type No.	Thread 1	Thread 2	L1 mm	L2 mm
110101	275.018	G 1/8	G 1/8	65.0	41.5
135946	275.1418	G 1/4	G 1/8	66.5	42.6
110102	275.014	G 1/4	G 1/4	68.0	41.5
135947	275.3814	G 3/8	G 1/4	80.0	47.0
110103	275.038	G 3/8	G 3/8	81.5	46.0
135948	275.1238	G 1/2	G 3/8	83.2	47.0
135949	275.012	G 1/2	G 1/2	86.7	47.0

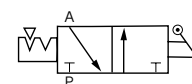

275.014



3/2-way pilot valve with conical male thread, coated

Art. No.	Type No.	Thread 1	Thread 2	L1 mm	L2 mm
110104	276.018	R 1/8	R 1/8	65.0	41.5
135953	276.1418	R 1/4	R 1/8	66.5	42.6
110105	276.014	R 1/4	R 1/4	70.0	41.5
135954	276.3814	R 3/8	R 1/4	82.5	47.0
110106	276.038	R 3/8	R 3/8	83.5	46.0
135955	276.1238	R 1/2	R 3/8	87.5	47.0



276.014

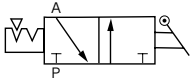

3/2-way pilot valves with male thread and plug connection

»blue series«

EASY

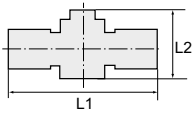

3/2-way pilot valve with male thread and plug connection, flow direction from port to tube, parallel male and female threads with O-ring (NBR)

Art. No.	Type No.	Thread	For tube O.D. mm	L1 mm	L2 mm	a/f mm
110108	231.018-6	G 1/8	6	58.1	41.5	14
110109	231.018-8	G 1/8	8	58.5	41.5	14
110110	231.014-6	G 1/4	6	59.6	41.5	14
110111	231.014-8	G 1/4	8	60.0	41.5	17
110112	231.014-10	G 1/4	10	70.9	46.0	17
110113	231.014-12	G 1/4	12	70.9	46.0	21
110114	231.038-6	G 3/8	6	61.1	41.5	14
110115	231.038-8	G 3/8	8	61.5	41.5	17
110116	231.038-10	G 3/8	10	72.4	46.0	20
110117	231.038-12	G 3/8	12	71.9	46.0	21
110118	231.012-10	G 1/2	10	74.9	46.0	24
110119	231.012-12	G 1/2	12	75.4	46.0	24



3/2-way pilot valve with male thread and plug connection, flow direction from port to tube, conical male thread, coated

Art. No.	Type No.	Thread	For tube O.D. mm	L1 mm	L2 mm	a/f mm
110120	232.018-6	R 1/8	6	58.3	41.5	12
110121	232.018-8	R 1/8	8	58.9	41.5	14
110122	232.014-6	R 1/4	6	60.8	41.5	14
110123	232.014-8	R 1/4	8	60.9	41.5	14
110124	232.014-10	R 1/4	10	72.6	46.0	17
110125	232.014-12	R 1/4	12	73.3	46.0	21
110126	232.038-6	R 3/8	6	62.3	41.5	17
110127	232.038-8	R 3/8	8	62.4	41.5	17
110128	232.038-10	R 3/8	10	73.6	46.0	17
110129	232.038-12	R 3/8	12	74.1	46.0	21
110130	232.012-10	R 1/2	10	77.1	46.0	21
110131	232.012-12	R 1/2	12	77.3	46.0	21



3/2-way pilot valve with male thread and plug connection, flow direction from tube to port, parallel male and female threads with O-ring (NBR)

Art. No.	Type No.	Thread	For tube O.D. mm	L1 mm	L2 mm	a/f mm
110132	273.018-6	G 1/8	6	58.1	41.5	14
110133	273.018-8	G 1/8	8	58.8	41.5	14
110134	273.014-6	G 1/4	6	59.6	41.5	14
110135	273.014-8	G 1/4	8	60.0	41.5	17
110136	273.014-10	G 1/4	10	70.9	46.0	17
110137	273.014-12	G 1/4	12	70.9	46.0	21
110138	273.038-6	G 3/8	6	61.1	41.5	14
110139	273.038-8	G 3/8	8	61.5	41.5	17
110140	273.038-10	G 3/8	10	72.4	46.0	20
110141	273.038-12	G 3/8	12	71.9	46.0	21
110142	273.012-10	G 1/2	10	74.9	46.0	24
110143	273.012-12	G 1/2	12	75.4	46.0	24



3/2-way pilot valve with male thread and plug connection, flow direction from tube to port, conical male thread, coated

Art. No.	Type No.	Thread	For tube O.D. mm	L1 mm	L2 mm	a/f mm
110144	274.018-6	R 1/8	6	58.3	41.5	12
110145	274.018-8	R 1/8	8	58.9	41.5	14
110146	274.014-6	R 1/4	6	60.8	41.5	14

3/2-way pilot valves with male thread and plug connection

»blue series«

EASY

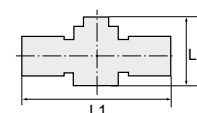
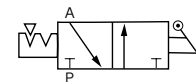

274.014-8

3/2-way pilot valve with male thread and plug connection, flow direction from tube to port, conical male thread, coated

Art. No.	Type No.	Thread	For tube O.D. mm	L1 mm	L2 mm	a/f mm
110147	274.014-8	R 1/4	8	60.9	41.5	14
110148	274.014-10	R 1/4	10	72.6	46.0	17
110149	274.014-12	R 1/4	12	73.3	46.0	21
110150	274.038-6	R 3/8	6	62.3	41.5	17
110151	274.038-8	R 3/8	8	62.4	41.5	17
110152	274.038-10	R 3/8	10	73.6	46.0	17
110153	274.038-12	R 3/8	12	74.1	46.0	21
110154	274.012-10	R 1/2	10	77.1	46.0	21
110155	274.012-12	R 1/2	12	77.3	46.0	21

3/2-way pilot valves with plug connection

»blue series«

EASY

3/2-way pilot valve with plug connection

Art. No.	Type No.	For tube O.D. mm	L1 mm	L2 mm
110156	233.006	6	51.6	41.5
110157	233.008	8	52.6	41.5
110158	233.010	10	63.7	46.0
110159	233.012	12	64.1	46.0



233.008



Stop valves

»blue series«

The air supply is completely shut off as soon as the hose is disconnected from the union.
The flow rate is only guaranteed if the hose is securely inserted.

Working pressure	0 - 10 bar
Temperature range	0 to 60 °C
Material	Plastic and nickel-plated brass
Medium	Compressed air
Recommended hose	PU or PA (nylon)

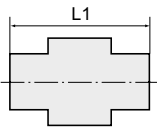

195.186-2



196.186-2

Straight stop valves

»blue series«

EASY

Sleeve Plastic blue

Straight stop valve, parallel male thread with O-ring (NBR)

Art. No.	Type No.	Thread	For tube O.D. mm	L1 mm	a/f mm	Standard thread
151439	195.184-2	G 1/8	4	24.5	12	DIN EN ISO 228-1
151440	195.186-2	G 1/8	6	27.5	14	DIN EN ISO 228-1
151441	195.188-2	G 1/8	8	31.5	14	DIN EN ISO 228-1
151442	195.146-2	G 1/4	6	27.5	14	DIN EN ISO 228-1
151443	195.148-2	G 1/4	8	33.5	14	DIN EN ISO 228-1
151444	195.1410-2	G 1/4	10	35.0	17	DIN EN ISO 228-1
151445	195.388-2	G 3/8	8	33.5	17	DIN EN ISO 228-1
151446	195.3810-2	G 3/8	10	35.0	20	DIN EN ISO 228-1
151447	195.3812-2	G 3/8	12	36.5	21	DIN EN ISO 228-1
151448	195.1210-2	G 1/2	10	35.0	19	DIN EN ISO 228-1
151449	195.1212-2	G 1/2	12	36.5	21	DIN EN ISO 228-1

Straight stop valve, conical male thread, coated

Art. No.	Type No.	Thread	For tube O.D. mm	L1 mm	a/f mm	Standard thread
151450	196.184-2	R 1/8	4	24.5	10	ISO 7-1
151451	196.186-2	R 1/8	6	27.5	12	ISO 7-1
151452	196.188-2	R 1/8	8	31.5	14	ISO 7-1
151453	196.146-2	R 1/4	6	27.5	14	ISO 7-1
151454	196.148-2	R 1/4	8	33.5	14	ISO 7-1
151455	196.1410-2	R 1/4	10	35.0	17	ISO 7-1
151456	196.388-2	R 3/8	8	33.5	17	ISO 7-1
151457	196.3810-2	R 3/8	10	35.0	17	ISO 7-1
151458	196.3812-2	R 3/8	12	36.5	21	ISO 7-1
151459	196.1210-2	R 1/2	10	35.0	21	ISO 7-1
151460	196.1212-2	R 1/2	12	36.5	21	ISO 7-1

Angle stop valves

»blue series«

EASY

Sleeve	Plastic blue
--------	--------------

Angle stop valve, swivel type, parallel male thread with O-ring (NBR)

Art. No.	Type No.	Thread	For tube O.D. mm	L1 mm	L2 mm	a/f mm	Standard thread
151461	197.54-2	M5	4	31.0	18.5	12	DIN 13-1
151462	197.56-2	M5	6	32.5	19.5	12	DIN 13-1
151463	197.184-2	G 1/8	4	31.0	21.0	14	DIN EN ISO 228-1
151464	197.186-2	G 1/8	6	32.5	22.0	14	DIN EN ISO 228-1
151465	197.188-2	G 1/8	8	39.5	24.5	14	DIN EN ISO 228-1
151466	197.146-2	G 1/4	6	32.5	23.0	17	DIN EN ISO 228-1
151467	197.148-2	G 1/4	8	39.5	25.5	17	DIN EN ISO 228-1
151468	197.1410-2	G 1/4	10	45.0	27.5	17	DIN EN ISO 228-1
151469	197.388-2	G 3/8	8	39.5	27.5	20	DIN EN ISO 228-1
151470	197.3810-2	G 3/8	10	45.0	29.5	20	DIN EN ISO 228-1
151471	197.3812-2	G 3/8	12	47.0	30.0	20	DIN EN ISO 228-1
151472	197.1210-2	G 1/2	10	45.0	32.0	24	DIN EN ISO 228-1
151473	197.1212-2	G 1/2	12	47.0	32.5	24	DIN EN ISO 228-1

Angle stop valve, swivel type, conical male thread, coated

Art. No.	Type No.	Thread	For tube O.D. mm	L1 mm	L2 mm	a/f mm	Standard thread
151474	198.184-2	R 1/8	4	31.0	21.0	12	ISO 7-1
151475	198.186-2	R 1/8	6	32.5	22.0	12	ISO 7-1
151476	198.188-2	R 1/8	8	39.5	25.0	14	ISO 7-1
151477	198.146-2	R 1/4	6	32.5	25.0	14	ISO 7-1
151478	198.148-2	R 1/4	8	39.5	27.5	14	ISO 7-1
151479	198.1410-2	R 1/4	10	45.0	30.0	17	ISO 7-1
151480	198.388-2	R 3/8	8	39.5	28.5	17	ISO 7-1
151481	198.3810-2	R 3/8	10	45.0	30.5	17	ISO 7-1
151482	198.3812-2	R 3/8	12	47.0	31.0	17	ISO 7-1
151483	198.1210-2	R 1/2	10	45.0	34.0	21	ISO 7-1
151484	198.1212-2	R 1/2	12	47.0	34.5	21	ISO 7-1

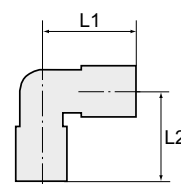

197.186-2



198.186-2

Stop unions

»blue series«

EASY

Sleeve	Plastic blue
--------	--------------

Stop union

Art. No.	Type No.	For tube O.D. mm	L1 mm
151485	199.04-2	4	46.0
151486	199.06-2	6	48.0
151487	199.08-2	8	56.0
151488	199.10-2	10	61.0
151489	199.12-2	12	66.0



199.06-2

6



Female bulkhead stop unions

»blue series«

EASY

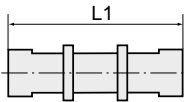

230.016-8

Female bulkhead stop union

Art. No.	Type No.	Thread	For tube O.D. mm	L1 mm	a/f mm
110211	230.012-4	M12x1.0	4	43.4	14
110212	230.014-6	M14x1	6	47.2	17
110213	230.016-8	M16x1.0	8	50.8	19
110214	230.020-10	M20x1.5	10	58.5	24
110215	230.024-12	M22x1.0	12	68.7	27

Non-return valves

»blue series«

The non-return function of these push-in fittings prevents the air from flowing back, the unidirectional design means air flow is only possible in one direction.

These valves are available with air flow from the port to the tube or from the tube to the port.

Working pressure	0 - 10 bar
Min. opening pressure	0.2 bar
Temperature range	0 to 60 °C
Material	Plastic and nickel-plated brass
Sleeve	Plastic blue
Medium	Compressed air
Recommended hose	PU or PA (nylon)

Straight non-return valves with male thread and plug connection, flow direction from port to tube

»blue series«

EASY |

Straight non-return valve, flow direction from port to tube, parallel male thread with O-ring (NBR)

Art. No.	Type No.	Thread	For tube O.D. mm	L1 mm	a/f mm	Standard thread
151490	200.54-2	M5	4	33.0	10	DIN 13-1
151491	200.184-2	G 1/8	4	28.0	14	DIN EN ISO 228-1
151492	200.186-2	G 1/8	6	30.0	14	DIN EN ISO 228-1
151493	200.188-2	G 1/8	8	33.0	14	DIN EN ISO 228-1
151494	200.146-2	G 1/4	6	29.5	17	DIN EN ISO 228-1
151495	200.148-2	G 1/4	8	35.5	17	DIN EN ISO 228-1
151496	200.3810-2	G 3/8	10	41.0	20	DIN EN ISO 228-1
151497	200.3812-2	G 3/8	12	44.5	20	DIN EN ISO 228-1
151498	200.1210-2	G 1/2	10	41.0	24	DIN EN ISO 228-1
151499	200.1212-2	G 1/2	12	44.5	24	DIN EN ISO 228-1

Straight non-return valve, flow direction from port to tube, conical male thread, coated

Art. No.	Type No.	Thread	For tube O.D. mm	L1 mm	a/f mm	Standard thread
151500	202.184-2	R 1/8	4	28.0	10	ISO 7-1
151501	202.186-2	R 1/8	6	30.0	12	ISO 7-1
151502	202.188-2	R 1/8	8	33.0	14	ISO 7-1
151503	202.146-2	R 1/4	6	30.0	14	ISO 7-1
151504	202.148-2	R 1/4	8	35.5	14	ISO 7-1
151505	202.3810-2	R 3/8	10	41.0	17	ISO 7-1
151506	202.3812-2	R 3/8	12	44.5	21	ISO 7-1
151507	202.1210-2	R 1/2	10	41.0	21	ISO 7-1
151508	202.1212-2	R 1/2	12	44.5	21	ISO 7-1

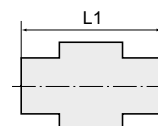
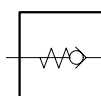

200-54-2



202.146-2



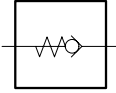

Straight non-return valves with male thread and plug connection, flow direction from tube to port

»blue series«

EASY

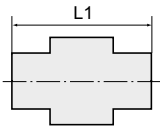

201.146-2



203-186-2

Straight non-return valve, flow direction from tube to port, parallel male thread with O-ring (NBR)

Art. No.	Type No.	Thread	For tube O.D. mm	L1 mm	a/f mm	Standard thread
151509	201.54-2	M5	4	33.0	10	DIN 13-1
151510	201.184-2	G 1/8	4	28.0	14	DIN EN ISO 228-1
151511	201.186-2	G 1/8	6	30.0	14	DIN EN ISO 228-1
151512	201.188-2	G 1/8	8	33.0	14	DIN EN ISO 228-1
151513	201.146-2	G 1/4	6	30.0	17	DIN EN ISO 228-1
151514	201.148-2	G 1/4	8	35.5	17	DIN EN ISO 228-1
151515	201.3810-2	G 3/8	10	41.0	20	DIN EN ISO 228-1
151516	201.3812-2	G 3/8	12	44.5	20	DIN EN ISO 228-1
151517	201.1210-2	G 1/2	10	41.0	24	DIN EN ISO 228-1
151518	201.1212-2	G 1/2	12	44.5	24	DIN EN ISO 228-1

Straight non-return valve, flow direction from tube to port, conical male thread, coated

Art. No.	Type No.	Thread	For tube O.D. mm	L1 mm	a/f mm	Standard thread
151519	203.184-2	R 1/8	4	28.0	10	ISO 7-1
151520	203.186-2	R 1/8	6	30.0	12	ISO 7-1
151521	203.188-2	R 1/8	8	33.0	14	ISO 7-1
151522	203.146-2	R 1/4	6	30.0	14	ISO 7-1
151523	203.148-2	R 1/4	8	35.5	14	ISO 7-1
151524	203.3810-2	R 3/8	10	41.0	17	ISO 7-1
151525	203.3812-2	R 3/8	12	44.5	21	ISO 7-1
151526	203.1210-2	R 1/2	10	41.0	21	ISO 7-1
151527	203.1212-2	R 1/2	12	44.5	21	ISO 7-1



Straight non-return valves with plug connection

»blue series«

EASY



204.12-2

Straight non-return valve with plug connection

Art. No.	Type No.	For tube O.D. mm	L1 mm	Material
151528	204.04-2	4	43.0	Nckel-plated brass
151529	204.06-2	6	46.0	Nckel-plated brass
151530	204.08-2	8	53.5	Nckel-plated brass
151531	204.10-2	10	61.5	Nckel-plated brass
151532	204.12-2	12	67.0	Nckel-plated brass

Push-in fittings

»click-clock« series

The advanced version of our highly successful push-in fittings series manufactured in nickel-plated brass.

Advantages of this new, optimised series:

- Much easier connection and disconnection of the hose, even with repeated mounting
- Can also be used for non-calibrated hoses
- Suitable for vacuum operation

Working pressure	-0.99 - 16 bar
Operating temperature	-20 to 80 °C
Material	Nickel-plated brass
Sleeve	Hostaform / nickel-plated brass (for hose O.D. 3 mm)
Clamping ring	Stainless steel
Recommended hose	PA, PU

Male connectors

»click-clock« series

PLUS

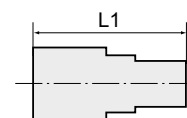

Male connector, parallel male thread with O-ring (NBR)

Art. No.	Type No.	Thread	For tube O.D. mm	L1 mm	Hexagon socket head mm	a/f mm	Outer hex
108547	745.003-3	M3	3	12.6	1.5	Ø 5.8	Without
108548	745.005-3	M5	3	13.0	2	Ø 5.8	Without
108549	745.005-4	M5	4	20.3	2.5	Ø 9	Without
108550	745.005-5	M5	5	22.5	2.5	Ø 12	Without
108551	745.005-6	M5	6	21.9	2.5	Ø 11	Without
108552	745.007-4	M7	4	18.9	3	Ø 9	Without
108553	745.007-6	M7	6	23.0	4	Ø 11	Without
108554	745.018-4	G 1/8	4	18.0	3	10	Out
108555	745.018-5	G 1/8	5	22.0	3	13	Out
108556	745.018-6	G 1/8	6	21.6	4	12	Out
108557	745.018-8	G 1/8	8	25.4	5	13	Out
108558	745.014-4	G 1/4	4	19.8	3	10	Out
108559	745.014-5	G 1/4	5	24.0	3	12	Out
108560	745.014-6	G 1/4	6	20.3	4	12	Out
108561	745.014-8	G 1/4	8	24.4	6	14	Out
108562	745.014-10	G 1/4	10	29.2	7	16	Out
108563	745.014-12	G 1/4	12	30.5	7	19	Out
108564	745.038-8	G 3/8	8	22.8	6	14	Out
108565	745.038-10	G 3/8	10	26.5	8	16	Out
108566	745.038-12	G 3/8	12	28.1	10	19	Out
108567	745.038-14	G 3/8	14	33.8	10	22	Out
108568	745.012-10	G 1/2	10	29.8	8	16	Out
108569	745.012-12	G 1/2	12	29.3	10	19	Out
108570	745.012-14	G 1/2	14	31.5	12	22	Out



745.014-8

Female connector, parallel female thread with outer hex

Art. No.	Type No.	Thread	For tube O.D. mm	L1 mm	a/f mm
108571	746.005-3	M5	3	15.7	7
108572	746.018-4	G 1/8	4	26.2	10
108573	746.018-5	G 1/8	5	27.5	12
108574	746.018-6	G 1/8	6	27.1	12
108575	746.018-8	G 1/8	8	28.1	13
108576	746.014-4	G 1/4	4	28.6	10
108577	746.014-5	G 1/4	5	29.5	12
108578	746.014-6	G 1/4	6	29.3	12
108579	746.014-8	G 1/4	8	30.0	14
108580	746.014-10	G 1/4	10	31.8	16



746.018-6



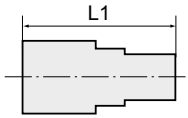

Male connectors

»click-clock« series

PLUS ||

Female connector, parallel female thread with outer hex

Art. No.	Type No.	Thread	For tube O.D. mm	L1 mm	a/f mm
108581	746.038-10	G 3/8	10	36.8	16
108582	746.038-12	G 3/8	12	37.0	19
108583	746.012-12	G 1/2	12	40.5	19



744.018-6

Male connector, conical male thread with outer hex

Art. No.	Type No.	Thread	For tube O.D. mm	L1 mm	Hexagon socket head mm	a/f mm
108584	744.018-4	R 1/8	4	18.5	3	10
108585	744.018-6	R 1/8	6	22.5	4	12
108586	744.018-8	R 1/8	8	26.0	5	13
108587	744.014-6	R 1/4	6	22.3	4	12
108588	744.014-8	R 1/4	8	25.5	6	14
108589	744.014-10	R 1/4	10	28.9	7	16
108590	744.038-8	R 3/8	8	24.9	6	14
108591	744.038-10	R 3/8	10	28.9	7	16
108592	744.038-12	R 3/8	12	27.0	10	19
108593	744.012-12	R 1/2	12	26.6	10	19

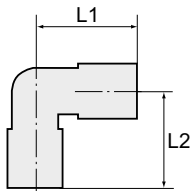

Male elbows

»click-clock« series

PLUS ||

Male elbow, swivel type, parallel male thread with O-ring (NBR)

Art. No.	Type No.	Thread	For tube O.D. mm	L1 mm	L2 mm	a/f mm
108594	754.005-4	M5	4	18.6	15.3	9
108595	754.005-5	M5	5	22.8	15.3	9
108596	754.005-6	M5	6	21.9	15.3	9
108597	754.018-4	G 1/8	4	18.6	19.1	12
108598	754.018-5	G 1/8	5	22.8	19.1	12
108599	754.018-6	G 1/8	6	21.9	19.1	12
108600	754.018-8	G 1/8	8	25.4	19.1	12
108601	754.014-4	G 1/4	4	18.6	21.1	14
108602	754.014-5	G 1/4	5	22.8	21.8	14
108603	754.014-6	G 1/4	6	21.9	21.1	14
108604	754.014-8	G 1/4	8	25.4	21.1	14
108605	754.014-10	G 1/4	10	27.2	24.8	14
108606	754.014-12	G 1/4	12	30.0	25.6	14
108607	754.038-8	G 3/8	8	23.6	27.1	17
108608	754.038-10	G 3/8	10	27.2	27.1	17
108609	754.038-12	G 3/8	12	30.0	27.1	17
108610	754.012-10	G 1/2	10	27.2	30.7	22
108611	754.012-12	G 1/2	12	30.0	30.7	22
108612	754.012-14	G 1/2	14	33.0	32.3	22



754.018-6

Male elbows

»click-clock« series

PLUS

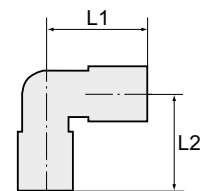

Male elbow, swivel type, conical male thread						
Art. No.	Type No.	Thread	For tube O.D. mm	L1 mm	L2 mm	a/f mm
108613	7754.018-4	R 1/8	4	18.6	19.8	12
108614	7754.018-6	R 1/8	6	21.9	19.8	12
108615	7754.018-8	R 1/8	8	25.4	19.8	12
108616	7754.014-4	R 1/4	4	18.6	22.6	14
108617	7754.014-6	R 1/4	6	21.9	22.6	14
108618	7754.014-8	R 1/4	8	25.4	23.6	14
108619	7754.014-10	R 1/4	10	27.2	26.3	14
108620	7754.038-8	R 3/8	8	23.6	27.1	17
108621	7754.038-10	R 3/8	10	27.2	27.1	17
108622	7754.038-12	R 3/8	12	30.0	27.1	17
108623	7754.012-12	R 1/2	12	30.0	31.9	22



7754.018-6

Male elbow, conical male thread						
Art. No.	Type No.	Thread	For tube O.D. mm	L1 mm	L2 mm	a/f mm
108624	752.018-4	R 1/8	4	18.6	16.0	10
108625	752.018-6	R 1/8	6	21.9	16.0	10
108626	752.018-8	R 1/8	8	25.4	16.0	10
108627	752.014-6	R 1/4	6	21.9	18.5	10
108628	752.014-8	R 1/4	8	25.4	18.5	10
108629	752.014-10	R 1/4	10	27.2	22.0	14



752.018-6

Banjo elbows with inner hex

»click-clock« series

PLUS

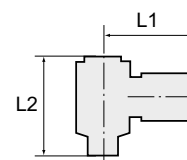

Banjo elbow with inner hex, swivel type, parallel male thread with O-ring (NBR)						
Art. No.	Type No.	Thread	For tube O.D. mm	L1 mm	L2 mm	a/f mm
108630	756.003-3	M3	3	12.2	13.2	1.5
108631	756.005-3	M5	3	12.7	13.7	2
108632	756.005-4	M5	4	20.2	18.4	2
108633	756.005-5	M5	5	24.0	19.0	2
108634	756.005-6	M5	6	23.5	18.4	2
108635	756.007-4	M7	4	20.2	18.5	3
108636	756.007-6	M7	6	23.5	18.5	3
108637	756.018-4	G 1/8	4	21.3	24.9	3
108638	756.018-5	G 1/8	5	24.8	26.2	3
108639	756.018-6	G 1/8	6	23.0	24.9	3
108640	756.018-8	G 1/8	8	24.8	24.9	3
108641	756.014-6	G 1/4	6	24.5	29.4	4
108642	756.014-8	G 1/4	8	26.5	29.4	4
108643	756.014-10	G 1/4	10	31.4	29.4	4
108644	756.014-12	G 1/4	12	33.0	29.4	4
108645	756.038-8	G 3/8	8	28.5	35.6	5
108646	756.038-10	G 3/8	10	32.8	35.6	5
108647	756.038-12	G 3/8	12	35.3	35.6	5
108648	756.012-12	G 1/2	12	37.0	40.8	8



756.018-6



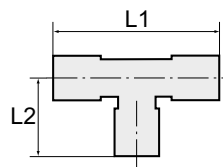

755.018-6

Male branch tees

»click-clock« series

PLUS

Male branch tee, swivel type, parallel male thread with O-ring (NBR)

Art. No.	Type No.	Thread	For tube O.D. mm	L1 mm	L2 mm	a/f mm
108649	755.005-4	M5	4	37.2	15.3	9
108650	755.005-6	M5	6	43.8	15.3	9
108651	755.018-4	G 1/8	4	37.2	19.1	12
108652	755.018-5	G 1/8	5	44.6	19.1	12
108653	755.018-6	G 1/8	6	43.8	19.1	12
108654	755.018-8	G 1/8	8	50.8	19.1	12
108655	755.014-4	G 1/4	4	37.2	21.1	14
108656	755.014-6	G 1/4	6	43.8	21.1	14
108657	755.014-8	G 1/4	8	50.8	21.1	14
108658	755.014-10	G 1/4	10	54.4	21.8	14
108659	755.038-8	G 3/8	8	47.2	27.1	17
108660	755.038-10	G 3/8	10	54.4	27.1	17
108661	755.038-12	G 3/8	12	59.0	27.1	17
108662	755.012-12	G 1/2	12	59.0	30.7	22
108663	755.012-14	G 1/2	14	66.0	32.3	22



7755.018-6

Male branch tee, swivel type, conical male thread

Art. No.	Type No.	Thread	For tube O.D. mm	L1 mm	L2 mm	a/f mm
108664	7755.018-4	R 1/8	4	37.2	19.8	12
108665	7755.018-6	R 1/8	6	43.8	19.8	12
108666	7755.018-8	R 1/8	8	50.8	19.8	12
108667	7755.014-4	R 1/4	4	37.2	22.6	14
108668	7755.014-6	R 1/4	6	43.8	22.6	14
108669	7755.014-8	R 1/4	8	50.8	23.6	14
108670	7755.014-10	R 1/4	10	54.4	26.3	14
108671	7755.038-8	R 3/8	8	47.2	27.1	17
108672	7755.038-10	R 3/8	10	54.4	27.1	17

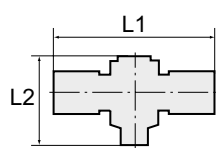

758.018-4 M

Male branch tees with inner hex

»click-clock« series

PLUS

Male branch tee with inner hex, swivel type, parallel male thread with O-ring (NBR)

Art. No.	Type No.	Thread	For tube O.D. mm	L1 mm	L2 mm	a/f mm
108673	758.005-4 M	M5	4	40.4	18.4	2
108674	758.005-5 M	M5	5	47.6	18.8	2
108675	758.005-6 M	M5	6	47.0	18.4	2
108676	758.007-4 M	M7	4	40.4	18.5	3
108677	758.007-6 M	M7	6	47.0	18.5	3
108678	758.018-4 M	G 1/8	4	42.6	24.9	3
108679	758.018-5 M	G 1/8	5	49.5	27.0	3
108680	758.018-6 M	G 1/8	6	46.0	24.9	3
108681	758.018-8 M	G 1/8	8	49.6	24.9	3
108682	758.014-6 M	G 1/4	6	49.0	29.4	4
108683	758.014-8 M	G 1/4	8	53.0	29.4	4

Male branch tees with inner hex

»click-clock« series

PLUS

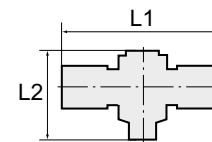

Male branch tee with inner hex, swivel type, parallel male thread with O-ring (NBR)

Art. No.	Type No.	Thread	For tube O.D. mm	L1 mm	L2 mm	a/f mm
108684	758.014-10 M	G 1/4	10	62.8	29.4	4
108685	758.014-12 M	G 1/4	12	66.0	29.4	4
108686	758.038-8 M	G 3/8	8	57.0	35.6	5
108687	758.038-10 M	G 3/8	10	65.6	35.6	5
108688	758.038-12 M	G 3/8	12	69.6	35.6	5
108689	758.012-12 M	G 1/2	12	73.0	40.8	8

Male branch tees, angled plug connections

»click-clock« series

PLUS

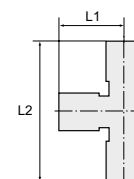

Male branch tee, angled plug connections, swivel type, parallel male thread with O-ring (NBR)

Art. No.	Type No.	Thread	For tube O.D. mm	L1 mm	L2 mm	a/f mm
108690	738.018-4	G 1/8	4	18.6	37.7	12
108691	738.018-6	G 1/8	6	21.9	41.0	12
108692	738.018-8	G 1/8	8	25.4	44.5	12
108693	738.014-6	G 1/4	6	21.9	43.0	14
108694	738.014-8	G 1/4	8	25.4	47.5	14
108695	738.014-10	G 1/4	10	27.2	49.0	14
108696	738.038-10	G 3/8	10	27.2	54.3	17
108697	738.038-12	G 3/8	12	30.0	57.1	17
108698	738.012-12	G 1/2	12	30.0	60.7	22



738.038-12

Push-in plug

»click-clock« series

PLUS

By combining these parts with unions, union elbows and union tees, you can obtain all essential connecting variants and simultaneously reduce your warehousing costs. Only recommended for use in combination with quick-connect fittings of the "click-clock" series. The suitability test for use with other series is the responsibility of the user.

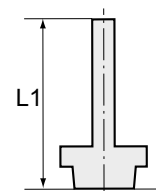

Push-in plug, parallel male thread with O-ring (NBR)

Art. No.	Type No.	Thread	For tube O.D. mm	L1 mm	a/f mm
108699	768.005-3	M5	3	16.8	5
108700	768.005-4	M5	4	25.2	8
108701	768.005-5	M5	5	25.2	8
108702	768.005-6	M5	6	25.7	9
108703	768.018-4	G 1/8	4	28.9	13
108704	768.018-5	G 1/8	5	28.9	13
108705	768.018-6	G 1/8	6	29.4	13
108706	768.018-8	G 1/8	8	30.6	13
108707	768.014-4	G 1/4	4	32.4	14
108708	768.014-5	G 1/4	5	32.4	14
108709	768.014-6	G 1/4	6	32.9	14
108710	768.014-8	G 1/4	8	34.0	14



768.014-6



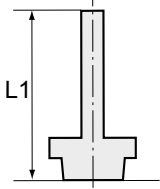

Push-in plug

»click-clock« series

PLUS



768.014-6

Push-in plug, parallel male thread with O-ring (NBR)

Art. No.	Type No.	Thread	For tube O.D. mm	L1 mm	a/f mm
108711	768.014-10	G 1/4	10	37.2	14
108712	768.014-12	G 1/4	12	40.7	14
108713	768.038-8	G 3/8	8	35.4	17
108714	768.038-10	G 3/8	10	37.1	17
108715	768.038-12	G 3/8	12	42.2	17
108716	768.038-14	G 3/8	14	46.2	17
108717	768.012-10	G 1/2	10	41.0	19
108718	768.012-12	G 1/2	12	44.2	22
108719	768.012-14	G 1/2	14	48.2	22

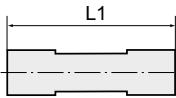

Unions

»click-clock« series

PLUS



747.008

Union

Art. No.	Type No.	Thread	For tube O.D. mm	L1 mm
108720	747.003-3	M8x0.75	3	18.4
108721	747.004	M11x1.0	4	30.6
108722	747.005	M14x1.0	5	33.5
108723	747.006	M13x1.0	6	33.0
108724	747.008	M15x1.0	8	35.7
108725	747.010	M17x1.0	10	39.2
108726	747.012	M20x1.0	12	39.7
108727	747.014	M24x1.0	14	45.9



747.0608

Reducer

Art. No.	Type No.	Thread	For tube O.D. mm	L1 mm
108728	747.0406	M13x1.0	4/6	32.7
108729	747.0408	M15x1.0	4/8	34.4
108730	747.0608	M15x1.0	6/8	35.0
108731	747.0610	M17x1.0	6/10	37.5
108732	747.0612	M20x1.0	6/12	39.0
108733	747.0810	M17x1.0	8/10	37.8
108734	747.0812	M20x1.0	8/12	40.1
108735	747.1012	M20x1.0	10/12	40.8

Female bulkhead connectors

»click-clock« series

PLUS

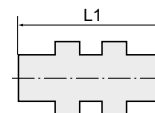

Female bulkhead connector					
Art. No.	Type No.	Thread	For tube O.D. mm	L1 mm	a/f mm
108736	751.008-3	M8x0.75	3	18.9	10
108737	751.012-4	M11x1.0	4	30.6	13
108738	751.014-5	M14x1.0	5	33.5	17
108739	751.014-6	M13x1.0	6	33.0	16
108740	751.016-8	M15x1.0	8	35.7	17
108741	751.020-10	M17x1.0	10	39.2	20
108742	751.022-12	M20x1.0	12	40.7	24
108743	751.024-14	M24x1.0	14	45.9	27



751.016-8

Female bulkhead connector, unequal					
Art. No.	Type No.	Thread	For tube O.D. mm	L1 mm	a/f mm
108744	751.013-46	M13x1.0	4/6	32.7	16
108745	751.015-48	M15x1.0	4/8	34.4	17
108746	751.015-68	M15x1.0	6/8	35.0	17
108747	751.017-610	M17x1.0	6/10	37.5	20
108748	751.017-810	M17x1.0	8/10	37.8	20
108749	751.020-612	M20x1.0	6/12	39.0	24
108750	751.020-812	M20x1.0	8/12	40.1	24
108751	751.020-1012	M20x1.0	10/12	40.8	24



751.015-68

Union elbows

»click-clock« series

PLUS

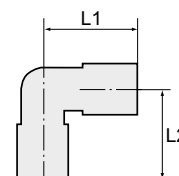

Union elbow				
Art. No.	Type No.	For tube O.D. mm	L1 mm	L2 mm
108752	748.003	3	10.4	10.4
108753	748.004	4	16.7	16.7
108754	748.005	5	19.2	19.2
108755	748.006	6	19.0	19.0
108756	748.008	8	21.3	21.3
108757	748.010	10	23.3	23.3
108758	748.012	12	26.0	26.0
108759	748.014	14	29.3	29.3



748.006



6

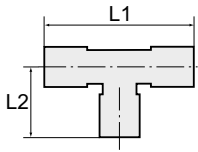

749.006

Union tees

»click-clock« series

PLUS

Union tee				
Art. No.	Type No.	For tube O.D. mm	L1 mm	L2 mm
108760	749.003	3	21.2	10.4
108761	749.004	4	33.4	16.7
108762	749.005	5	38.4	19.2
108763	749.006	6	38.0	19.0
108764	749.008	8	42.6	21.3
108765	749.010	10	46.6	23.3
108766	749.012	12	52.0	26.0
108767	749.014	14	58.6	29.3

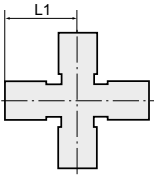

767.006

X-unions

»click-clock« series

PLUS

X-union			
Art. No.	Type No.	For tube O.D. mm	L1 mm
108768	767.004	4	18.6
108769	767.006	6	21.9
108770	767.008	8	25.4

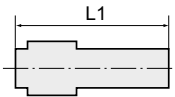

757.0604

Reducers with push-in plug

»click-clock« series

PLUS

Reducer with push-in plug				
Art. No.	Type No.	Plug connection mm	For tube O.D. mm	L1 mm
108771	757.0403	4	3	26.0
108772	757.0604	6	4	29.9
108773	757.0605	6	5	36.0
108774	757.0804	8	4	28.7
108775	757.0805	8	5	34.5
108776	757.0806	8	6	31.9
108777	757.1006	10	6	36.2
108778	757.1008	10	8	40.8
108779	757.1208	12	8	40.1
108780	757.1210	12	10	44.3
108781	757.1410	14	10	44.3
108782	757.1412	14	12	50.0

➔ Only recommended for use in combination with quick-connect fittings of the "click-clock" series. The suitability test for use with other series is the responsibility of the user.

Push-in plug

»click-clock« series

PLUS

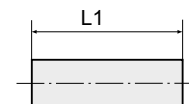

769.006

Push-in plug			
Art. No.	Type No.	For tube O.D. mm	L1 mm
108783	769.004	4	34.0
108784	769.005	5	34.0
108785	769.006	6	37.5
108786	769.008	8	37.5
108787	769.010	10	45.0
108788	769.012	12	48.0
108789	769.014	14	58.0

→ Only recommended for use in combination with quick-connect fittings of the "click-clock" series. The suitability test for use with other series is the responsibility of the user.

Plugs

»click-clock« series

PLUS

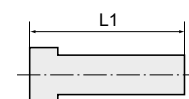

758.006

Plugs			
Art. No.	Type No.	Plug connection mm	L1 mm
108790	758.003	3	20.0
108791	758.004	4	27.0
108792	758.005	5	27.0
108793	758.006	6	29.8
108794	758.008	8	33.6
108795	758.010	10	36.8
108796	758.012	12	39.0
108797	758.014	14	39.5

→ Only recommended for use in combination with quick-connect fittings of the "click-clock" series. The suitability test for use with other series is the responsibility of the user.

Distributors with inner hex

»click-clock« series

PLUS

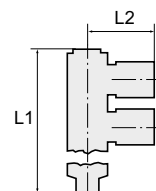

Multiple union elbow with inner hex, 2 outlets, swivel type, parallel male thread with O-ring (NBR)						
Art. No.	Type No.	Thread	For tube O.D. mm	L1 mm	L2 mm	a/f mm
108798	759.005-4 M	M5	4	30.3	20.2	2
108799	759.005-6 M	M5	6	30.3	23.5	2
108800	759.018-4 M	G 1/8	4	40.9	20.2	3
108801	759.018-5 M	G 1/8	5	42.0	25.0	5
108802	759.018-6 M	G 1/8	6	40.9	23.5	3
108803	759.018-8 M	G 1/8	8	40.9	24.8	3
108804	759.014-6 M	G 1/4	6	47.0	23.0	4
108805	759.014-8 M	G 1/4	8	47.0	26.5	4
108806	759.014-10 M	G 1/4	10	47.0	31.4	4



759.018-4 M

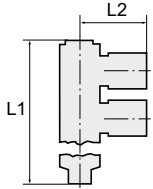

760.018-4 M

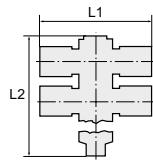

761.018-4 M

Distributors with inner hex

»click-clock« series

PLUS

Multiple union elbow with inner hex, 3 outlets, swivel type, parallel male thread with O-ring (NBR)

Art. No.	Type No.	Thread	For tube O.D. mm	L1 mm	L2 mm	a/f mm
108807	760.018-4 M	G 1/8	4	56.7	20.2	3
108808	760.018-6 M	G 1/8	6	56.7	23.5	3
108809	760.018-8 M	G 1/8	8	56.7	24.8	3
108810	760.014-6 M	G 1/4	6	64.3	25.6	4
108811	760.014-8 M	G 1/4	8	64.3	26.5	4
108812	760.014-10 M	G 1/4	10	64.3	31.4	4

Multiple union elbow with inner hex, 4 outlets, swivel type, parallel male thread with O-ring (NBR)

Art. No.	Type No.	Thread	For tube O.D. mm	L1 mm	L2 mm	a/f mm
108813	761.005-4 M	M5	4	40.4	29.9	2
108814	761.005-6 M	M5	6	47.0	29.9	2
108815	761.018-4 M	G 1/8	4	40.4	40.9	3
108816	761.018-6 M	G 1/8	6	46.0	41.1	3
108817	761.018-8 M	G 1/8	8	49.6	41.1	3
108818	761.014-6 M	G 1/4	6	49.0	47.0	4
108819	761.014-8 M	G 1/4	8	53.0	47.0	4
108820	761.014-10 M	G 1/4	10	62.8	47.0	4

Boxed set push-in fittings

»click-clock« series

PLUS

Practical, high-quality assortment of the most popular parts in our »click-clock« series of push-in fittings, manufactured in nickel-plated brass and packaged in a sturdy plastic case.

Total of 30 different small part types, conveniently arranged in 24 plastic compartments. The inserts can be removed and rearranged inside the case according to individual needs. All inserts are labeled with the article numbers of the parts they contain.

Parts included:

- 45 male connectors G 1/8-4 • G 1/8-6 • G 1/4-8 • G 3/8-8
- 35 swivel type male elbows G 1/8-4 • G 1/8-6 • G 1/4-6 • G 1/4-8 • G 3/8-8
- 15 unions 4, 6, 8 mm
- 10 union elbows 6, 8 mm
- 15 union tees 4, 6, 8 mm
- 15 swivel type male branch tees G 1/8-6 • G 1/4-6 • G 1/4-8
- 9 reducers with push-in plug 8/6 • 10/6 • 10/8
- 10 plugs 6, 8 mm
- 10 sockets G 1/8 • G 1/4 • G 3/8
- 1 PTFE sealing tape
- 1 hose cutter



PIB 200

Boxed set push-in fittings

Art. No.	Type No.	Description
108821	PIB 200	Boxed set, »click-clock« Series push-in fittings

- ➔ Boxed set quick disconnect couplings DN 7.2 see on page 496
- ➔ Boxed sets push-in fittings »Blue Series« see on page 622
- ➔ Boxed sets, brass turned parts see at page 712
- ➔ Boxed sets, hose clamps see at page 884

Banjo bolts

PLUS

Working pressure -0.98 - 16 bar
 Operating temperature -20 to 70 °C

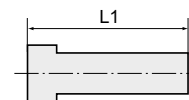

Banjo bolt, single

Art. No.	Type No.	Thread	L1 mm	a/f mm
108822	762.005	M5	17.5	8
108823	762.018	G 1/8	28.0	14
108824	762.014	G 1/4	33.0	17
108825	762.038	G 3/8	36.0	19



Banjo bolt, double

Art. No.	Type No.	Thread	L1 mm	a/f mm
108826	763.018	G 1/8	44.5	14
108827	763.014	G 1/4	51.5	17
108828	763.038	G 3/8	58.1	19



Banjo bolt, triple

Art. No.	Type No.	Thread	L1 mm	a/f mm
108829	764.018	G 1/8	60.0	14
108830	764.014	G 1/4	70.5	17
108831	764.038	G 3/8	80.0	19



Ring nipples

PLUS

Working pressure -0.98 - 16 bar
 Operating temperature -20 to 70 °C

L-ring nipple

Art. No.	Type No.	For banjo bolt	For tube O.D. mm	L1 mm	L2 mm	Sleeve
108832	765.005-4	M5	4	18.0	9.0	POM black
108833	765.018-4	G 1/8	4	20.5	15.0	POM black
108834	765.018-6	G 1/8	6	23.0	15.0	POM black
108835	765.018-8	G 1/8	8	24.5	15.0	POM black
108836	765.014-6	G 1/4	6	24.0	17.0	POM black
108837	765.014-8	G 1/4	8	26.0	17.0	POM black
108838	765.014-10	G 1/4	10	27.0	17.0	Black nickel-plated brass
108839	765.014-12	G 1/4	12	28.0	17.0	Black nickel-plated brass
108840	765.038-8	G 3/8	8	27.0	20.0	POM black
108841	765.038-10	G 3/8	10	28.0	20.0	Black nickel-plated brass
108842	765.038-12	G 3/8	12	29.0	20.0	Black nickel-plated brass

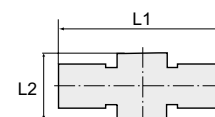
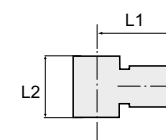

T-ring nipple

Art. No.	Type No.	For banjo bolt	For tube O.D. mm	L1 mm	L2 mm	Sleeve
108843	766.005-4	M5	4	36.0	9.0	POM black
108844	766.018-4	G 1/8	4	42.0	15.0	POM black
108845	766.018-6	G 1/8	6	46.0	15.0	POM black



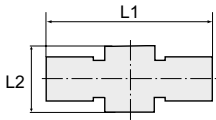

Ring nipples

PLUS ||



766.018-4

T-ring nipple

Art. No.	Type No.	For banjo bolt	For tube O.D. mm	L1 mm	L2 mm	Sleeve
108846	766.018-8	G 1/8	8	49.0	15.0	POM black
108847	766.014-6	G 1/4	6	48.0	17.0	POM black
108848	766.014-8	G 1/4	8	52.0	17.0	POM black
108849	766.014-10	G 1/4	10	52.0	17.0	Black nickel-plated brass
108850	766.038-8	G 3/8	8	54.0	20.0	POM black
108851	766.038-10	G 3/8	10	56.0	20.0	Black nickel-plated brass
108852	766.038-12	G 3/8	12	58.0	20.0	Black nickel-plated brass

→ Suitable sealing rings can be found at page 876-877

Push-in fittings

»metallica« series

Push-in fittings, manufactured entirely in nickel-plated brass. All parts with a parallel thread are supplied with an FPM O-ring while the conical threads are coated with preCOTE 5 dispersion; all fittings in this series can thus also be used at high temperatures (medium compressed air).

Working pressure	-0.98 - 16 bar
Operating temperature	-20 to 150 °C
Material	Nickel-plated brass
Sleeve	Nickel-plated brass
Clamping ring	Stainless steel
Recommended hose	PA and PU

Male connectors

»metallica« series

PLUS

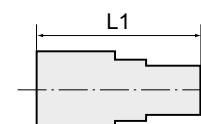

845.014-6

Male connector, parallel male thread with O-ring (FPM)						
Art. No.	Type No.	Thread	For tube O.D. mm	L1 mm	a/f mm	Outer hex
108854	845.005-4	M5	4	20.5	Ø 9	Without
108855	845.005-6	M5	6	22.5	Ø 10.5	Without
108856	845.018-4	G 1/8	4	20.0	9	With
108857	845.018-6	G 1/8	6	24.0	11	With
108858	845.018-8	G 1/8	8	26.5	13	With
108859	845.018-10	G 1/8	10	29.0	16	With
108860	845.014-4	G 1/4	4	21.0	9	With
108861	845.014-6	G 1/4	6	24.0	11	With
108862	845.014-8	G 1/4	8	25.0	13	With
108863	845.014-10	G 1/4	10	29.0	16	With
108864	845.014-12	G 1/4	12	30.0	18	With
108865	845.038-8	G 3/8	8	25.0	13	With
108866	845.038-10	G 3/8	10	29.5	16	With
108867	845.038-12	G 3/8	12	31.0	18	With
108868	845.038-14	G 3/8	14	34.0	21	With
136773	845.038-16	G 3/8	16	36.0	24	With
108869	845.012-10	G 1/2	10	31.0	16	With
108870	845.012-12	G 1/2	12	31.5	18	With
108871	845.012-14	G 1/2	14	34.5	21	With
136774	845.012-16	G 1/2	16	37.5	24	With

Female connector, parallel female thread with outer hex						
Art. No.	Type No.	Thread	For tube O.D. mm	L1 mm	a/f mm	
108872	846.018-4	G 1/8	4	26.5	9	
108873	846.018-6	G 1/8	6	27.0	11	
108874	846.018-8	G 1/8	8	28.0	13	
108875	846.014-4	G 1/4	4	29.5	9	
108876	846.014-6	G 1/4	6	31.0	11	
108877	846.014-8	G 1/4	8	32.0	13	
108878	846.014-10	G 1/4	10	32.0	16	
108879	846.014-12	G 1/4	12	40.0	20	
108880	846.038-10	G 3/8	10	37.5	20	
108881	846.038-12	G 3/8	12	39.5	20	
136775	846.012-16	G 1/2	16	41.0	24	



846.014-6



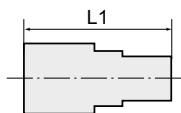

Male connectors

»metallica« series

PLUS



844.018-6

Male connector, conical male thread, coated with outer hex

Art. No.	Type No.	Thread	For tube O.D. mm	L1 mm	a/f mm
108882	844.018-4	R 1/8	4	22.5	10
108883	844.018-6	R 1/8	6	24.5	11
108884	844.018-8	R 1/8	8	27.5	13
108885	844.014-4	R 1/4	4	22.5	14
108886	844.014-6	R 1/4	6	24.5	14
108887	844.014-8	R 1/4	8	27.5	13
108888	844.014-10	R 1/4	10	32.5	16
108889	844.014-12	R 1/4	12	32.5	17
108890	844.038-8	R 3/8	8	28.0	17
108891	844.038-10	R 3/8	10	32.5	17
108892	844.038-12	R 3/8	12	30.5	17
108893	844.012-12	R 1/2	12	33.0	22

Male elbows

»metallica« series

PLUS

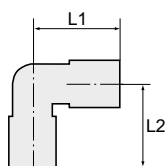

854.014-6

Male elbow, swivel type, parallel male thread with O-ring (FPM)

Art. No.	Type No.	Thread	For tube O.D. mm	L1 mm	L2 mm	a/f mm
108894	854.005-4	M5	4	18.0	14.5	9
108895	854.005-6	M5	6	21.0	14.5	9
108896	854.018-4	G 1/8	4	20.0	20.0	13
108897	854.018-6	G 1/8	6	21.0	20.0	13
108898	854.018-8	G 1/8	8	24.0	20.0	13
136776	854.018-10	G 1/8	10	26.5	23.5	13
108899	854.014-4	G 1/4	4	20.0	24.0	13
108900	854.014-6	G 1/4	6	21.0	24.0	13
108901	854.014-8	G 1/4	8	24.0	24.0	13
108902	854.014-10	G 1/4	10	27.0	24.0	16
108903	854.014-12	G 1/4	12	29.0	30.5	16
108904	854.038-8	G 3/8	8	24.0	25.5	13
108905	854.038-10	G 3/8	10	27.0	28.0	16
108906	854.038-12	G 3/8	12	29.0	28.5	20
137008	854.038-14	G 3/8	14	32.0	28.5	20
136777	854.038-16	G 3/8	16	33.5	33.0	20
108907	854.012-10	G 1/2	10	27.0	30.0	16
108908	854.012-12	G 1/2	12	29.0	35.0	20
137009	854.012-14	G 1/2	14	32.0	35.0	20
136778	854.012-16	G 1/2	16	33.5	38.0	20

Male elbow, swivel type, conical male thread, coated

Art. No.	Type No.	Thread	For tube O.D. mm	L1 mm	L2 mm	a/f mm
108909	8854.018-4	R 1/8	4	20.0	20.0	13
108910	8854.018-6	R 1/8	6	21.0	20.0	13
108911	8854.018-8	R 1/8	8	24.0	20.0	13
108912	8854.014-4	R 1/4	4	20.0	25.0	14
108913	8854.014-6	R 1/4	6	21.0	25.0	14
108914	8854.014-8	R 1/4	8	24.0	25.0	14
108915	8854.014-10	R 1/4	10	27.0	26.0	16

Male elbows

»metallica« series

PLUS

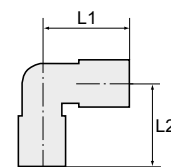

8854.014-6

Male elbow, swivel type, conical male thread, coated						
Art. No.	Type No.	Thread	For tube O.D. mm	L1 mm	L2 mm	a/f mm
108916	8854.038-8	R 3/8	8	24.0	28.0	18
108917	8854.038-10	R 3/8	10	27.0	30.0	18
108918	8854.038-12	R 3/8	12	29.0	32.5	20
137010	8854.038-14	R 3/8	14	32.0	32.5	20
108919	8854.012-12	R 1/2	12	29.0	35.5	22
137011	8854.012-14	R 1/2	14	32.0	35.5	22

Male branch tees

»metallica« series

PLUS

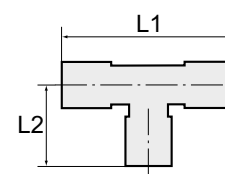

855.014-6

Male branch tee, swivel type, parallel male thread with O-ring (FPM)						
Art. No.	Type No.	Thread	For tube O.D. mm	L1 mm	L2 mm	a/f mm
108920	855.018-4	G 1/8	4	40.0	20.0	13
108921	855.018-6	G 1/8	6	43.0	20.0	13
108922	855.018-8	G 1/8	8	47.0	20.0	13
108923	855.014-6	G 1/4	6	43.0	24.0	13
108924	855.014-8	G 1/4	8	47.0	24.0	13
108925	855.014-10	G 1/4	10	53.0	24.0	16
108926	855.038-8	G 3/8	8	47.0	25.5	13
108927	855.038-10	G 3/8	10	53.0	28.0	16
108928	855.038-12	G 3/8	12	58.0	34.5	20
137012	855.038-14	G 3/8	14	64.0	28.5	20
108929	855.012-12	G 1/2	12	58.0	34.5	20
137013	855.012-14	G 1/2	14	64.0	33.5	20

Male branch tee, swivel type, conical male thread, coated						
Art. No.	Type No.	Thread	For tube O.D. mm	L1 mm	L2 mm	a/f mm
108930	8855.018-4	R 1/8	4	40.0	20.0	13
108931	8855.018-6	R 1/8	6	43.0	20.0	13
108932	8855.018-8	R 1/8	8	47.0	20.0	13
108933	8855.014-6	R 1/4	6	43.0	25.0	14
108934	8855.014-8	R 1/4	8	47.0	25.0	14
108935	8855.014-10	R 1/4	10	53.0	26.0	16
108936	8855.038-8	R 3/8	8	47.0	28.0	18
108937	8855.038-10	R 3/8	10	53.0	30.0	18
108938	8855.038-12	R 3/8	12	58.0	32.5	20
137014	8855.038-14	R 3/8	14	64.0	32.5	22
108939	8855.012-12	R 1/2	12	58.0	35.5	22
137015	8855.012-14	R 1/2	14	64.0	35.5	22



8855.014-6



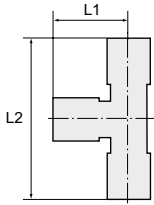

862.014-6

Male branch tees, angled plug connections

»metallica« series

PLUS

Male branch tee, angled plug connections, swivel type, parallel male thread with O-ring (FPM)

Art. No.	Type No.	Thread	For tube O.D. mm	L1 mm	L2 mm	a/f mm
108940	862.018-4	G 1/8	4	17.5	35.5	13
108941	862.018-6	G 1/8	6	21.0	41.5	13
108942	862.018-8	G 1/8	8	23.0	43.0	13
108943	862.014-6	G 1/4	6	21.0	45.5	13
108944	862.014-8	G 1/4	8	23.0	47.5	13
108945	862.014-10	G 1/4	10	27.0	51.0	16
108946	862.038-8	G 3/8	8	23.4	49.1	13
108947	862.038-10	G 3/8	10	27.0	54.0	16
108948	862.038-12	G 3/8	12	29.0	58.0	16
137016	862.038-14	G 3/8	14	32.0	60.5	20
108949	862.012-12	G 1/2	12	28.5	58.5	16
137017	862.012-14	G 1/2	14	33.0	67.0	20

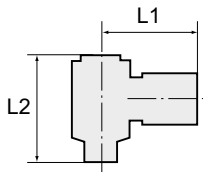

863.018-6

Banjo elbows with outer hex

»metallica« series

PLUS

Banjo elbow with outer hex, parallel male thread with O-ring (FPM)

Art. No.	Type No.	Thread	For tube O.D. mm	L1 mm	L2 mm	a/f mm
108950	863.005-4	M5	4	18.0	17.5	8
108951	863.005-5	M5	5	19.0	17.5	8
108952	863.005-6	M5	6	19.5	19.5	8
108953	863.018-4	G 1/8	4	20.5	28.0	14
108954	863.018-6	G 1/8	6	23.0	28.0	14
108955	863.018-8	G 1/8	8	24.5	28.0	14
108956	863.014-6	G 1/4	6	24.0	33.0	17
108957	863.014-8	G 1/4	8	26.0	33.0	17
108958	863.014-10	G 1/4	10	27.0	33.0	17
108959	863.038-8	G 3/8	8	27.0	36.0	19
108960	863.038-10	G 3/8	10	28.0	36.0	19
108961	863.038-12	G 3/8	12	29.0	36.0	19
108962	863.012-12	G 1/2	12	34.5	42.0	24

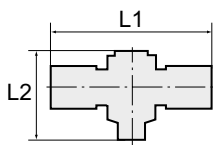

864.018-6

Male branch tees with outer hex

»metallica« series

PLUS

Male branch tee with outer hex, swivel type, parallel male thread with O-ring (FPM)

Art. No.	Type No.	Thread	For tube O.D. mm	L1 mm	L2 mm	a/f mm
108963	864.018-4	G 1/8	4	42.0	28.0	14
108964	864.018-6	G 1/8	6	46.0	28.0	14
108965	864.014-6	G 1/4	6	48.0	33.0	17

Unions

»metallica« series

PLUS

Union			
Art. No.	Type No.	For tube O.D. mm	L1 mm
108966	847.004	4	31.0
108967	847.006	6	33.0
108968	847.008	8	37.0
108969	847.010	10	39.0
108970	847.012	12	43.0
108971	847.014	14	48.0
136779	847.016	16	50.0



847.006

Reducer			
Art. No.	Type No.	For tube O.D. mm	L1 mm
108972	847.0604	6/4	33.0
108973	847.0806	8/6	39.0
108974	847.1008	10/8	39.0
108975	847.1210	12/10	42.5



847.1008

Female bulkhead connectors

»metallica« series

PLUS

Female bulkhead connector						
Art. No.	Type No.	Thread	For tube O.D. mm	L1 mm	a/f mm	
108976	851.010-4	M10x1.0	4	31.5	13	
108977	851.014-6	M14x1.0	6	33.5	17	
108978	851.016-8	M16x1.0	8	37.0	18	
108979	851.017-10	M17x1.0	10	39.5	20	
108980	851.020-12	M20x1.0	12	42.0	24	
108981	851.022-14	M22x1.0	14	46.0	25	
136780	851.028-16	M28x1.5	16	50.0	36	

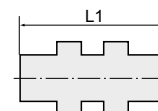

851.016-8

Union elbows

»metallica« series

PLUS

Union elbow					
Art. No.	Type No.	For tube O.D. mm	L1 mm	L2 mm	
108982	848.004	4	17.5	17.5	
108983	848.006	6	20.0	20.0	
108984	848.008	8	23.0	23.0	
108985	848.010	10	25.0	25.0	
108986	848.012	12	27.5	27.5	
108987	848.014	14	31.0	31.0	
136781	848.016	16	33.0	33.0	

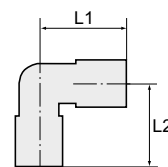

848.006



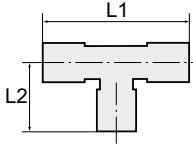

Union tees

»metallica« series

PLUS ||



849.006

Union tee				
Art. No.	Type No.	For tube O.D. mm	L1 mm	L2 mm
108988	849.004	4	34.0	17.0
108989	849.006	6	39.0	19.5
108990	849.008	8	46.0	23.0
108991	849.010	10	50.0	25.0
108992	849.012	12	54.0	27.0
108993	849.014	14	62.0	31.0
136782	849.016	16	72.0	36.0

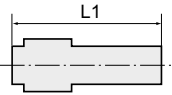

Reducers with push-in plug

»metallica« series

PLUS ||



867.0806

Reducer with push-in plug				
Art. No.	Type No.	Plug connection mm	For tube O.D. mm	L1 mm
108994	867.0604	6	4	29.5
108995	867.0806	8	6	32.5
108996	867.1008	10	8	38.5
108997	867.1210	12	10	41.0
137018	867.1412	14	12	44.0

→ Only recommended for use in combination with quick connectors of the »metallica« series. Suitability testing for use with other series is the responsibility of the user.

Removal tool

for push-in fittings



LW3-10

Removal tool for push-in fitting		
Art. No.	Type No.	For tube O.D. mm
108853	LW3-10	3 to 10
121863 NEW	LW4-14	4 to 14

Push-in fittings

»universal short« series

The quick-connect fittings of the »universal short« series are true to their name and are used for the quick and simple connection of hoses. The conical sealing threads offer a high degree of flexibility, as it is compatible with both conical and cylindrical threads. Thus the quick-connect fitting can be combined with a wide variety of thread types (BSPP, BSPT, NPT, NPTF, PT, PF) of standards ISO 7.1 and ISO 228. Shorter assembly ties result from the reduced thread length. The smaller hole spacing, resulting from the reduction of the width across flats, enables installation in very tight spaces. This saves time and space.

The complete sealing is also guaranteed on uneven, for example inclined, concave or convex surfaces, and with differing radii and chamfers. The special geometry of the seal enables vacuum applications.

Areas of application: Pneumatic automation, automotive industry, textile and packaging industry, compressed air circuits, vacuum applications.

Working pressure	-0.99 - 20 bar
Operating temperature	-20 to 80 °C
Material	Nickel-plated brass
Sealant	NBR
Sleeve	POM
Collet	Stainless steel
Recommended hose	PA, PU, PTFE

Male connectors

»universal short« series

MAX

Male connector, taper seat

Art. No.	Type No.	Thread	For tube O.D. mm	L1 mm	Hexagon socket head mm	a/f mm
153281	GS186MSVUNI	1/8	6	21.5	4	13
153282	GS188MSVUNI	1/8	8	24.5	5	14
153283	GS146MSVUNI	1/4	6	21.0	4	14
153284	GS148MSVUNI	1/4	8	22.0	6	14
153285	GS1410MSVUNI	1/4	10	28.0	7	17
153286	GS386MSVUNI	3/8	6	23.0	4	17
153287	GS388MSVUNI	3/8	8	23.0	6	17
153288	GS3810MSVUNI	3/8	10	25.5	8	17
153289	GS126MSVUNI	1/2	6	23.5	4	21
153290	GS128MSVUNI	1/2	8	23.5	6	21
153291	GS1210MSVUNI	1/2	10	26.0	8	21



GS3810MSVUNI

Male branch elbows

»universal short« series

MAX

Male branch elbow, swivel type, taper seat

Art. No.	Type No.	Thread	For tube O.D. mm	L1 mm	L2 mm	a/f mm
153292	WS186MSVUNI	1/8	6	21.0	21.5	13
153293	WS188MSVUNI	1/8	8	22.5	24.0	13
153294	WS146MSVUNI	1/4	6	21.0	23.0	15
153295	WS148MSVUNI	1/4	8	22.5	24.0	15
153296	WS1410MSVUNI	1/4	10	26.5	26.5	16
153297	WS388MSVUNI	3/8	8	22.5	24.5	17
153298	WS3810MSVUNI	3/8	10	26.5	24.5	17
153299	WS128MSVUNI	1/2	8	22.5	27.0	21
153300	WS1210MSVUNI	1/2	10	26.5	27.0	21

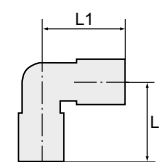

WS146MSVUNI

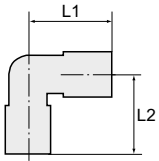

Male branch elbows

»universal short« series

MAX



WSL146MSVUNI

Male branch elbow, long type, swivel type, taper seat

Art. No.	Type No.	Thread	For tube O.D. mm	L1 mm	L2 mm	a/f mm
153301	WSL186MSVUNI	1/8	6	21.0	36.0	12
153302	WSL188MSVUNI	1/8	8	22.5	40.5	12
153303	WSL146MSVUNI	1/4	6	21.0	37.5	15
153304	WSL148MSVUNI	1/4	8	22.5	40.5	15
153305	WSL1410MSVUNI	1/4	10	26.5	46.0	15
153306	WSL388MSVUNI	3/8	8	22.5	41.0	16
153307	WSL3810MSVUNI	3/8	10	26.5	44.0	17

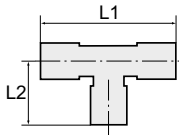

Male branch tees

»universal short« series

MAX



TS146MSVUNI

Male branch tee, swivel type, taper seat

Art. No.	Type No.	Thread	For tube O.D. mm	L1 mm	L2 mm	a/f mm
153308	TS186MSVUNI	1/8	6	42.0	22.0	13
153309	TS188MSVUNI	1/8	8	45.0	25.5	13
153310	TS146MSVUNI	1/4	6	42.0	23.5	15
153311	TS148MSVUNI	1/4	8	45.0	25.5	15
153312	TS1410MSVUNI	1/4	10	53.0	29.0	16
153313	TS388MSVUNI	3/8	8	45.0	26.0	17
153314	TS3810MSVUNI	3/8	10	53.0	27.0	17
153315	TS128MSVUNI	1/2	8	45.0	28.5	21
153316	TS1210MSVUNI	1/2	10	53.0	29.5	21



TSL146MSVUNI

Male branch tee, angled plug connection, swivel type, taper seat

Art. No.	Type No.	Thread	For tube O.D. mm	L1 mm	L2 mm	a/f mm
153317	TSL186MSVUNI	1/8	6	43.0	21.0	13
153318	TSL188MSVUNI	1/8	8	47.5	22.5	13
153319	TSL146MSVUNI	1/4	6	44.5	21.0	15
153320	TSL148MSVUNI	1/4	8	47.5	22.5	15
153321	TSL1410MSVUNI	1/4	10	52.5	26.5	16
153322	TSL388MSVUNI	3/8	8	50.5	22.5	17
153323	TSL3810MSVUNI	3/8	10	52.5	26.5	17
153324	TSL128MSVUNI	1/2	8	50.5	22.5	21
153325	TSL1210MSVUNI	1/2	10	55.0	26.5	21

Push-in fittings

stainless steel

For use in more aggressive environments and corrosive media.
The suitability test for the individual application is the user's responsibility.

Material	Stainless steel 1.4404
Sealant	FPM
Max. working pressure	20 bar
Medium temperature	-20 to 150 °C
Operating temperature	-20 to 150 °C
Suitable pipe materials	PVDF, PTFE, PA, PU

Male connectors

stainless steel

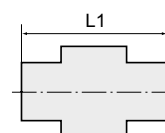

844.014-10 ES

Male connector, parallel male thread with O-ring (FPM) and outer hex

Art. No.	Type No.	Thread	For tube O.D. mm	L1 mm	a/f mm	Standard thread
135058	844.005-4 ES	M5	4	23.8	11	DIN 13-1
135059	844.018-4 ES	G 1/8	4	22.8	14	DIN EN ISO 228-1
135060	844.018-6 ES	G 1/8	6	24.3	14	DIN EN ISO 228-1
135061	844.018-8 ES	G 1/8	8	26.0	14	DIN EN ISO 228-1
135062	844.014-4 ES	G 1/4	4	23.8	17	DIN EN ISO 228-1
135063	844.014-6 ES	G 1/4	6	24.0	17	DIN EN ISO 228-1
135064	844.014-8 ES	G 1/4	8	24.5	17	DIN EN ISO 228-1
135065	844.014-10 ES	G 1/4	10	27.4	17	DIN EN ISO 228-1
135066	844.014-12 ES	G 1/4	12	28.4	19	DIN EN ISO 228-1
135067	844.038-8 ES	G 3/8	8	23.8	21	DIN EN ISO 228-1
135068	844.038-10 ES	G 3/8	10	24.3	21	DIN EN ISO 228-1
135069	844.038-12 ES	G 3/8	12	28.8	21	DIN EN ISO 228-1
135070	844.038-14 ES	G 3/8	14	29.8	22	DIN EN ISO 228-1
135071	844.012-10 ES	G 1/2	10	26.0	27	DIN EN ISO 228-1
135072	844.012-12 ES	G 1/2	12	28.4	27	DIN EN ISO 228-1
135073	844.012-14 ES	G 1/2	14	30.0	27	DIN EN ISO 228-1
135074	844.012-16 ES	G 1/2	16	32.2	27	DIN EN ISO 228-1

Male connector, conical male thread with outer hex

Art. No.	Type No.	Thread	For tube O.D. mm	L1 mm	a/f mm	Standard thread
135075	845.018-4 ES	R 1/8	4	22.6	11	ISO 7-1
135076	845.018-6 ES	R 1/8	6	25.0	13	ISO 7-1
135077	845.018-8 ES	R 1/8	8	26.3	14	ISO 7-1
135078	845.014-4 ES	R 1/4	4	23.3	14	ISO 7-1
135079	845.014-6 ES	R 1/4	6	25.5	14	ISO 7-1
135080	845.014-8 ES	R 1/4	8	26.3	14	ISO 7-1
135081	845.014-10 ES	R 1/4	10	29.3	17	ISO 7-1
135082	845.014-12 ES	R 1/4	12	31.0	19	ISO 7-1
135083	845.038-8 ES	R 3/8	8	24.3	17	ISO 7-1
135084	845.038-10 ES	R 3/8	10	26.8	17	ISO 7-1
135085	845.038-12 ES	R 3/8	12	28.2	21	ISO 7-1
135086	845.038-14 ES	R 3/8	14	32.7	22	ISO 7-1
135087	845.012-10 ES	R 1/2	10	27.8	22	ISO 7-1
135088	845.012-12 ES	R 1/2	12	29.3	22	ISO 7-1
135089	845.012-14 ES	R 1/2	14	34.5	22	ISO 7-1
135090	845.012-16 ES	R 1/2	16	33.6	24	ISO 7-1



845.014-10 ES



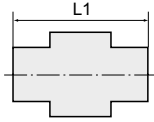

846.014-6 ES

Male connectors

stainless steel

Female connector, parallel male thread with outer hex

Art. No.	Type No.	Thread	For tube O.D. mm	L1 mm	a/f mm	Standard thread
135091	846.018-4 ES	G 1/8	4	28.8	13	DIN EN ISO 228-1
135092	846.018-6 ES	G 1/8	6	29.3	13	DIN EN ISO 228-1
135093	846.018-8 ES	G 1/8	8	29.8	16	DIN EN ISO 228-1
135094	846.014-4 ES	G 1/4	4	29.3	17	DIN EN ISO 228-1
135095	846.014-6 ES	G 1/4	6	30.8	17	DIN EN ISO 228-1
135096	846.014-8 ES	G 1/4	8	30.3	17	DIN EN ISO 228-1
135097	846.014-10 ES	G 1/4	10	31.3	17	DIN EN ISO 228-1
135098	846.014-12 ES	G 1/4	12	31.8	21	DIN EN ISO 228-1
135099	846.038-8 ES	G 3/8	8	30.8	21	DIN EN ISO 228-1
135100	846.038-10 ES	G 3/8	10	30.8	21	DIN EN ISO 228-1
135101	846.038-12 ES	G 3/8	12	32.2	21	DIN EN ISO 228-1
135102	846.038-14 ES	G 3/8	14	33.2	22	DIN EN ISO 228-1
135103	846.012-10 ES	G 1/2	10	33.6	27	DIN EN ISO 228-1
135104	846.012-12 ES	G 1/2	12	35.0	27	DIN EN ISO 228-1
135105	846.012-14 ES	G 1/2	14	36.0	27	DIN EN ISO 228-1
135106	846.012-16 ES	G 1/2	16	35.4	27	DIN EN ISO 228-1

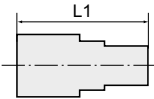

850.014-6 ES

Male connector, conical male thread with inner hex, round

Art. No.	Type No.	Thread	For tube O.D. mm	L1 mm	Hexagon socket head mm	Standard thread
135107	850.018-4 ES	R 1/8	4	22.8	3	ISO 7-1
135108	850.018-6 ES	R 1/8	6	23.0	4	ISO 7-1
135109	850.018-8 ES	R 1/8	8	25.8	5	ISO 7-1
135110	850.014-4 ES	R 1/4	4	23.3	3	ISO 7-1
135111	850.014-6 ES	R 1/4	6	23.0	4	ISO 7-1
135112	850.014-8 ES	R 1/4	8	26.3	6	ISO 7-1
135113	850.014-10 ES	R 1/4	10	29.3	6	ISO 7-1
135114	850.014-12 ES	R 1/4	12	31.0	6	ISO 7-1
135115	850.038-8 ES	R 3/8	8	24.3	6	ISO 7-1
135116	850.038-10 ES	R 3/8	10	26.8	8	ISO 7-1
135117	850.038-12 ES	R 3/8	12	27.7	8	ISO 7-1
135118	850.038-14 ES	R 3/8	14	32.5	10	ISO 7-1
135119	850.012-10 ES	R 1/2	10	27.8	8	ISO 7-1
135120	850.012-12 ES	R 1/2	12	28.2	10	ISO 7-1
135121	850.012-14 ES	R 1/2	14	32.0	10	ISO 7-1
135122	850.012-16 ES	R 1/2	16	32.0	12	ISO 7-1

Male elbows

stainless steel

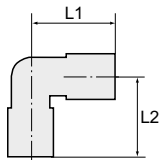

843.014-8 ES

Run tee, swivel type, parallel male thread with O-ring (FPM)

Art. No.	Type No.	Thread	For tube O.D. mm	L1 mm	L2 mm	a/f mm	Standard thread
135123	843.005-4 ES	M5	4	20.3	24.0	11	DIN 13-1
135124	843.018-4 ES	G 1/8	4	20.3	24.9	14	DIN EN ISO 228-1
135125	843.018-6 ES	G 1/8	6	22.0	26.0	14	DIN EN ISO 228-1
135126	843.018-8 ES	G 1/8	8	23.2	27.0	14	DIN EN ISO 228-1
135127	843.014-4 ES	G 1/4	4	20.3	26.8	17	DIN EN ISO 228-1
135128	843.014-6 ES	G 1/4	6	22.0	28.0	17	DIN EN ISO 228-1
135129	843.014-8 ES	G 1/4	8	23.2	29.0	17	DIN EN ISO 228-1

Male elbows

stainless steel

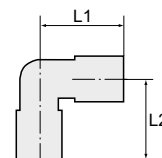

Run tee, swivel type, parallel male thread with O-ring (FPM)							
Art. No.	Type No.	Thread	For tube O.D. mm	L1 mm	L2 mm	a/f mm	Standard thread
135130	843.014-10 ES	G 1/4	10	24.3	30.3	17	DIN EN ISO 228-1
135131	843.014-12 ES	G 1/4	12	26.7	32.8	19	DIN EN ISO 228-1
135132	843.038-8 ES	G 3/8	8	23.2	29.5	21	DIN EN ISO 228-1
135133	843.038-10 ES	G 3/8	10	24.3	30.7	21	DIN EN ISO 228-1
135134	843.038-12 ES	G 3/8	12	26.7	32.6	21	DIN EN ISO 228-1
135135	843.038-14 ES	G 3/8	14	28.7	35.4	22	DIN EN ISO 228-1
135136	843.012-10 ES	G 1/2	10	24.3	33.8	27	DIN EN ISO 228-1
135137	843.012-12 ES	G 1/2	12	26.7	35.8	27	DIN EN ISO 228-1
135138	843.012-14 ES	G 1/2	14	28.7	38.4	27	DIN EN ISO 228-1
135139	843.012-16 ES	G 1/2	16	30.0	39.6	27	DIN EN ISO 228-1

Run tee, swivel type, conical male thread							
Art. No.	Type No.	Thread	For tube O.D. mm	L1 mm	L2 mm	a/f mm	Standard thread
135140	854.018-4 ES	R 1/8	4	20.3	25.6	11	ISO 7-1
135141	854.018-6 ES	R 1/8	6	22.0	26.8	13	ISO 7-1
135142	854.018-8 ES	R 1/8	8	23.2	27.8	14	ISO 7-1
135143	854.014-4 ES	R 1/4	4	20.3	29.3	14	ISO 7-1
135144	854.014-6 ES	R 1/4	6	22.0	30.5	14	ISO 7-1
135145	854.014-8 ES	R 1/4	8	23.2	31.5	14	ISO 7-1
135146	854.014-10 ES	R 1/4	10	24.3	33.0	16	ISO 7-1
135147	854.014-12 ES	R 1/4	12	26.7	35.1	19	ISO 7-1
135148	854.038-8 ES	R 3/8	8	23.2	32.3	17	ISO 7-1
135149	854.038-10 ES	R 3/8	10	24.3	33.7	17	ISO 7-1
135150	854.038-12 ES	R 3/8	12	26.7	35.6	19	ISO 7-1
135151	854.038-14 ES	R 3/8	14	28.7	38.5	22	ISO 7-1
135152	854.012-10 ES	R 1/2	10	24.3	37.5	22	ISO 7-1
135153	854.012-12 ES	R 1/2	12	26.7	39.4	22	ISO 7-1
135154	854.012-14 ES	R 1/2	14	28.7	42.2	22	ISO 7-1
135155	854.012-16 ES	R 1/2	16	30.0	43.5	24	ISO 7-1



854.014-8 ES

Run tee, conical male thread							
Art. No.	Type No.	Thread	For tube O.D. mm	L1 mm	L2 mm	a/f mm	Standard thread
135156	852.018-4 ES	R 1/8	4	20.3	16.0	10	ISO 7-1
135157	852.018-6 ES	R 1/8	6	22.0	17.2	12	ISO 7-1
135158	852.018-8 ES	R 1/8	8	23.2	18.2	14	ISO 7-1
135159	852.014-4 ES	R 1/4	4	22.6	21.7	14	ISO 7-1
135160	852.014-6 ES	R 1/4	6	23.2	22.0	14	ISO 7-1
135161	852.014-8 ES	R 1/4	8	23.2	21.7	14	ISO 7-1
135162	852.014-10 ES	R 1/4	10	24.3	23.0	16	ISO 7-1
135163	852.014-12 ES	R 1/4	12	26.7	24.5	19	ISO 7-1
135164	852.038-8 ES	R 3/8	8	24.3	23.3	16	ISO 7-1
135165	852.038-10 ES	R 3/8	10	24.3	23.0	16	ISO 7-1
135166	852.038-12 ES	R 3/8	12	26.7	25.0	19	ISO 7-1
135167	852.038-14 ES	R 3/8	14	28.0	26.0	21	ISO 7-1
135168	852.012-10 ES	R 1/2	10	26.7	29.5	21	ISO 7-1
135169	852.012-12 ES	R 1/2	12	27.7	29.5	21	ISO 7-1
135170	852.012-14 ES	R 1/2	14	28.0	29.5	21	ISO 7-1
135171	852.012-16 ES	R 1/2	16	30.2	31.5	24	ISO 7-1



852.038-10 ES



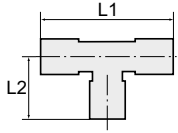

Male branch tees

stainless steel



855.014-6 ES

Male branch tee, swivel type, parallel male thread with O-ring (FPM)

Art. No.	Type No.	Thread	For tube O.D. mm	L1 mm	L2 mm	a/f mm	Standard thread
135172	855.005-4 ES	M5	4	40.6	24.0	11	DIN 13-1
135173	855.018-4 ES	G 1/8	4	40.6	24.9	14	DIN EN ISO 228-1
135174	855.018-6 ES	G 1/8	6	44.2	26.0	14	DIN EN ISO 228-1
135175	855.018-8 ES	G 1/8	8	46.4	27.0	14	DIN EN ISO 228-1
135176	855.014-4 ES	G 1/4	4	40.6	26.8	17	DIN EN ISO 228-1
135177	855.014-6 ES	G 1/4	6	44.2	28.0	17	DIN EN ISO 228-1
135178	855.014-8 ES	G 1/4	8	46.4	29.0	17	DIN EN ISO 228-1
135179	855.014-10 ES	G 1/4	10	48.6	30.3	17	DIN EN ISO 228-1
135180	855.014-12 ES	G 1/4	12	53.4	32.8	19	DIN EN ISO 228-1
135181	855.038-8 ES	G 3/8	8	46.4	29.5	21	DIN EN ISO 228-1
135182	855.038-10 ES	G 3/8	10	48.6	30.7	21	DIN EN ISO 228-1
135183	855.038-12 ES	G 3/8	12	53.4	32.6	21	DIN EN ISO 228-1
135184	855.038-14 ES	G 3/8	14	57.4	35.4	22	DIN EN ISO 228-1
135185	855.012-10 ES	G 1/2	10	48.6	33.8	27	DIN EN ISO 228-1
135186	855.012-12 ES	G 1/2	12	53.4	35.8	27	DIN EN ISO 228-1
135187	855.012-14 ES	G 1/2	14	57.4	38.4	27	DIN EN ISO 228-1
135188	855.012-16 ES	G 1/2	16	60.0	39.6	27	DIN EN ISO 228-1



8755.014-8 ES

Male branch tee, swivel type, conical male thread

Art. No.	Type No.	Thread	For tube O.D. mm	L1 mm	L2 mm	a/f mm	Standard thread
135189	8755.018-4 ES	R 1/8	4	40.6	25.6	11	ISO 7-1
135190	8755.018-6 ES	R 1/8	6	44.0	26.8	13	ISO 7-1
135191	8755.018-8 ES	R 1/8	8	46.4	27.8	14	ISO 7-1
135192	8755.014-4 ES	R 1/4	4	40.6	29.3	14	ISO 7-1
135193	8755.014-6 ES	R 1/4	6	44.0	30.5	14	ISO 7-1
135194	8755.014-8 ES	R 1/4	8	46.4	31.5	14	ISO 7-1
135195	8755.014-10 ES	R 1/4	10	48.6	33.0	16	ISO 7-1
135196	8755.014-12 ES	R 1/4	12	53.4	35.0	19	ISO 7-1
135197	8755.038-8 ES	R 3/8	8	46.4	32.3	17	ISO 7-1
135198	8755.038-10 ES	R 3/8	10	48.6	33.7	17	ISO 7-1
135199	8755.038-12 ES	R 3/8	12	53.4	35.6	19	ISO 7-1
135200	8755.038-14 ES	R 3/8	14	57.4	38.5	22	ISO 7-1
135201	8755.012-10 ES	R 1/2	10	48.6	37.5	22	ISO 7-1
135202	8755.012-12 ES	R 1/2	12	53.4	39.4	22	ISO 7-1
135203	8755.012-14 ES	R 1/2	14	57.4	42.2	22	ISO 7-1
135204	8755.012-16 ES	R 1/2	16	60.0	43.5	24	ISO 7-1

Male branch tees, angled plug connections

stainless steel

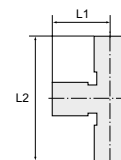

871.018-6 ES

Male branch tee, angled plug connections, swivel type, parallel male thread with O-ring (FPM)							
Art. No.	Type No.	Thread	For tube O.D. mm	L1 mm	L2 mm	a/f mm	Standard thread
135209	871.005-4 ES	M5	4	20.3	44.3	11	DIN 13-1
135210	871.018-4 ES	G 1/8	4	20.3	45.2	14	DIN EN ISO 228-1
135211	871.018-6 ES	G 1/8	6	22.1	48.1	14	DIN EN ISO 228-1
135212	871.018-8 ES	G 1/8	8	23.2	50.2	14	DIN EN ISO 228-1
135213	871.014-4 ES	G 1/4	4	20.3	47.1	17	DIN EN ISO 228-1
135214	871.014-6 ES	G 1/4	6	22.1	50.1	17	DIN EN ISO 228-1
135215	871.014-8 ES	G 1/4	8	23.2	52.2	17	DIN EN ISO 228-1
135216	871.014-10 ES	G 1/4	10	24.3	54.6	17	DIN EN ISO 228-1
135217	871.014-12 ES	G 1/4	12	26.7	59.5	19	DIN EN ISO 228-1
135218	871.038-8 ES	G 3/8	8	23.2	52.7	21	DIN EN ISO 228-1
135219	871.038-10 ES	G 3/8	10	24.3	55.0	21	DIN EN ISO 228-1
135220	871.038-12 ES	G 3/8	12	26.7	59.3	21	DIN EN ISO 228-1
135221	871.038-14 ES	G 3/8	14	28.7	64.1	22	DIN EN ISO 228-1
135222	871.012-10 ES	G 1/2	10	24.3	58.1	27	DIN EN ISO 228-1
135223	871.012-12 ES	G 1/2	12	26.7	62.5	27	DIN EN ISO 228-1
135224	871.012-14 ES	G 1/2	14	28.7	67.1	27	DIN EN ISO 228-1
135225	871.012-16 ES	G 1/2	16	30.0	69.6	27	DIN EN ISO 228-1

Male branch tee, angled plug connections, swivel type, conical male thread							
Art. No.	Type No.	Thread	For tube O.D. mm	L1 mm	L2 mm	a/f mm	Standard thread
135226	872.018-4 ES	R 1/8	4	20.3	45.9	11	ISO 7-1
135227	872.018-6 ES	R 1/8	6	22.1	48.9	13	ISO 7-1
135228	872.018-8 ES	R 1/8	8	23.2	51.0	14	ISO 7-1
135229	872.014-4 ES	R 1/4	4	20.3	49.6	14	ISO 7-1
135230	872.014-6 ES	R 1/4	6	22.1	52.6	14	ISO 7-1
135231	872.014-8 ES	R 1/4	8	23.2	54.7	14	ISO 7-1
135232	872.014-10 ES	R 1/4	10	24.3	57.3	16	ISO 7-1
135233	872.014-12 ES	R 1/4	12	26.7	61.7	19	ISO 7-1
135234	872.038-8 ES	R 3/8	8	23.2	55.5	17	ISO 7-1
135235	872.038-10 ES	R 3/8	10	24.3	58.0	17	ISO 7-1
135236	872.038-12 ES	R 3/8	12	26.7	62.3	19	ISO 7-1
135237	872.038-14 ES	R 3/8	14	28.7	67.2	22	ISO 7-1
135238	872.012-10 ES	R 1/2	10	24.3	61.8	22	ISO 7-1
135239	872.012-12 ES	R 1/2	12	26.7	66.1	22	ISO 7-1
135240	872.012-14 ES	R 1/2	14	28.7	70.9	22	ISO 7-1
135241	872.012-16 ES	R 1/2	16	30.0	73.5	24	ISO 7-1



872.014-6 ES



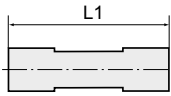

Unions

stainless steel



847.010 ES



847.0806 ES

Union				
Art. No.	Type No.	For tube O.D. mm	L1 mm	
135242	847.004 ES	4	34.6	
135243	847.006 ES	6	35.6	
135244	847.008 ES	8	35.6	
135245	847.010 ES	10	35.6	
135246	847.012 ES	12	38.8	
135247	847.014 ES	14	40.8	
135248	847.016 ES	16	40.8	
135249	847.0604 ES	6/4	35.5	
135250	847.0806 ES	8/6	36.0	

Reducer				
Art. No.	Type No.	For tube O.D. mm	L1 mm	
135251	847.1008 ES	10/8	36.0	
135252	847.1210 ES	12/10	37.4	
135253	847.1412 ES	14/12	39.8	
135254	847.1612 ES	16/12	39.4	

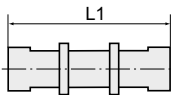

Female bulkhead connectors

stainless steel



851.018-10 ES

Female bulkhead connector					
Art. No.	Type No.	Thread	For tube O.D. mm	L1 mm	a/f mm
135255	851.011-4 ES	M11x0.75	4	33.0	14
135256	851.014-6 ES	M14x1.0	6	35.0	19
135257	851.016-8 ES	M16x1.0	8	36.0	21
135258	851.018-10 ES	M18x1.0	10	42.0	22
135259	851.022-12 ES	M22x1.5	12	46.4	27
135260	851.024-14 ES	M24x1.5	14	48.4	29
135261	851.026-16 ES	M26x1.5	16	48.4	30

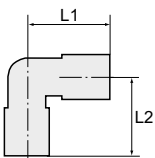

Union elbows

stainless steel



848.010 ES

Union elbow						
Art. No.	Type No.	For tube O.D. mm	L1 mm	L2 mm	a/f mm	
135262	848.004 ES	4	20.3	20.3	10	
135263	848.006 ES	6	22.0	22.0	12	
135264	848.008 ES	8	23.2	23.2	14	
135265	848.010 ES	10	24.3	24.3	16	
135266	848.012 ES	12	26.7	26.7	19	
135267	848.014 ES	14	28.7	28.7	22	
135268	848.016 ES	16	30.0	30.0	24	

Union tees

stainless steel

Union tee						
Art. No.	Type No.	For tube O.D. mm	L1 mm	L2 mm	a/f mm	
135269	849.004 ES	4	40.6	20.3	10	
135270	849.006 ES	6	44.0	22.0	12	
135271	849.008 ES	8	46.4	23.2	14	
135272	849.010 ES	10	48.6	24.3	16	
135273	849.012 ES	12	53.4	26.7	19	
135274	849.014 ES	14	57.4	28.7	22	
135275	849.016 ES	16	60.0	30.0	24	

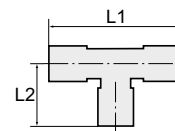

849.010 ES

X-unions

stainless steel

X-union				
Art. No.	Type No.	For tube O.D. mm	L1 mm	
135276	860.004 ES	4	20.3	
135277	860.006 ES	6	22.0	
135278	860.008 ES	8	23.2	
135279	860.010 ES	10	24.3	
135280	860.012 ES	12	26.7	
135281	860.014 ES	14	28.7	
135282	860.016 ES	16	30.0	

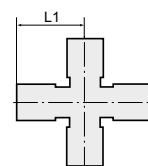

860.008 ES

Reducers with push-in plug

stainless steel

Reducer with push-in plug				
Art. No.	Type No.	Plug connection mm	For tube O.D. mm	L1 mm
135283	859.0604 ES	6	4	41.8
135284	859.0804 ES	8	4	41.8
135285	859.0806 ES	8	6	41.8
135286	859.1006 ES	10	6	42.8
135287	859.1008 ES	10	8	42.8
135288	859.1208 ES	12	8	45.8
135289	859.1210 ES	12	10	46.3
135290	859.1412 ES	14	12	47.8
135291	859.1612 ES	16	12	47.8



859.1210 ES

→ Only recommended for use in combination with stainless steel quick connectors type 844 ff. Suitability testing for use with other series is the responsibility of the user.



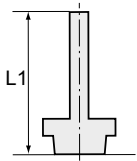

Push-in plug

stainless steel



768.014-10 ES



770.014-8 ES

Push-in plug, parallel male thread with O-ring (FPM)

Art. No.	Type No.	Thread	Plug connection mm	L1 mm	a/f mm	Standard thread
135292	768.005-4 ES	M5	4	34.0	11	DIN 13-1
135293	768.018-4 ES	G 1/8	4	34.8	14	DIN EN ISO 228-1
135294	768.018-6 ES	G 1/8	6	37.0	14	DIN EN ISO 228-1
135295	768.018-8 ES	G 1/8	8	37.0	14	DIN EN ISO 228-1
135296	768.014-4 ES	G 1/4	4	36.7	17	DIN EN ISO 228-1
135297	768.014-6 ES	G 1/4	6	39.2	17	DIN EN ISO 228-1
135298	768.014-8 ES	G 1/4	8	39.2	17	DIN EN ISO 228-1
135299	768.014-10 ES	G 1/4	10	39.2	17	DIN EN ISO 228-1
135300	768.014-12 ES	G 1/4	12	41.2	17	DIN EN ISO 228-1
135301	768.038-8 ES	G 3/8	8	39.4	21	DIN EN ISO 228-1
135302	768.038-10 ES	G 3/8	10	39.4	21	DIN EN ISO 228-1
135303	768.038-12 ES	G 3/8	12	41.2	21	DIN EN ISO 228-1
135304	768.038-14 ES	G 3/8	14	42.2	21	DIN EN ISO 228-1
135305	768.012-10 ES	G 1/2	10	42.2	27	DIN EN ISO 228-1
135306	768.012-12 ES	G 1/2	12	44.4	27	DIN EN ISO 228-1
135307	768.012-14 ES	G 1/2	14	45.8	27	DIN EN ISO 228-1
135308	768.012-16 ES	G 1/2	16	45.8	27	DIN EN ISO 228-1

Push-in plug, conical male thread

Art. No.	Type No.	Thread	Plug connection mm	L1 mm	a/f mm	Standard thread
135309	770.018-4 ES	R 1/8	4	36.5	11	ISO 7-1
135310	770.018-6 ES	R 1/8	6	38.5	11	ISO 7-1
135311	770.018-8 ES	R 1/8	8	38.5	11	ISO 7-1
135312	770.014-4 ES	R 1/4	4	40.0	14	ISO 7-1
135313	770.014-6 ES	R 1/4	6	42.0	14	ISO 7-1
135314	770.014-8 ES	R 1/4	8	42.0	14	ISO 7-1
135315	770.014-10 ES	R 1/4	10	42.0	14	ISO 7-1
135316	770.014-12 ES	R 1/4	12	44.5	14	ISO 7-1
135317	770.038-8 ES	R 3/8	8	42.5	17	ISO 7-1
135318	770.038-10 ES	R 3/8	10	42.5	17	ISO 7-1
135319	770.038-12 ES	R 3/8	12	45.0	17	ISO 7-1
135320	770.038-14 ES	R 3/8	14	47.0	17	ISO 7-1
135321	770.012-10 ES	R 1/2	10	46.5	22	ISO 7-1
135322	770.012-12 ES	R 1/2	12	48.5	22	ISO 7-1
135323	770.012-14 ES	R 1/2	14	50.5	22	ISO 7-1
135324	770.012-16 ES	R 1/2	16	50.5	22	ISO 7-1

→ Only recommended for use in combination with stainless steel quick connectors type 844 ff. Suitability testing for use with other series is the responsibility of the user.

Screw fittings

nickel-plated brass

Material	Nickel-plated brass
Max. working pressure	18 bar
Operating pressure	-20 °C to 80 °C (NBR O-Ring) -20 °C to 130 °C (FKM O-Ring) -20 °C to 300 °C (without sealant)

Unions

nickel-plated brass

EASY

Male connector, parallel male thread with O-ring (NBR)

Art. No.	Type No.	Thread	For hose mm	L1 mm	a/f mm
110468	11.105-4	M5	4/2	23.0	9
110470	11.105-6	M5	6/4	23.0	9
110472	11.118-6	G 1/8	6/4	25.0	13
110473	11.118-8	G 1/8	8/6	25.0	14
110475	11.114-6	G 1/4	6/4	27.0	16
110476	11.114-8	G 1/4	8/6	27.0	16
110477	11.114-10	G 1/4	10/8	29.0	16
110479	11.138-8	G 3/8	8/6	29.0	19
110480	11.138-10	G 3/8	10/8	31.0	19
110481	11.138-12	G 3/8	12/10	33.0	19
110482	11.112-6	G 1/2	6/4	32.0	24
110483	11.112-8	G 1/2	8/6	32.0	24
110484	11.112-10	G 1/2	10/8	33.0	24
110485	11.112-12	G 1/2	12/10	35.0	24

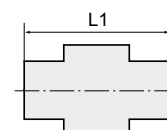

11.114-8

Male connector, parallel male thread without O-ring

Art. No.	Type No.	Thread	For hose mm	L1 mm	a/f mm
110469	11.105-5	M5	5/3	20.0	8
110471	11.118-5	G 1/8	5/3	23.0	14
110474	11.118-10	G 1/8	10/8	27.0	14
110478	11.138-6	G 3/8	6/4	29.0	19



11.118-5

Male connector, conical male thread acc. to ISO 7-1

Art. No.	Type No.	Thread	For hose mm	L1 mm	a/f mm
110486	11.618-4	R 1/8	4/2	41.0	10
110487	11.618-5	R 1/8	5/3	25.0	12
110488	11.618-6	R 1/8	6/4	26.5	12
110489	11.618-8	R 1/8	8/6	26.5	12
110490	11.618-10	R 1/8	10/8	29.5	14
110491	11.614-6	R 1/4	6/4	30.0	14
110492	11.614-8	R 1/4	8/6	30.0	14
110493	11.614-10	R 1/4	10/8	32.0	14
110494	11.638-6	R 3/8	6/4	31.5	17
110495	11.638-8	R 3/8	8/6	31.0	17
110496	11.638-10	R 3/8	10/8	33.0	17
110497	11.638-12	R 3/8	12/10	35.0	17
110498	11.612-8	R 1/2	8/6	34.5	22
110499	11.612-10	R 1/2	10/8	36.0	22
110500	11.612-12	R 1/2	12/10	38.0	22

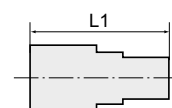

11.614-8



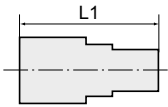

Unions

nickel-plated brass

EASY

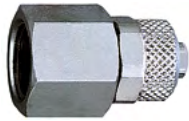

11.514-8



11.538-6

Female connector, female thread

Art. No.	Type No.	Thread	For hose mm	L1 mm	a/f mm
110501	11.518-6	G 1/8	6/4	26.5	14
110502	11.518-8	G 1/8	8/6	26.5	14
110503	11.514-6	G 1/4	6/4	29.5	17
110504	11.514-8	G 1/4	8/6	29.0	17
110505	11.514-10	G 1/4	10/8	31.0	17
110506	11.538-6	G 3/8	6/4	29.5	20
110507	11.538-8	G 3/8	8/6	33.0	20
110508	11.538-10	G 3/8	10/8	35.0	20
110509	11.538-12	G 3/8	12/10	32.5	20
110510	11.512-8	G 1/2	8/6	30.0	24
110511	11.512-10	G 1/2	10/8	38.0	24

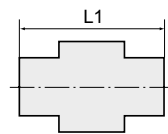

Unions

nickel-plated brass

EASY



11.114-8-V

Male connector, parallel male thread with O-ring (FPM)

Art. No.	Type No.	Thread	For hose mm	L1 mm	a/f mm
110512	11.118-6-V	G 1/8	6/4	25.0	13
110513	11.118-8-V	G 1/8	8/6	25.0	14
110514	11.114-6-V	G 1/4	6/4	27.0	16
110515	11.114-8-V	G 1/4	8/6	27.0	16
110516	11.114-10-V	G 1/4	10/8	29.0	16



Unions

nickel-plated brass

EASY



11.300-8

Union

Art. No.	Type No.	For hose mm	L1 mm	a/f mm
110517	11.300-4	4/2	41.0	10
110518	11.300-5	5/3	28.5	8
110519	11.300-6	6/4	33.0	12
110520	11.300-8	8/6	33.0	12
110521	11.300-10	10/8	37.0	14
110522	11.300-12	12/10	42.0	17



11.300-86

Union, reduced

Art. No.	Type No.	For hose mm	L1 mm	a/f mm
110523	11.300-86	8/6 - 6/4	35.0	14

Bulkhead connectors

nickel-plated brass

EASY

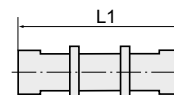

Bulkhead connector					
Art. No.	Type No.	Thread	For hose mm	L1 mm	a/f mm
110524	12.500-5	M7x0.75	5/3	40.0	9
110525	12.500-6	M10x1.0	6/4	47.0	14
110526	12.500-8	M12x1.0	8/6	48.0	16
110527	12.500-10	M14x1.0	10/8	49.0	17
110528	12.500-12	M16x1.0	12/10	53.0	19



Union elbows

nickel-plated brass

EASY

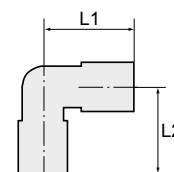

Male elbow, conical male thread, acc. to ISO 7-1							
Art. No.	Type No.	Thread	For hose mm	L1 mm	L2 mm	a/f mm	O-ring
110529	13.118-4	R 1/8	4/2	24.5	16.0	9	without
110530	13.118-5	R 1/8	5/3	21.5	17.0	8	without
110531	13.118-6	R 1/8	6/4	22.0	17.0	9	without
110532	13.118-8	R 1/8	8/6	22.0	17.0	12	without
110533	13.118-10	R 1/8	10/8	25.5	18.5	11	without
110534	13.114-6	R 1/4	6/4	22.0	20.0	9	without
110535	13.114-8	R 1/4	8/6	22.0	20.0	12	without
110536	13.114-10	R 1/4	10/8	25.0	21.0	12	without
110537	13.138-6	R 3/8	6/4	23.5	22.5	11	without
110538	13.138-8	R 3/8	8/6	23.0	21.5	12	without
110539	13.138-10	R 3/8	10/8	25.0	21.5	12	without
110540	13.138-12	R 3/8	12/10	31.0	24.0	14	without
110541	13.112-8	R 1/2	8/6	23.5	28.0	16	without
110542	13.112-10	R 1/2	10/8	28.5	26.0	17	without
110543	13.112-12	R 1/2	12/10	31.0	26.0	17	without



Male elbow, parallel male thread							
Art. No.	Type No.	Thread	For hose mm	L1 mm	L2 mm	a/f mm	O-ring
110544	13.505-5	M5	5/3	21.5	15.0	8	Without, non swivel type
110545	13.518-6	G 1/8	6/4	20.5	21.0	13	NBR, swivel type
110546	13.518-8	G 1/8	8/6	21.0	21.0	13	NBR, swivel type
110547	13.514-6	G 1/4	6/4	21.5	22.5	16	NBR, swivel type
110548	13.514-8	G 1/4	8/6	22.0	24.0	16	NBR, swivel type
110549	13.514-10	G 1/4	10/8	24.0	24.0	16	NBR, swivel type



Female elbow							
Art. No.	Type No.	Thread	For hose mm	L1 mm	L2 mm	a/f mm	O-ring
110550	13.718-5	G 1/8	5/3	21.5	19.0	10	without
110551	13.718-6	G 1/8	6/4	22.5	19.0	10	without
110552	13.718-8	G 1/8	8/6	22.5	19.0	10	without
110553	13.714-6	G 1/4	6/4	25.0	23.0	11	without
110554	13.714-8	G 1/4	8/6	25.0	23.0	11	without
110555	13.714-10	G 1/4	10/8	26.0	23.5	13	without
110556	13.738-12	G 3/8	12/10	30.5	28.0	17	without



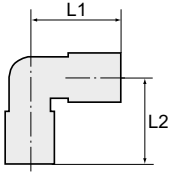

Male elbows

nickel-plated brass

EASY



13.514-8-V

Male elbow, swivel type, parallel male thread with O-ring (FPM)

Art. No.	Type No.	Thread	For hose mm	L1 mm	L2 mm	a/f mm
110557	13.518-6-V	G 1/8	6/4	20.5	21.0	10
110558	13.518-8-V	G 1/8	8/6	21.0	21.0	10
110559	13.514-6-V	G 1/4	6/4	21.5	22.5	10
110560	13.514-8-V	G 1/4	8/6	22.0	24.0	12
110561	13.514-10-V	G 1/4	10/8	24.0	24.0	12

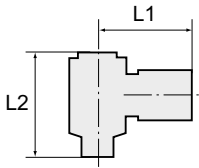

Banjo elbows

nickel-plated brass

EASY



13.614-8

Banjo elbow, parallel male thread with O-ring (NBR)

Art. No.	Type No.	Thread	For hose mm	L1 mm	L2 mm	a/f mm	Socket head
110562	13.605-5	M5	5/3	16.0	17.5	8	Male
110563	13.605-6	M5	6/4	16.0	17.5	8	Male
110564	13.618-5	G 1/8	5/3	24.0	28.0	14	Male
110565	13.618-6	G 1/8	6/4	24.0	28.0	14	Male
110566	13.618-8	G 1/8	8/6	24.0	28.0	14	Male
110567	13.618-10	G 1/8	10/8	24.0	28.0	14	Male
110568	13.614-6	G 1/4	6/4	26.0	33.0	17	Male
110569	13.614-8	G 1/4	8/6	26.0	33.0	17	Male
110570	13.614-10	G 1/4	10/8	27.5	33.0	17	Male
110571	13.638-6	G 3/8	6/4	26.0	36.0	19	Male
110572	13.638-8	G 3/8	8/6	28.5	37.0	20	Male
110573	13.638-10	G 3/8	10/8	29.0	37.0	20	Male
110574	13.638-12	G 3/8	12/10	31.5	36.0	5	Female
110575	13.612-8	G 1/2	8/6	29.0	42.0	24	Male
110576	13.612-10	G 1/2	10/8	30.5	42.0	27	Male
110577	13.612-12	G 1/2	12/10	33.0	42.0	8	Female

Union elbows

nickel-plated brass

EASY



13.800-8



13.800-86

Union elbow

Art. No.	Type No.	For hose mm	L1 mm	a/f mm
110578	13.800-4	4/2	24.5	9
110579	13.800-5	5/3	21.5	8
110580	13.800-6	6/4	22.0	9
110581	13.800-8	8/6	22.0	12
110582	13.800-10	10/8	25.0	12
110583	13.800-12	12/10	30.0	14

Union elbow, reduced

Art. No.	Type No.	For hose mm	L1 mm	a/f mm
110584	13.800-86	8/6 - 6/4	22.5	10

Branch tees

nickel-plated brass

EASY

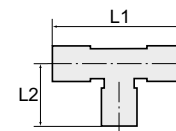

Male branch tee, conical male thread acc. to ISO 7-1

Art. No.	Type No.	Thread	For hose mm	L1 mm	L2 mm	a/f mm	O-ring
110585	14.118-4	R 1/8	4/2	49.0	16.0	9	without
110586	14.118-5	R 1/8	5/3	43.0	17.0	8	without
110587	14.118-6	R 1/8	6/4	44.0	17.0	8	without
110588	14.118-8	R 1/8	8/6	44.0	17.0	10	without
110589	14.118-10	R 1/8	10/8	51.0	18.5	11	without
110590	14.114-6	R 1/4	6/4	44.0	20.0	10	without
110591	14.114-8	R 1/4	8/6	44.0	20.0	10	without
110592	14.114-10	R 1/4	10/8	50.0	21.0	11	without
110593	14.138-8	R 3/8	8/6	46.0	22.0	11	without
110594	14.138-10	R 3/8	10/8	50.0	22.0	11	without
110595	14.138-12	R 3/8	12/10	62.0	24.0	14	without
110596	14.112-10	R 1/2	10/8	57.0	28.0	17	without
110597	14.112-12	R 1/2	12/10	62.0	26.0	17	without



14.114-8

Male branch tee, parallel male thread

Art. No.	Type No.	Thread	For hose mm	L1 mm	L2 mm	a/f mm	O-ring
110598	14.505-5	M5	5/3	43.0	15.0	8	Without, non-swivel type
110599	14.518-6	G 1/8	6/4	39.0	22.0	13	NBR, swivel type
110600	14.518-8	G 1/8	8/6	45.0	20.0	14	NBR, swivel type
110601	14.514-6	G 1/4	6/4	39.0	26.0	16	NBR, swivel type
110602	14.514-8	G 1/4	8/6	40.0	27.5	16	NBR, swivel type
110603	14.514-10	G 1/4	10/8	45.0	27.5	16	NBR, swivel type



14.514-8

Union tee

Art. No.	Type No.	For hose mm	L1 mm	a/f mm	O-ring
110604	14.800-4	4/2	49.0	9	without
110605	14.800-5	5/3	43.0	8	without
110606	14.800-6	6/4	44.0	9	without
110607	14.800-8	8/6	44.0	10	without
110608	14.800-10	10/8	50.0	12	without
110609	14.800-12	12/10	62.0	17	without



14.800-8



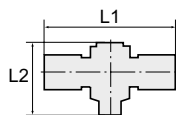

Banjo tees

nickel-plated brass

EASY



14.214-8

Banjo tee, parallel male thread with O-ring (NBR)

Art. No.	Type No.	Thread	For hose mm	L1 mm	L2 mm	a/f mm
110610	14.205-5	M5	5/3	33.0	17.5	8
110611	14.205-6	M5	6/4	33.0	17.5	8
110612	14.218-5	G 1/8	5/3	46.0	28.0	14
110613	14.218-6	G 1/8	6/4	49.0	28.0	14
110614	14.218-8	G 1/8	8/6	50.0	28.0	14
110615	14.218-10	G 1/8	10/8	53.0	28.0	14
110616	14.214-6	G 1/4	6/4	53.0	33.0	17
110617	14.214-8	G 1/4	8/6	52.0	33.0	17
110618	14.214-10	G 1/4	10/8	55.0	33.0	17
110619	14.238-6	G 3/8	6/4	53.0	36.0	19
110620	14.238-8	G 3/8	8/6	57.0	37.0	20
110621	14.238-10	G 3/8	10/8	58.0	37.0	20
110622	14.238-12	G 3/8	12/10	64.0	37.0	20
110623	14.212-10	G 1/2	10/8	61.0	42.0	27
110624	14.212-12	G 1/2	12/10	64.0	42.0	27

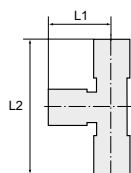

Male run tees

nickel-plated brass

EASY



15.114-8

Male run tee, conical male thread acc. to ISO 7-1

Art. No.	Type No.	Thread	For hose mm	L1 mm	L2 mm	a/f mm
110625	15.118-5	R 1/8	5/3	21.5	38.5	8
110626	15.118-6	R 1/8	6/4	22.0	39.0	9
110627	15.118-8	R 1/8	8/6	22.0	39.0	12
110628	15.114-6	R 1/4	6/4	22.0	42.0	9
110629	15.114-8	R 1/4	8/6	22.0	42.0	12
110630	15.114-10	R 1/4	10/8	25.5	41.0	11
110631	15.138-8	R 3/8	8/6	23.0	45.0	12
110632	15.138-10	R 3/8	10/8	25.0	47.0	12
110633	15.138-12	R 3/8	12/10	31.0	55.0	17
110634	15.112-10	R 1/2	10/8	28.5	54.5	17
110635	15.112-12	R 1/2	12/10	31.0	57.0	17

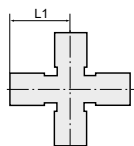

X-unions

nickel-plated brass

EASY



17.800-8

X-union

Art. No.	Type No.	For hose mm	L1 mm	a/f mm
110636	17.800-5	5/3	21.5	8
110637	17.800-6	6/4	22.5	8
110638	17.800-8	8/6	22.5	10
110639	17.800-10	10/8	25.5	12

Swivel nuts

nickel-plated brass

EASY

Swivel nut						
Art. No.	Type No.	Thread	For hose mm	L1 mm	a/f mm	
110640	16.008-4	M8x1.0	4/2	11.0	10	
110641	16.007-5	M7x0.75	5/3	8.5	8	
110642	16.008-6	M8x0.5	6/4	9.0	9	
110643	16.008-6.926	M8x0.75	6/4	11.0	8	
110644	16.010-6	M10x1.0	6/4	11.0	12	
110645	16.012-8	M12x1.0	8/6	11.0	14	
110646	16.014-10	M14x1.0	10/8	12.0	16	
110647	16.016-12	M16x1.0	12/10	12.0	19	



16.012-8

Adapter unions with kink protector

nickel-plated brass

EASY

Male connector, parallel male thread with O-ring (NBR) and kink protector					
Art. No.	Type No.	Thread	For hose mm	a/f mm	
110648	17.118-6	G 1/8	6/4	13	
110649	17.118-8	G 1/8	8/6	14	
110650	17.114-6	G 1/4	6/4	16	
110651	17.114-8	G 1/4	8/6	16	
110652	17.114-10	G 1/4	10/8	16	
110653	17.138-8	G 3/8	8/6	19	
110654	17.138-10	G 3/8	10/8	19	
110655	17.138-12	G 3/8	12/10	19	
110656	17.112-8	G 1/2	8/6	24	
110657	17.112-10	G 1/2	10/8	24	



17.138-8

Male connector, parallel male thread with O-ring (NBR) + kink protector, swivel type						
Art. No.	Type No.	Thread	For hose mm	a/f 1 mm	a/f 2 mm	
110658	18.118-6	G 1/8	6/4	12	13	
110659	18.118-8	G 1/8	8/6	14	13	
110660	18.114-6	G 1/4	6/4	12	16	
110661	18.114-8	G 1/4	8/6	14	16	
110662	18.114-10	G 1/4	10/8	16	16	
110663	18.138-12	G 3/8	12/10	18	19	



18.114-6

Swivel nuts with kink protector

nickel-plated brass

EASY

Swivel nut with kink protector				
Art. No.	Type No.	For hose mm	a/f mm	
110664	19.0604	6/4	12	
110665	19.0806	8/6	14	
110666	19.1008	10/8	16	
110667	19.1210	12/10	18	



19.0806



Screw fittings

stainless steel 1.4571

Unions

stainless steel 1.4571

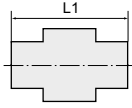

11.0414 ES

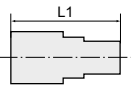

11.0551 ES

Male connector, parallel male thread

Art. No.	Type No.	Thread	For hose mm	L1 mm	a/f mm
110668	11.0412 ES	M5	5/3	20.0	8
110669	11.0413 ES	G 1/8	6/4	27.0	14
110670	11.0414 ES	G 1/8	8/6	29.0	14
110671	11.0416 ES	G 1/4	6/4	29.0	17
110672	11.0417-ES	G 1/4	8/6	31.0	17
110673	11.0418-ES	G 1/4	10/8	33.0	17
110674	11.0420 ES	G 3/8	8/6	33.0	19
110675	11.0421 ES	G 3/8	10/8	35.0	19
110676	11.0422 ES	G 3/8	12/9	35.0	19
110677	11.0425 ES	G 1/2	10/8	36.0	24
110678	11.0426 ES	G 1/2	12/9	36.0	24

Female connector, parallel female thread

Art. No.	Type No.	Thread	For hose mm	L1 mm	a/f mm
110679	11.0551 ES	G 1/4	6/4	25.0	17
110680	11.0552 ES	G 1/4	8/6	25.0	17

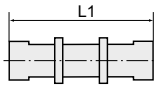

12.0530 ES

Bulkhead connectors

stainless steel 1.4571

Bulkhead connector

Art. No.	Type No.	Thread	For hose mm	L1 mm	a/f mm
110681	12.0530 ES	M10x1.0	6/4	44.0	14
110682	12.0531 ES	M12x1.0	8/6	50.0	17

Male elbows

stainless steel 1.4571

Male elbow, conical male thread acc. to ISO 7-1

Art. No.	Type No.	Thread	For hose mm	L1 mm	L2 mm	a/f mm
110683	13.111 ES	R 1/8	6/4	22.0	17.0	12
110684	13.112-ES	R 1/8	8/6	25.4	20.0	14
110685	13.213-ES	R 1/4	10/8	34.0	27.0	19

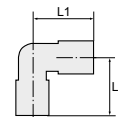

13.111 ES

Union tees

stainless steel 1.4571

Union tees

Art. No.	Type No.	For hose mm	L1 mm	L2 mm
110686	14.0771-ES	6/4	60.0	30.0
110687	14.0772 ES	8/6	63.0	32.0

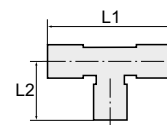

14.0771-ES

Screw fittings

stainless steel 1.4404

Supplied without seals. For use with corrosive media and at high temperatures.

Screw fitting series made of stainless steel for all applications where compliance with strict tightness, pressure and temperature requirements is essential. The parts are manufactured without rubber seals, in other words they are ideal for very high temperatures or for use with corrosive liquids, e.g. in cases when FPM is no longer suitable.

Material	Stainless steel 1.4404
Sealant	Pure metal
Max. working pressure	25 bar
Temperature range	-40 to 200 °C
Recommended hose	PTFE hose

Male connectors

stainless steel 1.4404

Male connector, conical male thread acc. to ISO 7-1, stainless steel

Art. No.	Type No.	Thread	For hose mm	L1 mm	a/f 1 mm	a/f 2 mm
110688	11.118-6 ESH	R 1/8	6/4	26.0	12	10
110689	11.118-8 ESH	R 1/8	8/6	26.5	14	13
110690	11.114-6 ESH	R 1/4	6/4	29.5	12	14
110691	11.114-8 ESH	R 1/4	8/6	30.0	14	14
110692	11.114-10 ESH	R 1/4	10/8	32.5	16	14
110693	11.138-10 ESH	R 3/8	10/8	33.0	16	17

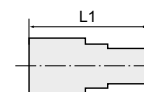

11.118-6 ESH



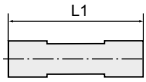

Unions

stainless steel 1.4404



11.300-6 ESH

Union, stainless steel

Art. No.	Type No.	For hose mm	L1 mm	a/f 1 mm	a/f 2 mm
110694	11.300-6 ESH	6/4	34.0	12	10
110695	11.300-8 ESH	8/6	35.0	14	12
110696	11.300-10 ESH	10/8	39.0	16	14

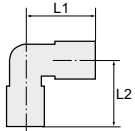

Male elbows

stainless steel 1.4404



13.114-8 ESH

Male elbow, conical male thread acc. to ISO 7-1, stainless steel

Art. No.	Type No.	Thread	For hose mm	L1 mm	L2 mm	a/f 1 mm	a/f 2 mm
110697	13.118-6 ESH	R 1/8	6/4	23.0	17.0	12	10
110698	13.118-8 ESH	R 1/8	8/6	23.0	17.0	14	10
110699	13.114-6 ESH	R 1/4	6/4	23.0	21.5	12	10
110700	13.114-8 ESH	R 1/4	8/6	23.0	21.5	14	10
110701	13.114-10 ESH	R 1/4	10/8	26.0	21.5	16	12

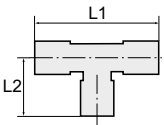

Male branch tees

stainless steel 1.4404



14.114-8 ESH

Male branch tee, conical male thread acc. to ISO 7-1, stainless steel

Art. No.	Type No.	Thread	For hose mm	L1 mm	L2 mm	a/f 1 mm	a/f 2 mm
110702	14.118-6 ESH	R 1/8	6/4	46.0	17.0	12	10
110703	14.118-8 ESH	R 1/8	8/6	46.0	17.0	14	10
110704	14.114-6 ESH	R 1/4	6/4	46.0	21.5	12	10
110705	14.114-8 ESH	R 1/4	8/6	46.0	21.5	14	10
110706	14.114-10 ESH	R 1/4	10/8	52.0	21.5	16	12

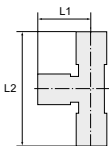

Male run tees

stainless steel 1.4404



15.114-6 ESH

Male run tee, conical male thread acc. to ISO 7-1, stainless steel

Art. No.	Type No.	Thread	For hose mm	L1 mm	L2 mm	a/f 1 mm	a/f 2 mm
110707	15.118-6 ESH	R 1/8	6/4	23.0	40.0	12	10
110708	15.118-8 ESH	R 1/8	8/6	23.0	40.0	14	10
110709	15.114-6 ESH	R 1/4	6/4	23.0	44.5	12	10
110710	15.114-8 ESH	R 1/4	8/6	23.0	44.5	14	10
110711	15.114-10 ESH	R 1/4	10/8	26.0	47.5	16	12

Union elbows

stainless steel 1.4404

Union elbow, stainless steel

Art. No.	Type No.	For hose mm	L1 mm	L2 mm	a/f 1 mm	a/f 2 mm
110712	13.800-6 ESH	6/4	22.5	22.5	12	10
110713	13.800-8 ESH	8/6	23.0	23.0	14	10
110714	13.800-10 ESH	10/8	26.0	26.0	16	10

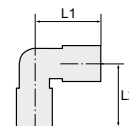

13.800-6 ESH

Union tees

stainless steel 1.4404

Union tee, stainless steel

Art. No.	Type No.	For hose mm	L1 mm	L2 mm	a/f 1 mm	a/f 2 mm
110715	14.800-6 ESH	6/4	46.0	22.5	12	10
110716	14.800-8 ESH	8/6	46.0	23.0	14	10
110717	14.800-10 ESH	10/8	52.0	26.0	16	12

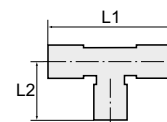

14.800-8 ESH

Swivel nuts

stainless steel 1.4404

Swivel nut, stainless steel

Art. No.	Type No.	Thread	For hose mm	a/f mm
110718	16.010-6 ESH	M10x1.0	6/4	12
110719	16.012-8 ESH	M12x1.0	8/6	14
110720	16.014-10 ESH	M14x1.0	10/8	16



16.012-8 ESH

→ For PTFE hoses please look at page 845



Tube fittings

plastic (POM) blue

Operating pressure 0 - 10 bar
Temperature range -10 to 60 °C

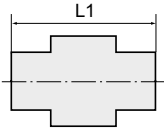

Male connectors

plastic (POM) blue

EASY



11.653

Male connector, parallel male thread

Art. No.	Type No.	Thread	For hose mm	L1 mm	a/f mm
110721	11.651	G 1/8	6/4	28.0	13
110722	11.652	G 1/8	8/6	29.5	13
110723	11.653	G 1/4	6/4	31.0	17
110724	11.654	G 1/4	8/6	32.0	17
110725	11.655	G 1/4	12/9	37.5	19
110726	11.656	G 1/4	10/8	34.0	17
110727	11.657	G 3/8	8/6	34.0	19
110728	11.658	G 3/8	10/8	35.5	19
110729	11.659	G 3/8	12/9	37.5	19

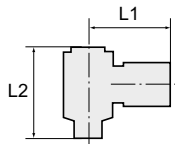

Union elbows

plastic (POM) blue

EASY



13.665

Union elbow with aluminium banjo bolt, swivel type

Art. No.	Type No.	Thread	For hose mm	L1 mm	L2 mm
110730	13.660	G 1/8	6/4	23.0	27.0
110731	13.661	G 1/8	8/6	25.0	27.0
110732	13.665	G 1/4	6/4	25.0	29.0
110733	13.666	G 1/4	8/6	26.5	29.0

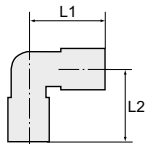

Union elbow, rigid, conical male thread acc. to ISO 7-1

Art. No.	Type No.	Thread	For hose mm	L1 mm	L2 mm
110734	13.760	R 1/8	6/4	23.0	16.0
110735	13.761	R 1/8	8/6	23.0	17.0
110736	13.765	R 1/4	6/4	24.0	19.0
110737	13.766	R 1/4	8/6	25.0	20.0
110738	13.768	R 1/4	12/9	28.0	23.0
110739	13.774	R 3/8	12/9	28.0	23.0



13.765

Branch tees

plastic (POM) blue

EASY

Branch tee with aluminium banjo bolt, swivel type

Art. No.	Type No.	Thread	For hose mm	L1 mm	L2 mm
110740	14.811	G 1/8	6/4	47.0	27.0
110741	14.812	G 1/8	8/6	49.0	27.0
110742	14.815	G 1/4	6/4	51.0	29.0
110743	14.816	G 1/4	8/6	53.0	29.0

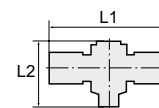

14.815

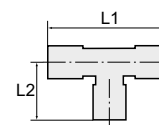

14.912

Union tee, rigid

Art. No.	Type No.	For hose mm	L1 mm	L2 mm
110744	14.911	6/4	52.0	26.0
110745	14.912	8/6	52.0	26.0
110746	14.913	12/9	63.0	32.0

Hose connectors

plastic (POM) blue

EASY

Hose connector

Art. No.	Type No.	For hose mm	L1 mm
110747	15.775	6/4	50.5
110748	15.776	8/6	51.3
110749	15.778	12/9	59.8

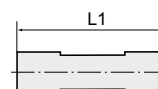

15.776

Bulkhead connectors

plastic (POM) blue

EASY

Bulkhead connector, complete with fixing nuts

Art. No.	Type No.	Thread	For hose mm	L1 mm	a/f mm
110750	15.885	M10x1.0	6/4	50.0	13
110751	15.886	M12x1.0	8/6	51.0	17
110752	15.888	M16x1.0	12/9	60.0	19

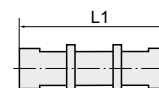

15.886



Clamping nuts

plastic (POM) blue

EASY



16/13

Clamping nut

Art. No.	Type No.	Thread	For hose mm	L1 mm	a/f mm
110755	16/14	M16x1.0	12/9	14.0	19
110756	16/15	M14x1.0	10/8	13.0	17

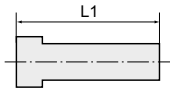

Banjo bolts

aluminium blue

EASY



14/11

Aluminium banjo bolt

Art. No.	Type No.	Thread	L1 mm	a/f mm
110757	14/11	G 1/8	27.0	14
110758	14/12	G 1/4	29.0	17

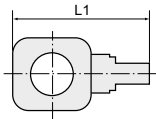

Single banjos

plastic (POM) blue

EASY



13/14

Single banjos

Art. No.	Type No.	Thread	For hose mm	L1 mm
110759	13/11	For G 1/8	6/4	31.0
110760	13/12	For G 1/8	8/6	33.0
110761	13/14	For G 1/4	6/4	35.0
110762	13/15	For G 1/4	8/6	36.5

Tube fittings

polyamide (PA)

Manufactured from high impact-resistant, UV-stabilised engineering plastic, extremely resistant to weathering. Good chemical resistance to benzene, diesel oil, fuel oil and alkalis. Not suitable for use with acids.

Screw fitting body	Polyamide (PA)
Clamping ring	Polypropylene (PP)
Knurled nut	Polypropylene (PP)
Max. Operating pressure at 20 °C	10 bar
Max. Operating pressure at 60 °C	1 bar

Unions

polyamide (PA)



Male connector with male G thread

Art. No.	Type No.	Thread	For hose mm	L1 mm	L2 mm	a/f mm
110763	120.01	G 1/8	4/6	31.5	8.0	14
110764	120.02	G 1/8	6/8	36.5	8.0	17
110765	120.03	G 1/8	8/10	40.5	8.0	19
110766	120.04	G 1/8	9/12	44.5	8.0	22
110767	120.11	G 1/4	4/6	37.0	12.0	17
110768	120.12	G 1/4	6/8	41.0	12.0	17
110769	120.13	G 1/4	8/10	45.0	12.0	19
110770	120.14	G 1/4	9/12	48.5	12.0	22
110771	120.21	G 3/8	4/6	38.5	12.0	22
110772	120.22	G 3/8	6/8	42.5	12.0	22
110773	120.23	G 3/8	8/10	45.5	12.0	22
110774	120.24	G 3/8	9/12	49.5	12.0	22
110775	120.31	G 1/2	4/6	43.0	14.0	27
110776	120.32	G 1/2	6/8	47.0	14.0	27
110777	120.33	G 1/2	8/10	50.0	14.0	27
110778	120.34	G 1/2	9/12	54.0	14.0	27

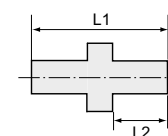

120.11

Female connector with female G thread

Art. No.	Type No.	Thread	For hose mm	L1 mm	L2 mm	a/f mm
110779	120.41	G 1/8	4/6	31.0	17.0	14
110780	120.42	G 1/8	6/8	36.0	21.0	17
110781	120.43	G 1/8	8/10	39.0	24.0	19
110782	120.44	G 1/8	9/12	43.0	28.0	22
110783	120.51	G 1/4	4/6	36.0	17.0	17
110784	120.52	G 1/4	6/8	41.0	21.0	17
110785	120.53	G 1/4	8/10	44.0	24.0	19
110786	120.54	G 1/4	9/12	48.0	28.0	22
110787	120.61	G 3/8	4/6	36.0	17.0	22
110788	120.62	G 3/8	6/8	41.0	21.0	22
110789	120.63	G 3/8	8/10	44.0	24.0	22
110790	120.64	G 3/8	9/12	48.0	28.0	22
110791	120.71	G 1/2	4/6	38.0	17.0	27
110792	120.72	G 1/2	6/8	42.0	21.0	27
110793	120.73	G 1/2	8/10	44.0	24.0	27
110794	120.74	G 1/2	9/12	49.0	28.0	27

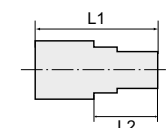

120.51



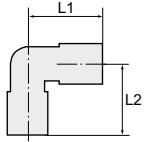

Union elbows

polyamide (PA)



140.61

Male elbow with male G thread

Art. No.	Type No.	Thread	For hose mm	L1 mm	L2 mm
110795	140.51	G 1/8	4/6	25.0	20.0
110796	140.52	G 1/8	6/8	30.0	23.0
110797	140.53	G 1/8	8/10	36.0	25.0
110798	140.54	G 1/8	9/12	40.0	27.0
110799	140.61	G 1/4	4/6	26.0	25.0
110800	140.62	G 1/4	6/8	30.0	27.0
110801	140.63	G 1/4	8/10	36.0	32.0
110802	140.64	G 1/4	9/12	40.0	31.0
110803	140.71	G 3/8	4/6	29.0	30.0
110804	140.72	G 3/8	6/8	33.0	27.0
110805	140.73	G 3/8	8/10	36.0	29.0
110806	140.74	G 3/8	9/12	40.0	31.0
110807	140.81	G 1/2	4/6	32.0	29.0
110808	140.82	G 1/2	6/8	36.0	29.0
110809	140.83	G 1/2	8/10	39.0	31.0
110810	140.84	G 1/2	9/12	43.0	33.0



150.11

Female elbow with female G thread

Art. No.	Type No.	Thread	For hose mm	L1 mm	L2 mm
110811	150.01	G 1/8	4/6	26.0	17.0
110812	150.02	G 1/8	6/8	29.0	17.0
110813	150.11	G 1/4	4/6	29.0	20.0
110814	150.12	G 1/4	6/8	32.0	20.0
110815	150.13	G 1/4	8/10	35.0	20.0

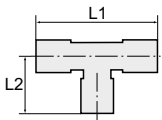

Male branch tees

polyamide (PA)



150.51

Male branch tee with male G thread

Art. No.	Type No.	Thread	For hose mm	L1 mm	L2 mm
110816	150.41	G 1/8	4/6	52.0	20.0
110817	150.42	G 1/8	6/8	62.0	20.0
110818	150.51	G 1/4	4/6	54.0	27.0
110819	150.52	G 1/4	6/8	62.0	27.0

Knurled nuts

polypropylene (PP)



Knurled nut				
Art. No.	Type No.	Thread	For hose mm	L1 mm
110820	160.01	M10x1.0	4/6	13.5
110821	160.02	M14x1.5	6/8	17.0
110822	160.03	M16x1.5	8/10	18.0
110823	160.04	M18x1.5	9/12	20.0



160.01

Clamping rings

polypropylene (PP)



Clamping ring				
Art. No.	Type No.	For hose mm	L1 mm	L1 mm
110824	170.01	4/6	6.0	6.0
110825	170.02	6/8	8.0	8.0
110826	170.03	8/10	10.0	10.0
110827	170.04	9/12	11.0	11.0



170.01

Hose connectors

polyamide (PA)



Hose connector				
Art. No.	Type No.	For hose mm	L1 mm	a/f mm
110828	140.01	4/6	39.0	14
110829	140.02	6/8	49.0	19
110830	140.03	8/10	55.0	22
110831	140.04	9/12	64.0	24

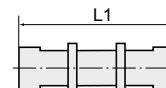

140.01

Elbow hose connectors

polyamide (PA)



Elbow hose connector				
Art. No.	Type No.	For hose mm	L1 mm	L2 mm
110832	140.11	4/6	25.0	25.0
110833	140.12	6/8	30.0	30.0
110834	140.13	8/10	36.0	36.0
110835	140.14	9/12	43.0	43.0

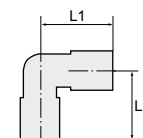

140.11

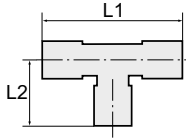

Tee hose connectors

polyamide (PA)



Tee hose connector

Art. No.	Type No.	For hose mm	L1 mm	L2 mm
110836	140.21	4/6	52.0	26.0
110837	140.22	6/8	62.0	31.0
110838	140.23	8/10	72.0	36.0
110839	140.24	9/12	80.0	40.0

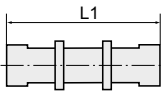

Bulkhead couplings

polyamide (PA)



Bulkhead coupling

Art. No.	Type No.	Thread	For hose mm	L1 mm	a/f mm
110840	140.31	M10x1.0	4/6	53.0	14
110841	140.32	M14x1.5	6/8	64.0	19
110842	140.33	M16x1.5	8/10	73.0	22
110843	140.34	M18x1.5	9/12	84.0	24

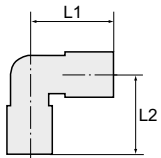

Bulkhead elbow couplings

polyamide (PA)



Bulkhead elbow coupling

Art. No.	Type No.	Thread	For hose mm	L1 mm	L2 mm	a/f mm
110844	140.41	M10x1.0	4/6	43.0	25.0	14
110845	140.42	M14x1.5	6/8	53.0	33.0	19
110846	140.43	M16x1.5	8/10	58.0	36.0	22
110847	140.44	M18x1.5	9/12	67.0	43.0	24

Tube fittings

polypropylene (PP)

Chemically resistant to almost all inorganic acids and bases, even in high concentrations and at temperatures greater than 90 °C.

Material	Polypropylene (PP)
Max. Operating pressure at 20 °C	10 bar
Max. Operating pressure at 90 °C	2.5 bar
Max. operating temperature	90 °C

Unions

polypropylene (PP)

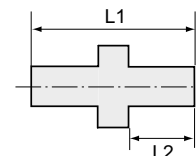

120.11-PP

Male connector with male G thread

Art. No.	Type No.	Thread	For hose mm	L1 mm	L2 mm	a/f mm
110848	120.01-PP	G 1/8	4/6	31.5	8.0	14
110849	120.02-PP	G 1/8	6/8	36.5	8.0	17
110850	120.03-PP	G 1/8	8/10	40.5	8.0	19
110851	120.04-PP	G 1/8	9/12	44.5	8.0	22
110852	120.11-PP	G 1/4	4/6	37.0	12.0	17
110853	120.12-PP	G 1/4	6/8	41.0	12.0	17
110854	120.13-PP	G 1/4	8/10	45.0	12.0	19
110855	120.14-PP	G 1/4	9/12	49.0	12.0	22
110856	120.21-PP	G 3/8	4/6	38.5	12.0	22
110857	120.22-PP	G 3/8	6/8	42.5	12.0	22
110858	120.23-PP	G 3/8	8/10	45.5	12.0	22
110859	120.24-PP	G 3/8	9/12	49.5	12.0	22
110860	120.31-PP	G 1/2	4/6	43.0	14.0	27
110861	120.32-PP	G 1/2	6/8	47.0	14.0	27
110862	120.33-PP	G 1/2	8/10	50.0	14.0	27
110863	120.34-PP	G 1/2	9/12	54.0	14.0	27

Union elbows

polypropylene (PP)

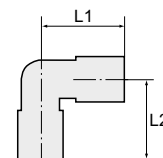

140.51-PP

Male elbow with male G thread

Art. No.	Type No.	Thread	For hose mm	L1 mm	L2 mm
110864	140.51-PP	G 1/8	4/6	25.0	20.0
110865	140.52-PP	G 1/8	6/8	30.0	23.0
110866	140.53-PP	G 1/8	8/10	36.0	25.0
110867	140.54-PP	G 1/8	9/12	40.0	27.0
110868	140.61-PP	G 1/4	4/6	26.0	25.0
110869	140.62-PP	G 1/4	6/8	30.0	27.0
110870	140.63-PP	G 1/4	8/10	36.0	32.0
110871	140.64-PP	G 1/4	9/12	40.0	31.0
110872	140.71-PP	G 3/8	4/6	29.0	30.0
110873	140.72-PP	G 3/8	6/8	33.0	27.0
110874	140.73-PP	G 3/8	8/10	36.0	29.0
110875	140.74-PP	G 3/8	9/12	40.0	31.0
110876	140.81-PP	G 1/2	4/6	32.0	29.0
110877	140.82-PP	G 1/2	6/8	36.0	29.0
110878	140.83-PP	G 1/2	8/10	39.0	31.0
110879	140.84-PP	G 1/2	9/12	43.0	33.0



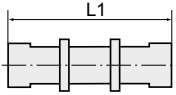

Hose connectors

polypropylene (PP)



140.01-PP

Hose connector

Art. No.	Type No.	For hose mm	L1 mm	a/f mm
110880	140.01-PP	4/6	39.0	14
110881	140.02-PP	6/8	49.0	19
110882	140.03-PP	8/10	55.0	22
110883	140.04-PP	9/12	64.0	24

Elbow hose connectors

polypropylene (PP)



140.11-PP

Elbow hose connector

Art. No.	Type No.	For hose mm	L1 mm	L2 mm
110884	140.11-PP	4/6	25.0	25.0
110885	140.12-PP	6/8	30.0	30.0
110886	140.13-PP	8/10	36.0	36.0
110887	140.14-PP	9/12	43.0	43.0

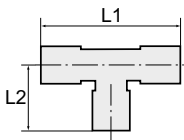

Tee hose connectors

polypropylene (PP)



140.21-PP

Tee hose connector

Art. No.	Type No.	For hose mm	L1 mm	L2 mm
110888	140.21-PP	4/6	52.0	26.0
110889	140.22-PP	6/8	62.0	31.0
110890	140.23-PP	8/10	72.0	36.0
110891	140.24-PP	9/12	80.0	40.0

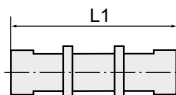

Bulkhead couplings

polypropylene (PP)



140.31-PP

Bulkhead coupling

Art. No.	Type No.	Thread	For hose mm	L1 mm	a/f mm
110892	140.31-PP	M10x1.0	4/6	53.0	14
110893	140.32-PP	M14x1.5	6/8	64.0	19
110894	140.33-PP	M16x1.5	8/10	73.0	22
110895	140.34-PP	M18x1.5	9/12	84.0	24

Bulkhead elbow couplings

polypropylene (PP)

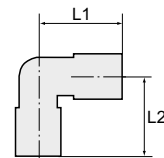

140.41-PP

Bulkhead elbow coupling

Art. No.	Type No.	Thread	For hose mm	L1 mm	L2 mm	a/f mm
110896	140.41-PP	M10x1.0	4/6	43.0	25.0	14
110897	140.42-PP	M14x1.5	6/8	53.0	33.0	19
110898	140.43-PP	M16x1.5	8/10	58.0	36.0	22
110899	140.44-PP	M18x1.5	9/12	67.0	43.0	24

→ Polypropylen knurled nuts and clamping rings please see at page 683

Tube fittings

perfluoroalkoxy alkane (PFA), for use with PTFE hoses

Perfluoroalkoxy alkane (PFA): A fluoroplastic with the same chemical resistance as PTFE but much stronger and suitable for temperatures up to 200°C.

Material	Perfluoroalkoxy alkane (PFA)
Max. Operating pressure at 20 °C	10 bar
Max. Operating pressure from 170 °C	1 bar
Max. operating temperature	200 °C

Unions

perfluoroalkoxy alkane (PFA), for use with PTFE hoses

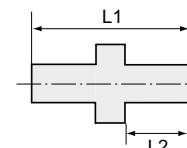

120.11.603

Male connector with male G thread

Art. No.	Type No.	Thread	For hose mm	L1 mm	L2 mm	a/f mm
110900	120.01.603	G 1/8	4/6	31.5	8.0	14
110901	120.02.603	G 1/8	6/8	36.5	8.0	17
110902	120.03.603	G 1/8	8/10	40.5	8.0	19
110903	120.11.603	G 1/4	4/6	37.0	12.0	17
110904	120.12.603	G 1/4	6/8	41.0	12.0	17
110905	120.13.603	G 1/4	8/10	45.0	12.0	19
110906	120.14.603	G 1/4	9/12	48.5	12.0	22
110907	120.21.603	G 3/8	4/6	38.5	12.0	22
110908	120.22.603	G 3/8	6/8	42.5	12.0	22
110909	120.23.603	G 3/8	8/10	45.5	12.0	22
110910	120.24.603	G 3/8	9/12	49.5	12.0	22
110911	120.31.603	G 1/2	4/6	43.0	14.0	27
110912	120.32.603	G 1/2	6/8	47.0	14.0	27
110913	120.33.603	G 1/2	8/10	50.0	14.0	27
110914	120.34.603	G 1/2	9/12	54.0	14.0	27



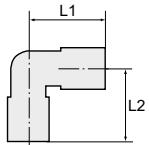

Union elbows

perfluoroalkoxy alkane (PFA), for use with PTFE hoses



140.51.603

Male elbow with male G thread

Art. No.	Type No.	Thread	For hose mm	L1 mm	L2 mm
110915	140.51.603	G 1/8	4/6	25.0	20.0
110916	140.52.603	G 1/8	6/8	30.0	23.0
110917	140.53.603	G 1/8	8/10	36.0	25.0
110918	140.61.603	G 1/4	4/6	26.0	25.0
110919	140.62.603	G 1/4	6/8	30.0	27.0
110920	140.63.603	G 1/4	8/10	36.0	32.0
110921	140.71.603	G 3/8	4/6	29.0	30.0
110922	140.72.603	G 3/8	6/8	33.0	27.0
110923	140.73.603	G 3/8	8/10	36.0	29.0
110924	140.81.603	G 1/2	4/6	32.0	29.0
110925	140.82.603	G 1/2	6/8	36.0	29.0
110926	140.83.603	G 1/2	8/10	39.0	31.0

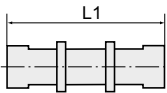

Hose connectors

perfluoroalkoxy alkane (PFA), for use with PTFE hoses



140.01.603

Hose connector

Art. No.	Type No.	For hose mm	L1 mm	a/f mm
110927	140.01.603	4/6	39.0	14
110928	140.02.603	6/8	49.0	19
110929	140.03.603	8/10	55.0	22
110930	140.04.603	9/12	64.0	24

Elbow hose connectors

perfluoroalkoxy alkane (PFA), for use with PTFE hoses

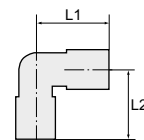

Elbow hose connector				
Art. No.	Type No.	For hose mm	L1 mm	L2 mm
110931	140.11.603	4/6	25.0	25.0
110932	140.12.603	6/8	30.0	30.0
110933	140.13.603	8/10	36.0	36.0



140.13.603

Tee hose connectors

perfluoroalkoxy alkane (PFA), for use with PTFE hoses

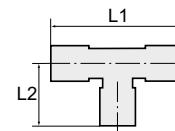

Tee hose connector				
Art. No.	Type No.	For hose mm	L1 mm	L2 mm
110934	140.21.603	4/6	52.0	26.0
110935	140.22.603	6/8	62.0	31.0
110936	140.23.603	8/10	72.0	36.0



140.21.603

Knurled nuts

perfluoroalkoxy alkane (PFA), for use with PTFE hoses



Knurled nut				
Art. No.	Type No.	Thread	For hose mm	L1 mm
110937	160.01.603	M10x1.0	4/6	13.5
110938	160.02.603	M14x1.5	6/8	17.0
110939	160.03.603	M16x1.5	8/10	18.0
110940	160.04.603	M18x1.5	9/12	20.0



160.01.603

Bite-type tube fittings / seals

PEEK (bite-type tube fittings) / PTFE (seals)



Bite-type tube fitting (PEEK) / seals (PTFE)		
Art. No.	Type No.	For hose mm
110941	170.01.603	4/6
110942	170.02.603	6/8
110943	170.03.603	8/10
110944	170.04.603	9/12



170.01.603



Tube connectors

brass and acetal copolymer (POM)

Tube connectors for polyamide hoses and polyurethane hoses made of brass CW617N and acetal copolymer (POM).

Temperature range	-10 to 60 °C
Max. working pressure	10 bar
Max. allowable pressure	10 bar

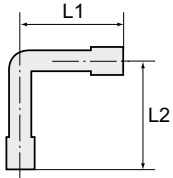

Elbow hose connectors

brass and acetal copolymer (POM)

EASY



LPK-600

Elbow hose connectors, brass and POM

Art. No.	Type No.	For hose mm	L1 mm	L2 mm
133407	LPK-300	I.D. 3	15.3	15.3
133408	LPK-400	I.D. 4	18.7	18.7
133409	LPK-600	I.D. 6	25.8	25.8

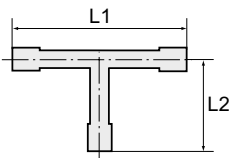

Tee hose connectors

brass and acetal copolymer (POM)

EASY



TPK-600

Tee hose connectors, brass and POM

Art. No.	Type No.	For hose mm	L1 mm	L2 mm
133410	TPK-300	I.D. 3	30.6	15.3
133411	TPK-400	I.D. 4	37.3	18.7
133412	TPK-600	I.D. 6	51.6	25.8

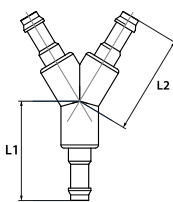

Y-hose connectors

brass and acetal copolymer (POM)

EASY



YPK-600

Y-hose connectors, brass and POM

Art. No.	Type No.	For hose mm	L1 mm	L2 mm
133413	YPK-300	I.D. 3	15.9	15.9
133414	YPK-400	I.D. 4	20.2	20.2
133415	YPK-600	I.D. 6	24.0	29.0

V-hose connectors

brass and acetal copolymer (POM)

EASY

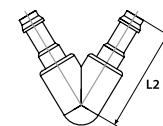

VPK-600

V-hose connectors, brass and POM				
Art. No.	Type No.	For hose mm	L2 mm	
133416	VPK-300	I.D. 3	15.9	
133417	VPK-400	I.D. 4	20.2	
133418	VPK-600	I.D. 6	30.0	

Tube connectors

brass and nickel-plated brass

Tube connectors for polyamide hoses and polyurethane hoses made of brass CW617N.

Temperature range	-10 to 60 °C
Max. working pressure	10 bar
Max. allowable pressure	10 bar

Hose connectors

brass

EASY

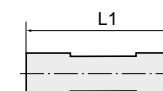

RTU-6-6

Hose connector, brass				
Art. No.	Type No.	For hose mm	L1 mm	
133400	RTU-2-2	I.D. 2	14.0	
133401	RTU-3-3	I.D. 3	19.0	
133402	RTU-4-4	I.D. 4	23.0	
133403	RTU-6-6	I.D. 6	28.0	

Hose connector, unequal, brass				
Art. No.	Type No.	For hose mm	L1 mm	
133404	RTU-3-2	I.D. 3/2	18.0	
133405	RTU-4-3	I.D. 4/3	20.0	
133406	RTU-6-4	I.D. 6/4	25.5	



RTU-6-4

Double hose fittings

brass CW614N

EASY



Double hose fitting, brass				
Art. No.	Type No.	Max. working pressure bar	For hose mm	L1 mm
136262	MS1700404	16	I.D. 4	45.0
136263	MS1700505	16	I.D. 5	49.0
136264	MS1700606	16	I.D. 6	55.0
136265	MS1700808	16	I.D. 8	55.0
136266	MS1700909	16	I.D. 9	55.0
136267	MS1701010	16	I.D. 10	55.0
136268	MS1701212	16	I.D. 12	55.0



MS1700909

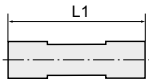

Double hose fittings

brass CW614N

EASY

Double hose fitting, brass

Art. No.	Type No.	Max. working pressure bar	For hose mm	L1 mm
136269	MS1701313	16	I.D. 13	55.0
136270	MS1701414	16	I.D. 14	55.0
136271	MS1701616	16	I.D. 16	71.0
136272	MS1701919	16	I.D. 19	71.0
136273	MS1702525	16	I.D. 25	77.0



MS1700913

Double hose fitting, nickel-plated brass, reduced

Art. No.	Type No.	Max. working pressure bar	For hose mm	L1 mm
136274	MS1700609	16	I.D. 6, 9	55.0
136275	MS1700913	16	I.D. 9, 13	55.0

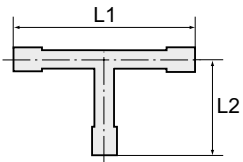

Tee hose connectors

brass CW617N

EASY



171 B

Tee hose connectors, brass

Art. No.	Type No.	Max. working pressure bar	For hose mm	L1 mm	L2 mm
134502	171 A	10	I.D. 5	38.0	19.0
134503	171 B	10	I.D. 6	38.0	19.0
134504	171 C	10	I.D. 8	54.0	27.0
134505	171 D	10	I.D. 9	54.0	27.0
134506	171 E	10	I.D. 13	70.0	35.0

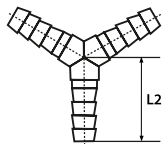

Y-hose connectors

brass CW617N

EASY



172 B

Y-hose connectors, brass

Art. No.	Type No.	Max. working pressure bar	For hose mm	L2 mm
140113	172 A/0	10	I.D. 4	19.0
134507	172 A	10	I.D. 5	19.0
134508	172 B	10	I.D. 6	19.0
134509	172 C	10	I.D. 8	27.0
134510	172 D	10	I.D. 9	27.0
134511	172 E	10	I.D. 13	35.0

Cross push-on connectors

brass CW617N

EASY

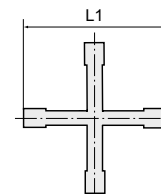

173 B

Cross push-on connectors, brass

Art. No.	Type No.	Max. working pressure bar	For hose mm	L1 mm
140115	173 A/0	10	I.D. 4	38.0
134512	173 A	10	I.D. 5	38.0
134513	173 B	10	I.D. 6	38.0
134514	173 C	10	I.D. 8	46.0
134515	173 D	10	I.D. 9	54.0
134516	173 E	10	I.D. 13	70.0

Double hose fittings

nickel-plated brass CW614N

EASY

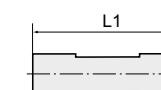

MSN1700909

Double hose fitting, nickel-plated brass

Art. No.	Type No.	Max. working pressure bar	For hose mm	L1 mm
136542	MSN1700404	16	I.D. 4	45.0
136543	MSN1700505	16	I.D. 5	49.0
136544	MSN1700606	16	I.D. 6	55.0
136545	MSN1700808	16	I.D. 8	55.0
136546	MSN1700909	16	I.D. 9	55.0
136547	MSN1701010	16	I.D. 10	55.0
136548	MSN1701212	16	I.D. 12	55.0
136549	MSN1701313	16	I.D. 13	55.0
136550	MSN1701414	16	I.D. 14	55.0
136551	MSN1701616	16	I.D. 16	71.0
136552	MSN1701919	16	I.D. 19	71.0
136553	MSN1702525	16	I.D. 25	77.0

Double hose fitting, reduced, nickel-plated brass

Art. No.	Type No.	Max. working pressure bar	For hose mm	L1 mm
136554	MSN1700609	16	I.D. 6, 9	55.0
136555	MSN1700913	16	I.D. 9, 13	55.0



MSN1700913



Tube connectors

polyamide (PA 6)

Lightweight tube connectors distinguished by high strength, toughness, resistance to abrasion and impact resistance.

Temperature range	-40 to 90 °C
Max. allowable pressure	10 bar

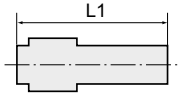

Male stud couplings

polyamide (PA 6)



31.132

Male stud coupling, polyamide, conical male thread acc. to ISO 7-1

Art. No.	Type No.	Thread	For hose mm	L1 mm	a/f mm
110945	31.120	M5	I.D. 3	19.5	6
110946	31.121	R 1/8	I.D. 4	27.0	10
110947	31.122	R 1/8	I.D. 6	32.5	10
110948	31.123	R 1/8	I.D. 8	38.0	14
110949	31.131	R 1/4	I.D. 4	32.0	14
110950	31.131/5	R 1/4	I.D. 5	36.0	14
110951	31.132	R 1/4	I.D. 6	37.5	14
110952	31.133	R 1/4	I.D. 8	41.0	14
110953	31.134	R 1/4	I.D. 10	43.5	14
110954	31.141	R 3/8	I.D. 6	39.0	17
110955	31.142	R 3/8	I.D. 8	41.0	17
110956	31.143	R 3/8	I.D. 10	43.5	17
110957	31.144	R 3/8	I.D. 12	45.5	17
110958	31.151	R 1/2	I.D. 8	49.0	22
110959	31.152	R 1/2	I.D. 12	54.0	22
110960	31.153	R 1/2	I.D. 16	58.0	22
110961	31.161	R 3/4	I.D. 16	58.0	27
110962	31.162	R 3/4	I.D. 19	58.0	27
110963	31.171	R 1	I.D. 25	69.0	32

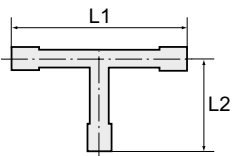

Male stud tees

polyamide (PA 6)



32.242

Male stud tee, polyamide, conical male thread acc. to ISO 7-1

Art. No.	Type No.	Thread	For hose mm	L1 mm	L2 mm	a/f mm
110964	32.231	R 1/8	I.D. 4	42.0	18.0	10
110965	32.232	R 1/8	I.D. 6	57.0	21.0	10
110966	32.241	R 1/4	I.D. 4	42.0	23.0	14
110967	32.242	R 1/4	I.D. 6	57.0	26.0	14
110968	32.243	R 1/4	I.D. 8	66.0	27.5	14
110969	32.251	R 3/8	I.D. 10	71.0	30.0	17

Male stud elbows

polyamide (PA 6)

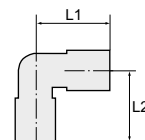

32.342

Male stud elbow, polyamide, conical male thread acc. to ISO 7-1

Art. No.	Type No.	Thread	For hose mm	L1 mm	L2 mm	a/f mm
110970	32.331	R 1/8	I.D. 4	16.0	21.0	10
110971	32.332	R 1/8	I.D. 6	21.0	28.5	10
110972	32.333	R 1/8	I.D. 8	23.0	33.0	14
110973	32.341	R 1/4	I.D. 4	25.0	21.0	14
110974	32.342	R 1/4	I.D. 6	26.0	28.5	14
110975	32.343	R 1/4	I.D. 8	27.5	33.0	14
110976	32.344	R 1/4	I.D. 10	30.0	38.0	14
110977	32.351	R 3/8	I.D. 6	27.0	28.5	17
110978	32.352	R 3/8	I.D. 8	31.0	36.0	17
110979	32.353	R 3/8	I.D. 10	30.0	38.0	17
110980	32.354	R 3/8	I.D. 12	31.0	40.5	17
110981	32.361	R 1/2	I.D. 8	36.0	36.0	22
110982	32.362	R 1/2	I.D. 12	36.0	40.5	22
110983	32.371	R 3/4	I.D. 19	42.8	45.5	27

Blanking plugs

polyamide (PA 6)



Blanking plug, polyamide, conical male thread acc. to ISO 7-1

Art. No.	Type No.	Thread	L1 mm	a/f mm
110984	33.900	R 1/8	26.0	10
110985	33.901	R 1/4	12.5	14
110986	33.902	R 3/8	17.5	17
110987	33.903	R 1/2	27.0	22



33.901



Tube connectors

acetal copolymer (POM)

Lightweight tube connectors distinguished by high strength, toughness, resistance to abrasion and impact resistance.

Temperature range	-40 to 80 °C
Max. allowable pressure	10 bar

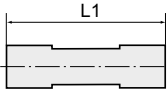

Hose connectors

acetal copolymer (POM)



34.413

Hose connector, POM

Art. No.	Type No.	For hose mm	L1 mm
110988	34.410	I.D. 3	25.0
110989	34.411	I.D. 4	35.0
110990	34.411/5	I.D. 5	45.0
110991	34.412	I.D. 6	49.0
110992	34.413	I.D. 8	56.0
110993	34.414	I.D. 10	63.0
110994	34.415	I.D. 12	66.5
110995	34.416	I.D. 13	73.0
110996	34.417	I.D. 16	75.0
110997	34.418	I.D. 19	76.0
110998	34.419	I.D. 25	95.0



34.424

Hose connector, unequal, POM

Art. No.	Type No.	For hose mm	L1 mm
110999	34.420	I.D. 4 - 3	30.0
111000	34.421	I.D. 6 - 4	42.5
111001	34.422	I.D. 8 - 4	48.0
111002	34.423	I.D. 8 - 6	54.0
111003	34.424	I.D. 10 - 6	58.0
111004	34.425	I.D. 10 - 8	60.5
111005	34.426	I.D. 12 - 8	62.5
111006	34.427	I.D. 12 - 10	64.0

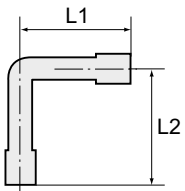

Elbow hose connectors

acetal copolymer (POM)



34.813

Hose union elbow, POM

Art. No.	Type No.	For hose mm	L1 mm	L2 mm
111007	34.809	I.D. 3	12.5	12.5
111008	34.811	I.D. 4	17.5	19.5
111009	34.811/5	I.D. 5	21.0	22.0
111010	34.812	I.D. 6	25.0	26.0
111011	34.813	I.D. 8	29.0	30.0

Elbow hose connectors

acetal copolymer (POM)

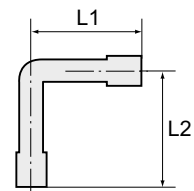

Hose union elbow, POM

Art. No.	Type No.	For hose mm	L1 mm	L2 mm
111012	34.814	I.D. 10	31.0	33.5
111013	34.815	I.D. 12	34.5	36.0
111014	34.816	I.D. 13	36.5	38.5
111015	34.817	I.D. 16	40.5	45.0
111016	34.818	I.D. 19	43.5	46.0
111017	34.819	I.D. 25	52.5	52.5

Tee hose connectors

acetal copolymer (POM)

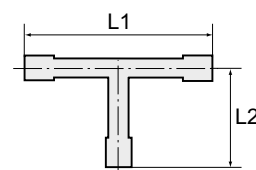

Tee hose connector, POM

Art. No.	Type No.	For hose mm	L1 mm	L2 mm
111018	35.510	I.D. 3	25.0	12.5
111019	35.511	I.D. 4	35.0	19.5
111020	35.511/5	I.D. 5	42.0	22.0
111021	35.512	I.D. 6	50.0	26.0
111022	35.513	I.D. 8	58.0	30.0
111023	35.514	I.D. 10	62.5	33.5
111024	35.515	I.D. 12	69.0	36.0
111025	35.516	I.D. 13	68.0	36.0
111026	35.517	I.D. 16	81.0	45.0
111027	35.518	I.D. 19	85.0	45.0
111028	35.519	I.D. 25	105.0	52.5



35.513

Reducing T push-on connector, POM

Art. No.	Type No.	For hose mm	L1 mm	L2 mm
111029	35.520	I.D. 3/4/3	25.0	17.5
111030	35.521	I.D. 4/6/4	37.0	24.0
111031	35.522	I.D. 6/4/6	49.0	20.5
111032	35.523	I.D. 8/4/8	56.0	22.0
111033	35.524	I.D. 8/6/8	56.0	28.0
111034	35.525	I.D. 10/6/10	62.0	28.0
111035	35.526	I.D. 10/8/10	62.0	31.0
111036	35.527	I.D. 12/6/12	69.0	29.0
111037	35.528	I.D. 12/8/12	69.0	31.0
111038	35.529	I.D. 12/10/12	69.0	33.0
111039	35.530	I.D. 18/10/18	79.0	36.0
111040	35.531	I.D. 18/15/18	80.0	44.0



35.524



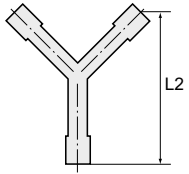

Y-hose connectors

acetal copolymer (POM)



36.613



36.713

Y-hose connector, 90° angle, POM

Art. No.	Type No.	For hose mm	L2 mm
111041	36.610	I.D. 3	21.0
111042	36.611	I.D. 4	25.5
111043	36.611/5	I.D. 5	43.0
111044	36.612	I.D. 6	44.0
111045	36.613	I.D. 8	51.0
111046	36.614	I.D. 10	54.0
111047	36.615	I.D. 12	64.0
111048	36.616	I.D. 13	65.0
111049	36.617	I.D. 16	67.0
111050	36.618	I.D. 19	72.0

Reducing Y push-on connector, POM

Art. No.	Type No.	For hose mm	L2 mm
111051	36.711	I.D. 4/6/4	35.0
111052	36.713	I.D. 6/8/6	49.0

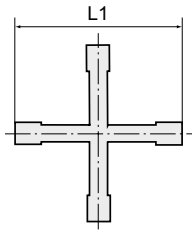

Cross push-on connectors

acetal copolymer (POM)



37.112

Cross push-on connector, POM

Art. No.	Type No.	For hose mm	L1 mm
111053	37.111	I.D. 4	39.0
111054	37.112	I.D. 6	48.0
111055	37.115	I.D. 12	69.0

Double pipe nipples

EASY

Material	Brass with a bare metal surface
Max. working pressure	10 bar
Max. medium temperature	90 °C
Max. ambient temperature	90 °C

Double pipe nipple, brass

Art. No.	Type No.	Thread	Length mm
111056	LN 1230	G 1/2	30.0
111057	LN 1240	G 1/2	40.0
111058	LN 1250	G 1/2	50.0
111059	LN 1260	G 1/2	60.0
111060	LN 1280	G 1/2	80.0
111061	LN 12100	G 1/2	100.0
111062	LN 12120	G 1/2	120.0
111063	LN 12150	G 1/2	150.0
111064	LN 12180	G 1/2	180.0
111065	LN 12200	G 1/2	200.0
111066	LN 3440	G 3/4	40.0
111067	LN 3460	G 3/4	60.0
111068	LN 3480	G 3/4	80.0
111069	LN 34100	G 3/4	100.0
111070	LN 34120	G 3/4	120.0
111071	LN 34150	G 3/4	150.0
111072	LN 34180	G 3/4	180.0
111073	LN 34200	G 3/4	200.0
111074	LN 10040	G 1	40.0
111075	LN 10060	G 1	60.0
111076	LN 10080	G 1	80.0
111077	LN 100100	G 1	100.0
111078	LN 100120	G 1	120.0
111079	LN 100150	G 1	150.0
111080	LN 100180	G 1	180.0
111081	LN 100200	G 1	200.0
111082	LN 11460	G 1 1/4	60.0
111083	LN 11480	G 1 1/4	80.0
111084	LN 114100	G 1 1/4	100.0
111085	LN 114120	G 1 1/4	120.0
111086	LN 114150	G 1 1/4	150.0
111087	LN 114180	G 1 1/4	180.0
111088	LN 114200	G 1 1/4	200.0
111089	LN 11260	G 1 1/2	60.0
111090	LN 11280	G 1 1/2	80.0
111091	LN 112100	G 1 1/2	100.0
111092	LN 112120	G 1 1/2	120.0
111093	LN 112150	G 1 1/2	150.0
111094	LN 112200	G 1 1/2	200.0
111095	LN 20060	G 2	60.0
111096	LN 20080	G 2	80.0
111097	LN 200100	G 2	100.0
111098	LN 200120	G 2	120.0
111099	LN 200150	G 2	150.0
111100	LN 200200	G 2	200.0



LN 1280



Standard screw fittings

brass

Max. working pressure	25 bar
Max. operating temperature	150 °C
Material	Brass CW614N

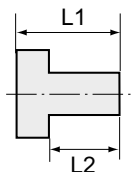

Reducing nipples

brass

PLUS



MS251K1418

Reducing nipple, short type, parallel version

Art. No.	Type No.	Male thread	Female thread	L1 mm	L2 mm	a/f mm
134441	MS251K1418	G 1/4	G 1/8	14.0	9.0	17
134442	MS251K3818	G 3/8	G 1/8	14.0	9.0	19
134443	MS251K3814	G 3/8	G 1/4	14.0	9.0	19
134444	MS251K1218	G 1/2	G 1/8	17.0	11.0	24
134445	MS251K1214	G 1/2	G 1/4	17.0	11.0	24
134446	MS251K1238	G 1/2	G 3/8	17.0	11.0	24
134447	MS251K3414	G 3/4	G 1/4	18.0	12.0	32
134448	MS251K3438	G 3/4	G 3/8	18.0	12.0	32
134449	MS251K3412	G 3/4	G 1/2	18.0	12.0	32
134450	MS251K112	G 1	G 1/2	19.0	13.0	38
134451	MS251K134	G 1	G 3/4	19.0	13.0	38
134452	MS251K11434	G 1 1/4	G 3/4	21.0	14.0	50
134453	MS251K1141	G 1 1/4	G 1	21.0	14.0	50
134455	MS251K11234	G 1 1/2	G 3/4	23.0	15.0	55
134456	MS251K1121	G 1 1/2	G 1	23.0	15.0	55
134457	MS251K112114	G 1 1/2	G 1 1/4	23.0	15.0	55
134458	MS251K21	G 2	G 1	28.0	20.0	70
134459	MS251K2114	G 2	G 1 1/4	28.0	20.0	70
134460	MS251K2112	G 2	G 1 1/2	28.0	20.0	70
134461	MS251K212112	G 2 1/2	G 1 1/2	32.0	23.0	80
134462	MS251K2122	G 2 1/2	G 2	32.0	23.0	80
134463	MS251K31	G 3	G 1	36.0	26.0	95
134464	MS251K3114	G 3	G 1 1/4	36.0	26.0	95
134465	MS251K3112	G 3	G 1 1/2	36.0	26.0	95
134466	MS251K32	G 3	G 2	36.0	26.0	95
134467	MS251K3212	G 3	G 2 1/2	36.0	26.0	95



MS251K14M5

Reducing nipple, short type

Art. No.	Type No.	Male thread	Female thread	L1 mm	L2 mm	a/f mm
134468	MS251KM53	M5	M3	8.0	5.0	7
134469	MS251KM1410	M14x1.5	M10x1.0	14.0	9.0	17
134470	MS251KM2416	M24x1.5	M16x1.5	24.0	16.0	28
134471	MS251K18M5	G 1/8	M5	11.0	7.0	14
134472	MS251K14M5	G 1/4	M5	14.0	9.0	17

Reducing nipples

brass

PLUS

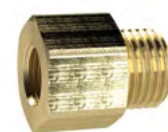
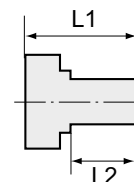

MS251L1418

Reducing nipple, long type, parallel						
Art. No.	Type No.	Male thread	Female thread	L1 mm	L2 mm	a/f mm
134680	MS251L1818	G 1/8	G 1/8	19.0	7.0	14
134681	MS251L1814	G 1/8	G 1/4	23.0	7.0	17
134682	MS251L1418	G 1/4	G 1/8	22.0	9.0	17
134683	MS251L1414	G 1/4	G 1/4	24.0	9.0	17
134684	MS251L1438	G 1/4	G 3/8	27.0	9.0	19
134685	MS251L3814	G 3/8	G 1/4	23.0	9.0	19
134686	MS251L3838	G 3/8	G 3/8	24.0	9.0	19
134687	MS251L3812	G 3/8	G 1/2	29.0	9.0	24
134688	MS251L1238	G 1/2	G 3/8	26.0	11.0	24
134689	MS251L1212	G 1/2	G 1/2	29.0	11.0	24
134690	MS251L1234	G 1/2	G 3/4	32.0	11.0	32
134691	MS251L3412	G 3/4	G 1/2	29.0	12.0	32
134692	MS251L3434	G 3/4	G 3/4	34.0	12.0	32
134693	MS251L341	G 3/4	G 1	34.0	12.0	36
134694	MS251L134	G 1	G 3/4	35.0	13.0	38
134695	MS251L11	G 1	G 1	33.0	13.0	38
134696	MS251L1114	G 1	G 1 1/4	37.0	13.0	50
134697	MS251L1141	G 1 1/4	G 1	36.0	14.0	50
134698	MS251L114114	G 1 1/4	G 1 1/4	36.0	14.0	50
134699	MS251L114112	G 1 1/4	G 1 1/2	38.0	14.0	55
134700	MS251L112114	G 1 1/2	G 1 1/4	35.0	15.0	55
134701	MS251L112112	G 1 1/2	G 1 1/2	37.0	15.0	55
134702	MS251L1122	G 1 1/2	G 2	46.0	15.0	70
134703	MS251L2114	G 2	G 1 1/4	48.0	20.0	70
134704	MS251L2112	G 2	G 1 1/2	48.0	20.0	70

Reducing nipple, long type						
Art. No.	Type No.	Male thread	Female thread	L1 mm	L2 mm	a/f mm
134705	MS251LM35	M3	M5	11.0	3.0	7
134706	MS251LM53	M5	M3	13.0	5.0	7
134707	MS251LM55	M5	M5	13.0	5.0	7
134708	MS251LM518	M5	G 1/8	19.0	5.0	14
134709	MS251L18M5	G 1/8	M5	17.0	7.0	14



MS251L18M5

Screw plugs

brass

PLUS

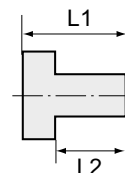

Hexagon socket screw plug with collar					
Art. No.	Type No.	Thread	L1 mm	L2 mm	a/f mm
135962	MS290MS18	G 1/8 hexagon socket head	10.0	7.0	5
135963	MS290MS14	G 1/4 hexagon socket head	12.0	9.0	6
135965	MS290MS38	G 3/8 hexagon socket head	12.0	9.0	8
135966	MS290MS12	G 1/2 hexagon socket head	15.0	11.0	10
135967	MS290MS34	G 3/4 hexagon socket head	16.0	12.0	12
135968	MS290MS1	G 1 hexagon socket head	18.0	13.0	17
135969	MS290MS114	G 1 1/4 hexagon socket head	19.0	14.0	22
135970	MS290MS112	G 1 1/2 hexagon socket head	20.0	15.0	24
135971	MS290MS2	G 2 hexagon socket head	25.0	20.0	27



MS290MS14

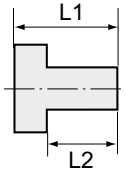

Screw plugs

brass

PLUS



MS290OB14

Hexagon socket screw plug without collar

Art. No.	Type No.	Thread	L1 mm	a/f mm
135976	MS290OBM8	M8x0.75 hexagon socket head	8.0	4
135977	MS290OBM10	M10x1.0 hexagon socket head	8.0	5
135988	MS290OBM12	M12x1.5 hexagon socket head	8.0	6
135989	MS290OBM14	M14x1.5 hexagon socket head	10.0	7
135990	MS290OB18	G 1/8 hexagon socket head	8.0	5
135991	MS290OB14	G 1/4 hexagon socket head	10.0	7
135992	MS290OB38	G 3/8 hexagon socket head	12.0	8
135993	MS290OB12	G 1/2 hexagon socket head	14.0	10
135994	MS290OB34	G 3/4 hexagon socket head	16.0	12
135995	MS290OB1	G 1 hexagon socket head	18.0	17
135996	MS290OB114	G 1 1/4 hexagon socket head	20.0	22
135997	MS290OB112	G 1 1/2 hexagon socket head	22.0	24
135998	MS290OB2	G 2 hexagon socket head	24.0	32



MS290ROB14

Hexagon socket screw plug without collar

Art. No.	Type No.	Thread	L1 mm	a/f mm
136004	MS290ROB18	R 1/8 hexagon socket head	8.0	5
136031	MS290ROB14	R 1/4 hexagon socket head	10.0	7
136078	MS290ROB38	R 3/8 hexagon socket head	10.0	8
136079	MS290ROB12	R 1/2 hexagon socket head	10.0	10
136080	MS290ROB34	R 3/4 hexagon socket head	12.0	12
136081	MS290ROB01	R 1 hexagon socket head	12.0	17
136082	MS290ROB114	R 1 1/4 hexagon socket head	18.0	22
136083	MS290ROB112	R 1 1/2 hexagon socket head	20.0	24
136084	MS290ROB2	R 2 hexagon socket head	22.0	32



MS290SK14

Hexagon head screw plug

Art. No.	Type No.	Thread	L1 mm	L2 mm	a/f mm
136085	MS290SKM5	M5 hexagon head	8.0	4.0	8
136086	MS290SK18	G 1/8 hexagon head	11.0	7.0	14
136087	MS290SK14	G 1/4 hexagon head	15.0	9.0	17
136088	MS290SK38	G 3/8 hexagon head	15.0	9.0	19
136089	MS290SK12	G 1/2 hexagon head	17.0	11.0	24
136090	MS290SK34	G 3/4 hexagon head	20.0	12.0	32
136091	MS290SK1	G 1 hexagon head	21.0	13.0	36
136092	MS290SK114	G 1 1/4 hexagon head	22.0	14.0	50
136093	MS290SK112	G 1 1/2 hexagon head	23.0	15.0	55
136094	MS290SK2	G 2 hexagon head	28.0	20.0	70



MS290SKMB14

Hexagon head screw plug with collar

Art. No.	Type No.	Thread	L1 mm	L2 mm	a/f mm
136095	MS290SKMB18	G 1/8 hexagon head	16.0	9.0	10
136096	MS290SKMB14	G 1/4 hexagon head	18.0	9.0	13
136097	MS290SKMB38	G 3/8 hexagon head	18.0	9.0	17
136098	MS290SKMB12	G 1/2 hexagon head	23.0	11.0	19
136099	MS290SKMB34	G 3/4 hexagon head	26.0	12.0	24
136100	MS290SKMB1	G 1 hexagon head	29.0	13.0	27
136101	MS290SKMB114	G 1 1/4 hexagon head	31.0	14.0	30
136102	MS290SKMB112	G 1 1/2 hexagon head	32.0	15.0	30
136103	MS290SKMB2	G 2 hexagon head	40.0	20.0	36

Double nipples

brass

PLUS

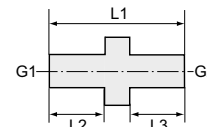

MS2521414

Double nipple, parallel male thread							
Art. No.	Type No.	Thread 1	Thread 2	L1 mm	L2 mm	L3 mm	a/f mm
131744	MS2521818	G 1/8	G 1/8	18.0	7.0	7.0	14
131752	MS2521814	G 1/8	G 1/4	21.0	7.0	9.0	17
131755	MS2521838	G 1/8	G 3/8	21.0	7.0	9.0	19
131756	MS2521414	G 1/4	G 1/4	23.0	9.0	9.0	17
131759	MS2521438	G 1/4	G 3/8	23.0	9.0	9.0	19
131764	MS2521412	G 1/4	G 1/2	26.0	9.0	11.0	24
131765	MS2523838	G 3/8	G 3/8	23.0	9.0	9.0	19
131791	MS2523812	G 3/8	G 1/2	26.0	9.0	11.0	24
131792	MS2523834	G 3/8	G 3/4	27.0	9.0	12.0	32
134118	MS252381	G 3/8	G 1	28.0	9.0	13.0	38
131770	MS2521212	G 1/2	G 1/2	28.0	11.0	11.0	24
131771	MS2521234	G 1/2	G 3/4	29.0	11.0	12.0	32
131772	MS252121	G 1/2	G 1	30.0	11.0	13.0	38
131773	MS2523434	G 3/4	G 3/4	30.0	12.0	12.0	32
131774	MS252341	G 3/4	G 1	31.0	12.0	13.0	38
131775	MS25211	G 1	G 1	32.0	13.0	13.0	38
131776	MS2521114	G 1	G 1 1/4	34.0	13.0	14.0	50
131777	MS2521112	G 1	G 1 1/2	36.0	13.0	15.0	55
131778	MS25212	G 1	G 2	41.0	13.0	20.0	70
134272	MS25211412	G 1 1/4	G 1/2	32.0	14.0	11.0	50
134119	MS25211434	G 1 1/4	G 3/4	33.0	14.0	12.0	50
131779	MS252114114	G 1 1/4	G 1 1/4	35.0	14.0	14.0	50
131780	MS252114112	G 1 1/4	G 1 1/2	37.0	14.0	15.0	55
131781	MS2521142	G 1 1/4	G 2	42.0	14.0	20.0	70
134120	MS25211234	G 1 1/2	G 3/4	34.0	15.0	12.0	50
131782	MS252112112	G 1 1/2	G 1 1/2	38.0	15.0	15.0	55
131783	MS2521122	G 1 1/2	G 2	43.0	15.0	20.0	70
131784	MS25222	G 2	G 2	48.0	20.0	20.0	70
131785	MS2522212	G 2	G 2 1/2	53.0	20.0	23.0	80
131786	MS25223	G 2	G 3	57.0	20.0	26.0	95
131787	MS252212212	G 2 1/2	G 2 1/2	56.0	23.0	23.0	80
131788	MS2522123	G 2 1/2	G 3	60.0	23.0	26.0	95
131789	MS25233	G 3	G 3	63.0	26.0	26.0	95

Double nipple, male thread							
Art. No.	Type No.	Thread 1	Thread 2	L1 mm	L2 mm	L3 mm	a/f mm
134473	MS252M33	M3	M3	9.0	3.0	3.0	5
134474	MS252M53	M5	M3	11.0	5.0	3.0	7
134475	MS252M55	M5	M5	13.0	5.0	5.0	7
134476	MS252M1414	M14x1.5	M14x1.5	23.0	9.0	9.0	17
134477	MS252M1616	M16x1.5	M16x1.5	23.0	9.0	9.0	19
134478	MS252M2424	M24x1.5	M24x1.5	40.0	16.0	16.0	28
134479	MS252M518	M5	G 1/8	16.0	5.0	7.0	14
134480	MS252M514	M5	G 1/4	19.0	5.0	9.0	17
134481	MS25214M14	G 1/4	M14x1.5	23.0	9.0	9.0	17
134482	MS25238M16	G 3/8	M16x1.5	23.0	9.0	9.0	19
134483	MS25212M24	G 1/2	M24x1.5	33.0	11.0	16.0	28



MS25214M14



Double nipple, left-hand thread							
Art. No.	Type No.	Thread 1	Thread 2	L1 mm	L2 mm	L3 mm	a/f mm
134484	MS252LH1414	G 1/4 ccw	G 1/4 ccw	23.0	9.0	9.0	17
134485	MS252LH3838	G 3/8 ccw	G 3/8 ccw	23.0	9.0	9.0	19



MS252LH1414

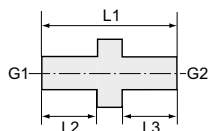

Double nipples

brass

PLUS



MS252R1414

Double nipple, conical male thread

Art. No.	Type No.	Thread 1	Thread 2	L1 mm	L2 mm	L3 mm	a/f mm
134992	MS252R1818	R 1/8	R 1/8	20.0	8.0	8.0	12
134993	MS252R1814	R 1/8	R 1/4	23.0	8.0	11.0	14
134994	MS252R1838	R 1/8	R 3/8	24.0	8.0	11.0	19
134995	MS252R1414	R 1/4	R 1/4	26.0	11.0	11.0	14
134996	MS252R1438	R 1/4	R 3/8	27.0	11.0	11.0	19
134997	MS252R1412	R 1/4	R 1/2	31.0	11.0	14.0	22
134998	MS252R3838	R 3/8	R 3/8	27.0	11.0	11.0	19
134999	MS252R3812	R 3/8	R 1/2	31.0	11.0	14.0	22
135000	MS252R3834	R 3/8	R 3/4	33.0	11.0	16.0	28
135001	MS252R381	R 3/8	R 1	35.0	11.0	18.0	36
135002	MS252R1212	R 1/2	R 1/2	34.0	14.0	14.0	22
135003	MS252R1234	R 1/2	R 3/4	36.0	14.0	16.0	28
135004	MS252R121	R 1/2	R 1	38.0	14.0	18.0	36
135005	MS252R3434	R 3/4	R 3/4	38.0	16.0	16.0	28
135006	MS252R341	R 3/4	R 1	40.0	16.0	18.0	36
135007	MS252R11	R 1	R 1	42.0	18.0	18.0	36
135008	MS252R1114	R 1	R 1 1/4	45.0	18.0	20.0	44
135009	MS252R1112	R 1	R 1 1/2	45.0	18.0	20.0	50
135010	MS252R12	R 1	R 2	51.0	18.0	25.0	62
135011	MS252R11412	R 1 1/4	R 1/2	41.0	20.0	14.0	44
135012	MS252R11434	R 1 1/4	R 3/4	43.0	20.0	16.0	44
135013	MS252R114114	R 1 1/4	R 1 1/4	47.0	20.0	20.0	44
135014	MS252R114112	R 1 1/4	R 1 1/2	47.0	20.0	20.0	50
135015	MS252R1142	R 1 1/4	R 2	53.0	20.0	25.0	62
135016	MS252R11234	R 1 1/2	R 3/4	43.0	20.0	16.0	50
135017	MS252R112112	R 1 1/2	R 1 1/2	47.0	20.0	20.0	50
135018	MS252R1122	R 1 1/2	R 2	53.0	20.0	25.0	62
135019	MS252R22	R 2	R 2	58.0	25.0	25.0	62

Detachable double nipples

brass

PLUS



MS252L1414

Detachable double nipple, male, taper seat

Art. No.	Type No.	Thread 1	Thread 2	L1 mm	a/f mm	a/f 1 mm
136112	MS252L1818	R 1/8	R 1/8	27.0	15	5
136113	MS252L1814	R 1/8	R 1/4	30.0	15	5
136114	MS252L1414	R 1/4	R 1/4	33.0	19	6
136115	MS252L1438	R 1/4	R 3/8	34.0	19	6
136116	MS252L3838	R 3/8	R 3/8	37.0	22	8
136117	MS252L1212	R 1/2	R 1/2	44.5	27	12
136118	MS252L3434	R 3/4	R 3/4	53.0	36	14
136119	MS252L11	R 1	R 1	59.0	50	19
136120	MS252L114114	R 1 1/4	R 1 1/4	68.0	60	22
136121	MS252L112112	R 1 1/2	R 1 1/2	75.0	70	24
136122	MS252L22	R 2	R 2	85.0	80	32

Sockets

brass

PLUS

Socket with outer hex

Art. No.	Type No.	Thread	L1 mm	a/f mm
136123	MS252MUM5	M5	11.0	8
136124	MS252MU18	G 1/8	22.0	14
136125	MS252MU14	G 1/4	26.0	17
136126	MS252MU38	G 3/8	26.0	22
136127	MS252MU12	G 1/2	30.0	27
136128	MS252MU34	G 3/4	36.0	32
136129	MS252MU1	G 1	40.0	41
136130	MS252MU114	G 1 1/4	45.0	50
136131	MS252MU112	G 1 1/2	50.0	55
136132	MS252MU2	G 2	55.0	70



MS252MU14

Socket with outer hex, reduced

Art. No.	Type No.	Thread 1	Thread 2	L1 mm	a/f mm
136133	MS252MU1814	G 1/8	G 1/4	26.0	17
136134	MS252MU1438	G 1/4	G 3/8	26.0	22
136136	MS252MU12M14	G 1/2	M14x1.5	30.0	27
136135	MS252MU3812	G 3/8	G 1/2	30.0	27
136137	MS252MU12M16	G 1/2	M16x1.5	24.0	27
136138	MS252MU34M14	G 3/4	M14x1.5	28.0	32
136139	MS252MU34M16	G 3/4	M16x1.5	28.0	32



MS252MU1438

Male hose fittings

brass

PLUS

Male hose fitting with parallel male thread

Art. No.	Type No.	Thread	For hose mm	L1 mm	L2 mm	a/f mm
130981	MS2391804	G 1/8	I.D. 4	37.0	7.0	14
130984	MS2391806	G 1/8	I.D. 6	37.0	7.0	14
130985	MS2391808	G 1/8	I.D. 8	37.0	7.0	14
130986	MS2391809	G 1/8	I.D. 9	37.0	7.0	14
132482	MS2391810	G 1/8	I.D. 10	39.0	7.0	14
130987	MS2391404	G 1/4	I.D. 4	40.0	9.0	17
130988	MS2391406	G 1/4	I.D. 6	40.0	9.0	17
130989	MS2391408	G 1/4	I.D. 8	40.0	9.0	17
130990	MS2391409	G 1/4	I.D. 9	40.0	9.0	17
130991	MS2391410	G 1/4	I.D. 10	42.0	9.0	17
132483	MS2391412	G 1/4	I.D. 12	42.0	9.0	17
130992	MS2391413	G 1/4	I.D. 13	42.0	9.0	17
130993	MS2393804	G 3/8	I.D. 4	40.0	9.0	19
131024	MS2393806	G 3/8	I.D. 6	40.0	9.0	19
130996	MS2393808	G 3/8	I.D. 8	40.0	9.0	19
130997	MS2393809	G 3/8	I.D. 9	40.0	9.0	19
130998	MS2393810	G 3/8	I.D. 10	42.0	9.0	19
132484	MS2393812	G 3/8	I.D. 12	42.0	9.0	19
130999	MS2393813	G 3/8	I.D. 13	42.0	9.0	19
139749	MS2393814	G 3/8	I.D. 14	42.0	9.0	19
131000	MS2391206	G 1/2	I.D. 6	43.0	11.0	24
131001	MS2391208	G 1/2	I.D. 8	43.0	11.0	24

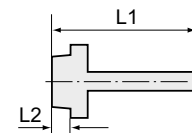

MS2391404



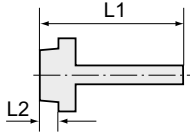

Male hose fittings

brass

PLUS



MS2391404

Male hose fitting with parallel male thread

Art. No.	Type No.	Thread	For hose mm	L1 mm	L2 mm	a/f mm
131002	MS2391209	G 1/2	I.D. 9	43.0	11.0	24
131003	MS2391210	G 1/2	I.D. 10	45.0	11.0	24
132485	MS2391212	G 1/2	I.D. 12	45.0	11.0	24
131004	MS2391213	G 1/2	I.D. 13	45.0	11.0	24
131005	MS2391216	G 1/2	I.D. 16	49.0	11.0	24
131008	MS2391219	G 1/2	I.D. 19	49.0	11.0	24
131009	MS2393409	G 3/4	I.D. 9	44.0	12.0	32
131010	MS2393413	G 3/4	I.D. 13	46.0	12.0	32
131012	MS2393416	G 3/4	I.D. 16	50.0	12.0	32
131013	MS2393419	G 3/4	I.D. 19	50.0	12.0	32
131014	MS2393425	G 3/4	I.D. 25	57.0	12.0	32
131015	MS239119	G 1	I.D. 19	51.0	13.0	38
131016	MS239125	G 1	I.D. 25	58.0	13.0	38
131017	MS239132	G 1	I.D. 32	58.0	13.0	38
131018	MS23911432	G 1 1/4	I.D. 32	60.0	14.0	50
131019	MS23911438	G 1 1/4	I.D. 38	67.0	14.0	50
131020	MS23911232	G 1 1/2	I.D. 32	62.0	15.0	55
131083	MS23911238	G 1 1/2	I.D. 38	69.0	15.0	55
131021	MS23911250	G 1 1/2	I.D. 50	69.0	15.0	55
131023	MS239250	G 2	I.D. 50	74.0	20.0	70
132486	MS23921263	G 2 1/2	I.D. 63	87.0	23.0	80
132487	MS239376	G 3	I.D. 76	91.0	26.0	95



MS239M504

Male hose fitting with metric male thread

Art. No.	Type No.	Thread	For hose mm	L1 mm	L2 mm	a/f mm
132493	MS239M302	M3	I.D. 2	14.0	3.0	5
132496	MS239M303	M3	I.D. 3	14.0	3.0	5
132497	MS239M503	M5	I.D. 3	16.0	5.0	7
132498	MS239M504	M5	I.D. 4	16.0	5.0	7
132500	MS239M506	M5	I.D. 6	16.0	5.0	7
132501	MS239M806	M8x0.75	I.D. 6	22.0	7.0	12
132502	MS239M1009	M10x1	I.D. 9	29.0	9.0	14
132503	MS239M1213	M12x1.5	I.D. 13	42.0	9.0	17
132504	MS239M1413	M14x1.5	I.D. 13	42.0	9.0	17



MS239LH1406

Male hose fitting with left-hand thread

Art. No.	Type No.	Thread	For hose mm	L1 mm	L2 mm	a/f mm
132505	MS239LH1406	G 1/4 left	I.D. 6	40.0	9.0	17
132507	MS239LH3806	G 3/8 left	I.D. 6	40.0	9.0	19
132510	MS239LH3809	G 3/8 left	I.D. 9	40.0	9.0	19

Male hose fitting with conical male thread

Art. No.	Type No.	Thread	For hose mm	L2 mm	a/f mm
117290	MS239R1804	R 1/8	I.D. 4	8.0	14
117291	MS239R1806	R 1/8	I.D. 6	8.0	14
117292	MS239R1808	R 1/8	I.D. 8	8.0	14
117293	MS239R1809	R 1/8	I.D. 9	8.0	14
117295	MS239R1810	R 1/8	I.D. 10	8.0	14
117298	MS239R1404	R 1/4	I.D. 4	11.0	17
117301	MS239R1406	R 1/4	I.D. 6	11.0	17
117335	MS239R1408	R 1/4	I.D. 8	11.0	17
117352	MS239R1409	R 1/4	I.D. 9	11.0	17

Male hose fittings

brass

PLUS

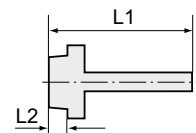

Male hose fitting with conical male thread

Art. No.	Type No.	Thread	For hose mm	L2 mm	a/f mm
117381	MS239R1410	R 1/4	I.D. 10	11.0	17
117439	MS239R1412	R 1/4	I.D. 12	11.0	17
117441	MS239R1413	R 1/4	I.D. 13	11.0	17
117442	MS239R3804	R 3/8	I.D. 4	11.0	19
117443	MS239R3806	R 3/8	I.D. 6	11.0	19
117503	MS239R3808	R 3/8	I.D. 8	11.0	19
117504	MS239R3809	R 3/8	I.D. 9	11.0	19
117505	MS239R3810	R 3/8	I.D. 10	11.0	19
117554	MS239R3812	R 3/8	I.D. 12	11.0	19
117559	MS239R3813	R 3/8	I.D. 13	11.0	19
117562	MS239R1206	R 1/2	I.D. 6	14.0	24
117594	MS239R1208	R 1/2	I.D. 8	14.0	24
117595	MS239R1209	R 1/2	I.D. 9	14.0	24
117754	MS239R1210	R 1/2	I.D. 10	14.0	24
117766	MS239R1212	R 1/2	I.D. 12	14.0	24
117767	MS239R1213	R 1/2	I.D. 13	14.0	24
117768	MS239R1216	R 1/2	I.D. 16	14.0	24
117769	MS239R1219	R 1/2	I.D. 19	14.0	24
117771	MS239R3409	R 3/4	I.D. 9	16.0	32
117772	MS239R3413	R 3/4	I.D. 13	16.0	32
117773	MS239R3416	R 3/4	I.D. 16	16.0	32
117774	MS239R3419	R 3/4	I.D. 19	16.0	32
117775	MS239R3425	R 3/4	I.D. 25	16.0	32
117776	MS239R119	R 1	I.D. 19	18.0	36
117777	MS239R125	R 1	I.D. 25	18.0	36
117778	MS239R132	R 1	I.D. 32	18.0	36
117779	MS239R11432	R 1 1/4	I.D. 32	20.0	44
117780	MS239R11438	R 1 1/4	I.D. 38	20.0	44
117781	MS239R11232	R 1 1/2	I.D. 32	20.0	55
117782	MS239R11238	R 1 1/2	I.D. 38	20.0	55
117783	MS239R11250	R 1 1/2	I.D. 50	20.0	55
117784	MS239R250	R 2	I.D. 50	25.0	70

Female hose fittings

brass

PLUS

Female hose fitting with female thread

Art. No.	Type No.	Thread	For hose mm	L1 mm	L2 mm	a/f mm
134816	MS239A1804	G 1/8	I.D. 4	36.0	10.0	14
134817	MS239A1806	G 1/8	I.D. 6	36.0	10.0	14
134818	MS239A1808	G 1/8	I.D. 8	36.0	10.0	14
134819	MS239A1809	G 1/8	I.D. 9	36.0	10.0	14
134820	MS239A1810	G 1/8	I.D. 10	38.0	10.0	14
134821	MS239A1404	G 1/4	I.D. 4	37.0	11.0	17
134822	MS239A1406	G 1/4	I.D. 6	37.0	11.0	17
134823	MS239A1408	G 1/4	I.D. 8	37.0	11.0	17
134824	MS239A1409	G 1/4	I.D. 9	37.0	11.0	17
134825	MS239A1410	G 1/4	I.D. 10	39.0	11.0	17
134826	MS239A1412	G 1/4	I.D. 12	39.0	11.0	17



MS239A1404



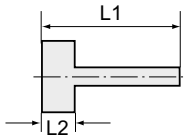

MS239A1404

Female hose fittings

brass

PLUS

Female hose fitting with female thread

Art. No.	Type No.	Thread	For hose mm	L1 mm	L2 mm	a/f mm
134827	MS239A1413	G 1/4	I.D. 13	39.0	11.0	17
134828	MS239A3804	G 3/8	I.D. 4	37.0	11.0	19
134829	MS239A3806	G 3/8	I.D. 6	37.0	11.0	19
134830	MS239A3808	G 3/8	I.D. 8	37.0	11.0	19
134831	MS239A3809	G 3/8	I.D. 9	37.0	11.0	19
134832	MS239A3810	G 3/8	I.D. 10	39.0	11.0	19
134833	MS239A3812	G 3/8	I.D. 12	39.0	11.0	19
134834	MS239A3813	G 3/8	I.D. 13	39.0	11.0	19
139775	MS239A3814	G 3/8	I.D. 14	39.0	11.0	19
134836	MS239A1206	G 1/2	I.D. 6	40.5	14.5	24
134837	MS239A1208	G 1/2	I.D. 8	40.5	14.5	24
134838	MS239A1209	G 1/2	I.D. 9	40.5	14.5	24
134839	MS239A1210	G 1/2	I.D. 10	42.5	14.5	24
134840	MS239A1212	G 1/2	I.D. 12	42.5	14.5	24
134841	MS239A1213	G 1/2	I.D. 13	42.5	14.5	24
134843	MS239A1216	G 1/2	I.D. 16	46.5	14.5	24
134844	MS239A1219	G 1/2	I.D. 19	46.5	14.5	24
134845	MS239A3409	G 3/4	I.D. 9	43.0	17.0	32
134846	MS239A3413	G 3/4	I.D. 13	45.0	17.0	32
134847	MS239A3416	G 3/4	I.D. 16	49.0	17.0	32
134848	MS239A3419	G 3/4	I.D. 19	49.0	17.0	32
134849	MS239A3425	G 3/4	I.D. 25	56.0	17.0	32
134850	MS239A119	G 1	I.D. 19	51.5	19.5	38
134851	MS239A125	G 1	I.D. 25	58.5	19.5	38
134852	MS239A132	G 1	I.D. 32	58.5	19.5	38
134853	MS239A11432	G 1 1/4	I.D. 32	60.0	21.0	50
134854	MS239A11438	G 1 1/4	I.D. 38	67.0	21.0	50
134855	MS239A11232	G 1 1/2	I.D. 32	60.0	21.0	55
134856	MS239A11238	G 1 1/2	I.D. 38	67.0	21.0	55
134857	MS239A11250	G 1 1/2	I.D. 50	67.0	21.0	55
134858	MS239A250	G 2	I.D. 50	74.0	28.0	70

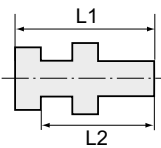

MS2323814

Bulkhead connectors

brass

PLUS

Bulkhead connector

Art. No.	Type No.	Male thread	Female thread	L1 mm	L2 mm	a/f 1 mm	a/f 2 mm
136276	MS232M1618	M16x1.5	G 1/8	24.0	19.0	17	22
136277	MS232M2014	M20x1.5	G 1/4	29.0	23.0	22	27
136278	MS232M2638	M26x1.5	G 3/8	28.0	22.0	27	32
136279	MS232M2812	M28x1.5	G 1/2	30.0	24.0	30	36
136280	MS232M3434	M34x2	G 3/4	31.0	25.0	38	41
136281	MS232M421	M42x2	G 1	34.0	27.0	45	50
136282	MS232M49114	M49x2	G 1 1/4	39.0	31.0	55	60
136283	MS232M54112	M54x2	G 1 1/2	46.0	38.0	60	65

Bulkhead connectors

brass

PLUS

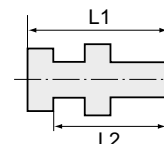

Bulkhead connector

Art. No.	Type No.	Male thread	Female thread	L1 mm	L2 mm	a/f 1 mm	a/f 2 mm
136284	MS23218M5	G 1/8	M5	16.0	12.0	12	14
136285	MS2321418	G 1/4	G 1/8	16.0	14.0	17	17
136286	MS2323814	G 3/8	G 1/4	22.0	17.0	19	19
136287	MS2321238	G 1/2	G 3/8	27.0	21.0	24	24
136288	MS2323412	G 3/4	G 1/2	27.0	21.0	30	32
136289	MS232134	G 1	G 3/4	31.0	25.0	38	41

Hose fittings

brass

PLUS

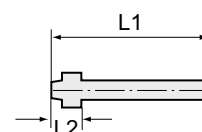

Hose fitting with ball nipple

Art. No.	Type No.	For hose mm	For swivel nut type no.	L1 mm	L2 mm
134835	MS2361804	I.D. 4	MS2341846	37.0	6.0
134842	MS2361806	I.D. 6	MS2341846	37.0	6.0
133997	MS2361404	I.D. 4	MS2341446 + MS234LH1446	37.5	6.5
133998	MS2361406	I.D. 6	MS2341446 + MS234LH1446	36.5	6.5
134003	MS2361409	I.D. 9	MS2341409	37.5	6.5
134006	MS2363804	I.D. 4	MS23438469 + MS234LH38469	35.0	8.0
134895	MS2363806	I.D. 6	MS23438469 + MS234LH38469	39.0	8.0
134902	MS2363809	I.D. 9	MS23438469 + MS234LH38469	39.0	8.0
137522	MS2361206	I.D. 6	MS2341269	39.0	8.0
136301	MS2361208	I.D. 8	MS2341269	39.0	8.0
137523	MS2361209	I.D. 9	MS2341269	39.0	8.0
136302	MS2361210	I.D. 10	MS2341269	41.0	8.0
136303	MS2361212	I.D. 12	MS2341213	41.0	8.0
137524	MS2361213	I.D. 13	MS2341213 + MS234LH1213	41.0	8.0
136304	MS2363413	I.D. 13	MS2343419	42.0	9.0
136305	MS2363419	I.D. 19	MS2343419	46.0	9.0
136306	MS236119	I.D. 19	MS234119	47.0	10.0
136307	MS236125	I.D. 25	MS234125	54.0	10.0



MS2361404



Swivel nuts

brass

PLUS



MS2341409

Hexagonal swivel nut

Art. No.	Type No.	Thread	For fitting type no.	L1 mm	a/f mm
137525	MS2341846	G 1/8	MS2361804 + MS2361806	13.0	14
137526	MS2341446	G 1/4	MS2361404 + MS2361406	15.0	17
137527	MS2341409	G 1/4	MS2361409	15.0	17
137528	MS23438469	G 3/8	MS2363804 + MS2363806 + MS2363809	15.0	19
137529	MS2341269	G 1/2	MS2361206 + MS2361208 + MS2361209 + MS2361210	18.0	24
137530	MS2341213	G 1/2	MS2361212 + MS2361213	18.0	24
136309	MS2343419	G 3/4	MS2363419	18.0	32
136310	MS234119	G 1	MS236119	21.0	38
136311	MS234125	G 1	MS236125	21.0	38



MS234LH1446

Hexagonal swivel nut, left-hand thread

Art. No.	Type No.	Thread	For fitting type no.	L1 mm	a/f mm
137630	MS234LH1446	G 1/4 ccw	MS2361404 + MS2361406	15.0	17
137631	MS234LH38469	G 3/8 ccw	MS2363804 + MS2363806 + MS2363809	15.0	19
137632	MS234LH1213	G 1/2 ccw	MS2361212 + MS2361213	18.0	24

Lock nuts

brass

PLUS



MS23814

Hexagonal lock nut

Art. No.	Type No.	Thread	L1 mm	a/f mm
137599	MS23818	G 1/8	3.5	14
137600	MS23814	G 1/4	3.5	17
137601	MS23838	G 3/8	4.5	19
137602	MS23812	G 1/2	5.0	24
137603	MS23834	G 3/4	5.0	32
137604	MS2381	G 1	6.0	41
137605	MS238114	G 1 1/4	8.5	50
137606	MS238112	G 1 1/2	9.0	58
137607	MS2382	G 2	11.0	70
137608	MS238M10	M10x1.0	3.5	14
137609	MS238M12	M12x1.0	5.0	17
137610	MS238M14	M14x1.0	5.0	19
137611	MS238M16	M16x1.0	5.0	22
137612	MS238M20	M20x1.5	6.0	27
137613	MS238M22	M22x1.0	5.0	27
137614	MS238M28	M28x1.5	6.0	38
136312	MS238M24	M24x2	6.0	28
136313	MS238M42	M42x2	7.0	50
136314	MS238M49	M49x2	8.0	60
136315	MS238M54	M54x2	9.0	65

Caps

brass

PLUS

Hexagonal cap					
Art. No.	Type No.	Thread	L1 mm	a/f mm	
137891	MSVK18	G 1/8	10.0	13	
137892	MSVK14	G 1/4	10.0	16	
137893	MSVK38	G 3/8	10.0	19	
137894	MSVK12	G 1/2	12.0	23	
137895	MSVK34	G 3/4	14.0	29	
137896	MSVK1	G 1	15.0	36	
137897	MSVK114	G 1 1/4	17.0	47	
137898	MSVK112	G 1 1/2	20.0	53	
137899	MSVK2	G 2	20.0	64	
136316	MSVK212	G 2 1/2	20.0	85	
136317	MSVK3	G 3	20.0	95	



MSVK14

Swivel hose fittings

brass

PLUS

Working pressure	0.95 - 15 bar
Temperature range	-10 to 70 °C
Material	Nickel-plated brass (banjo bolt), brass (ring nipple)

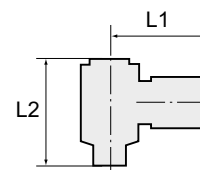

Swivel hose fitting, parallel male thread						
Art. No.	Type No.	Thread	For hose mm	L1 mm	L2 mm	a/f mm
111323	74-024	G 1/8	I.D. 4	26.0	28.6	14
111324	74-026	G 1/8	I.D. 6	26.0	28.6	14
111325	74-046	G 1/4	I.D. 6	28.0	30.5	17
111326	74-049	G 1/4	I.D. 9	28.0	30.5	17
111327	74-066	G 3/8	I.D. 6	30.0	31.5	22
111328	74-069	G 3/8	I.D. 9	30.0	31.5	22



74-049



Boxed set, brass turned parts

PLUS

Practical, high-quality assortment of the most popular hose fittings, sockets, double nipples, reducing nipples, plugs and lock nuts in our range of brass turned parts, packaged in a sturdy plastic case. Total of 35 different small part types, conveniently arranged in 21 plastic compartments. The inserts can be removed and rearranged inside the case according to individual needs. All inserts are labelled with the article numbers of the parts they contain.

Parts included:

30 male hose fittings G 1/4-6 • G 1/4-9 • G 3/8-6 • G 3/8-9 • G 1/2-9 • G 1/2-13
 38 double nipples G 1/8 x G 1/8 • G 1/8 x G 1/4 • G 1/4 x G 1/4 • G 1/4 x G 3/8 • G 3/8 x G 3/8 • G 3/8 x G 1/2 • G 1/2 x G 1/2 • G 1/2 x G 3/4
 19 reducing nipples G 1/4 m x G 1/8 f • G 3/8 m x G 1/4 f • G 1/2 m x G 3/8 f • G 3/4 m x G 1/2 f
 18 sockets G 1/8 • G 1/4 • G 3/8 • G 1/2 20 plugs G 1/8 • G 1/4 • G 3/8 • G 1/2
 15 double hose fittings 6, 9, 13 mm
 20 lock nuts G 1/8 • G 1/4 • G 3/8 • G 1/2
 1 thread adhesive 10 ml
 1 PTFE sealing tape



DTB 300

Boxed sets, brass turned parts

Art. No.	Type No.	Description
111329	DTB 300	Boxed set, brass turned parts

- Boxed set quick disconnect couplings DN 7.2 see on page 652
- Boxed sets, »Blue Series« push-in fittings see at page 499-500
- Boxed set, »click-clock« Series push-in fittings see at page 626
- Boxed sets, hose clamps see at page 887

Boxed set, brass turned parts

reduced assortment

PLUS

Easy to handle plastic assortment box with reduced fitting, includes the most common sleeves, double nipples and reducing nipples of our brass rotating parts product range.

Parts included:

38 male hose fittings G 1/4-6 • G 1/4-9 • G 3/8-9 • G 1/2-9 • G 1/2-13
 32 double nipples G 1/4 x G 1/4 • G 3/8 x G 3/8 • G 1/2 x G 1/2
 50 reducing nipples G 1/4 o. x G 1/8 i. • G 3/8 o. x G 1/4 i. • G 1/2 o. x G 3/8 i. • G 1/2 o. x G 1/4 i.



DTBR 300

Boxed set, brass turned parts

Art. No.	Type No.	Description
131537	DTBR 300	Boxed set, brass turned parts with reduced assortment

- Boxed set quick disconnect couplings DN 7.2 see on page 499-500
- Boxed sets, »Blue Series« push-in fittings see at page 626
- Boxed set, »click-clock« Series push-in fittings see at page 652
- Boxed sets, hose clamps see at page 887

Standard screw fittings

nickel-plated brass

Suitable for air, water, oil, steam, etc.

Max. working pressure	25 bar
Material	Nickel-plated brass CW614N

Reducing nipples

nickel-plated brass

PLUS

Reducing nipple, short type, parallel

Art. No.	Type No.	Male thread	Female thread	Max. operating temperature °C	L1 mm	L2 mm	a/f mm
134710	MSN251K1418	G 1/4	G 1/8	150	14.0	9.0	17
134711	MSN251K3818	G 3/8	G 1/8	150	14.0	9.0	19
134712	MSN251K3814	G 3/8	G 1/4	150	14.0	9.0	19
134713	MSN251K1218	G 1/2	G 1/8	150	17.0	11.0	24
134714	MSN251K1214	G 1/2	G 1/4	150	17.0	11.0	24
134715	MSN251K1238	G 1/2	G 3/8	150	17.0	11.0	24
134716	MSN251K3414	G 3/4	G 1/4	150	18.0	12.0	32
134717	MSN251K3438	G 3/4	G 3/8	150	18.0	12.0	32
134718	MSN251K3412	G 3/4	G 1/2	150	18.0	12.0	32
134719	MSN251K0112	G 1	G 1/2	150	19.0	13.0	38
134720	MSN251K0134	G 1	G 3/4	150	19.0	13.0	38
134721	MSN251K11434	G 1 1/4	G 3/4	150	21.0	14.0	50
134722	MSN251K1141	G 1 1/4	G 1	150	21.0	14.0	50
134723	MSN251K11234	G 1 1/2	G 3/4	150	23.0	15.0	55
134724	MSN251K1121	G 1 1/2	G 1	150	23.0	15.0	55
134725	MSN251K112114	G 1 1/2	G 1 1/4	150	23.0	15.0	55
134726	MSN251K21	G 2	G 1	150	28.0	20.0	70
134727	MSN251K2114	G 2	G 1 1/4	150	28.0	20.0	70
134728	MSN251K2112	G 2	G 1 1/2	150	28.0	20.0	70
134729	MSN251K212112	G 2 1/2	G 1 1/2	150	32.0	23.0	80
134730	MSN251K2122	G 2 1/2	G 2	150	32.0	23.0	80
134731	MSN251K31	G 3	G 1	150	36.0	26.0	95
134732	MSN251K3114	G 3	G 1 1/4	150	36.0	26.0	95
134733	MSN251K3112	G 3	G 1 1/2	150	36.0	26.0	95
134734	MSN251K32	G 3	G 2	150	36.0	26.0	95
134735	MSN251K3212	G 3	G 2 1/2	150	36.0	26.0	95

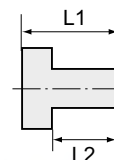

MSN251K1418

Reducing nipple, short type

Art. No.	Type No.	Male thread	Female thread	Max. operating temperature °C	L1 mm	L2 mm	a/f mm
134736	MSN251KM53	M5	M3	150	8.0	5.0	7
134737	MSN251KM1410	M14x1.5	M10x1.0	150	14.0	9.0	17
134738	MSN251KM2416	M24x1.5	M16x1.5	150	24.0	16.0	28
134739	MSN251K18M5	G 1/8	M5	150	11.0	7.0	14
134740	MSN251K14M5	G 1/4	M5	150	14.0	9.0	17



MSN251KM53



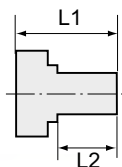

MSN251L1418

Reducing nipples

nickel-plated brass

PLUS ||

Reducing nipple, long type, parallel

Art. No.	Type No.	Male thread	Female thread	Max. operating temperature °C	L1 mm	L2 mm	a/f mm
134741	MSN251L1818	G 1/8	G 1/8	150	19.0	7.0	14
134742	MSN251L1814	G 1/8	G 1/4	150	23.0	7.0	17
134743	MSN251L1418	G 1/4	G 1/8	150	22.0	9.0	17
134744	MSN251L1414	G 1/4	G 1/4	150	24.0	9.0	17
134745	MSN251L1438	G 1/4	G 3/8	150	27.0	9.0	19
134746	MSN251L3814	G 3/8	G 1/4	150	23.0	9.0	19
134747	MSN251L3838	G 3/8	G 3/8	150	24.0	9.0	19
134748	MSN251L3812	G 3/8	G 1/2	150	29.0	9.0	24
134749	MSN251L1238	G 1/2	G 3/8	150	26.0	11.0	24
134750	MSN251L1212	G 1/2	G 1/2	150	29.0	11.0	24
134751	MSN251L1234	G 1/2	G 3/4	150	32.0	11.0	32
134752	MSN251L3412	G 3/4	G 1/2	150	29.0	12.0	32
134753	MSN251L3434	G 3/4	G 3/4	150	34.0	12.0	32
134754	MSN251L341	G 3/4	G 1	150	34.0	12.0	36
134755	MSN251L134	G 1	G 3/4	150	35.0	13.0	38
134756	MSN251L11	G 1	G 1	150	33.0	13.0	38
134757	MSN251L1114	G 1	G 1 1/4	150	37.0	13.0	50
134758	MSN251L1141	G 1 1/4	G 1	150	36.0	14.0	50
134759	MSN251L114114	G 1 1/4	G 1 1/4	150	36.0	14.0	50
134760	MSN251L114112	G 1 1/4	G 1 1/2	150	38.0	14.0	55
134761	MSN251L112114	G 1 1/2	G 1 1/4	150	35.0	15.0	55
134762	MSN251L112112	G 1 1/2	G 1 1/2	150	37.0	15.0	55
134763	MSN251L1122	G 1 1/2	G 2	150	46.0	15.0	70
134764	MSN251L2114	G 2	G 1 1/4	150	48.0	20.0	70
134765	MSN251L2112	G 2	G 1 1/2	150	48.0	20.0	70



MSN251L18M5

Reducing nipple, long type

Art. No.	Type No.	Male thread	Female thread	Max. operating temperature °C	L1 mm	L2 mm	a/f mm
134766	MSN251LM35	M3	M5	150	11.0	3.0	7
134767	MSN251LM53	M5	M3	150	13.0	5.0	7
134768	MSN251LM55	M5	M5	150	13.0	5.0	7
134769	MSN251LM518	M5	G 1/8	150	19.0	5.0	14
134770	MSN251L18M5	G 1/8	M5	150	17.0	7.0	14

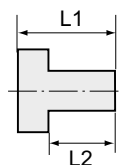

235.04/N

Reducing nipples

nickel-plated brass

PLUS ||

Reducing nipple, conical male thread, parallel female thread

Art. No.	Type No.	Male thread	Female thread	Max. operating temperature °C	L1 mm	L2 mm	a/f mm
111340	235.01/N	R 1/4	G 1/8	150	16.0	11.0	14
111341	235.02/N	R 3/8	G 1/8	150	17.0	11.5	17
111342	235.03/N	R 3/8	G 1/4	150	17.0	11.5	17
111343	235.04/N	R 1/2	G 1/8	150	19.5	14.0	22

Reducing nipples

nickel-plated brass

PLUS

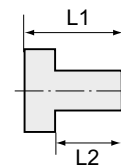

Reducing nipple, conical male thread, parallel female thread

Art. No.	Type No.	Male thread	Female thread	Max. operating temperature °C	L1 mm	L2 mm	a/f mm
111344	235.05/N	R 1/2	G 1/4	150	20.0	14.0	22
111345	235.06/N	R 1/2	G 3/8	150	20.0	14.0	22
111346	235.07/N	R 3/4	G 3/8	150	23.0	16.5	27
111347	235.08/N	R 3/4	G 1/2	150	23.0	16.5	27
111348	235.09/N	R 1	G 1/2	150	25.0	16.0	34
111349	235.10/N	R 1	G 3/4	150	25.0	18.0	34

Double nipples

nickel-plated brass

PLUS

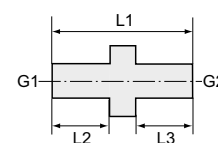

Double nipple, parallel male thread

Art. No.	Type No.	Thread 1	Thread 2	Max. operating temperature °C	L1 mm	L2 mm	L3 mm	a/f mm
131891	MSN2521818	G 1/8	G 1/8	150	18.0	7.0	7.0	14
131892	MSN2521814	G 1/8	G 1/4	150	21.0	7.0	9.0	17
131893	MSN2521838	G 1/8	G 3/8	150	21.0	7.0	9.0	19
131894	MSN2521414	G 1/4	G 1/4	150	23.0	9.0	9.0	17
131895	MSN2521438	G 1/4	G 3/8	150	23.0	9.0	9.0	19
131896	MSN2521412	G 1/4	G 1/2	150	26.0	9.0	11.0	24
131897	MSN2523838	G 3/8	G 3/8	150	23.0	9.0	9.0	19
131898	MSN2523812	G 3/8	G 1/2	150	26.0	9.0	11.0	24
131899	MSN2523834	G 3/8	G 3/4	150	27.0	9.0	12.0	32
134283	MSN252381	G 3/8	G 1	150	28.0	9.0	13.0	38
131900	MSN2521212	G 1/2	G 1/2	150	28.0	11.0	11.0	24
131901	MSN2521234	G 1/2	G 3/4	150	29.0	11.0	12.0	32
131902	MSN252121	G 1/2	G 1	150	30.0	11.0	13.0	38
131904	MSN2523434	G 3/4	G 3/4	150	30.0	12.0	12.0	32
131903	MSN252341	G 3/4	G 1	150	31.0	12.0	13.0	38
131905	MSN25211	G 1	G 1	150	32.0	13.0	13.0	38
131906	MSN2521114	G 1	G 1 1/4	150	34.0	13.0	14.0	50
131907	MSN2521112	G 1	G 1 1/2	150	36.0	13.0	15.0	55
131908	MSN25212	G 1	G 2	150	41.0	13.0	20.0	70
134289	MSN25211412	G 1 1/4	G 1/2	150	32.0	14.0	11.0	50
134287	MSN25211434	G 1 1/4	G 3/4	150	33.0	14.0	12.0	50
131909	MSN252114114	G 1 1/4	G 1 1/4	150	35.0	14.0	14.0	50
131910	MSN252114112	G 1 1/4	G 1 1/2	150	37.0	14.0	15.0	55
131911	MSN2521142	G 1 1/4	G 2	150	42.0	14.0	20.0	70
134288	MSN25211234	G 1 1/2	G 3/4	150	34.0	15.0	12.0	50
131912	MSN252112112	G 1 1/2	G 1 1/2	150	38.0	15.0	15.0	55
131913	MSN2521122	G 1 1/2	G 2	150	43.0	15.0	20.0	70
131914	MSN25222	G 2	G 2	150	48.0	20.0	20.0	70
131915	MSN2522212	G 2	G 2 1/2	150	53.0	20.0	23.0	80
131916	MSN25223	G 2	G 3	150	57.0	20.0	26.0	95
131917	MSN252212212	G 2 1/2	G 2 1/2	150	56.0	23.0	23.0	80
131918	MSN2522123	G 2 1/2	G 3	150	60.0	23.0	26.0	95
131920	MSN25233	G 3	G 3	150	63.0	26.0	26.0	95



MSN2521818



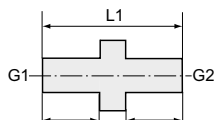

Double nipples

nickel-plated brass

PLUS



MSN25214M14



MSN252R1438

Double nipple, male thread

Art. No.	Type No.	Thread 1	Thread 2	Max. operating temperature °C	L1 mm	L2 mm	L3 mm	a/f mm
134771	MSN252M33	M3	M3	150	9.0	3.0	3.0	5
134772	MSN252M53	M5	M3	150	11.0	5.0	3.0	7
134773	MSN252M1414	M14x1.5	M14x1.5	150	23.0	9.0	9.0	17
134774	MSN252M1616	M16x1.5	M16x1.5	150	23.0	9.0	9.0	19
134775	MSN252M2424	M24x1.5	M24x1.5	150	40.0	16.0	16.0	28
134776	MSN252M55	M5	M5	150	13.0	5.0	5.0	7
134777	MSN252M518	M5	G 1/8	150	16.0	5.0	7.0	14
134778	MSN252M514	M5	G 1/4	150	19.0	5.0	9.0	17
134779	MSN25214M14	G 1/4	M14x1.5	150	23.0	9.0	9.0	17
134780	MSN25238M16	G 3/8	M16x1.5	150	23.0	9.0	9.0	19
134781	MSN25212M24	G 1/2	M24x1.5	150	33.0	11.0	16.0	28

Double nipple, conical male thread

Art. No.	Type No.	Thread 1	Thread 2	Max. operating temperature °C	L1 mm	L2 mm	L3 mm	a/f mm
134782	MSN252R1818	R 1/8	R 1/8	150	20.0	8.0	8.0	12
134783	MSN252R1814	R 1/8	R 1/4	150	23.0	8.0	11.0	14
134784	MSN252R1838	R 1/8	R 3/8	150	24.0	8.0	11.0	19
134785	MSN252R1414	R 1/4	R 1/4	150	26.0	11.0	11.0	14
134786	MSN252R1438	R 1/4	R 3/8	150	27.0	11.0	11.0	19
134787	MSN252R1412	R 1/4	R 1/2	150	31.0	11.0	14.0	22
134788	MSN252R3838	R 3/8	R 3/8	150	27.0	11.0	11.0	19
100835	252.302-N	R 3/8	R 3/8	150	38.0	16.0	16.0	22
134789	MSN252R3812	R 3/8	R 1/2	150	31.0	11.0	14.0	22
134790	MSN252R3834	R 3/8	R 3/4	150	33.0	11.0	16.0	28
134791	MSN252R381	R 3/8	R 1	150	35.0	11.0	18.0	36
134792	MSN252R1212	R 1/2	R 1/2	150	34.0	14.0	14.0	22
134793	MSN252R1234	R 1/2	R 3/4	150	36.0	14.0	16.0	28
134794	MSN252R121	R 1/2	R 1	150	38.0	14.0	18.0	36
134795	MSN252R3434	R 3/4	R 3/4	150	38.0	16.0	16.0	28
134796	MSN252R341	R 3/4	R 1	150	40.0	16.0	18.0	36
134797	MSN252R11	R 1	R 1	150	42.0	18.0	18.0	36
134798	MSN252R1114	R 1	R 1 1/4	150	45.0	18.0	20.0	44
134799	MSN252R1112	R 1	R 1 1/2	150	45.0	18.0	20.0	50
134800	MSN252R12	R 1	R 2	150	51.0	18.0	25.0	62
134801	MSN252R11412	R 1 1/4	R 1/2	150	41.0	20.0	14.0	44
134802	MSN252R11434	R 1 1/4	R 3/4	150	43.0	20.0	16.0	44
134803	MSN252R114114	R 1 1/4	R 1 1/4	150	47.0	20.0	20.0	44
134804	MSN252R114112	R 1 1/4	R 1 1/2	150	47.0	20.0	20.0	50
134805	MSN252R1142	R 1 1/4	R 2	150	53.0	20.0	25.0	62
134806	MSN252R11234	R 1 1/2	R 3/4	150	43.0	20.0	16.0	50
134807	MSN252R112112	R 1 1/2	R 1 1/2	150	47.0	20.0	20.0	50
134808	MSN252R1122	R 1 1/2	R 2	150	53.0	20.0	25.0	62
134809	MSN252R22	R 2	R 2	150	58.0	25.0	25.0	62

Screw plugs

nickel-plated brass

PLUS

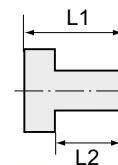

Hexagon socket screw plug with collar						
Art. No.	Type No.	Thread	Max. operating temperature °C	L1 mm	L2 mm	a/f mm
137910	MSN290MS18	G 1/8 hexagon socket head	150	10.0	7.0	5
137911	MSN290MS14	G 1/4 hexagon socket head	150	12.0	9.0	6
137912	MSN290MS38	G 3/8 hexagon socket head	150	12.0	9.0	8
137913	MSN290MS12	G 1/2 hexagon socket head	150	15.0	11.0	10
137914	MSN290MS34	G 3/4 hexagon socket head	150	16.0	12.0	12
137915	MSN290MS1	G 1 hexagon socket head	150	18.0	13.0	17
136437	MSN290MS114	G 1 1/4 hexagon socket head	150	19.0	14.0	22
136438	MSN290MS112	G 1 1/2 hexagon socket head	150	20.0	15.0	24
136439	MSN290MS2	G 2 hexagon socket head	150	25.0	20.0	27



Hexagon socket screw plug without collar						
Art. No.	Type No.	Thread	Max. operating temperature °C	L1 mm		a/f mm
136440	MSN290OBM8	M8x0.75 hexagon socket head	150	8.0		4
136441	MSN290OBM10	M10x1.0 hexagon socket head	150	8.0		5
136442	MSN290OBM12	M12x1.5 hexagon socket head	150	8.0		6
136443	MSN290OBM14	M14x1.5 hexagon socket head	150	10.0		7
136444	MSN290OB18	G 1/8 hexagon socket head	150	8.0		5
136445	MSN290OB14	G 1/4 hexagon socket head	150	10.0		7
136446	MSN290OB38	G 3/8 hexagon socket head	150	12.0		8
136447	MSN290OB12	G 1/2 hexagon socket head	150	14.0		10
136448	MSN290OB34	G 3/4 hexagon socket head	150	16.0		12
136449	MSN290OB1	G 1 hexagon socket head	150	18.0		17
136450	MSN290OB114	G 1 1/4 hexagon socket head	150	20.0		22
136451	MSN290OB112	G 1 1/2 hexagon socket head	150	22.0		24
136452	MSN290OB2	G 2 hexagon socket head	150	24.0		32



Hexagon socket screw plug without collar						
Art. No.	Type No.	Thread	Max. operating temperature °C	L1 mm		a/f mm
137938	MSN290ROB18	R 1/8 hexagon socket head	150	8.0		5
137939	MSN290ROB14	R 1/4 hexagon socket head	150	10.0		6
137940	MSN290ROB38	R 3/8 hexagon socket head	150	10.0		8
137941	MSN290ROB12	R 1/2 hexagon socket head	150	10.0		10
136453	MSN290ROB34	R 3/4 hexagon socket head	150	12.0		12
136454	MSN290ROB1	R 1 hexagon socket head	150	12.0		17
136455	MSN290ROB114	R 1 1/4 hexagon socket head	150	18.0		22
136456	MSN290ROB112	R 1 1/2 hexagon socket head	150	20.0		24
136458	MSN290ROB2	R 2 hexagon socket head	150	22.0		32



Hexagon head screw plug						
Art. No.	Type No.	Thread	Max. operating temperature °C	L1 mm	L2 mm	a/f mm
137947	MSN290SKM5	M5 hexagon head	150	7.0	4.0	8
137948	MSN290SK18	G 1/8 hexagon head	150	11.0	7.0	14
137949	MSN290SK14	G 1/4 hexagon head	150	15.0	9.0	17
137950	MSN290SK38	G 3/8 hexagon head	150	15.0	9.0	19
137951	MSN290SK12	G 1/2 hexagon head	150	17.0	11.0	24
137952	MSN290SK34	G 3/4 hexagon head	150	20.0	12.0	32
137953	MSN290SK1	G 1 hexagon head	150	21.0	13.0	36
136459	MSN290SK114	G 1 1/4 hexagon head	150	22.0	14.0	50
136460	MSN290SK112	G 1 1/2 hexagon head	150	23.0	15.0	55
136461	MSN290SK2	G 2 hexagon head	150	28.0	20.0	70



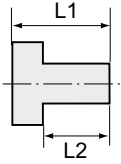

Screw plugs

nickel-plated brass

PLUS



MSN290SKMB14

Hexagon head screw plug with collar

Art. No.	Type No.	Thread	Max. operating temperature °C	L1 mm	L2 mm	a/f mm
136462	MSN290SKMB18	G 1/8 hexagon head	150	16.0	7.0	10
136463	MSN290SKMB14	G 1/4 hexagon head	150	18.0	9.0	13
136464	MSN290SKMB38	G 3/8 hexagon head	150	18.0	9.0	17
136465	MSN290SKMB12	G 1/2 hexagon head	150	23.0	11.0	19
136466	MSN290SKMB34	G 3/4 hexagon head	150	26.0	12.0	24
136467	MSN290SKMB1	G 1 hexagon head	150	29.0	13.0	27
136468	MSN290SKMB114	G 1 1/4 hexagon head	150	31.0	14.0	30
136469	MSN290SKMB112	G 1 1/2 hexagon head	150	32.0	15.0	30
136470	MSN290SKMB2	G 2 hexagon head	150	40.0	20.0	36



233.03-N

Hexagon socket screw plug with NBR O-ring

Art. No.	Type No.	Thread	Max. operating temperature °C	L1 mm	L2 mm	Hexagon socket head mm
111408	233.01-N	M5 hexagon socket head	80	6.5	4.0	2.5
111409	233.02-N	G 1/8 hexagon socket head	80	9.5	7.0	3
111410	233.03-N	G 1/4 hexagon socket head	80	11.0	8.0	6
111411	233.04-N	G 3/8 hexagon socket head	80	12.5	9.0	8
111412	233.05-N	G 1/2 hexagon socket head	80	14.5	11.0	10
111413	233.06-N	G 3/4 hexagon socket head	80	20.0	15.5	17
111414	233.07-N	G 1 hexagon socket head	80	21.0	16.0	19

Detachable double nipples

nickel-plated brass

PLUS



MSN252L1414

Detachable double nipple, male, taper seat

Art. No.	Type No.	Thread 1	Thread 2	Max. operating temperature °C	L1 mm	a/f mm	a/f 1 mm
136556	MSN252L1818	R 1/8	R 1/8	150	27.0	15	5
136557	MSN252L1814	R 1/8	R 1/4	150	30.0	15	5
136558	MSN252L1414	R 1/4	R 1/4	150	33.0	19	6
136559	MSN252L1438	R 1/4	R 3/8	150	34.0	19	6
136560	MSN252L3838	R 3/8	R 3/8	150	37.0	22	8
136561	MSN252L1212	R 1/2	R 1/2	150	44.5	27	12
136562	MSN252L3434	R 3/4	R 3/4	150	53.0	36	14
136563	MSN252L11	R 1	R 1	150	59.0	50	19
136564	MSN252L114114	R 1 1/4	R 1 1/4	150	68.0	60	22
136565	MSN252L112112	R 1 1/2	R 1 1/2	150	75.0	70	24
136566	MSN252L22	R 2	R 2	150	85.0	80	32

Sockets with outer hex

nickel-plated brass

PLUS

Socket with outer hex						
Art. No.	Type No.	Thread		Max. operating temperature °C	L1 mm	a/f mm
138460	MSN252MUM5	M5		150	11.0	8
138461	MSN252MU18	G 1/8		150	22.0	14
138462	MSN252MU14	G 1/4		150	26.0	17
138463	MSN252MU38	G 3/8		150	26.0	22
138464	MSN252MU12	G 1/2		150	30.0	27
138465	MSN252MU34	G 3/4		150	36.0	32
138466	MSN252MU1	G 1		150	40.0	41
136567	MSN252MU114	G 1 1/4		150	45.0	50
136568	MSN252MU112	G 1 1/2		150	50.0	55
136569	MSN252MU2	G 2		150	55.0	70



MSN252MU14

Socket with outer hex, reduced						
Art. No.	Type No.	Thread 1	Thread 2	Max. operating temperature °C	L1 mm	a/f mm
136570	MSN252MU1814	G 1/8	G 1/4	150	26.0	17
136571	MSN252MU1438	G 1/4	G 3/8	150	26.0	22
136572	MSN252MU3812	G 3/8	G 1/2	150	30.0	27
136573	MSN252MU12M14	G 1/2	M14x1.5	150	30.0	27
136574	MSN252MU12M16	G 1/2	M16x1.5	150	24.0	27
136575	MSN252MU34M14	G 3/4	M14x1.5	150	28.0	32
136576	MSN252MU34M16	G 3/4	M16x1.5	150	28.0	32



MSN252MU1438

Sockets

nickel-plated brass

PLUS

Socket, reduced, 2 x female thread						
Art. No.	Type No.	Thread 1	Thread 2	Max. operating temperature °C	L1 mm	a/f mm
111520	231.01-N	M5	G 1/8	150	13.5	14
111521	231.02-N	G 1/8	G 1/4	150	21.5	17
111522	231.03-N	G 1/8	G 3/8	150	23.5	22
111523	231.04-N	G 1/4	G 3/8	150	25.5	22
111524	231.05-N	G 1/4	G 1/2	150	28.5	24
111525	231.06-N	G 3/8	G 1/2	150	29.5	24
111526	231.07-N	G 1/2	G 3/4	150	30.0	32
111527	231.08-N	G 1/2	G 1/8	150	24.0	24
111528	231.09-n	G 1	G 3/4	150	25.0	38

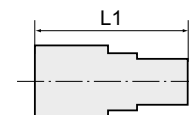

231.04-N



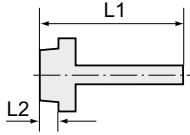

Male hose fittings

nickel-plated brass

PLUS



239.507

Male hose fitting, parallel, with O-ring

Art. No.	Type No.	Thread	For hose mm	Max. operating temperature °C	L1 mm	L2 mm	a/f mm
111467	239.501	G 1/8	I.D. 5	80	30.0	6.5	14
111468	239.502	G 1/8	I.D. 7	80	31.0	6.0	15
111469	239.503	G 1/8	I.D. 8	80	31.0	6.0	15
111470	239.505	G 1/4	I.D. 5	80	32.0	8.0	17
111471	N239.506-N	G 1/4	I.D. 7	80	32.0	8.0	17
111472	239.507	G 1/4	I.D. 8	80	33.0	8.0	18
111473	N239.508-N	G 1/4	I.D. 9	80	33.0	8.0	17
111474	239.509	G 1/4	I.D. 11	80	33.0	8.0	18
111475	N239.520-N	G 1/4	I.D. 12	80	33.0	8.0	17
111476	N239.521-N	G 3/8	I.D. 5	80	33.0	9.0	20
111477	N239.522-N	G 3/8	I.D. 7	80	33.0	9.0	20
111478	239.510	G 3/8	I.D. 8	80	34.0	9.0	21
111479	N239.511-N	G 3/8	I.D. 9	80	34.0	9.0	20
111480	239.512	G 3/8	I.D. 11	80	34.0	9.0	21
111481	N239.513-N	G 3/8	I.D. 12	80	34.0	9.0	20
117830	NEW 239.3813.MSN.OR	G 3/8	LW 13	80	38.0	9.0	20
117849	NEW 239.3815.MSN.OR	G 3/8	LW 15	80	38.0	9.0	20
117870	NEW 239.3816.MSN.OR	G 3/8	LW 16	80	34.0	9.0	21
111482	239.515	G 1/2	I.D. 11	80	36.0	11.0	26
111483	N239.516-N	G 1/2	I.D. 12	80	36.0	10.0	24
117810	NEW 239.1213.MSN.OR	G 1/2	LW 13	80	40.0	10.0	25
111484	N239.517-N	G 1/2	I.D. 15	80	40.0	10.0	25
117859	NEW 239.1216.MSN.OR	G 1/2	LW 16	80	36.0	11.0	26
111485	N239.518-N	G 1/2	I.D. 18	80	40.0	10.0	24
117877	NEW 239.1219.MSN.OR	G 1/2	LW 19	80	40.0	10.0	25

Male hose fittings

nickel-plated brass

PLUS



MSN2391404

Male hose fitting with parallel male thread

Art. No.	Type No.	Thread	For hose mm	Max. operating temperature °C	L1 mm	L2 mm	a/f mm
131039	MSN2391804	G 1/8	I.D. 4	150	37.0	7.0	14
131040	MSN2391806	G 1/8	I.D. 6	150	37.0	7.0	14
131041	MSN2391808	G 1/8	I.D. 8	150	37.0	7.0	14
131042	MSN2391809	G 1/8	I.D. 9	150	37.0	7.0	14
133999	MSN2391810	G 1/8	I.D. 10	150	39.0	7.0	14
131043	MSN2391404	G 1/4	I.D. 4	150	40.0	9.0	17
131044	MSN2391406	G 1/4	I.D. 6	150	40.0	9.0	17
131045	MSN2391408	G 1/4	I.D. 8	150	40.0	9.0	17
131046	MSN2391409	G 1/4	I.D. 9	150	40.0	9.0	17
131047	MSN2391410	G 1/4	I.D. 10	150	42.0	9.0	17
134000	MSN2391412	G 1/4	I.D. 12	150	42.0	9.0	17
131048	MSN2391413	G 1/4	I.D. 13	150	42.0	9.0	17
131049	MSN2393804	G 3/8	I.D. 4	150	40.0	9.0	19
131050	MSN2393806	G 3/8	I.D. 6	150	40.0	9.0	19
131052	MSN2393808	G 3/8	I.D. 8	150	40.0	9.0	19
131054	MSN2393809	G 3/8	I.D. 9	150	40.0	9.0	19
131055	MSN2393810	G 3/8	I.D. 10	150	42.0	9.0	19
134001	MSN2393812	G 3/8	I.D. 12	150	42.0	9.0	19
131056	MSN2393813	G 3/8	I.D. 13	150	42.0	9.0	19
131057	MSN2391206	G 1/2	I.D. 6	150	43.0	11.0	24

Male hose fittings

nickel-plated brass

PLUS

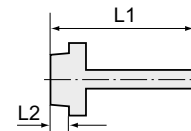

Male hose fitting with parallel male thread

Art. No.	Type No.	Thread	For hose mm	Max. operating temperature °C	L1 mm	L2 mm	a/f mm
131058	MSN2391208	G 1/2	I.D. 8	150	43.0	11.0	24
131059	MSN2391209	G 1/2	I.D. 9	150	43.0	11.0	24
131060	MSN2391210	G 1/2	I.D. 10	150	45.0	11.0	24
134004	MSN2391212	G 1/2	I.D. 12	150	45.0	11.0	24
131061	MSN2391213	G 1/2	I.D. 13	150	45.0	11.0	24
131062	MSN2391216	G 1/2	I.D. 16	150	49.0	11.0	24
131063	MSN2391219	G 1/2	I.D. 19	150	49.0	11.0	24
131064	MSN2393409	G 3/4	I.D. 9	150	44.0	12.0	32
131065	MSN2393413	G 3/4	I.D. 13	150	46.0	12.0	32
131066	MSN2393416	G 3/4	I.D. 16	150	50.0	12.0	32
131067	MSN2393419	G 3/4	I.D. 19	150	50.0	12.0	32
131068	MSN2393425	G 3/4	I.D. 25	150	57.0	12.0	32
131069	MSN239119	G 1	I.D. 19	150	51.0	13.0	38
131072	MSN239125	G 1	I.D. 25	150	58.0	13.0	38
131073	MSN239132	G 1	I.D. 32	150	58.0	13.0	38
131074	MSN23911432	G 1 1/4	I.D. 32	150	60.0	14.0	50
131075	MSN23911438	G 1 1/4	I.D. 38	150	67.0	14.0	50
131076	MSN23911232	G 1 1/2	I.D. 32	150	62.0	15.0	55
131077	MSN23911238	G 1 1/2	I.D. 38	150	69.0	15.0	55
131078	MSN23911250	G 1 1/2	I.D. 50	150	69.0	15.0	55
131079	MSN239250	G 2	I.D. 50	150	74.0	20.0	70
134007	MSN23921263	G 2 1/2	I.D. 63	150	87.0	23.0	80
134008	MSN239376	G 3	I.D. 76	150	91.0	26.0	95

Male hose fitting with metric male thread

Art. No.	Type No.	Thread	For hose mm	Max. operating temperature °C	L1 mm	L2 mm	a/f mm
135338	MSN239M302	M3	I.D. 2	150	14.0	3.0	5
135339	MSN239M303	M3	I.D. 3	150	14.0	3.0	5
135340	MSN239M503	M5	I.D. 3	150	16.0	5.0	7
135341	MSN239M504	M5	I.D. 4	150	16.0	5.0	7
135342	MSN239M506	M5	I.D. 6	150	20.0	5.0	7
135343	MSN239M806	M8x0.75	I.D. 6	150	22.0	7.0	12
135344	MSN239M1009	M10x1	I.D. 9	150	29.0	9.0	14
135345	MSN239M1213	M12x1.5	I.D. 13	150	42.0	9.0	17
135346	MSN239M1413	M14x1.5	I.D. 13	150	42.0	9.0	17



MSN239M504

Male hose fitting with conical male thread

Art. No.	Type No.	Thread	For hose mm	Max. operating temperature °C	L1 mm	L2 mm	a/f mm
134184	MSN239R1804	R 1/8	I.D. 4	150	38.0	8.0	14
134185	MSN239R1806	R 1/8	I.D. 6	150	38.0	8.0	14
134186	MSN239R1808	R 1/8	I.D. 8	150	38.0	8.0	14
134187	MSN239R1809	R 1/8	I.D. 9	150	38.0	8.0	14
134188	MSN239R1810	R 1/8	I.D. 10	150	40.0	8.0	14
134189	MSN239R1404	R 1/4	I.D. 4	150	42.0	11.0	17
134190	MSN239R1406	R 1/4	I.D. 6	150	42.0	11.0	17
134191	MSN239R1408	R 1/4	I.D. 8	150	42.0	11.0	17
134192	MSN239R1409	R 1/4	I.D. 9	150	42.0	11.0	17
134193	MSN239R1410	R 1/4	I.D. 10	150	44.0	11.0	17
134194	MSN239R1412	R 1/4	I.D. 12	150	44.0	11.0	17
134195	MSN239R1413	R 1/4	I.D. 13	150	44.0	11.0	17
134196	MSN239R3804	R 3/8	I.D. 4	150	42.0	11.0	19
134197	MSN239R3806	R 3/8	I.D. 6	150	42.0	11.0	19
134198	MSN239R3808	R 3/8	I.D. 8	150	42.0	11.0	19



MSN239R1404



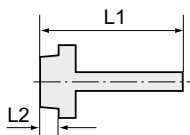

Male hose fittings

nickel-plated brass

PLUS



MSN239R1404

Male hose fitting with conical male thread

Art. No.	Type No.	Thread	For hose mm	Max. operating temperature °C	L1 mm	L2 mm	a/f mm
134199	MSN239R3809	R 3/8	I.D. 9	150	42.0	11.0	19
134200	MSN239R3810	R 3/8	I.D. 10	150	44.0	11.0	19
134201	MSN239R3812	R 3/8	I.D. 12	150	44.0	11.0	19
134202	MSN239R3813	R 3/8	I.D. 13	150	44.0	11.0	19
134203	MSN239R1206	R 1/2	I.D. 6	150	46.0	14.0	24
134204	MSN239R1208	R 1/2	I.D. 8	150	46.0	14.0	24
134205	MSN239R1209	R 1/2	I.D. 9	150	46.0	14.0	24
134206	MSN239R1210	R 1/2	I.D. 10	150	48.0	14.0	24
134207	MSN239R1212	R 1/2	I.D. 12	150	48.0	14.0	24
134208	MSN239R1213	R 1/2	I.D. 13	150	48.0	14.0	24
134209	MSN239R1216	R 1/2	I.D. 16	150	52.0	14.0	24
134210	MSN239R1219	R 1/2	I.D. 19	150	52.0	14.0	24
134211	MSN239R3409	R 3/4	I.D. 9	150	48.0	16.0	32
134212	MSN239R3413	R 3/4	I.D. 13	150	50.0	16.0	32
134213	MSN239R3416	R 3/4	I.D. 16	150	54.0	16.0	32
134214	MSN239R3419	R 3/4	I.D. 19	150	54.0	16.0	32
134215	MSN239R3425	R 3/4	I.D. 25	150	61.0	16.0	32
134216	MSN239R119	R 1	I.D. 19	150	56.0	18.0	36
134217	MSN239R125	R 1	I.D. 25	150	63.0	18.0	36
134218	MSN239R132	R 1	I.D. 32	150	63.0	18.0	36
134219	MSN239R11432	R 1 1/4	I.D. 32	150	66.0	20.0	44
134220	MSN239R11438	R 1 1/4	I.D. 38	150	73.0	20.0	44
134221	MSN239R11232	R 1 1/2	I.D. 32	150	72.0	20.0	55
134222	MSN239R11238	R 1 1/2	I.D. 38	150	74.0	20.0	55
134223	MSN239R11250	R 1 1/2	I.D. 50	150	74.0	20.0	55
134224	MSN239R250	R 2	I.D. 50	150	79.0	25.0	70

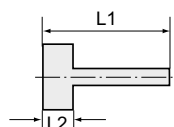

Female stems

nickel-plated brass

PLUS



MSN239A1404

Female stem with parallel female thread

Art. No.	Type No.	Thread	For hose mm	Max. operating temperature °C	L1 mm	L2 mm	a/f mm
134876	MSN239A1804	G 1/8	I.D. 4	150	36.0	10.0	14
134877	MSN239A1806	G 1/8	I.D. 6	150	36.0	10.0	14
134878	MSN239A1808	G 1/8	I.D. 8	150	36.0	10.0	14
134879	MSN239A1809	G 1/8	I.D. 9	150	36.0	10.0	14
134880	MSN239A1810	G 1/8	I.D. 10	150	38.0	10.0	14
134881	MSN239A1404	G 1/4	I.D. 4	150	37.0	11.0	17
134882	MSN239A1406	G 1/4	I.D. 6	150	37.0	11.0	17
134883	MSN239A1408	G 1/4	I.D. 8	150	37.0	11.0	17
134884	MSN239A1409	G 1/4	I.D. 9	150	37.0	11.0	17
134885	MSN239A1410	G 1/4	I.D. 10	150	39.0	11.0	17
134886	MSN239A1412	G 1/4	I.D. 12	150	39.0	11.0	17
134887	MSN239A1413	G 1/4	I.D. 13	150	39.0	11.0	17
134888	MSN239A3804	G 3/8	I.D. 4	150	37.0	11.0	19
134889	MSN239A3806	G 3/8	I.D. 6	150	37.0	11.0	19
134890	MSN239A3808	G 3/8	I.D. 8	150	37.0	11.0	19
134891	MSN239A3809	G 3/8	I.D. 9	150	37.0	11.0	19
134892	MSN239A3810	G 3/8	I.D. 10	150	39.0	11.0	19
134893	MSN239A3812	G 3/8	I.D. 12	150	39.0	11.0	19

Female stems

nickel-plated brass

PLUS

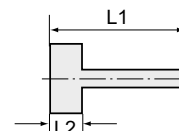

Female stem with parallel female thread

Art. No.	Type No.	Thread	For hose mm	Max. operating temperature °C	L1 mm	L2 mm	a/f mm
134894	MSN239A3813	G 3/8	I.D. 13	150	39.0	11.0	19
134896	MSN239A1206	G 1/2	I.D. 6	150	40.5	14.5	24
134897	MSN239A1208	G 1/2	I.D. 8	150	40.5	14.5	24
134898	MSN239A1209	G 1/2	I.D. 9	150	40.5	14.5	24
134899	MSN239A1210	G 1/2	I.D. 10	150	42.5	14.5	24
134900	MSN239A1212	G 1/2	I.D. 12	150	42.5	14.5	24
134901	MSN239A1213	G 1/2	I.D. 13	150	42.5	14.5	24
134903	MSN239A1216	G 1/2	I.D. 16	150	46.5	14.5	24
134904	MSN239A1219	G 1/2	I.D. 19	150	46.5	14.5	24
134905	MSN239A3409	G 3/4	I.D. 9	150	43.0	17.0	32
134906	MSN239A3413	G 3/4	I.D. 13	150	45.0	17.0	32
134907	MSN239A3416	G 3/4	I.D. 16	150	49.0	17.0	32
134908	MSN239A3419	G 3/4	I.D. 19	150	49.0	17.0	32
134909	MSN239A3425	G 3/4	I.D. 25	150	56.0	17.0	32
134910	MSN239A119	G 1	I.D. 19	150	51.5	19.5	38
134911	MSN239A125	G 1	I.D. 25	150	58.5	19.5	38
134912	MSN239A132	G 1	I.D. 32	150	58.5	19.5	38
134913	MSN239A11432	G 1 1/4	I.D. 32	150	60.0	21.0	50
134914	MSN239A11438	G 1 1/4	I.D. 38	150	67.0	21.0	50
134915	MSN239A11232	G 1 1/2	I.D. 32	150	60.0	21.0	55
134916	MSN239A11238	G 1 1/2	I.D. 38	150	67.0	21.0	55
134917	MSN239A11250	G 1 1/2	I.D. 50	150	67.0	21.0	55
134918	MSN239A250	G 2	I.D. 50	150	74.0	28.0	70

Extensions

nickel-plated brass

PLUS

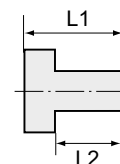

Extension, short

Art. No.	Type No.	Male thread	Female thread	Max. operating temperature °C	L1 mm	L2 mm	a/f mm
111502	230.01-N	M5	G 1/8	150	17.0	4.0	12
111503	230.02-N	G 1/8	G 1/8	150	18.5	6.0	14
111504	230.03-N	G 1/8	G 1/4	150	21.5	6.0	17
111505	230.04-N	G 1/4	G 1/4	150	22.5	8.0	17
111506	230.05-N	G 1/4	G 3/8	150	26.0	8.0	22
111507	230.06-N	G 3/8	G 3/8	150	26.5	9.0	22
111508	230.07-N	G 3/8	G 1/2	150	29.5	9.0	24
111509	230.08-N	G 1/2	G 1/2	150	29.5	10.0	25



230.04-N

Extension, short, conical male thread, parallel female thread

Art. No.	Type No.	Male thread	Female thread	Max. operating temperature °C	L1 mm	L2 mm	a/f mm
111510	1230.02-N	R 1/8	G 1/8	150	20.0	8.0	14
111511	1230.03-N	R 1/8	G 1/4	150	22.5	8.0	17
111512	1230.09-N	R 1/8	G 3/8	150	21.5	8.0	22
111513	1230.04-N	R 1/4	G 1/4	150	25.0	11.0	17
111514	1230.05-N	R 1/4	G 3/8	150	28.5	11.0	22
111515	1230.06-N	R 1/4	G 1/2	150	29.0	11.0	24
111516	1230.07-N	R 3/8	G 3/8	150	28.5	11.5	22
111517	1230.08-N	R 3/8	G 1/2	150	32.0	11.5	24
111518	1230.10-N	R 1/2	G 1/2	150	34.0	14.0	24
111519	1230.11-N	R 1/2	G 3/4	150	35.0	14.0	32



1230.04-N

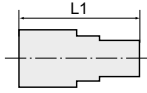

Extensions

nickel-plated brass

PLUS



234.06-N

Extension, long, parallel

Art. No.	Type No.	Male thread	Female thread	Max. operating temperature °C	L1 mm	a/f mm
111529	234.01-N	G 1/8	G 1/8	150	22.0	14
111530	234.02-N	G 1/8	G 1/8	150	42.0	14
111531	234.03-N	G 1/8	G 1/8	150	51.0	14
111532	234.04-N	G 1/8	G 1/8	150	100.0	14
111533	234.05-N	G 1/4	G 1/4	150	35.0	17
111534	234.06-N	G 1/4	G 1/4	150	51.0	17
111535	234.07-N	G 1/4	G 1/4	150	100.0	17

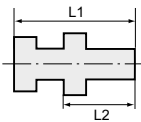

Bulkhead connectors

nickel-plated brass

PLUS



MSN2321418

Bulkhead connector

Art. No.	Type No.	Male thread	Female thread	Max. operating temperature °C	L1 mm	L2 mm	a/f 1 mm	a/f 2 mm
138492	MSN232M1618	M16x1.5	G 1/8	150	24.0	19.0	17	22
138493	MSN232M2014	M20x1.5	G 1/4	150	29.0	23.0	22	27
138494	MSN232M2638	M26x1.5	G 3/8	150	28.0	22.0	27	32
138495	MSN232M2812	M28x1.5	G 1/2	150	30.0	24.0	30	36
136678	MSN232M3434	M34x2	G 3/4	150	31.0	25.0	38	41
136679	MSN232M421	M42x2	G 1	150	34.0	27.0	45	50
136680	MSN232M49114	M49x2	G 1 1/4	150	39.0	31.0	55	60
136681	MSN232M54112	M54x2	G 1 1/2	150	46.0	38.0	60	65
136682	MSN23218M5	G 1/8	M5	150	16.0	12.0	12	14
136683	MSN2321418	G 1/4	G 1/8	150	16.0	14.0	17	17
136684	MSN2323814	G 3/8	G 1/4	150	22.0	17.0	19	19
136685	MSN2321238	G 1/2	G 3/8	150	27.0	21.0	24	24
136686	MSN2323412	G 3/4	G 1/2	150	27.0	21.0	30	32
136687	MSN232134	G 1	G 3/4	150	31.0	25.0	38	41

Hose fittings

nickel-plated brass

PLUS

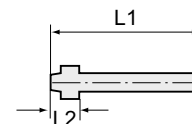

MSN2361806

Hose fitting with ball nipple						
Art. No.	Type No.	For hose mm	For swivel nut type no.	Max. operating temperature °C	L1 mm	L2 mm
136654	MSN2361804	I.D. 4	MSN2341846	150	37.0	6.0
136655	MSN2361806	I.D. 6	MSN2341846	150	37.0	6.0
136656	MSN2361404	I.D. 4	MSN2341446	150	37.5	6.5
136657	MSN2361406	I.D. 6	MSN2341446	150	36.5	6.5
136658	MSN2361409	I.D. 9	MSN2341409	150	37.5	6.5
136659	MSN2363804	I.D. 4	MSN23438469	150	35.0	8.0
136660	MSN2363806	I.D. 6	MSN23438469	150	39.0	8.0
136661	MSN2363809	I.D. 9	MSN23438469	150	39.0	8.0
136662	MSN2361206	I.D. 6	MSN2341269	150	39.0	8.0
136663	MSN2361208	I.D. 8	MSN2341269	150	39.0	8.0
136664	MSN2361209	I.D. 9	MSN2341269	150	39.0	8.0
136665	MSN2361210	I.D. 10	MSN2341213	150	41.0	8.0
136666	MSN2361212	I.D. 12	MSN2341213	150	41.0	8.0
136667	MSN2361213	I.D. 13	MSN2341213	150	41.0	8.0
136668	MSN2363413	I.D. 13	MSN2343419	150	42.0	9.0
136669	MSN2363419	I.D. 19	MSN2343419	150	46.0	9.0
136670	MSN236119	I.D. 19	MSN234119	150	47.0	10.0
136671	MSN236125	I.D. 25	MSN234125	150	54.0	10.0

Caps

nickel-plated brass

PLUS

Hexagonal cap					
Art. No.	Type No.	Thread	Max. operating temperature °C	L1 mm	a/f mm
138496	MSNVK18	G 1/8	150	10.0	13
138497	MSNVK14	G 1/4	150	10.0	16
138498	MSNVK38	G 3/8	150	10.0	19
138499	MSNVK12	G 1/2	150	12.0	23
138500	MSNVK34	G 3/4	150	14.0	29
138501	MSNVK1	G 1	150	15.0	36
136688	MSNVK114	G 1 1/4	150	17.0	47
136689	MSNVK112	G 1 1/2	150	20.0	53
136690	MSNVK2	G 2	150	20.0	64
136691	MSNVK212	G 2 1/2	150	20.0	85
136692	MSNVK3	G 3	150	20.0	95



MSNVK14



Swivel nuts

nickel-plated brass

PLUS

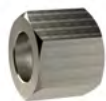

MSN2341446

Hexagonal swivel nut

Art. No.	Type No.	Thread	For fitting type no.	Max. operating temperature °C	L1 mm	a/f mm
138488	MSN2341846	G 1/8	MSN2361804 + MSN2361806	150	13.0	14
138489	MSN2341446	G 1/4	MSN2361404 + MSN2361406	150	15.0	17
138490	MSN2341409	G 1/4	MSN2361409	150	15.0	17
138491	MSN23438469	G 3/8	MSN2363804 + MSN2363806 + MSN2363809	150	15.0	19
136672	MSN2341269	G 1/2	MSN2361206 + MSN2361208 + MSN2361209	150	18.0	24
136673	MSN2341213	G 1/2	MSN2361210 + MSN2361212 + MSN2361213	150	18.0	24
136675	MSN2343419	G 3/4	MSN2363419	150	18.0	32
136676	MSN234119	G 1	MSN236119	150	21.0	38
136677	MSN234125	G 1	MSN236125	150	21.0	38

Lock nuts

nickel-plated brass

PLUS



MSN23814

Hexagonal lock nut

Art. No.	Type No.	Thread	Max. operating temperature °C	L1 mm	a/f mm
138502	MSN23818	G 1/8	150	3.5	14
138503	MSN23814	G 1/4	150	3.5	17
138504	MSN23838	G 3/8	150	4.5	19
138505	MSN23812	G 1/2	150	5.0	24
138506	MSN23834	G 3/4	150	5.0	32
138507	MSN2381	G 1	150	6.0	41
136693	MSN238114	G 1 1/4	150	8.5	50
136694	MSN238112	G 1 1/2	150	9.0	58
136695	MSN2382	G 2	150	11.0	70
136696	MSN238M10	M10x1.0	150	3.5	14
136697	MSN238M12	M12x1.0	150	5.0	17
136698	MSN238M14	M14x1.0	150	5.0	19
136699	MSN238M16	M16x1.0	150	5.0	22
136700	MSN238M20	M20x1.5	150	6.0	27
136701	MSN238M22	M22x1.0	150	5.0	27
136702	MSN238M28	M28x1.5	150	6.0	38
136703	MSN238M24	M24x2	150	6.0	28
136704	MSN238M42	M42x2	150	7.0	50
136705	MSN238M49	M49x2	150	8.0	60
136706	MSN238M54	M54x2	150	9.0	65

Double pipe nipples

stainless steel 1.4571

Material	Stainless steel 1.4571
Max. working pressure	40 bar
Standard thread	R thread acc. to EN 10226

Double pipe nipple, stainless steel 1.4571

Art. No.	Type No.	Thread	Length mm
111556	LN 1440-ES	R 1/4	40.0
111557	LN 1460-ES	R 1/4	60.0
111558	LN 1480-ES	R 1/4	80.0
111559	LN 14100-ES	R 1/4	100.0
111560	LN 14120-ES	R 1/4	120.0
111561	LN 14150-ES	R 1/4	150.0
111562	LN 14180-ES	R 1/4	180.0
111563	LN 14200-ES	R 1/4	200.0
111564	LN 3840-ES	R 3/8	40.0
111565	LN 3860-ES	R 3/8	60.0
111566	LN 3880-ES	R 3/8	80.0
111567	LN 38100-ES	R 3/8	100.0
111568	LN 38120-ES	R 3/8	120.0
111569	LN 38150-ES	R 3/8	150.0
111570	LN 38180-ES	R 3/8	180.0
111571	LN 38200-ES	R 3/8	200.0
111572	LN 1240-ES	R 1/2	40.0
111573	LN 1260-ES	R 1/2	60.0
111574	LN 1280-ES	R 1/2	80.0
111575	LN 12100-ES	R 1/2	100.0
111576	LN 12120-ES	R 1/2	120.0
111577	LN 12150-ES	R 1/2	150.0
111578	LN 12180-ES	R 1/2	180.0
111579	LN 12200-ES	R 1/2	200.0
111580	LN 3440-ES	R 3/4	40.0
111581	LN 3460-ES	R 3/4	60.0
111582	LN 3480-ES	R 3/4	80.0
111583	LN 34100-ES	R 3/4	100.0
111584	LN 34120-ES	R 3/4	120.0
111585	LN 34150-ES	R 3/4	150.0
111586	LN 34180-ES	R 3/4	180.0
111587	LN 34200-ES	R 3/4	200.0
111588	LN 1040-ES	R 1	40.0
111589	LN 1060-ES	R 1	60.0
111590	LN 1080-ES	R 1	80.0
111591	LN 10100-ES	R 1	100.0
111592	LN 10120-ES	R 1	120.0
111593	LN 10150-ES	R 1	150.0
111594	LN 10180-ES	R 1	180.0
111595	LN 10200-ES	R 1	200.0
111596	LN 11440-ES	R 1 1/4	40.0
111597	LN 11460-ES	R 1 1/4	60.0
111598	LN 11480-ES	R 1 1/4	80.0
111599	LN 114100-ES	R 1 1/4	100.0
111600	LN 114120-ES	R 1 1/4	120.0
111601	LN 114150-ES	R 1 1/4	150.0
111602	LN 114180-ES	R 1 1/4	180.0
111603	LN 114200-ES	R 1 1/4	200.0



LN 1280-ES



Double pipe nipples

stainless steel 1.4571



LN 1280-ES

Double pipe nipple, stainless steel 1.4571

Art. No.	Type No.	Thread	Length mm
111604	LN 11240-ES	R 1 1/2	40.0
111605	LN 11260-ES	R 1 1/2	60.0
111606	LN 11280-ES	R 1 1/2	80.0
111607	LN 112100-ES	R 1 1/2	100.0
111608	LN 112120-ES	R 1 1/2	120.0
111609	LN 112150-ES	R 1 1/2	150.0
111610	LN 112180-ES	R 1 1/2	180.0
111611	LN 112200-ES	R 1 1/2	200.0
111612	LN 2040-ES	R 2	40.0
111613	LN 2060-ES	R 2	60.0
111614	LN 2080-ES	R 2	80.0
111615	LN 20100-ES	R 2	100.0
111616	LN 20120-ES	R 2	120.0
111617	LN 20150-ES	R 2	150.0
111618	LN 20180-ES	R 2	180.0
111619	LN 20200-ES	R 2	200.0

Standard screw fittings

stainless steel 1.4571

Max. working pressure	60 bar
Max. operating temperature	150 °C
Material	Stainless steel 1.4571

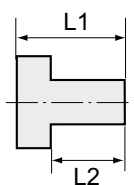

Reducing nipples

stainless steel 1.4571



251.02-ES

Reducing nipple, short type

Art. No.	Type No.	Male thread	Female thread	L1 mm	L2 mm	a/f mm
111620	251.00-ES	G 1/8	M5	11.0	7.0	14
111621	251.00/S-ES	G 1/4	M5	14.0	10.0	17
111622	251.01-ES	G 1/4	G 1/8	13.0	8.0	17
111623	251.06-ES	G 3/8	G 1/8	13.0	9.5	19
111624	251.02-ES	G 3/8	G 1/4	13.0	9.5	19
111625	251.08-ES	G 1/2	G 1/8	18.0	12.0	24
111626	251.07-ES	G 1/2	G 1/4	15.5	11.5	22
111627	251.03-ES	G 1/2	G 3/8	15.5	11.5	22
111628	251.09-ES	G 3/4	G 3/8	18.0	12.0	32
111629	251.04-ES	G 3/4	G 1/2	21.0	14.0	32
111630	251.10-ES	G 1	G 1/2	24.0	16.0	36
111631	251.05-ES	G 1	G 3/4	18.0	12.0	36

Reducing nipples

stainless steel 1.4571

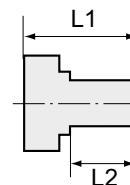

Reducing nipple, long type						
Art. No.	Type No.	Male thread	Female thread	L1 mm	L2 mm	a/f mm
111632	252.08/1-ES	M5	M5	16.0	5.5	10
111633	252.08/2-ES	M5	G 1/8	17.0	5.0	14
111634	252.11-ES	G 1/8	G 1/8	23.0	8.0	14
111635	252.08-ES	G 1/8	G 1/4	26.0	10.0	17
111636	252.12-ES	G 1/4	G 1/8	28.0	10.0	17
111637	252.13-ES	G 1/4	G 1/4	28.0	10.0	17
111638	252.09-ES	G 1/4	G 3/8	26.0	10.0	19
111639	252.14-ES	G 3/8	G 1/4	29.0	10.0	19
111640	252.15-ES	G 3/8	G 3/8	29.0	10.0	19
111641	252.10-ES	G 3/8	G 1/2	27.0	12.0	24
111642	252.16-ES	G 1/2	G 3/8	34.0	12.0	24
111643	252.17-ES	G 1/2	G 1/2	34.0	12.0	24
111644	252.18-ES	G 1/2	G 3/4	38.0	13.0	32



252.16-ES



252.10-ES



252.18-ES

Screw plugs

stainless steel 1.4571

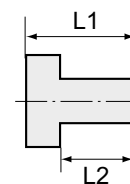

Hexagon socket screw plug with collar					
Art. No.	Type No.	Thread	L1 mm	L2 mm	a/f mm
111645	252.91-ES	G 1/8 hexagon socket head	11.0	8.0	5
111646	252.92-ES	G 1/4 hexagon socket head	13.0	10.0	6
111647	252.93-ES	G 3/8 hexagon socket head	15.0	12.0	8
111648	252.94-ES	G 1/2 hexagon socket head	18.0	14.0	10
111649	252.94-2ES	G 3/4 hexagon socket head	20.0	16.0	12
111650	252.94-3ES	G 1 hexagon socket head	21.0	16.0	17



252.92-ES

Hexagon socket screw plug without collar					
Art. No.	Type No.	Thread	L1 mm	a/f mm	
111651	252.101-ES	G 1/8 hexagon socket head	8.0	5	
111652	252.102-ES	G 1/4 hexagon socket head	10.0	6	
111653	252.103-ES	G 3/8 hexagon socket head	12.5	8	
111654	252.104-ES	G 1/2 hexagon socket head	14.0	10	



252.102-ES

Hexagon socket screw plug without collar					
Art. No.	Type No.	Thread	L1 mm	a/f mm	
111655	253.101-ES	R 1/8 hexagon socket head	8.0	5	
111656	253.102-ES	R 1/4 hexagon socket head	10.0	7	
111657	253.103-ES	R 3/8 hexagon socket head	10.0	8	
111658	253.104-ES	R 1/2 hexagon socket head	10.0	10	
111659	253.105-ES	R 3/4 hexagon socket head	12.0	12	
111660	253.106-ES	R 1 hexagon socket head	12.0	17	



253.102-ES



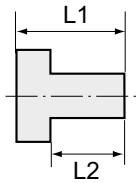

Screw plugs

stainless steel 1.4571



252.96-ES



252.112-ES

Hexagon head screw plug

Art. No.	Type No.	Thread	L1 mm	L2 mm	a/f mm
111661	252.95-ES	G 1/8 hexagon head	11.0	6.0	13
111662	252.96-ES	G 1/4 hexagon head	13.0	8.0	17
111663	252.97-ES	G 3/8 hexagon head	14.0	8.0	19
111664	252.98-ES	G 1/2 hexagon head	16.0	10.0	24
111665	252.99-ES	G 3/4 hexagon head	16.0	11.0	30
111666	252.100-ES	G 1 hexagon head	19.0	13.0	38

Hexagon head screw plug with collar

Art. No.	Type No.	Thread	L1 mm	L2 mm	a/f mm
111667	252.110-ES	G 1/8 hexagon head	17.0	8.0	10
111668	252.111-ES	G 1/4 hexagon head	21.0	12.0	13
111669	252.112-ES	G 3/8 hexagon head	21.0	12.0	17
111670	252.113-ES	G 1/2 hexagon head	26.0	14.0	19
111671	252.114-ES	G 3/4 hexagon head	30.0	16.0	24
111672	252.115-ES	G 1 hexagon head	32.0	16.0	27

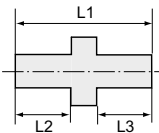

Double nipples

stainless steel 1.4571



252.05-ES

Double nipple, male thread

Art. No.	Type No.	Thread 1	Thread 2	L1 mm	L2 mm	L3 mm	a/f mm
111673	252 C-ES	M5	M5	13.0	5.0	5.0	7
111674	252 D-ES	M5	G 1/8	17.0	5.0	7.0	14
111675	252 E-ES	M5	G 1/4	21.0	7.0	9.0	17
111676	252 A-ES	G 1/8	G 1/8	21.0	8.0	8.0	14
111677	252 B-ES	G 1/4	G 1/8	22.0	9.0	8.0	17
111678	252 B/1-ES	G 1/8	G 3/8	25.0	9.0	11.0	19
111679	252.01-ES	G 1/4	G 1/4	23.0	9.0	9.0	17
111680	252.02-ES	G 1/4	G 3/8	24.0	9.0	10.0	19
111681	252.02/S-ES	G 1/4	G 1/2	29.0	11.0	12.0	24
111682	252.03-ES	G 3/8	G 3/8	25.0	10.0	10.0	19
111683	252.04-ES	G 3/8	G 1/2	27.0	10.0	12.0	24
111684	252.04/S-ES	G 3/8	G 3/4	36.0	12.0	16.0	32
111685	252.05-ES	G 1/2	G 1/2	29.0	12.0	12.0	24
111686	252.06-ES	G 3/4	G 1/2	33.0	12.0	12.0	32
111687	252.06/S-ES	G 1/2	G 1	40.0	16.0	16.0	36
111688	252.07-ES	G 3/4	G 3/4	33.0	12.0	12.0	32
111689	252.07/1-ES	G 3/4	G 1	40.0	16.0	16.0	36
111690	252.07/2-ES	G 1	G 1	42.5	17.0	17.0	36

Double nipple, conical male thread, acc. to ISO 7-1

Art. No.	Type No.	Thread 1	Thread 2	L1 mm	L2 mm	L3 mm	a/f mm
125690	252.400-ES	R 1/8	R 1/8	21.0	8.0	8.0	10
125691	252.400/2-ES	R 1/8	R 1/4	24.0	8.0	11.0	14
125692	252.400/3-ES	R 1/8	R 3/8	24.0	8.0	11.0	17
111694	252.301-ES	R 1/4	R 1/4	30.0	12.0	12.0	14
125693	252.401/2-ES	R 1/4	R 3/8	27.0	11.0	11.0	17

Double nipples

stainless steel 1.4571

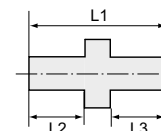

252.303-ES

Double nipple, conical male thread, acc. to ISO 7-1							
Art. No.	Type No.	Thread 1	Thread 2	L1 mm	L2 mm	L3 mm	a/f mm
125694	252.401/4-ES	R 1/4	R 1/2	31.0	11.0	14.0	22
111697	252.302-ES	R 3/8	R 3/8	38.0	16.0	16.0	22
125695	252.402/2-ES	R 3/8	R 1/2	31.0	11.0	14.0	22
125696	252.402/4-ES	R 3/8	R 1	35.0	11.0	18.0	36
111700	252.303-ES	R 1/2	R 1/2	38.0	16.0	16.0	27
125697	252.403/2-ES	R 1/2	R 3/4	36.0	14.0	16.0	28
125698	252.403/3-ES	R 1/2	R 1	38.0	14.0	18.0	36
111703	252.304-ES	R 3/4	R 3/4	51.5	22.0	22.0	32
125699	252.404/2-ES	R 3/4	R 1	40.0	16.0	18.0	36
125700	252.404/3-ES	R 3/4	R 1 1/4	43.0	16.0	20.0	42
125701	252.404/4-ES	R 3/4	R 1 1/2	44.0	16.0	20.0	50
111707	252.305-ES	R 1	R 1	47.0	19.5	19.5	41
125702	252.405/2-ES	R 1	R 1 1/4	45.0	18.0	20.0	42
125703	252.405/3-ES	R 1	R 1 1/2	46.0	18.0	20.0	50
125704	252.405/4-ES	R 1	R 2	50.0	18.0	24.0	62
125705	252.406-ES	R 1 1/4	R 1 1/4	47.0	20.0	20.0	42
125706	252.406/2-ES	R 1 1/4	R 1 1/2	48.0	20.0	20.0	50
125707	252.406/3-ES	R 1 1/4	R 2	53.0	20.0	25.0	62
125708	252.407-ES	R 1 1/2	R 1 1/2	48.0	20.0	20.0	50
125709	252.407/2-ES	R 1 1/2	R 2	53.0	20.0	25.0	60
125710	252.408-ES	R 2	R 2	58.0	25.0	25.0	60
125711	252.408/2-ES	R 2	R 2 1/2	63.0	25.0	28.0	78
125712	252.408/3-ES	R 2	R 3	66.0	25.0	31.0	90
125713	252.409-ES	R 2 1/2	R 2 1/2	66.0	28.0	28.0	78
125714	252.409/2-ES	R 2 1/2	R 3	69.0	28.0	31.0	90
125715	252.410-ES	R 3	R 3	72.0	31.0	31.0	90

Bulkhead connectors

stainless steel 1.4571

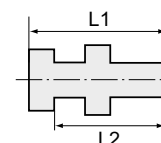

252.42-ES

Bulkhead connector							
Art. No.	Type No.	Male thread	Female thread	L1 mm	L2 mm	a/f 1 mm	a/f 2 mm
111722	252.41-ES	G 1/4	G 1/8	18.0	14.0	17	17
111723	252.42-ES	G 3/8	G 1/4	22.0	17.0	19	24
111724	252.43-ES	G 1/2	G 3/8	27.0	21.0	24	24



Swivel nuts

stainless steel 1.4571



234 B-ES

Hexagonal swivel nut

Art. No.	Type No.	Thread	For fitting type no.	L1 mm	a/f mm
111725	234 A-ES	G 1/4	I.D. 4, I.D. 6	15.0	17
111726	234 A/S-ES	G 1/4	I.D. 9	15.0	17
111727	234 B-ES	G 3/8	I.D. 4, I.D. 6, I.D. 9	15.0	19
111728	234 C-ES	G 1/2	I.D. 9	16.0	24
111729	234 C/S-ES	G 1/2	I.D. 13	16.0	24
111730	234 C/L-ES	G 1/2	I.D. 6, I.D. 9, I.D. 13	20.0	24
111731	234 C/M-ES	G 3/4	I.D. 13, I.D. 19	16.0	32
111732	234 C/N-ES	G 1	I.D. 19, I.D. 25	18.0	41

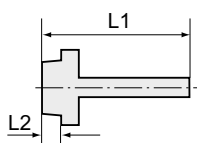

Hose fittings

stainless steel 1.4571



239 E-ES

Male hose fitting with male thread

Art. No.	Type No.	Thread	For hose mm	L1 mm	L2 mm	a/f mm
111733	239.00-ES	M5	I.D. 4	15.5	5.0	8
111734	N239.00-ES1	M5	I.D. 6	23.5	5.0	9
111735	239.01-ES	G 1/8	I.D. 4	41.5	9.0	14
111736	239.02-ES	G 1/8	I.D. 6	41.5	9.0	14
111737	N239.02-ES1	G 1/8	I.D. 8	36.0	7.0	14
111738	239.03-ES	G 1/8	I.D. 9	48.5	10.0	17
111739	239 A-ES	G 1/4	I.D. 4	48.5	10.0	17
111740	239 B-ES	G 1/4	I.D. 6	48.5	10.0	17
111741	N239 B-ES1	G 1/4	I.D. 8	39.0	9.0	17
111742	239 C-ES	G 1/4	I.D. 9	48.5	10.0	17
111743	N239 C-ES1	G 1/4	I.D. 10	39.0	9.0	17
111744	239 C/S-ES	G 1/4	I.D. 13	48.5	10.0	19
111745	239 D-ES	G 3/8	I.D. 4	48.5	10.0	19
111746	239 E-ES	G 3/8	I.D. 6	48.5	10.0	19
111747	N239 E-ES1	G 3/8	I.D. 8	39.0	9.0	19
111748	239 F-ES	G 3/8	I.D. 9	48.5	10.0	19
111749	N239 F-ES1	G 3/8	I.D. 10	39.0	9.0	19
111750	239 F/S-ES	G 3/8	I.D. 13	48.5	10.0	19
111751	239 G-ES	G 1/2	I.D. 6	48.5	10.0	24
111752	N239 G-ES1	G 1/2	I.D. 8	42.0	11.0	24
111753	239 H-ES	G 1/2	I.D. 9	48.5	10.0	24
111754	N239 H-ES1	G 1/2	I.D. 10	42.0	11.0	24
111755	239 J-ES	G 1/2	I.D. 13	50.0	10.0	24
111756	N239 J-ES1	G 1/2	I.D. 16	53.0	11.0	24
111757	N239 J-ES2	G 1/2	I.D. 19	53.0	11.0	24
111758	239 K-ES	G 3/4	I.D. 9	50.5	11.0	27
111759	239 M-ES	G 3/4	I.D. 13	52.0	11.0	27
111760	239 P-ES	G 3/4	I.D. 19	50.5	11.0	27
111761	N239 S-ES	G 1	I.D. 19	55.0	13.0	38
111762	N239 W-ES	G 1	I.D. 25	55.0	13.0	38
111763	N239 Z-ES	G 1	I.D. 32	55.0	13.0	38

Hose fittings

stainless steel 1.4571

Male hose fitting with conical male thread

Art. No.	Type No.	Thread	For hose mm	L1 mm	L2 mm	a/f mm
111764	N239 C-ESR	R 1/4	I.D. 9	39.7	9.7	17
111765	N239 F-ESR	R 3/8	I.D. 9	40.1	10.1	19
111766	N239 FS-ESR	R 3/8	I.D. 13	43.1	10.1	19
111767	N239 J-ESR	R 1/2	I.D. 13	47.2	13.2	24
111768	N239 J-ESR2	R 1/2	I.D. 19	55.2	13.2	24
111769	N239 P-ESR	R 3/4	I.D. 19	56.2	14.5	32
111770	N239 W-ESR	R 1	I.D. 25	58.8	16.8	38

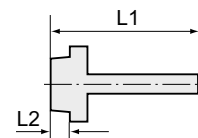

N239 F-ESR

Female hose fittings

stainless steel 1.4571

Female hose fitting with female thread

Art. No.	Type No.	Thread	For hose mm	L1 mm	L2 mm	a/f mm
111771	239.10-ES	G 1/8	I.D. 6	35.0	10.0	12
111772	239.11-ES	G 1/8	I.D. 8	35.0	10.0	12
111773	239.12-ES	G 1/4	I.D. 6	36.0	11.0	17
111774	239.13-ES	G 1/4	I.D. 8	36.0	11.0	17
111775	239.14-ES	G 1/4	I.D. 10	36.0	11.0	17
111776	239.15-ES	G 1/4	I.D. 13	40.5	11.0	17
111777	239.18-ES	G 3/8	I.D. 6	36.0	11.0	19
111778	239.19-ES	G 3/8	I.D. 8	36.0	11.0	19
111779	239.20-ES	G 3/8	I.D. 10	36.0	11.0	19
111780	239.21-ES	G 3/8	I.D. 13	40.5	11.0	19
111781	239.25-ES	G 1/2	I.D. 6	39.0	14.5	24
111782	239.26-ES	G 1/2	I.D. 8	39.0	14.5	24
111783	239.27-ES	G 1/2	I.D. 10	39.0	14.5	24
111784	239.28-ES	G 1/2	I.D. 13	44.0	14.5	24

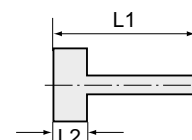

239.19-ES

Hose fittings

stainless steel 1.4571

Hose fitting with ball nipple

Art. No.	Type No.	For hose mm	For swivel nut type no.	L1 mm	L2 mm
111785	236.02-ES	I.D. 6	-	33.5	6.0
111786	236 A-ES	I.D. 4	234 A-ES	47.0	13.5
111787	236 B-ES	I.D. 6	234 A-ES	47.0	13.5
111788	236 C-ES	I.D. 9	234 A/S-ES	47.0	14.0
111789	236 E-ES	I.D. 6	234 B-ES	48.5	15.0
111790	236 F-ES	I.D. 9	234 B-ES	48.5	15.0
111791	236 H-ES	I.D. 9	234 C/L-ES	48.5	15.0
111792	236 J-ES	I.D. 13	234 C/S-ES	48.5	15.0

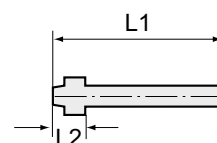

236 E-ES



Sockets

stainless steel 1.4571



252.22-ES

Socket with outer hex

Art. No.	Type No.	Thread	L1 mm	a/f mm
111793	252.20-ES	M5	11.0	8
111794	252.21-ES	G 1/8	22.0	14
111795	252.22-ES	G 1/4	26.0	17
111796	252.23-ES	G 3/8	26.0	22
111797	252.24-ES	G 1/2	30.0	27
111798	252.24/1-ES	G 3/4	36.0	32
111799	252.24/2-ES	G 1	40.0	41



252.32-ES

Reducing socket with hexagon head

Art. No.	Type No.	Thread 1	Thread 2	L1 mm	a/f mm
111800	252.31-ES	G 1/8	M5	12.6	14
111801	252.32-ES	G 1/4	G 1/8	19.5	17
111802	252.33-ES	G 3/8	G 1/4	22.8	22
111803	252.34-ES	G 1/2	G 3/8	24.0	27
111804	252.35-ES	G 3/4	G 1/2	25.0	32
111805	252.36-ES	G 1	G 3/4	25.0	41

Stainless steel fittings

stainless steel 1.4408

NEW Double nipples

stainless steel 1.4408

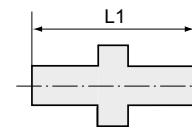

Material	Stainless steel 1.4408
Max. working pressure	20 bar
Max. operating temperature	150 °C



DGNG1ES4408

Double nipple, hexagonal, cylindrically, DIN EN ISO 228-1

Art. No.	Type No.	Thread	L1 mm	a/f mm
118874	DGNG18ES4408	G 1/8	29.5	12
118875	DGNG14ES4408	G 1/4	26.0	14
118876	DGNG38ES4408	G 3/8	28.0	18
118877	DGNG12ES4408	G 1/2	33.5	22
118878	DGNG34ES4408	G 3/4	38.0	28
118879	DGNG1ES4408	G 1	41.5	36
118880	DGNG114ES4408	G 1 1/4	47.5	44
118881	DGNG112ES4408	G 1 1/2	47.5	50
118882	DGNG2ES4408	G 2	57.0	62

NEW Double nipples

stainless steel 1.4408

Double nipples, hexagonal, conical, DIN EN ISO 7-1

Art. No.	Type No.	Thread	Max. working pressure bar	L1 mm	a/f mm
118228	DGNR18ES4408	R 1/8	20	29.5	12
118251	DGNR14ES4408	R 1/4	20	26.0	14
118252	DGNR38ES4408	R 3/8	20	28.0	18
118253	DGNR12ES4408	R 1/2	20	33.5	22
118295	DGNR34ES4408	R 3/4	20	38.0	28
118317	DGNR1ES4408	R 1	20	41.5	36
118318	DGNR114ES4408	R 1 1/4	20	47.5	44
118319	DGNR112ES4408	R 1 1/2	20	47.5	50
118320	DGNR2ES4408	R 2	20	57.0	62
118321	DGNR212ES4408	R 2 1/2	20	67.0	78
118322	DGNR3ES4408	R 3	20	75.0	91



DGNR1ES4408

→ to seal our stainless steel screw connection with conical thread, we recommend the use of thread sealant such as sealing tape on side 877 or Lock on side 908



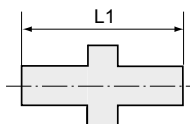

NEW Double nipples, unequal

stainless steel 1.4408



DGNG138ES4408RED

Double nipple, unequal, hexagonal, cylindrical, DIN EN ISO 228-1

Art. No.	Type No.	Male thread 1	Male thread 2	Max. working pressure bar	L1 mm	a/f mm
119197	DGNG1418ES4408RED	G 1/4	G 1/8	20	22.5	15
119198	DGNG3818ES4408RED	G 3/8	G 1/8	20	24.0	18
119237	DGNG3814ES4408RED	G 3/8	G 1/4	20	26.5	18
119238	DGNG1214ES4408RED	G 1/2	G 1/4	20	30.0	22
119239	DGNG1238ES4408RED	G 1/2	G 3/8	20	30.5	22
119240	DGNG3438ES4408RED	G 3/4	G 3/8	20	32.0	28
119241	DGNG3412ES4408RED	G 3/4	G 1/2	20	35.5	28
119313	DGNG138ES4408RED	G 1	G 3/8	20	35.0	34
119242	DGNG112ES4408RED	G 1	G 1/2	20	38.5	34
119252	DGNG134ES4408RED	G 1	G 3/4	20	39.5	34
119253	DGNG11434ES4408RED	G 1 1/4	G 3/4	20	42.5	43
119254	DGNG1141ES4408RED	G 1 1/4	G 1	20	45.0	43
119312	DGNG11234ES4408RED	G 1 1/2	G 3/4	20	42.5	50
119274	DGNG1121ES4408RED	G 1 1/2	G 1	20	45.0	50
119275	DGNG112114ES4408RED	G 1 1/2	G 1 1/4	20	47.5	50
119314	DGNG21ES4408RED	G 2	G 1	20	49.0	61
119310	DGNG2114ES4408RED	G 2	G 1 1/4	20	51.5	61
119311	DGNG2112ES4408RED	G 2	G 1 1/2	20	51.5	61

NEW Double nipples, unequal

stainless steel 1.4408



DGNG112ES4408RED

Double nipples, unequal, hexagonal, conical, DIN EN ISO 7-1

Art. No.	Type No.	Male thread 1	Male thread 2	Max. working pressure bar	L1 mm	a/f mm
118528	DGNG1418ES4408RED	R 1/4	R 1/8	20	22.5	15
118529	DGNG3818ES4408RED	R 3/8	R 1/8	20	24.0	18
118530	DGNG3814ES4408RED	R 3/8	R 1/4	20	26.5	18
118538	DGNG1214ES4408RED	R 1/2	R 1/4	20	30.0	22
118540	DGNG1238ES4408RED	R 1/2	R 3/8	20	30.5	22
118541	DGNG3438ES4408RED	R 3/4	R 3/8	20	32.0	28
118542	DGNG3412ES4408RED	R 3/4	R 1/2	20	35.5	28
118555	DGNG138ES4408RED	R 1	R 3/8	20	35.0	34
118543	DGNG112ES4408RED	R 1	R 1/2	20	38.5	34
118544	DGNG134ES4408RED	R 1	R 3/4	20	39.5	34
118545	DGNG11434ES4408RED	R 1 1/4	R 3/4	20	42.5	43
118546	DGNG1141ES4408RED	R 1 1/4	R 1	20	45.0	43
118554	DGNG11234ES4408RED	R 1 1/2	G 3/4	20	42.5	50
118547	DGNG1121ES4408RED	R 1 1/2	R 1	20	45.0	50
118548	DGNG112114ES4408RED	R 1 1/2	R 1 1/4	20	47.5	50
118556	DGNG21ES4408RED	R 2	R 1	20	49.0	61
118549	DGNG2114ES4408RED	R 2	R 1 1/4	20	51.5	61
118550	DGNG2112ES4408RED	R 2	R 1 1/2	20	51.5	61
118551	DGNG2122ES4408RED	R 2 1/2	R 2	20	59.0	80
118552	DGNG32ES4408RED	R 3	R 2	20	72.6	92
118553	DGNG3212ES4408RED	R 3	R 2 1/2	20	76.0	92

→ to seal our stainless steel screw connection with conical thread, we recommend the use of thread sealant such as sealing tape on side 877 or Lock on side 908

NEW Reducing nipples

stainless steel 1.4408

Reducing nipples, hexagonal, cylindrical, DIN EN ISO 228-1

Art. No.	Type No.	Male thread	Female thread	Max. working pressure bar	L1 mm	a/f mm
118932	REDNG1418ES4408	G 1/4	G 1/8	20	14.5	15
118933	REDNG3818ES4408	G 3/8	G 1/8	20	16.0	18
118995	REDNG3814ES4408	G 3/8	G 1/4	20	16.0	18
119031	REDNG1214ES4408	G 1/2	G 1/4	20	19.5	22
119048	REDNG1238ES4408	G 1/2	G 3/8	20	19.5	22
119054	REDNG3438ES4408	G 3/4	G 3/8	20	21.0	28
119055	REDNG3412ES4408	G 3/4	G 1/2	20	21.0	28
119070	REDNG112ES4408	G 1	G 1/2	20	24.0	34
119131	REDNG134ES4408	G 1	G 3/4	20	24.0	34
119135	REDNG11434ES4408	G 1 1/4	G 3/4	20	27.0	43
119138	REDNG1141ES4408	G 1 1/4	G 1	20	27.0	43
119140	REDNG1121ES4408	G 1 1/2	G 1	20	27.0	50
119141	REDNG112114ES4408	G 1 1/2	G 1 1/4	20	27.0	50
119145	REDNG21ES4408	G 2	G 1	20	31.0	61
119143	REDNG2112ES4408	G 2	G 1 1/2	20	31.0	61

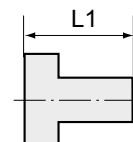

REDNG112ES4408

Reducing nipples, hexagonal, conical, DIN EN ISO 7-1

Art. No.	Type No.	Male thread	Female thread	Max. working pressure bar	L1 mm	a/f mm
118412	REDNR1418ES4408	R 1/4	Rp 1/8	20	14.5	15
118413	REDNR3818ES4408	R 3/8	Rp 1/8	20	16.0	18
118414	REDNR3814ES4408	R 3/8	Rp 1/4	20	16.0	18
118415	REDNR1214ES4408	R 1/2	Rp 1/4	20	19.5	22
118466	REDNR1238ES4408	R 1/2	Rp 3/8	20	19.5	22
118467	REDNR3438ES4408	R 3/4	Rp 3/8	20	21.0	28
118468	REDNR3412ES4408	R 3/4	Rp 1/2	20	21.0	28
118469	REDNR112ES4408	R 1	Rp 1/2	20	24.0	34
118470	REDNR134ES4408	R 1	Rp 3/4	20	24.0	34
118486	REDNR11434ES4408	R 1 1/4	Rp 3/4	20	27.0	43
118487	REDNR1141ES4408	R 1 1/4	Rp 1	20	27.0	43
118488	REDNR1121ES4408	R 1 1/2	Rp 1	20	27.0	50
118489	REDNR112114ES4408	R 1 1/2	Rp 1 1/4	20	27.0	50
118491	REDNR21ES4408	R 2	Rp 1	20	31.0	61
118490	REDNR2112ES4408	R 2	Rp 1 1/2	20	31.0	61



REDNR112ES4408

→ to seal our stainless steel screw connection with conical thread, we recommend the use of thread sealant such as sealing tape on side 877 or Lock on side 908



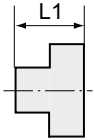

NEW Screw plugs

stainless steel 1.4408



VSTG1ES4408VK

Screw plug, square, cylindrical, DIN EN ISO 228-1

Art. No.	Type No.	Thread	Max. working pressure bar	L1 mm	a/f mm
118892	VSTG18ES4408VK	G 1/8	20	15.7	8
118893	VSTG14ES4408VK	G 1/4	20	19.0	9
118894	VSTG38ES4408VK	G 3/8	20	18.0	9
118895	VSTG12ES4408VK	G 1/2	20	18.5	10
118896	VSTG34ES4408VK	G 3/4	20	21.0	14
118903	VSTG1ES4408VK	G 1	20	24.0	17
118904	VSTG114ES4408VK	G 1 1/4	20	28.0	20
118916	VSTG112ES4408VK	G 1 1/2	20	28.0	23
118930	VSTG2ES4408VK	G 2	20	34.0	28



VSTR1ES4408VK

Screw plug, square, conical, DIN EN ISO 7-1

Art. No.	Type No.	Thread	Max. working pressure bar	L1 mm	a/f mm
118351	VSTR18ES4408VK	R 1/8	20	15.7	8
118352	VSTR14ES4408VK	R 1/4	20	19.0	9
118353	VSTR38ES4408VK	R 3/8	20	18.0	9
118354	VSTR12ES4408VK	R 1/2	20	18.5	10
118365	VSTR34ES4408VK	R 3/4	20	21.0	14
118381	VSTR1ES4408VK	R 1	20	24.0	17
118386	VSTR114ES4408VK	R 1 1/4	20	28.0	20
118390	VSTR112ES4408VK	R 1 1/2	20	28.0	23
118394	VSTR2ES4408VK	R 2	20	34.0	28



VSTG1ES4408SK

Screw plug, hexagonal, cylindrical, DIN EN ISO 228-1

Art. No.	Type No.	Thread	Max. working pressure bar	L1 mm	a/f mm
119320	VSTG18ES4408SK	G 1/8	20	17.7	17
119321	VSTG14ES4408SK	G 1/4	20	17.7	17
119324	VSTG38ES4408SK	G 3/8	20	18.5	18
119325	VSTG12ES4408SK	G 1/2	20	19.5	22
119326	VSTG34ES4408SK	G 3/4	20	22.0	28
119327	VSTG1ES4408SK	G 1	20	24.8	36
119328	VSTG114ES4408SK	G 1 1/4	20	28.8	44
119329	VSTG112ES4408SK	G 1 1/2	20	28.8	50
119330	VSTG2ES4408SK	G 2	20	33.5	62



VSTR1ES4408SK

Screw plug, hexagonal, conical, DIN EN ISO 7-1

Art. No.	Type No.	Thread	Max. working pressure bar	L1 mm	a/f mm
118557	VSTR18ES4408SK	R 1/8	20	17.7	17
118558	VSTR14ES4408SK	R 1/4	20	17.7	17
118559	VSTR38ES4408SK	R 3/8	20	18.5	18
118578	VSTR12ES4408SK	R 1/2	20	19.5	22
118579	VSTR34ES4408SK	R 3/4	20	22.0	28
118580	VSTR1ES4408SK	R 1	20	24.8	36
118581	VSTR114ES4408SK	R 1 1/4	20	28.8	44
118583	VSTR112ES4408SK	R 1 1/2	20	28.8	50
118584	VSTR2ES4408SK	R 2	20	33.5	62

→ to seal our stainless steel screw connection with conical thread, we recommend the use of thread sealant such as sealing tape on side 877 or Lock on side 908

NEW Caps

stainless steel 1.4408

Cap, round, cylindrical, DIN EN ISO 228-1

Art. No.	Type No.	Thread	Max. working pressure bar	L1 mm	Cross-section
118883	VKG18ES4408RU	G 1/8	20	13.7	round
118884	VKG14ES4408RU	G 1/4	20	15.6	round
118885	VKG38ES4408RU	G 3/8	20	16.9	round
118886	VKG12ES4408RU	G 1/2	20	18.6	round
118887	VKG34ES4408RU	G 3/4	20	20.0	round
118888	VKG1ES4408RU	G 1	20	23.0	round
118889	VKG114ES4408RU	G 1 1/4	20	26.2	round
118890	VKG112ES4408RU	G 1 1/2	20	26.2	round
118891	VKG2ES4408RU	G 2	20	31.0	round



VKG1ES4408RU

Cap, round, conical, DIN EN ISO 7-1

Art. No.	Type No.	Thread	Max. working pressure bar	L1 mm	Cross-section
118323	VKRP18ES4408RU	Rp 1/8	20	13.7	round
118324	VKRP14ES4408RU	Rp 1/4	20	15.6	round
118330	VKRP38ES4408RU	Rp 3/8	20	16.9	round
118335	VKRP12ES4408RU	Rp 1/2	20	18.6	round
118336	VKRP34ES4408RU	Rp 3/4	20	20.0	round
118339	VKRP1ES4408RU	Rp 1	20	23.0	round
118348	VKRP114ES4408RU	Rp 1 1/4	20	26.2	round
118349	VKRP112ES4408RU	Rp 1 1/2	20	26.2	round
118350	VKRP2ES4408RU	Rp 2	20	31.0	round



VKRP1ES4408RU

Cap, cylindrical

Art. No.	Type No.	Thread	Max. working pressure bar	L1 mm	a/f mm	Cross-section
119341	VKG18ES4408SK	G 1/8	20	11.8	13	Hexagonal
119342	VKG14ES4408SK	G 1/4	20	15.0	16	Hexagonal
119343	VKG38ES4408SK	G 3/8	20	15.4	20	Hexagonal
119345	VKG12ES4408SK	G 1/2	20	17.1	24	Hexagonal
119364	VKG34ES4408SK	G 3/4	20	18.5	30	Hexagonal
119365	VKG1ES4408SK	G 1	20	21.0	37	Hexagonal
119366	VKG114ES4408SK	G 1 1/4	20	23.7	46	Hexagonal
119367	VKG112ES4408SK	G 1 1/2	20	23.7	52	Octagonal
119375	VKG2ES4408SK	G 2	20	27.5	65	Octagonal



VKG1ES4408SK

Cap, conical

Art. No.	Type No.	Thread	Max. working pressure bar	L1 mm	a/f mm	Cross-section
118585	VKRP18ES4408SK	Rp 1/8	20	11.8	13	Hexagonal
118586	VKRP14ES4408SK	Rp 1/4	20	15.0	16	Hexagonal
118587	VKRP38ES4408SK	Rp 3/8	20	15.4	20	Hexagonal
118654	VKRP12ES4408SK	Rp 1/2	20	17.1	24	Hexagonal
118694	VKRP34ES4408SK	Rp 3/4	20	18.5	30	Hexagonal
118695	VKRP1ES4408SK	Rp 1	20	21.0	37	Hexagonal
118696	VKRP114ES4408SK	Rp 1 1/4	20	23.7	46	Hexagonal
118697	VKRP112ES4408SK	Rp 1 1/2	20	23.7	52	Octagonal
118698	VKRP2ES4408SK	Rp 2	20	27.5	65	Octagonal



VKRP1ES4408SK

→ to seal our stainless steel screw connection with conical thread, we recommend the use of thread sealant such as sealing tape on side 877 or Lock on side 908



NEW Reducing sockets

stainless steel 1.4408



REDMG112ES4408

Reducing socket, round, cylindrical, DIN EN ISO 228-1

Art. No.	Type No.	Female thread 1	Female thread 2	Max. working pressure bar	L1 mm
119149	REDMG1418ES4408	G 1/4	G 1/8	20	24.9
119150	REDMG3818ES4408	G 3/8	G 1/8	20	27.1
119151	REDMG3814ES4408	G 3/8	G 1/4	20	29.0
119196	REDMG1218ES4408	G 1/2	G 1/8	20	21.0
119152	REDMG1214ES4408	G 1/2	G 1/4	20	25.0
119154	REDMG1238ES4408	G 1/2	G 3/8	20	28.0
119156	REDMG3438ES4408	G 3/4	G 3/8	20	24.5
119157	REDMG3412ES4408	G 3/4	G 1/2	20	32.5
119184	REDMG138ES4408	G 1	G 3/8	20	27.0
119158	REDMG112ES4408	G 1	G 1/2	20	29.5
119159	REDMG134ES4408	G 1	G 3/4	20	36.4
119163	REDMG11434ES4408	G 1 1/4	G 3/4	20	33.0
119195	REDMG11412ES4408	G 1 1/4	G 1/2	20	32.0
119164	REDMG1141ES4408	G 1 1/4	G 1	20	42.0
119186	REDMG11234ES4408	G 1 1/2	G 3/4	20	33.0
119167	REDMG1121ES4408	G 1 1/2	G 1	20	34.5
119169	REDMG112114ES4408	G 1 1/2	G 1 1/4	20	44.3
119193	REDMG21ES4408	G 2	G 1	20	38.0
119170	REDMG2114ES4408	G 2	G 1 1/4	20	40.0
119183	REDMG2112ES4408	G 2	G 1 1/2	20	47.8



REDMRP112ES4408

Reducing socket, round, conical, DIN EN ISO 7-1

Art. No.	Type No.	Female thread 1	Female thread 2	Max. working pressure bar	L1 mm
118494	REDMRP1418ES4408	Rp 1/4	Rp 1/8	20	24.9
118495	REDMRP3818ES4408	Rp 3/8	Rp 1/8	20	27.1
118496	REDMRP3814ES4408	Rp 3/8	Rp 1/4	20	29.0
118527	REDMRP1218ES4408	Rp 1/2	Rp 1/8	20	21.0
118497	REDMRP1214ES4408	Rp 1/2	Rp 1/4	20	25.0
118498	REDMRP1238ES4408	Rp 1/2	Rp 3/8	20	28.0
118499	REDMRP3438ES4408	Rp 3/4	Rp 3/8	20	24.5
118501	REDMRP3412ES4408	Rp 3/4	Rp 1/2	20	32.5
118523	REDMRP138ES4408	Rp 1	Rp 3/8	20	27.0
118502	REDMRP112ES4408	Rp 1	Rp 1/2	20	29.5
118503	REDMRP134ES4408	Rp 1	Rp 3/4	20	36.4
118504	REDMRP11434ES4408	Rp 1 1/4	Rp 3/4	20	33.0
118505	REDMRP11412ES4408	Rp 1 1/4	Rp 1/2	20	42.0
118526	REDMRP11412ES4408	Rp 1 1/4	Rp 1 1/2	20	32.0
118524	REDMRP11234ES4408	Rp 1 1/2	Rp 3/4	20	33.0
118506	REDMRP1121ES4408	Rp 1 1/2	Rp 1	20	34.5
118520	REDMRP112114ES4408	Rp 1 1/2	Rp 1 1/4	20	44.3
118525	REDMRP21ES4408	Rp 2	Rp 1	20	38.0
118521	REDMRP2114ES4408	Rp 2	Rp 1 1/4	20	40.0
118522	REDMRP2112ES4408	Rp 2	Rp 1 1/2	20	47.8

→ to seal our stainless steel screw connection with conical thread, we recommend the use of thread sealant such as sealing tape on side 877 or Lock on side 908

NEW Sockets

stainless steel 1.4408

Socket, round, cylindrical, DIN EN ISO 228-1

Art. No.	Type No.	Thread	Max. working pressure bar	L1 mm
118769	MUG18ES4408L	G 1/8	20	17.0
118772	MUG14ES4408L	G 1/4	20	24.0
118774	MUG38ES4408L	G 3/8	20	25.0
118775	MUG12ES4408L	G 1/2	20	27.0
118780	MUG34ES4408L	G 3/4	20	31.0
118782	MUG1ES4408L	G 1	20	34.0
118783	MUG114ES4408L	G 1 1/4	20	38.0
118784	MUG112ES4408L	G 1 1/2	20	38.0
118785	MUG2ES4408L	G 2	20	46.0



MUG1ES4408L

Socket, round, conical, DIN EN ISO 7-1

Art. No.	Type No.	Thread	Max. working pressure bar	L1 mm
117884	MURP18ES4408L	Rp 1/8	20	17.0
117889	MURP14ES4408L	Rp 1/4	20	24.0
117892	MURP38ES4408L	Rp 3/8	20	25.0
117893	MURP12ES4408L	Rp 1/2	20	27.0
117894	MURP34ES4408L	Rp 3/4	20	31.0
117895	MURP1ES4408L	Rp 1	20	34.0
117897	MURP114ES4408L	Rp 1 1/4	20	38.0
117898	MURP112ES4408L	Rp 1 1/2	20	38.0
117899	MURP2ES4408L	Rp 2	20	46.0



MURP1ES4408L

Socket, round, cylindrical, short type, DIN EN ISO 228-1

Art. No.	Type No.	Thread	Max. working pressure bar	L1 mm
119383	MUG18ES4408K	G 1/8	20	8.2
119384	MUG14ES4408K	G 1/4	20	10.7
119399	MUG38ES4408K	G 3/8	20	12.2
119400	MUG12ES4408K	G 1/2	20	15.2
119401	MUG34ES4408K	G 3/4	20	16.2
119403	MUG1ES4408K	G 1	20	19.9
119404	MUG114ES4408K	G 1 1/4	20	22.3
119405	MUG112ES4408K	G 1 1/2	20	22.3
119406	MUG2ES4408K	G 2	20	26.4



MUG1ES4408K

Socket, round, conical, short type, DIN EN ISO 7-1

Art. No.	Type No.	Thread	Max. working pressure bar	L1 mm
118699	MURP18ES4408K	Rp 1/8	20	8.2
118700	MURP14ES4408K	Rp 1/4	20	10.7
118701	MURP38ES4408K	Rp 3/8	20	12.2
118702	MURP12ES4408K	Rp 1/2	20	15.2
118703	MURP34ES4408K	Rp 3/4	20	16.2
118704	MURP1ES4408K	Rp 1	20	19.9
118735	MURP114ES4408K	Rp 1 1/4	20	22.3
118736	MURP112ES4408K	Rp 1 1/2	20	22.3
118764	MURP2ES4408K	Rp 2	20	26.4



MURP114ES4408K

→ to seal our stainless steel screw connection with conical thread, we recommend the use of thread sealant such as sealing tape on side 877 or Lock on side 908



NEW Lock nuts

stainless steel 1.4408



SKMG18ES4408

Hexagonal lock nut

Art. No.	Type No.	Thread	Max. working pressure bar	a/f mm
119331	SKMG18ES4408	G 1/8	20	18
119332	SKMG14ES4408	G 1/4	20	22
119334	SKMG38ES4408	G 3/8	20	27
119335	SKMG12ES4408	G 1/2	20	32
119336	SKMG34ES4408	G 3/4	20	36
119337	SKMG1ES4408	G 1	20	46
119338	SKMG114ES4408	G 1 1/4	20	55
119339	SKMG112ES4408	G 1 1/2	20	60
119340	SKMG2ES4408	G 2	20	75

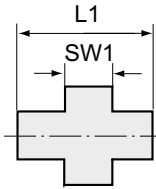

NEW Detachable double nipples

stainless steel 1.4408

Detachable double nipple, cylindrical female, taper seat

Art. No.	Type No.	Thread	Max. working pressure bar	L1 mm	a/f 1 mm
118786	LDGNG14ES4408KDII	G 1/4	20	33.3	30
118788	LDGNG38ES4408KDII	G 3/8	20	35.3	34
118790	LDGNG12ES4408KDII	G 1/2	20	37.4	38
118792	LDGNG34ES4408KDII	G 3/4	20	40.5	46
118793	LDGNG1ES4408KDII	G 1	20	50.3	54
118794	LDGNG114ES4408KDII	G 1 1/4	20	52.0	65
118807	LDGNG112ES4408KDII	G 1 1/2	20	56.3	72
118842	LDGNG2ES4408KDII	G 2	20	62.8	86



LDGNG1ES4408KDII

Detachable double nipple, conical female, taper seat

Art. No.	Type No.	Thread	Max. working pressure bar	L1 mm	a/f 1 mm
117902	LDGNR14ES4408KDII	Rp 1/4	20	33.3	30
117905	LDGNR38ES4408KDII	Rp 3/8	20	35.3	34
117906	LDGNR12ES4408KDII	Rp 1/2	20	37.4	38
117907	LDGNR34ES4408KDII	Rp 3/4	20	40.5	46
117909	LDGNR1ES4408KDII	Rp 1	20	50.3	54
117971	LDGNR114ES4408KDII	Rp 1 1/4	20	52.0	65
117999	LDGNR112ES4408KDII	Rp 1 1/2	20	56.3	72
118000	LDGNR2ES4408KDII	Rp 2	20	62.8	85



LDGNR1ES4408KDII

Detachable double nipple, cylindrical female-male, taper seat

Art. No.	Type No.	Thread	Max. working pressure bar	L1 mm	a/f 1 mm
118855	LDGNG14ES4408KDIA	G 1/4	20	44.3	30
118856	LDGNG38ES4408KDIA	G 3/8	20	48.2	34
118857	LDGNG12ES4408KDIA	G 1/2	20	52.5	38
118858	LDGNG34ES4408KDIA	G 3/4	20	57.5	46
118859	LDGNG1ES4408KDIA	G 1	20	68.0	54
118860	LDGNG114ES4408KDIA	G 1 1/4	20	72.0	65
118861	LDGNG112ES4408KDIA	G 1 1/2	20	80.0	72
118862	LDGNG2ES4408KDIA	G 2	20	89.0	86



LDGNG1ES4408KDIA

NEW Detachable double nipples

stainless steel 1.4408

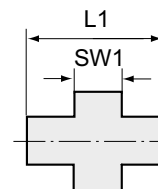

Detachable double nipple, conical female-male, taper seat

Art. No.	Type No.	Thread	Max. working pressure bar	L1 mm	a/f 1 mm
118093	LDG NR14ES4408KDIA	Rp 1/4	20	44.3	30
118094	LDG NR38ES4408KDIA	Rp 3/8	20	48.2	34
118095	LDG NR12ES4408KDIA	Rp 1/2	20	52.5	38
118096	LDG NR34ES4408KDIA	Rp 3/4	20	57.5	46
118104	LDG NR1ES4408KDIA	Rp 1	20	68.0	54
118105	LDG NR114ES4408KDIA	Rp 1 1/4	20	72.0	65
118106	LDG NR112ES4408KDIA	Rp 1 1/2	20	80.0	72
118107	LDG NR2ES4408KDIA	Rp 2	20	89.0	86



LDG NR1ES4408KDIA

Detachable double nipple, cylindrical female, flat seal PTFE

Art. No.	Type No.	Thread	Max. working pressure bar	L1 mm	a/f 1 mm
118843	LDG NG14ES4408FDII	G 1/4	20	32.0	30
118844	LDG NG38ES4408FDII	G 3/8	20	35.5	34
118845	LDG NG12ES4408FDII	G 1/2	20	37.5	38
118846	LDG NG34ES4408FDII	G 3/4	20	42.0	46
118847	LDG NG1ES4408FDII	G 1	20	50.0	54
118849	LDG NG114ES4408FDII	G 1 1/4	20	51.5	65
118850	LDG NG112ES4408FDII	G 1 1/2	20	58.0	72
118851	LDG NG2ES4408FDII	G 2	20	64.0	86



LDG NG1ES4408FDII

Detachable double nipple, conical female, flat seal PTFE

Art. No.	Type No.	Thread	Max. working pressure bar	L1 mm	a/f 1 mm
118059	LDG NR14ES4408FDII	Rp 1/4	20	32.0	30
118064	LDG NR38ES4408FDII	Rp 3/8	20	35.5	34
118065	LDG NR12ES4408FDII	Rp 1/2	20	37.5	38
118067	LDG NR34ES4408FDII	Rp 3/4	20	42.0	46
118068	LDG NR1ES4408FDII	Rp 1	20	50.0	54
118077	LDG NR114ES4408FDII	Rp 1 1/4	20	51.5	65
118082	LDG NR112ES4408FDII	Rp 1 1/2	20	58.0	72
118092	LDG NR2ES4408FDII	Rp 2	20	64.0	86



LDG NR1ES4408FDII

Detachable double nipple, cylindrical female-male, flat seal PTFE

Art. No.	Type No.	Thread	Max. working pressure bar	L1 mm	a/f 1 mm
118863	LDG NG14ES4408FDIA	G 1/4	20	45.8	30
118867	LDG NG38ES4408FDIA	G 3/8	20	51.0	34
118868	LDG NG12ES4408FDIA	G 1/2	20	52.0	38
118869	LDG NG34ES4408FDIA	G 3/4	20	58.0	46
118870	LDG NG1ES4408FDIA	G 1	20	68.8	54
118871	LDG NG114ES4408FDIA	G 1 1/4	20	71.0	65
118872	LDG NG112ES4408FDIA	G 1 1/2	20	80.0	72
118873	LDG NG2ES4408FDIA	G 2	20	90.5	86



LDG NG1ES4408FDIA

Detachable double nipple, conical female-male, flat seal PTFE

Art. No.	Type No.	Thread	Max. working pressure bar	L1 mm	a/f 1 mm
118108	LDG NR14ES4408FDIA	Rp 1/4	20	45.8	30
118118	LDG NR38ES4408FDIA	Rp 3/8	20	51.0	34
118120	LDG NR12ES4408FDIA	Rp 1/2	20	52.0	38
118171	LDG NR34ES4408FDIA	Rp 3/4	20	58.0	46
118224	LDG NR1ES4408FDIA	Rp 1	20	68.8	54
118225	LDG NR114ES4408FDIA	Rp 1 1/4	20	71.0	65



LDG NR1ES4408FDIA



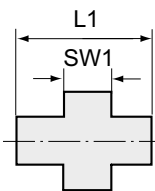

NEW Detachable double nipples

stainless steel 1.4408

Detachable double nipple, conical female-male, flat seal PTFE

Art. No.	Type No.	Thread	Max. working pressure bar	L1 mm	a/f 1 mm
118226	LDGNR112ES4408FDIA	Rp 1 1/2	20	80.0	72
118227	LDGNR2ES4408FDIA	Rp 2	20	90.5	86

→ to seal our stainless steel screw connection with conical thread, we recommend the use of thread sealant such as sealing tape on side 877 or Lock on side 908

Bite-type tube fittings

lightweight series acc. DIN 2353

Max. temperature range	150 °C
Max. operating pressure	60 bar

Male connectors

lightweight series acc. DIN 2353

PLUS

Material	Nickel-plated brass
----------	---------------------

Male connector, conical male thread acc. to ISO 7-1

Art. No.	Type No.	Thread	Tube O.D. mm	L1 mm	a/f mm	a/f 1 mm
111964	N 21	R 1/8	4	27.0	10	10
111965	N 23	R 1/8	6	28.0	12	12
111966	N 24	R 1/8	8	29.5	12	14
111967	N 28	R 1/4	6	32.5	14	12
111968	N 29	R 1/4	8	33.0	14	14
111969	N 30	R 1/4	10	37.5	17	19
111970	N 34	R 3/8	8	33.0	17	14
111971	N 35	R 3/8	10	38.0	17	19
111972	N 36	R 3/8	12	39.0	19	22
111973	N 39	R 1/2	10	40.5	22	19
111974	N 40	R 1/2	12	41.0	22	22
111975	N 41	R 1/2	15	42.5	22	27
111976	N 42	R 1/2	18	43.0	26	32

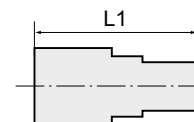

N 29

Unions

lightweight series acc. DIN 2353

PLUS

Material	Nickel-plated brass
----------	---------------------

Union, pipe connection on both sides

Art. No.	Type No.	Tube O.D. mm	L1 mm	a/f mm	a/f 1 mm
111989	N 50	4	34.0	10	10
111990	N 54	6	35.0	12	12
111991	N 55	8	38.5	14	14
111992	N 56	10	47.5	17	19
111993	N 57	12	48.0	19	22
111994	N 58	15	50.0	24	27
111995	N 59	18	56.0	26	32

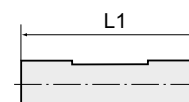

N 55



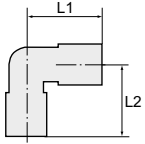

Male elbows

lightweight series acc. DIN 2353

PLUS

Material Nickel-plated brass



N 93

Male elbow, conical male thread acc. to ISO 7-1

Art. No.	Type No.	Thread	Tube O.D. mm	L1 mm	L2 mm	a/f mm	a/f 1 mm
112007	N 89	R 1/8	4	21.0	16.0	9	10
112008	N 90	R 1/8	6	22.0	16.0	9	12
112009	N 91	R 1/8	8	24.0	17.0	11	14
112010	N 92	R 1/4	6	24.5	20.0	11	12
112011	N 93	R 1/4	8	24.0	20.0	11	14
112012	N 94	R 1/4	10	32.0	23.5	13	19
112013	N 97	R 3/8	8	27.0	24.0	13	14
112014	N 98	R 3/8	10	32.0	24.0	13	19
112015	N 99	R 3/8	12	34.5	25.5	15	22
112016	N 101	R 1/2	10	34.0	28.5	15	19
112017	N 102	R 1/2	12	34.5	28.5	15	22
112018	N 103	R 1/2	15	38.0	30.0	17	27
112019	N 104	R 1/2	18	44.0	34.0	22	32

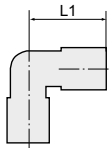

Union elbows

lightweight series acc. DIN 2353

PLUS

Material Nickel-plated brass



N 75

Union elbow, pipe connection on both sides

Art. No.	Type No.	Tube O.D. mm	L1 mm	a/f mm	a/f 1 mm
111996	N 73	4	21.0	9	10
111997	N 74	6	23.0	9	12
111998	N 75	8	24.0	11	14
111999	N 76	10	32.0	13	19
112000	N 77	12	34.5	15	22
112001	N 78	15	38.0	17	27
112002	N 79	18	44.0	22	32

Banjo elbows

lightweight series acc. DIN 2353

PLUS

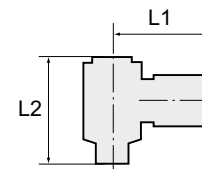

Material	Nickel-plated brass
----------	---------------------

Schwenkbare Winkel-Verschraubung, Außengewinde zylindrisch mit O-Ring

Art. No.	Type No.	Thread	Tube O.D. mm	L1 mm	L2 mm	a/f mm	a/f 1 mm
112003	N 81	G 1/8	6	26.5	28.0	14	12
112004	N 82	G 1/8	8	25.5	28.0	14	14
112005	N 83	G 1/4	6	28.5	29.5	17	12
112006	N 84	G 1/4	8	28.0	29.5	17	14



N 84

Branch tees

lightweight series acc. DIN 2353

PLUS

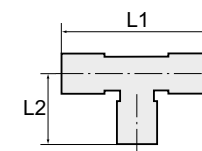

Material	Nickel-plated brass
----------	---------------------

Male branch tee, conical male thread acc. to ISO 7-1

Art. No.	Type No.	Thread	Tube O.D. mm	L1 mm	L2 mm	a/f mm	a/f 1 mm
112028	N 110	R 1/8	4	44.0	16.0	9	10
112029	N 112	R 1/8	6	46.0	16.0	9	12
112030	N 115	R 1/8	8	48.0	17.0	11	14
112031	N 116	R 1/4	6	46.0	20.0	11	12
112032	N 117	R 1/4	8	48.0	20.0	11	14
112033	N 118	R 1/4	10	64.0	23.5	13	19
112034	N 119	R 3/8	8	54.0	24.0	13	14
112035	N 120	R 3/8	10	64.0	24.0	13	19
112036	N 121	R 3/8	12	69.0	25.5	15	22
112037	N 124	R 1/2	12	69.0	28.5	14	22
112038	N 125	R 1/2	15	76.0	30.0	17	27
112039	N 126	R 1/2	18	88.0	34.0	22	32



N 117

Branch tee, pipe connection on all sides

Art. No.	Type No.	Tube O.D. mm	L1 mm	L2 mm	a/f mm	a/f 1 mm
112040	N 130	4	44.0	21.0	9	10
112041	N 135	6	46.0	23.0	9	12
112042	N 136	8	48.0	24.0	11	14
112043	N 137	10	64.0	32.0	13	19
112044	N 138	12	69.0	34.5	15	22
112045	N 139	15	76.0	38.0	17	27
112046	N 140	18	88.0	44.0	22	32



N 136



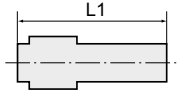

Pressure gauge fittings

lightweight series acc. DIN 2353

PLUS ||

Material Nickel-plated brass



N 64

Pressure gauge fitting with female thread

Art. No.	Type No.	Thread	Tube O.D. mm	L1 mm	a/f mm	a/f 1 mm
111977	N 60	G 1/8	4	24.5	14	10
111978	N 61	G 1/8	6	25.5	14	12
111979	N 62	G 1/8	8	26.5	14	14
111980	N 63	G 1/4	6	30.0	17	12
111981	N 64	G 1/4	8	31.0	17	14
111982	N 65	G 1/4	10	35.5	17	19
111983	N 66	G 3/8	8	31.0	20	14
111984	N 67	G 3/8	10	36.5	20	19
111985	N 68	G 3/8	12	36.0	20	22
111986	N 69	G 1/2	12	39.5	24	22
111987	N 70	G 1/2	15	40.0	24	27
111988	N 71	G 1/2	18	42.0	26	32

Tube inserts

lightweight series acc. DIN 2353

PLUS ||

Material Bare metal surface



VH 8

Tube insert, brass with a bare metal surface

Art. No.	Type No.	Tube O.D. mm
112020	VH 2	4/2
112021	VH 4	6/4
112022	VH 6	8/6
112023	VH 8	10/8
112024	VH 9	12/9
112025	VH 10	12/10
112026	VH 12	15/12
112027	VH 14	18/14

Ferrules

lightweight series acc. DIN 2353

PLUS

Material	Bare metal surface
----------	--------------------

Ferrule, brass with a bare metal surface

Art. No.	Type No.	Tube O.D. mm
112047	N 350	4
112048	N 352	6
112049	N 353	8
112050	N 362	10
112051	N 363	12
112052	N 364	15
112053	N 365	18



N 353

Swivel nuts

lightweight series acc. DIN 2353

PLUS

Material	Nickel-plated brass
----------	---------------------

Swivel nut

Art. No.	Type No.	Thread	Tube O.D. mm
112054	N 400	M8x1.0	4
112055	N 402	M10x1.0	6
112056	N 403	M12x1.0	8
112057	N 407	M16x1.5	10
112058	N 408	M18x1.5	12
112059	N 409	M22x1.5	15
112060	N 410	M26x1.5	18



N 403

Bite-type tube fittings

Galvanised steel (DIN 2353)

Material	Galvanised steel (DIN 2353)
----------	-----------------------------

Male connectors

galvanised steel acc. DIN 2353



Male connector, parallel male thread, light type

Art. No.	Type No.	Thread	Tube O.D. mm	PN bar	L1 mm	L2 mm	a/f 1 mm	a/f 2 mm
159561	GE186LST	G 1/8	6	315	31.0	8.0	14	14
159562	GE146LST	G 1/4	6	315	37.0	12.0	14	19
159563	GE386LST	G 3/8	6	315	38.0	12.0	14	22
159564	GE126LST	G 1/2	6	315	41.0	14.0	14	27
159565	GE188LST	G 1/8	8	315	32.0	8.0	17	14

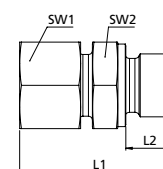

GE186LST

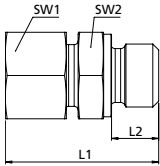

Male connectors

galvanised steel acc. DIN 2353



Male connector, parallel male thread, light type

Art. No.	Type No.	Thread	Tube O.D. mm	PN bar	L1 mm	L2 mm	a/f 1 mm	a/f 2 mm
159566	GE148LST	G 1/4	8	315	37.0	12.0	17	19
159567	GE388LST	G 3/8	8	315	38.0	12.0	17	22
159568	GE128LST	G 1/2	8	315	41.0	14.0	17	27
159569	GE1810LST	G 1/8	10	315	34.0	8.0	19	17
159570	GE1410LST	G 1/4	10	315	38.0	12.0	19	19
159571	GE3810LST	G 3/8	10	315	39.0	12.0	19	22
159572	GE1210LST	G 1/2	10	315	42.0	14.0	19	27
159573	GE1412LST	G 1/4	12	315	39.0	12.0	22	19
159574	GE3812LST	G 3/8	12	315	39.0	12.0	22	22
159575	GE1212LST	G 1/2	12	315	42.0	14.0	22	27
159576	GE3412LST	G 3/4	12	315	45.0	16.0	22	32
159577	GE3815LST	G 3/8	15	315	41.0	12.0	27	24
159578	GE1215LST	G 1/2	15	315	43.0	14.0	27	27
159579	GE3415LST	G 3/4	15	315	46.0	16.0	27	32
159580	GE3818LST	G 3/8	18	315	41.0	12.0	32	27
159581	GE1218LST	G 1/2	18	315	45.0	14.0	32	27
159582	GE3418LST	G 3/4	18	315	46.0	16.0	32	32
159583	GE1222LST	G 1/2	22	160	47.0	14.0	36	32
159584	GE3422LST	G 3/4	22	160	49.0	16.0	36	32
159585	GE122LST	G 1	22	160	52.0	18.0	36	41



GE146SST

Male connector, parallel male thread, heavy type

Art. No.	Type No.	Thread	Tube O.D. mm	PN bar	L1 mm	L2 mm	a/f 1 mm	a/f 2 mm
159586	GE146SST	G 1/4	6	630	40.0	12.0	17	19
159587	GE126SST	G 1/2	6	630	47.0	14.0	17	27
159588	GE148SST	G 1/4	8	630	42.0	12.0	19	19
159589	GE388SST	G 3/8	8	630	42.0	12.0	19	22
159590	GE1410SST	G 1/4	10	630	43.0	12.0	22	19
159591	GE3810SST	G 3/8	10	630	43.0	12.0	22	22
159592	GE1210SST	G 1/2	10	630	48.0	14.0	22	27
159593	GE1412SST	G 1/4	12	630	45.0	12.0	24	22
159594	GE3812SST	G 3/8	12	630	45.0	12.0	24	22
159595	GE1212SST	G 1/2	12	630	48.0	14.0	24	27
159596	GE3814SST	G 3/8	14	630	48.0	12.0	27	24
159597	GE1214SST	G 1/2	14	630	51.0	14.0	27	27
159598	GE3816SST	G 3/8	16	400	48.0	12.0	30	27
159599	GE1216SST	G 1/2	16	400	51.0	14.0	30	27
159600	GE3416SST	G 3/4	16	400	55.0	16.0	30	32
159601	GE1220SST	G 1/2	20	400	56.0	14.0	36	32
159602	GE3420SST	G 3/4	20	400	58.0	16.0	36	32
159603	GE3425SST	G 3/4	25	400	63.0	16.0	46	41
159604	GE125SST	G 1	25	400	65.0	18.0	46	41

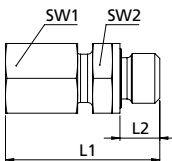

V 28-ZW

Male connector, parallel male thread and soft seal, light type

Art. No.	Type No.	Thread	Tube O.D. mm	PN bar	L1 mm	L2 mm	a/f 1 mm	a/f 2 mm
112249	V 25-ZW	G 1/8	6	315	31.0	8.0	14	14
112251	V 28-ZW	G 1/4	6	315	37.0	12.0	14	19
112255	V 33-ZW	G 3/8	6	315	38.0	12.0	14	22
112250	V 26-ZW	G 1/8	8	315	32.0	8.0	17	14
112252	V 29-ZW	G 1/4	8	315	37.0	12.0	17	19
112256	V 34-ZW	G 3/8	8	315	38.0	12.0	17	22
112260	V 38-ZW	G 1/2	8	315	41.0	14.0	17	27
159605	GE1810LSTNBR	G 1/8	10	315	34.0	8.0	19	17

Male connectors

galvanised steel acc. DIN 2353

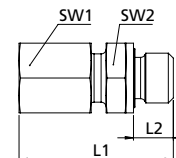

Male connector, parallel male thread and soft seal, light type

Art. No.	Type No.	Thread	Tube O.D. mm	PN bar	L1 mm	L2 mm	a/f 1 mm	a/f 2 mm
112253	V 30-ZW	G 1/4	10	315	38.0	12.0	19	19
112257	V 35-ZW	G 3/8	10	315	39.0	12.0	19	22
112261	V 39-ZW	G 1/2	10	315	42.0	14.0	19	27
112254	V 31-ZW	G 1/4	12	315	38.0	12.0	22	19
112258	V 36-ZW	G 3/8	12	315	39.0	12.0	22	22
112262	V 40-ZW	G 1/2	12	315	42.0	14.0	22	27
159606	GE3415LSTNBR	G 3/4	15	315	46.0	16.0	27	32
112259	V 37-ZW	G 3/8	15	315	41.0	12.0	27	24
112263	V 41-ZW	G 1/2	15	315	43.0	14.0	27	27
112264	V 42-ZW	G 1/2	18	315	45.0	14.0	32	27
112265	V 43-ZW	G 3/4	18	315	46.0	16.0	32	32
159607	GE1222LSTNBR	G 1/2	22	160	47.0	14.0	36	32
112266	V 44-ZW	G 3/4	22	160	49.0	16.0	36	32
159608	GE122LSTNBR	G 1	22	160	52.0	18.0	36	41
159609	GE3428LSTNBR	G 3/4	28	160	50.0	16.0	41	41
159610	GE128LSTNBR	G 1	28	160	52.0	18.0	41	41

Male connector, parallel male thread and soft seal, heavy type

Art. No.	Type No.	Thread	Tube O.D. mm	PN bar	L1 mm	L2 mm	a/f 1 mm	a/f 2 mm
159611	GE146SSTNBR	G 1/4	6	630	40.0	12.0	17	19
159612	GE148SSTNBR	G 1/4	8	630	42.0	12.0	19	19
159613	GE388SSTNBR	G 3/8	8	630	42.0	12.0	19	22
159614	GE1410SSTNBR	G 1/4	10	630	43.0	12.0	22	19
159615	GE3810SSTNBR	G 3/8	10	630	43.0	12.0	22	22
159616	GE1210SSTNBR	G 1/2	10	630	48.0	14.0	22	27
159617	GE1412SSTNBR	G 1/4	12	630	45.0	12.0	24	22
159618	GE3812SSTNBR	G 3/8	12	630	45.0	12.0	24	22
159619	GE1212SSTNBR	G 1/2	12	630	48.0	14.0	24	27
159620	GE3814SSTNBR	G 3/8	14	630	48.0	12.0	27	24
159621	GE1214SSTNBR	G 1/2	14	630	51.0	14.0	27	27
159622	GE3816SSTNBR	G 3/8	16	400	48.0	12.0	30	27
159623	GE1216SSTNBR	G 1/2	16	400	51.0	14.0	30	27
159624	GE3416SSTNBR	G 3/4	16	400	55.0	16.0	30	32
159625	GE1220SSTNBR	G 1/2	20	400	56.0	14.0	36	32
159626	GE3420SSTNBR	G 3/4	20	400	58.0	16.0	36	32
159627	GE3425SSTNBR	G 3/4	25	400	63.0	16.0	46	41
159628	GE125SSTNBR	G 1	25	400	65.0	18.0	46	41



GE146SSTNBR

Male connector, conical male thread acc. to ISO 7-1, very light type

Art. No.	Type No.	Thread	Tube O.D. mm	PN bar	L1 mm	L2 mm	a/f 1 mm	a/f 2 mm
112121	V 21	R 1/8	4	100	26.0	8.0	10	11
112122	V 22	R 1/8	5	100	26.0	8.0	12	11
112123	V 23	R 1/8	6	100	26.0	8.0	12	11
112124	V 24	R 1/8	8	100	28.0	8.0	14	12
159629	GER148SLST	R 1/4	8	100	32.0	12.0	14	14
159630	GER1410SLST	R 1/4	10	100	32.0	12.0	17	14
159631	GER1412SLST	R 1/4	12	100	32.0	12.0	19	17
112125	V 25	R 1/8	6	315	33.0	10.0	14	12
112127	V 28	R 1/4	6	315	37.0	13.0	14	17

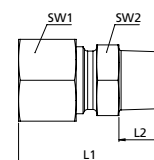

GER148SLST

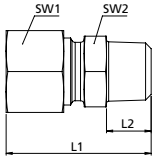

Male connectors

galvanised steel acc. DIN 2353



V 35



GER146SST



GE184SLSTNPT



GE186LSTNPT

Male connector, conical male thread acc. to ISO 7-1, light type

Art. No.	Type No.	Thread	Tube O.D. mm	PN bar	L1 mm	L2 mm	a/f 1 mm	a/f 2 mm
112131	V 33	R 3/8	6	315	34.0	12.0	19	14
112126	V 26	R 1/8	8	315	35.0	10.0	17	14
112128	V 29	R 1/4	8	315	38.0	13.0	17	17
112132	V 34	R 3/8	8	315	39.0	13.0	17	19
112136	V 38	R 1/2	8	315	42.0	16.0	17	22
112129	V 30	R 1/4	10	315	39.0	13.0	19	17
112133	V 35	R 3/8	10	315	40.0	13.0	19	19
112137	V 39	R 1/2	10	315	43.0	16.0	19	22
112130	V 31	R 1/4	12	315	40.0	13.0	22	19
112134	V 36	R 3/8	12	315	40.0	13.0	22	19
112138	V 40	R 1/2	12	315	43.0	16.0	22	22
112135	V 37	R 3/8	15	315	42.0	13.0	27	24
112139	V 41	R 1/2	15	315	45.0	16.0	27	24
112140	V 42	R 1/2	18	315	47.0	16.0	32	27
112141	V 43	R 3/4	18	160	50.0	18.0	32	32
112142	V 44	R 3/4	22	160	51.0	18.0	36	32
159632	GER128LST	R 1	28	160	54.0	20.0	41	41

Male connector, conical male thread acc. to ISO 7-1, heavy type

Art. No.	Type No.	Thread	Tube O.D. mm	PN bar	L1 mm	L2 mm	a/f 1 mm	a/f 2 mm
159633	GER146SST	R 1/4	6	630	41.0	13.0	17	17
159634	GER148SST	R 1/4	8	630	43.0	13.0	19	17
159635	GER1410SST	R 1/4	10	630	44.0	13.0	22	19
159636	GER3810SST	R 3/8	10	630	44.0	13.0	22	19
159637	GER1412SST	R 1/4	12	630	46.0	13.0	24	22
159638	GER3812SST	R 3/8	12	630	46.0	13.0	24	22
159639	GER1212SST	R 1/2	12	630	49.0	16.0	24	22
159640	GER3814SST	R 3/8	14	630	50.0	13.0	27	24
159641	GER1214SST	R 1/2	14	630	53.0	16.0	27	24
159642	GER3816SST	R 3/8	16	400	50.0	13.0	30	27
159643	GER1216SST	R 1/2	16	400	53.0	16.0	30	27
159644	GER3420SST	R 3/4	20	400	60.0	18.0	36	32
159645	GER125SST	R 1	25	400	67.0	20.0	46	41

Male connector, male thread NPT, very light type

Art. No.	Type No.	Thread	Tube O.D. mm	PN bar	L1 mm	L2 mm	a/f 1 mm	a/f 2 mm
159646	GE184SLSTNPT	NPT 1/8	4	100	28.0	10.0	10	11
159647	GE186SLSTNPT	NPT 1/8	6	100	28.0	10.0	12	11
159648	GE188SLSTNPT	NPT 1/8	8	100	30.0	10.0	14	12

Male connector, male thread NPT, light type

Art. No.	Type No.	Thread	Tube O.D. mm	PN bar	L1 mm	L2 mm	a/f 1 mm	a/f 2 mm
159649	GE186LSTNPT	NPT 1/8	6	315	33.0	10.0	14	12
159650	GE146LSTNPT	NPT 1/4	6	315	39.0	15.0	14	17
159651	GE148LSTNPT	NPT 1/4	8	315	40.0	15.0	17	17
159652	GE388LSTNPT	NPT 3/8	8	315	41.0	15.0	17	19
159653	GE1410LSTNPT	NPT 1/4	10	315	41.0	15.0	19	17
159654	GE3810LSTNPT	NPT 3/8	10	315	42.0	15.0	19	19
159655	GE1412LSTNPT	NPT 1/4	12	315	42.0	15.0	22	19
159656	GE3812LSTNPT	NPT 3/8	12	315	42.0	15.0	22	19

Male connectors

galvanised steel acc. DIN 2353

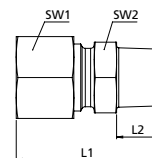

Male connector, male thread NPT, light type

Art. No.	Type No.	Thread	Tube O.D. mm	PN bar	L1 mm	L2 mm	a/f 1 mm	a/f 2 mm
159657	GE1212LSTNPT	NPT 1/2	12	315	47.0	20.0	22	22
159658	GE1215LSTNPT	NPT 1/2	15	315	49.0	20.0	27	24
159659	GE1218LSTNPT	NPT 1/2	18	315	51.0	20.0	32	27
159660	GE3422LSTNPT	NPT 3/4	22	160	53.0	20.0	36	32
159661	GE128LSTNPT	NPT 1	28	160	59.0	25.0	41	41

Male connector, male thread NPT, heavy type

Art. No.	Type No.	Thread	Tube O.D. mm	PN bar	L1 mm	L2 mm	a/f 1 mm	a/f 2 mm
159662	GE146SSTNPT	NPT 1/4	6	630	43.0	15.0	17	17
159663	GE148SSTNPT	NPT 1/4	8	630	45.0	15.0	19	17
159664	GE1410SSTNPT	NPT 1/4	10	630	46.0	15.0	22	19
159665	GE3810SSTNPT	NPT 3/8	10	630	46.0	15.0	22	19
159666	GE1412SSTNPT	NPT 1/4	12	630	48.0	15.0	24	22
159667	GE3812SSTNPT	NPT 3/8	12	630	48.0	15.0	24	22
159668	GE1212SSTNPT	NPT 1/2	12	630	53.0	20.0	24	22
159669	GE1214SSTNPT	NPT 1/2	14	630	57.0	20.0	27	24
159670	GE1216SSTNPT	NPT 1/2	16	400	57.0	20.0	30	27
159671	GE3420SSTNPT	NPT 3/4	20	400	62.0	20.0	36	32
159672	GE125SSTNPT	NPT 1	25	400	72.0	25.0	46	41



GE146SSTNPT

Male connector, male thread UNF, light type

Art. No.	Type No.	Thread	Tube O.D. mm	PN bar	L1 mm	L2 mm	a/f 1 mm	a/f 2 mm
159673	GE7168LSTUNF	UNF 7/16-20	8	315	34.0	9.0	17	17
159674	GE71610LSTUNF	UNF 7/16-20	10	315	35.0	9.0	19	17
159675	GE91612LSTUNF	UNF 9/16-18	12	315	36.0	10.0	22	19
159676	GE3412LSTUNF	UNF 3/4-16	12	315	39.0	11.0	22	24
159677	GE7812LSTUNF	UNF 7/8-14	12	315	41.7	12.7	22	27
159678	GE3415LSTUNF	UNF 3/4-16	15	315	40.0	11.0	27	24
159679	GE3418LSTUNF	UNF 3/4-16	18	315	42.0	11.0	32	27
159680	GE7818LSTUNF	UNF 7/8-14	18	315	43.7	12.7	32	27
159681	GE7822LSTUNF	UNF 7/8-14	22	160	45.7	12.7	36	32
159682	GE111622LSTUNF	UNF 1 1/16-12	22	160	48.0	15.0	36	32
159683	GE151622LSTUNF	UNF 1 5/16-12	22	160	49.0	15.0	36	41
159684	GE111628LSTUNF	UNF 1 1/16-12	28	160	49.0	15.0	41	41
159685	GE151628LSTUNF	UNF 1 5/16-12	28	160	49.0	15.0	41	41



GE7168LSTUNF

Male connector, male thread UNF, heavy type

Art. No.	Type No.	Thread	Tube O.D. mm	PN bar	L1 mm	L2 mm	a/f 1 mm	a/f 2 mm
159686	GE7168SSTUNF	UNF 7/16-20	8	630	39.0	9.0	19	17
159687	GE91610SSTUNF	UNF 9/16-18	10	630	41.0	10.0	22	19
159688	GE91612SSTUNF	UNF 9/16-18	12	630	41.0	10.0	24	22
159689	GE3412SSTUNF	UNF 3/4-16	12	630	45.0	11.0	24	24
159690	GE3416SSTUNF	UNF 3/4-16	16	400	45.0	11.0	30	24
159691	GE7816SSTUNF	UNF 7/8-14	16	400	49.7	12.7	30	27
159692	GE3420SSTUNF	UNF 3/4-16	20	400	53.0	11.0	36	32
159693	GE7820SSTUNF	UNF 7/8-14	20	400	54.7	12.7	36	32
159694	GE111620SSTUNF	UNF 1 1/16-12	20	400	57.0	15.0	36	32
159695	GE111625SSTUNF	UNF 1 1/16-12	25	400	62.0	15.0	46	36
159696	GE151625SSTUNF	UNF 1 5/16-12	25	400	62.0	15.0	46	41



GE7168SSTUNF



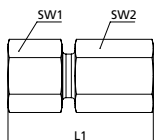

Female connectors

galvanised steel acc. DIN 2353



GAV186LST

Female connector, parallel thread, light type

Art. No.	Type No.	Thread	Tube O.D. mm	PN bar	L1 mm	a/f 2 mm
159129	GAV186LST	G 1/8	6	315	34.0	14
159130	GAV148LST	G 1/4	8	315	39.0	19
159131	GAV388LST	G 3/8	8	315	40.0	24
159132	GAV0128LST	G 1/2	8	315	44.0	27
159133	GAV1410LST	G 1/4	10	315	40.0	19
159134	GAV3810LST	G 3/8	10	315	41.0	24
159135	GAV1210LST	G 1/2	10	315	45.0	27
159136	GAV3812LST	G 3/8	12	315	41.0	24
159137	GAV1212LST	G 1/2	12	315	45.0	27
159138	GAV1215LST	G 1/2	15	315	46.0	27
159139	GAV1218LST	G 1/2	18	315	47.0	27
159140	GAV3422LST	G 3/4	22	160	52.0	36
159141	GAV128LST	G 1	28	160	55.0	41



GAV146SST

Female connector, parallel thread, heavy type

Art. No.	Type No.	Thread	Tube O.D. mm	PN bar	L1 mm	a/f 2 mm
159142	GAV146SST	G 1/4	6	630	41.0	19
159143	GAV148SST	G 1/4	8	630	41.0	19
159144	GAV3810SST	G 3/8	10	630	43.0	24
159145	GAV3812SST	G 3/8	12	630	43.0	24
159146	GAV1214SST	G 1/2	14	630	50.0	30
159147	GAV1216SST	G 1/2	16	400	50.0	30
159148	GAV3420SST	G 3/4	20	400	56.0	36
159149	GAV125SST	G 1	25	400	62.0	41

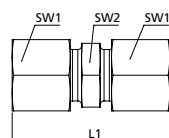

Unions

galvanised steel acc. DIN 2353



GV10SLST

Union, very light type

Art. No.	Type No.	Tube O.D. mm	PN bar	L1 mm	a/f 1 mm	a/f 2 mm
112143	V 50	4	100	31.0	10	9
112144	V 51	5	100	32.0	12	11
112145	V 52	6	100	32.0	12	11
112146	V 53	8	100	35.0	14	12
159708	GV10SLST	10	100	35.0	17	14
159709	GV12SLST	12	100	35.0	19	17



V 55

Union, light type

Art. No.	Type No.	Tube O.D. mm	PN bar	L1 mm	a/f 1 mm	a/f 2 mm
112147	V 54	6	315	39.0	14	12
112148	V 55	8	315	40.0	17	14
112149	V 56	10	315	42.0	19	17
112150	V 57	12	315	43.0	22	19
112151	V 58	15	315	46.0	27	24
112152	V 59	18	315	48.0	32	27
112153	V 60	22	160	52.0	36	32
159710	GV28LST	28	160	54.0	41	41

Unions

galvanised steel acc. DIN 2353

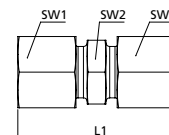

GV6SST

Union, heavy type

Art. No.	Type No.	Tube O.D. mm	PN bar	L1 mm	a/f 1 mm	a/f 2 mm
159711	GV6SST	6	630	45.0	17	14
159712	GV8SST	8	630	47.0	19	17
159713	GV10SST	10	630	49.0	22	19
159714	GV12SST	12	630	51.0	24	22
159715	GV14SST	14	630	57.0	27	24
159716	GV16SST	16	400	57.0	30	27
159717	GV20SST	20	400	66.0	36	32
159718	GV25SST	25	400	74.0	46	41

Male elbows

galvanised steel acc. DIN 2353

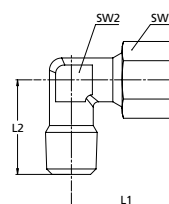

WEVR1410SLST

Male elbow, conical male thread acc. to ISO 7-1, very light type

Art. No.	Type No.	Thread	Tube O.D. mm	PN bar	L1 mm	L2 mm	a/f 1 mm	a/f 2 mm
112165	V 85	R 1/8	4	100	21.0	17.0	10	9
112166	V 86	R 1/8	5	100	21.0	17.0	12	9
112167	V 87	R 1/8	6	100	21.0	17.0	12	9
112168	V 88	R 1/8	8	100	23.0	20.0	14	12
159150	WEVR1410SLST	R 1/4	10	100	27.0	25.0	17	14
159151	WEVR1412SLST	R 1/4	12	100	25.0	23.0	19	17

Male elbow, conical male thread acc. to ISO 7-1, light type

Art. No.	Type No.	Thread	Tube O.D. mm	PN bar	L1 mm	L2 mm	a/f 1 mm	a/f 2 mm
112169	V 90	R 1/8	6	315	27.0	20.0	14	12
112171	V 92	R 1/4	6	315	29.0	26.0	14	12
112170	V 91	R 1/8	8	315	29.0	26.0	17	12
112172	V 93	R 1/4	8	315	29.0	26.0	17	12
112175	V 97	R 3/8	8	315	32.0	28.0	17	17
112173	V 94	R 1/4	10	315	30.0	27.0	19	14
112176	V 98	R 3/8	10	315	32.0	28.0	19	17
112179	V 101	R 1/2	10	315	36.0	34.0	19	19
112174	V 95	R 1/4	12	315	32.0	28.0	22	17
112177	V 99	R 3/8	12	315	32.0	28.0	22	17
112180	V 102	R 1/2	12	315	36.0	34.0	22	19
112178	V 100	R 3/8	15	315	36.0	34.0	27	19
112181	V 103	R 1/2	15	315	36.0	34.0	27	19
112182	V 104	R 1/2	18	315	40.0	36.0	32	24
112183	V 106	R 3/4	22	160	44.0	42.0	36	27
159152	WEV128LST	R 1	28	160	47.0	48.0	41	36



V 93

Male elbow, conical male thread acc. to ISO 7-1, heavy type

Art. No.	Type No.	Thread	Tube O.D. mm	PN bar	L1 mm	L2 mm	a/f 1 mm	a/f 2 mm
159153	WEVR146SST	R 1/4	6	630	31.0	26.0	17	12
159154	WEVR148SST	R 1/4	8	630	32.0	27.0	19	14
159155	WEVR3810SST	R 3/8	10	630	34.0	28.0	22	17
159156	WEVR3812SST	R 3/8	12	630	38.0	31.0	24	17
159157	WEVR1212SST	R 1/2	12	630	36.0	34.0	27	19



WEVR3420SST



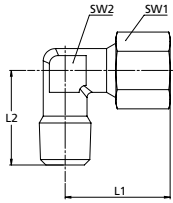

Male elbows

galvanised steel acc. DIN 2353



Male elbow, conical male thread acc. to ISO 7-1, heavy type

Art. No.	Type No.	Thread	Tube O.D. mm	PN bar	L1 mm	L2 mm	a/f 1 mm	a/f 2 mm
159158	WEVR1214SST	R 1/2	14	630	40.0	32.0	27	19
159159	WEVR3816SST	R 3/8	16	400	43.0	32.0	30	24
159160	WEVR1216SST	R 1/2	16	400	43.0	32.0	30	24
159161	WEVR1220SST	R 1/2	20	400	48.0	42.0	36	27
159162	WEVR3420SST	R 3/4	20	400	48.0	42.0	36	27
159163	WEVR125SST	R 1	25	400	54.0	48.0	46	36

Male elbow, NPT thread, very light type

Art. No.	Type No.	Thread	Tube O.D. mm	PN bar	L1 mm	L2 mm	a/f 1 mm	a/f 2 mm
159164	WEV184SLSTNPT	NPT 1/8	4	100	21.0	17.0	10	9
159165	WEV185SLSTNPT	NPT 1/8	5	100	21.0	17.0	12	9
159166	WEV186SLSTNPT	NPT 1/8	6	100	21.0	17.0	12	9
159167	WEV188SLSTNPT	NPT 1/8	8	100	23.0	20.0	14	12



WEV184SLSTNPT



WEV186SLSTNPT

Male elbow, NPT thread, light type

Art. No.	Type No.	Thread	Tube O.D. mm	PN bar	L1 mm	L2 mm	a/f 1 mm	a/f 2 mm
159168	WEV186LSTNPT	NPT 1/8	6	315	27.0	20.0	14	12
159169	WEV146LSTNPT	NPT 1/4	6	315	29.0	26.0	14	12
159170	WEV148LSTNPT	NPT 1/4	8	315	29.0	26.0	17	12
159171	WEV388LSTNPT	NPT 3/8	8	315	32.0	28.0	17	17
159172	WEV1410LSTNPT	NPT 1/4	10	315	30.0	27.0	19	14
159173	WEV3810LSTNPT	NPT 3/8	10	315	32.0	28.0	19	17
159174	WEV1412LSTNPT	NPT 1/4	12	315	32.0	28.0	22	17
159175	WEV3812LSTNPT	NPT 3/8	12	315	32.0	28.0	22	17
159176	WEV1212LSTNPT	NPT 1/2	12	315	36.0	34.0	22	19
159177	WEV1215LSTNPT	NPT 1/2	15	315	36.0	34.0	27	19
159178	WEV1218LSTNPT	NPT 1/2	18	315	40.0	36.0	32	24
159179	WEV3422LSTNPT	NPT 3/4	22	160	44.0	42.0	36	27
159180	WEV128LSTNPT	NPT 1	28	160	47.0	48.0	41	36



WEV146SSTNPT

Male elbow, NPT thread, heavy type

Art. No.	Type No.	Thread	Tube O.D. mm	PN bar	L1 mm	L2 mm	a/f 1 mm	a/f 2 mm
159181	WEV146SSTNPT	NPT 1/4	6	630	31.0	26.0	17	12
159182	WEV148SSTNPT	NPT 1/4	8	630	32.0	27.0	19	14
159183	WEV3810SSTNPT	NPT 3/8	10	630	34.0	28.0	22	17
159184	WEV3812SSTNPT	NPT 3/8	12	630	38.0	31.0	24	17
159185	WEV1212SSTNPT	NPT 1/2	12	630	36.0	34.0	27	19
159186	WEV1214SSTNPT	NPT 1/2	14	630	40.0	32.0	27	19
159187	WEV1216SSTNPT	NPT 1/2	16	630	43.0	36.0	30	24
159188	WEV3420SSTNPT	NPT 3/4	20	400	48.0	42.0	36	27
159189	WEV125SSTNPT	NPT 1	25	400	54.0	48.0	46	36

Union elbows

galvanised steel acc. DIN 2353

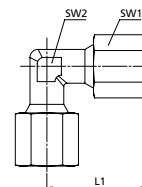

WV10SLST

Union elbow, very light type						
Art. No.	Type No.	Tube O.D. mm	PN bar	L1 mm	a/f 1 mm	a/f 2 mm
112154	V 70	4	100	21.0	10	9
112155	V 71	5	100	21.0	12	9
112156	V 72	6	100	21.0	12	9
112157	V 73	8	100	23.0	14	12
159739	WV10SLST	10	100	27.0	17	14
159740	WV12SLST	12	100	25.0	19	17

Union elbow, light type						
Art. No.	Type No.	Tube O.D. mm	PN bar	L1 mm	a/f 1 mm	a/f 2 mm
112158	V 74	6	315	27.0	14	12
112159	V 75	8	315	29.0	17	12
112160	V 76	10	315	30.0	19	14
112161	V 77	12	315	32.0	22	17
112162	V 78	15	315	36.0	27	19
112163	V 79	18	315	40.0	32	24
112164	V 80	22	160	44.0	36	27
159699	WV28LST	28	160	47.0	41	36



V 75

Union elbow, heavy type						
Art. No.	Type No.	Tube O.D. mm	PN bar	L1 mm	a/f 1 mm	a/f 2 mm
159700	WV6SST	6	630	31.0	17	12
159701	WV8SST	8	630	32.0	19	14
159702	WV10SST	10	630	34.0	22	17
159703	WV12SST	12	630	38.0	24	17
159704	WV14SST	14	630	40.0	27	19
159705	WV16SST	16	400	43.0	30	24
159706	WV20SST	20	400	48.0	36	27
159707	WV25SST	25	400	54.0	46	36



WV6SST

Male branch tees

galvanised steel acc. DIN 2353

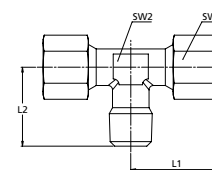

V 113

Male branch tee, conical male thread acc. to ISO 7-1, very light type								
Art. No.	Type No.	Thread	Tube O.D. mm	PN bar	L1 mm	L2 mm	a/f 1 mm	a/f 2 mm
112184	V 110	R 1/8	4	100	21.0	17.0	10	9
112185	V 112	R 1/8	6	100	21.0	17.0	12	9
112186	V 113	R 1/8	8	100	23.0	20.0	14	12

Male branch tee, conical male thread acc. to ISO 7-1, light type								
Art. No.	Type No.	Thread	Tube O.D. mm	PN bar	L1 mm	L2 mm	a/f 1 mm	a/f 2 mm
112188	V 117	R 1/4	8	315	29.0	26.0	17	12
112189	V 118	R 1/4	10	315	30.0	27.0	19	14
112190	V 121	R 3/8	12	315	32.0	28.0	22	17
112191	V 125	R 1/2	15	315	36.0	34.0	27	19
112192	V 126	R 1/2	18	315	40.0	36.0	32	24
112193	V 127	R 3/4	22	160	44.0	42.0	36	27



V 117

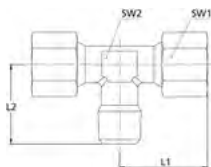

TVR148SST

Male branch tees

galvanised steel acc. DIN 2353



Male branch tee, conical male thread acc. to ISO 7-1, heavy type

Art. No.	Type No.	Thread	Tube O.D. mm	PN bar	L1 mm	L2 mm	a/f 1 mm	a/f 2 mm
112187	V 116	R 1/4	6	630	31.0	26.0	17	12
159206	TVR148SST	R 1/4	8	630	32.0	27.0	19	14
159207	TVR3810SST	R 3/8	10	630	34.0	28.0	22	17
159208	TVR3812SST	R 3/8	12	630	38.0	31.0	24	17
159209	TVR1214SST	R 1/2	14	630	40.0	32.0	27	19
159210	TVR1216SST	R 1/2	16	400	43.0	32.0	30	24
159211	TVR3420SST	R 3/4	20	400	48.0	42.0	36	27
159212	TVR125SST	R 1	25	400	54.0	48.0	46	36

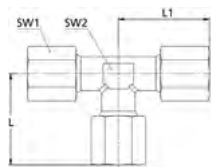

TV10SLST

Branch tees

galvanised steel acc. DIN 2353



Branch tee, very light type

Art. No.	Type No.	Tube O.D. mm	PN bar	L1 mm	a/f 1 mm	a/f 2 mm
112194	V 130	4	100	21.0	10	9
112195	V 131	5	100	21.0	12	9
112196	V 132	6	100	21.0	12	9
112197	V 133	8	100	23.0	14	12
159213	TV10SLST	10	100	27.0	17	14
159214	TV12SLST	12	100	25.0	19	17

Branch tee, light type

Art. No.	Type No.	Tube O.D. mm	PN bar	L1 mm	a/f 1 mm	a/f 2 mm
112198	V 135	6	315	27.0	14	12
112199	V 136	8	315	29.0	17	12
112200	V 137	10	315	30.0	19	14
112201	V 138	12	315	32.0	22	17
112202	V 139	15	315	36.0	27	19
112203	V 140	18	315	40.0	32	24
112204	V 141	22	160	44.0	36	27
159215	TV28LST	28	160	47.0	41	36



V 136

Branch tee, heavy type

Art. No.	Type No.	Tube O.D. mm	PN bar	L1 mm	a/f 1 mm	a/f 2 mm
159216	TV6SST	6	630	31.0	17	12
159217	TV8SST	8	630	32.0	19	14
159218	TV10SST	10	630	34.0	22	17
159219	TV12SST	12	630	38.0	24	17
159220	TV14SST	14	630	40.0	27	19
159221	TV16SST	16	400	43.0	30	24
159222	TV20SST	20	400	48.0	36	27
159223	TV25SST	25	400	54.0	46	36



TV6SST

Ferrules

galvanised steel acc. DIN 2353

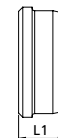

Ferrule, very light type				
Art. No.	Type No.	Tube O.D. mm	PN bar	L1 mm
112227	V 350	4	100	6.0
112228	V 351	5	100	7.0
112229	V 352	6	100	7.0
112230	V 353	8	100	7.0
159348	SR10SLST	10	100	7.0
159349	SR12SLST	12	100	7.5



V 353



SR10SLST



SR28LST

Ferrule, light type				
Art. No.	Type No.	Tube O.D. mm	PN bar	L1 mm
112231	V 360	6	315	9.0
112232	V 361	8	315	9.0
112233	V 362	10	315	10.0
112234	V 363	12	315	10.0
112235	V 364	15	315	10.0
112236	V 365	18	315	10.0
112237	V 366	22	160	11.0
159350	SR28LST	28	160	11.0



SR10SST

Ferrule, heavy type				
Art. No.	Type No.	Tube O.D. mm	PN bar	L1 mm
159351	SR6SST	6	630	9.5
159352	SR8SST	8	630	9.5
159353	SR10SST	10	630	10.0
159354	SR12SST	12	630	10.0
159355	SR14SST	14	630	10.0
159356	SR16SST	16	400	10.5
159357	SR20SST	20	400	13.0
159358	SR25SST	25	400	13.0

Swivel nuts

galvanised steel acc. DIN 2353

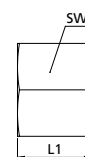

Swivel nut, very light type						
Art. No.	Type No.	Thread	Tube O.D. mm	PN bar	L1 mm	a/f 1 mm
112238	V 400	M8x1.0	4	100	11.0	10
112239	V 401	M10x1.0	5	100	11.0	12
112240	V 402	M10x1.0	6	100	11.0	12
112241	V 403	M12x1.0	8	100	12.0	14
159359	UE10SLST	M14x1.0	10	100	12.5	17
159360	UE12SLST	M16x1.0	12	100	13.0	19



V 403



UE10SLST



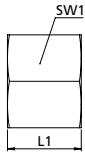

Swivel nuts

galvanised steel acc. DIN 2353



UE28LST



UE6SST

Swivel nut, light type

Art. No.	Type No.	Thread	Tube O.D. mm	PN bar	L1 mm	a/f 1 mm
112242	V 405	M12x1.5	6	315	14.0	14
112243	V 406	M14x1.5	8	315	14.0	17
112244	V 407	M16x1.5	10	315	15.0	19
112245	V 408	M18x1.5	12	315	15.0	22
112246	V 409	M22x1.5	15	315	17.0	27
112247	V 410	M26x1.5	18	315	18.0	32
112248	V 411	M30x2.0	22	160	20.0	36
159361	UE28LST	M36x2.0	28	160	21.0	41

Swivel nut, heavy type

Art. No.	Type No.	Thread	Tube O.D. mm	PN bar	L1 mm	a/f 1 mm
159362	UE6SST	M14x1.5	6	630	16.5	17
159363	UE8SST	M16x1.5	8	630	16.5	19
159364	UE10SST	M18x1.5	10	630	17.5	22
159365	UE12SST	M20x1.5	12	630	17.5	24
159366	UE14SST	M22x1.5	14	630	20.5	27
159367	UE16SST	M24x1.5	16	400	20.5	30
159368	UE20SST	M30x2.0	20	400	24.0	36
159369	UE25SST	M36x2.0	25	400	27.0	46

Bite-type tube fittings

stainless steel 1.4571 (DIN 2353)

Version with parallel thread and soft seal made of NBR.

Material	Stainless steel 1.4571 (DIN 2353)
----------	-----------------------------------

Male connectors

stainless steel 1.4571 (DIN 2353)

Male connector, parallel thread and soft seal

Art. No.	Type No.	Thread	Tube O.D. mm	PN bar	L1 mm	L2 mm
112281	ES 21-ZW	G 1/8	4	100	29.0	8.0
112282	ES 23-ZW	G 1/8	6	100	30.0	8.0
112283	ES 24-ZW	G 1/8	8	100	31.0	8.0
112284	ES 25-ZW	G 1/8	6	315	31.0	8.0
112285	ES 26-ZW	G 1/8	8	315	31.5	8.0
112286	ES 28-ZW	G 1/4	6	315	36.5	12.0
112287	ES 29-ZW	G 1/4	8	315	37.0	12.0
112288	ES 30-ZW	G 1/4	10	315	38.0	12.0
112289	ES 31-ZW	G 1/4	12	315	38.0	12.0
112290	ES 33-ZW	G 3/8	6	315	38.0	12.0
112291	ES 34-ZW	G 3/8	8	315	38.0	12.0
112292	ES 35-ZW	G 3/8	10	315	39.5	12.0
112293	ES 36-ZW	G 3/8	12	315	39.5	12.0
112294	ES 37-ZW	G 3/8	15	315	40.5	12.0
112295	ES 38-ZW	G 1/2	8	315	40.5	14.0
112296	ES 39-ZW	G 1/2	10	315	43.0	14.0
112297	ES 40-ZW	G 1/2	12	315	42.0	14.0
112298	ES 41-ZW	G 1/2	15	315	43.0	14.0
112299	ES 42-ZW	G 1/2	18	315	45.0	14.0
112300	ES 43-ZW	G 3/4	18	315	47.0	16.0
112301	ES 44-ZW	G 3/4	22	160	49.0	16.0

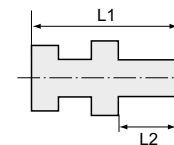

ES 28-ZW

Reducing adapters

stainless steel 1.4571 (DIN 2353)

Long reducing adapter, parallel thread and soft seal

Art. No.	Type No.	Male thread	Female thread	PN bar	L1 mm	L2 mm
112302	ES 300-ZW	G 1/4	G 1/8	400	28.0	12.0
112303	ES 301-ZW	G 3/8	G 1/4	400	36.0	12.0
112304	ES 302-ZW	G 1/2	G 3/8	400	37.0	14.0
112305	ES 303-ZW	G 3/4	G 1/2	315	41.0	16.0

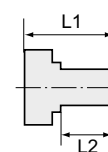

ES 302-ZW

Short reducing adapter, parallel thread and soft seal

Art. No.	Type No.	Male thread	Female thread	PN bar	L1 mm	L2 mm
112306	ES 310-ZW	G 3/8	G 1/8	400	22.5	12.0
112307	ES 311-ZW	G 1/2	G 1/4	400	24.0	14.0
112308	ES 312-ZW	G 3/4	G 1/4	315	26.0	16.0
112309	ES 313-ZW	G 3/4	G 3/8	315	26.0	16.0
112310	ES 314-ZW	G 1	G 1/2	315	29.0	18.0



ES 311-ZW

Adjustable bite-type tube fittings

stainless steel 1.4571 (DIN 2353)

Version with parallel thread and soft seal made of NBR.

Material Stainless steel 1.4571 (DIN 2353)

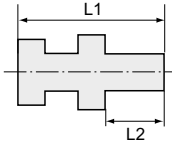

ES 504

Adjustable male connectors

stainless steel 1.4571 (DIN 2353)

Adjustable male connector with cone seal

Art. No.	Type No.	Female nut thread	Thread	Tube O.D. mm	PN bar	L1 mm	L2 mm
112311	ES 501	M12x1.5	G 1/8	6	315	32.5	8.0
112312	ES 502	M14x1.5	G 1/4	8	315	41.5	12.0
112313	ES 503	M16x1.5	G 1/4	10	315	39.5	12.0
112314	ES 504	M18x1.5	G 3/8	12	315	46.0	12.0
112315	ES 505	M22x1.5	G 1/2	15	315	46.0	14.0
112316	ES 506	M26x1.5	G 1/2	18	315	45.5	14.0
112317	ES 507	M30x2.0	G 3/4	22	160	48.5	16.0

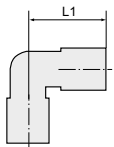

ES 514

Adjustable union elbows

stainless steel 1.4571 (DIN 2353)

Adjustable union elbow with cone seal

Art. No.	Type No.	Female nut thread	Tube O.D. mm	PN bar	L1 mm
112318	ES 511	M12 x 1.5	6	315	27.0
112319	ES 512	M14 x 1.5	8	315	29.0
112320	ES 513	M16 x 1.5	10	315	30.0
112321	ES 514	M18 x 1.5	12	315	32.0
112322	ES 515	M22 x 1.5	15	315	36.0
112323	ES 516	M26 x 1.5	18	315	40.0
112324	ES 517	M30 x 2.0	22	160	44.0

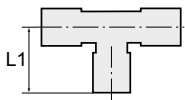

ES 524

Adjustable run tees

stainless steel 1.4571 (DIN 2353)

Adjustable run tee with cone seal

Art. No.	Type No.	Female nut thread	Tube O.D. mm	PN bar	L1 mm
112325	ES 521	M12x1.5	6	315	27.0
112326	ES 522	M14x1.5	8	315	29.0
112327	ES 523	M16x1.5	10	315	30.0
112328	ES 524	M18x1.5	12	315	32.0
112329	ES 525	M22x1.5	15	315	36.0
112330	ES 526	M26x1.5	18	315	40.0
112331	ES 527	M30x2.0	22	160	44.0

Adjustable unions

stainless steel 1.4571 (DIN 2353)



ES 534

Adjustable union with cone seal

Art. No.	Type No.	Female nut thread	Tube O.D. mm	PN bar	L1 mm
112332	ES 531	M12x1.5	6	315	38.0
112333	ES 532	M14x1.5	8	315	39.0
112334	ES 533	M16x1.5	10	315	40.0
112335	ES 534	M18x1.5	12	315	40.0
112336	ES 535	M22x1.5	15	315	43.0
112337	ES 536	M26x1.5	18	315	44.5
112338	ES 537	M30x2.0	22	160	49.0

Adjustable branch tees

stainless steel 1.4571 (DIN 2353)

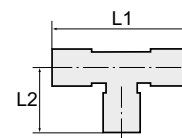

ES 544

Adjustable branch tee with cone seal

Art. No.	Type No.	Female nut thread	Tube O.D. mm	PN bar	L1 mm	L2 mm
112339	ES 541	M12x1.5	6	315	54.0	26.0
112340	ES 542	M14x1.5	8	315	58.0	27.5
112341	ES 543	M16x1.5	10	315	60.0	29.0
112342	ES 544	M18x1.5	12	315	64.0	29.5
112343	ES 545	M22x1.5	15	315	72.0	32.5
112344	ES 546	M26x1.5	18	315	80.0	35.5
112345	ES 547	M30x2.0	22	160	88.0	38.5

Reducing fittings with cone seal

stainless steel 1.4571 (DIN 2353)



ES 562

Reducing fitting with cone seal

Art. No.	Type No.	Female nut thread Ø 1	Tube O.D. 1 mm	Tube O.D. 2 mm	PN bar	L1 mm
112346	ES 551	M 14 x 1.5	8	6	315	39.5
112347	ES 552	M 16 x 1.5	10	6	315	39.5
112348	ES 553	M18x1.5	12	6	315	39.5
112349	ES 554	M22x1.5	15	6	315	43.5
112350	ES 555	M26x1.5	18	6	315	44.0
112351	ES 556	M30x2.0	22	6	160	45.0
112352	ES 557	M16x1.5	10	8	315	40.0
112353	ES 558	M18x1.5	12	8	315	40.0
112354	ES 559	M22x1.5	15	8	315	44.0
112355	ES 560	M26x1.5	18	8	315	44.5
112356	ES 561	M30x2.0	22	8	160	45.5
112357	ES 562	M18x1.5	12	10	315	41.0
112358	ES 563	M22x1.5	15	10	315	45.0
112359	ES 564	M26x1.5	18	10	315	45.5
112360	ES 565	M30x2.0	22	10	160	46.5
112361	ES 566	M22x1.5	15	12	315	44.5
112362	ES 567	M26x1.5	18	12	315	45.0



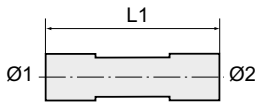

Reducing fittings with cone seal

stainless steel 1.4571 (DIN 2353)



ES 562

Reducing fitting with cone seal

Art. No.	Type No.	Female nut thread Ø 1	Tube O.D. 1 mm	Tube O.D. 2 mm	PN bar	L1 mm
112363	ES 568	M30x2.0	22	12	160	46.0
112364	ES 569	M26x1.5	18	15	315	46.5
112365	ES 570	M30x2.0	22	15	160	46.5
112366	ES 571	M30x2.0	22	18	160	48.5

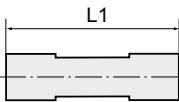

Pressure gauge fittings

stainless steel 1.4571 (DIN 2353)



ES 584

Pressure gauge fitting with cone seal, female thread

Art. No.	Type No.	Thread	Female nut thread	Tube O.D. mm	PN bar	L1 mm
112367	ES 581	G 1/4	M12x1.5	6	315	35.5
112368	ES 582	G 1/4	M14x1.5	8	315	37.5
112369	ES 583	G 1/4	M16x1.5	10	315	36.0
112370	ES 584	G 1/4	M18x1.5	12	315	36.0

Bite-type tube fittings

standard - stainless steel 1.4571 - (DIN 2353)

Material	Stainless steel 1.4571 (DIN 2353)
Version	Standard

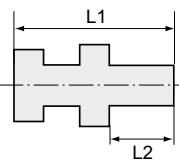

Male connectors

standard - stainless steel 1.4571 - (DIN 2353)



ES 35

Male connector, thread acc. to ISO 7-1

Art. No.	Type No.	Thread	Tube O.D. mm	PN bar	L1 mm	L2 mm
112371	ES 21	R 1/8	4	100	25.5	8.0
112372	ES 23	R 1/8	6	100	26.0	8.0
112373	ES 24	R 1/8	8	100	28.0	8.0
112374	ES 25	R 1/8	6	315	30.5	8.0
112375	ES 26	R 1/8	8	315	34.2	8.0
112376	ES 28	R 1/4	6	315	34.5	12.0
112377	ES 29	R 1/4	8	315	35.0	12.0
112378	ES 30	R 1/4	10	315	36.0	12.0
112379	ES 31	R 1/4	12	315	40.6	12.0
112380	ES 33	R 3/8	6	315	38.5	12.0
112381	ES 34	R 3/8	8	315	39.2	12.0
112382	ES 35	R 3/8	10	315	36.0	12.0
112383	ES 36	R 3/8	12	315	37.0	12.0
112384	ES 37	R 3/8	15	315	42.3	12.0
112385	ES 38	R 1/2	8	315	42.2	14.0

Male connectors

standard - stainless steel 1.4571 - (DIN 2353)

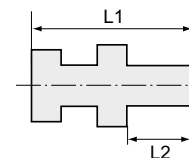

ES 35

Male connector, thread acc. to ISO 7-1						
Art. No.	Type No.	Thread	Tube O.D. mm	PN bar	L1 mm	L2 mm
112386	ES 39	R 1/2	10	315	42.8	14.0
112387	ES 40	R 1/2	12	315	39.0	14.0
112388	ES 41	R 1/2	15	315	40.0	14.0
112389	ES 42	R 1/2	18	315	42.0	14.0
112390	ES 43	R 3/4	18	315	49.2	16.0
112391	ES 44	R 3/4	22	160	46.0	16.0

Unions

standard - stainless steel 1.4571 - (DIN 2353)

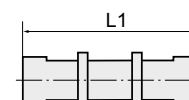

ES 55

Union					
Art. No.	Type No.	Tube O.D. mm	PN bar	L1 mm	
112392	ES 50	4	100	31.0	
112393	ES 52	6	100	32.0	
112394	ES 53	8	100	35.0	
112395	ES 54	6	315	39.0	
112396	ES 55	8	315	40.0	
112397	ES 56	10	315	42.0	
112398	ES 57	12	315	43.0	
112399	ES 58	15	315	46.0	
112400	ES 59	18	315	48.0	
112401	ES 60	22	160	52.0	

Union elbows

standard - stainless steel 1.4571 - (DIN 2353)

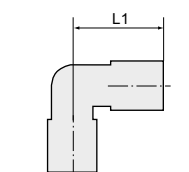

ES 75

Union elbow					
Art. No.	Type No.	Tube O.D. mm	PN bar	L1 mm	
112402	ES 70	4	100	21.0	
112403	ES 72	6	100	21.0	
112404	ES 73	8	100	23.0	
112405	ES 74	6	315	27.0	
112406	ES 75	8	315	29.0	
112407	ES 76	10	315	30.0	
112408	ES 77	12	315	32.0	
112409	ES 78	15	315	36.0	
112410	ES 79	18	315	40.0	

Bite-type tube fittings

stainless steel 1.4571

Material Stainless steel 1.4571

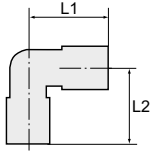

Male elbows

stainless steel 1.4571



ES 93

Male elbow, conical male thread acc. to ISO 7-1

Art. No.	Type No.	Thread	Tube O.D. mm	PN bar	L1 mm	L2 mm
112411	ES 85	R 1/8	4	100	21.0	17.0
112412	ES 87	R 1/8	6	100	21.0	17.0
112413	ES 88	R 1/8	8	100	23.0	20.0
112414	ES 90	R 1/8	6	315	26.5	20.0
112415	ES 91	R 1/8	8	315	28.5	24.0
112416	ES 92	R 1/4	6	315	26.5	24.0
112417	ES 93	R 1/4	8	315	28.5	26.0
112418	ES 94	R 1/4	10	315	29.5	27.0
112419	ES 95	R 1/4	12	315	32.0	28.0
112420	ES 96	R 3/8	6	630	32.5	27.0
112421	ES 97	R 3/8	8	315	29.5	27.0
112422	ES 98	R 3/8	10	315	29.5	28.0
112423	ES 99	R 3/8	12	315	32.0	28.0
112424	ES 100	R 3/8	15	315	40.3	32.0
112425	ES 101	R 1/2	10	315	29.5	31.0
112426	ES 102	R 1/2	12	315	36.0	32.0
112427	ES 103	R 1/2	15	315	36.0	34.0
112428	ES 104	R 1/2	18	315	44.2	36.0

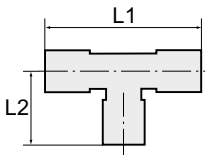

Male branch tees

stainless steel 1.4571



ES 117

Male branch tee, conical male thread acc. to ISO 7-1

Art. No.	Type No.	Thread	Tube O.D. mm	PN bar	L1 mm	L2 mm
112429	ES 110	R 1/8	4	100	42.0	17.0
112430	ES 112	R 1/8	6	315	54.0	20.0
112431	ES 113	R 1/8	8	100	64.0	24.0
112432	ES 116	R 1/4	6	315	60.0	24.0
112433	ES 117	R 1/4	8	315	58.0	26.0
112434	ES 118	R 1/4	10	315	60.0	27.0

Branch tees

stainless steel 1.4571

Branch tee

Art. No.	Type No.	Tube O.D. mm	PN bar	L1 mm
112435	ES 132	6	100	21.0
112436	ES 133	8	100	23.0
112437	ES 135	6	315	27.0
112438	ES 136	8	315	29.0
112439	ES 137	10	315	30.0
112440	ES 138	12	315	32.0
112441	ES 139	15	315	36.0
112442	ES 140	18	315	40.0

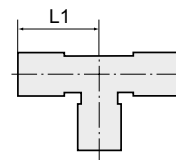

ES 136

Bulkhead connectors

stainless steel 1.4571

Bulkhead connector

Art. No.	Type No.	Tube O.D. mm	PN bar	L1 mm
112443	ES 170	6	315	64.0
112444	ES 171	8	315	65.0
112445	ES 172	10	315	68.0
112446	ES 173	12	315	69.0
112447	ES 174	15	315	73.0
112448	ES 175	18	315	79.0
112449	ES 176	22	160	84.0

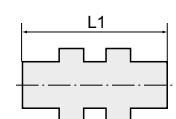

ES 171

Bulkhead elbow connectors

stainless steel 1.4571

Bulkhead elbow connector

Art. No.	Type No.	Tube O.D. mm	PN bar	L1 mm	L2 mm
112450	ES 180	6	315	56.0	27.0
112451	ES 181	8	315	59.0	29.0
112452	ES 182	10	315	61.0	30.0
112453	ES 183	12	315	64.0	32.0
112454	ES 184	15	315	69.0	36.0
112455	ES 185	18	315	73.0	40.0
112456	ES 186	22	160	81.0	44.0

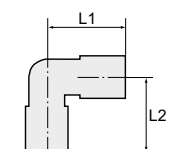

ES 181



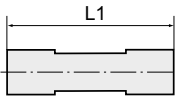

Pressure gauge fittings

stainless steel 1.4571



ES 201

Pressure gauge fitting, parallel female thread

Art. No.	Type No.	Thread	Tube O.D. mm	PN bar	L1 mm
112457	ES 200	G 1/4	6	315	37.0
112458	ES 201	G 1/4	8	315	37.0
112459	ES 202	G 1/4	10	315	38.0
112460	ES 203	G 1/4	12	315	38.0
112461	ES 205	G 1/2	6	630	46.0
112462	ES 206	G 1/2	8	630	46.0
112463	ES 207	G 1/2	10	630	47.0
112464	ES 208	G 1/2	12	630	47.0

Ferrules

stainless steel 1.4571



ES 361

Ferrule

Art. No.	Type No.	Tube O.D. mm	PN bar	L1 mm
112465	ES 350	4	100	6.0
112466	ES 352	6	100	7.0
112467	ES 353	8	100	7.0
112468	ES 360	6	630	9.5
112469	ES 361	8	630	9.5
112470	ES 362	10	630	10.0
112471	ES 363	12	630	10.0
112472	ES 364	15	315	10.0
112473	ES 365	18	315	10.5
112474	ES 366	22	160	10.5

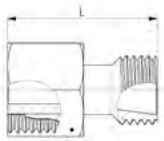

SW

Reducers

stainless steel 1.4571



ES 212

Reducer

Art. No.	Type No.	Female connector Ø mm	PN bar	L mm	a/f mm
112475	ES 210	8/6	315	38.0	17
112476	ES 211	10/6	315	38.0	19
112477	ES 212	10/8	315	38.0	19
112478	ES 213	12/6	315	38.0	22
112479	ES 214	12/8	315	38.0	22
112480	ES 215	12/10	315	39.0	22
112481	ES 216	15/6	315	38.0	27
112482	ES 217	15/8	315	38.0	27
112483	ES 218	15/10	315	39.0	27
112484	ES 219	15/12	315	39.0	27
112485	ES 220	18/6	315	39.0	32
112486	ES 221	18/8	315	39.0	32
112487	ES 222	18/10	315	40.0	32

Reducers

stainless steel 1.4571

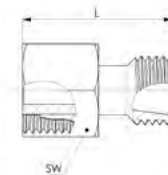

Reducer						
Art. No.	Type No.	Female connector Ø mm	PN bar	L mm	a/f mm	
112488	ES 223	18/12	315	40.0	32	
112489	ES 224	18/15	315	42.0	32	

Reducing adapters

stainless steel 1.4571

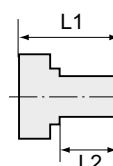

Long reducing adapter						
Art. No.	Type No.	Male thread	Female thread	PN bar	L1 mm	L2 mm
112490	ES 300	G 1/4	G 1/8	400	28.0	12.0
112491	ES 301	G 3/8	G 1/4	400	36.0	12.0
112492	ES 302	G 1/2	G 3/8	400	36.0	14.0
112493	ES 303	G 3/4	G 1/2	400	41.0	16.0



ES 301

Short reducing adapter						
Art. No.	Type No.	Male thread	Female thread	PN bar	L1 mm	L2 mm
112494	ES 310	G 3/8	G 1/8	400	22.5	12.0
112495	ES 311	G 1/2	G 1/4	400	24.0	14.0
112496	ES 312	G 3/4	G 1/4	315	26.0	16.0
112497	ES 313	G 3/4	G 3/8	315	26.0	16.0
112498	ES 314	G 1	G 1/2	315	29.0	18.0
112499	ES 315	G 1 1/4	G 3/4	250	32.0	20.0
112500	ES 316	G 1 1/2	G 3/4	250	36.0	22.0
112501	ES 317	G 1 1/2	G 1	250	36.0	22.0



ES 311

Swivel nuts

stainless steel 1.4571

Swivel nut						
Art. No.	Type No.	Thread	Tube O.D. mm	PN bar	L1 mm	
112502	ES 400	M8x1.0	4	100	11.0	
112503	ES 402	M10x1.0	6	100	11.5	
112504	ES 403	M12x1.0	8	100	12.0	
112505	ES 405	M12x1.5	6	315	14.5	
112506	ES 406	M14x1.5	8	315	14.5	
112507	ES 407	M16x1.5	10	315	15.5	
112508	ES 408	M18x1.5	12	315	15.5	
112509	ES 409	M22x1.5	15	315	17.0	
112510	ES 410	M26x1.5	18	315	18.0	
112511	ES 411	M30x2.0	22	160	20.0	



ES 406



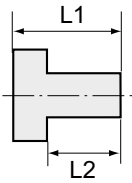

Pre-assembly adapters

When stainless steel pipes are assembled, they must always be pre-assembled in a hardened pre-assembly adapter. They must never be assembled directly in the stainless steel adapter. The cones of the pre-assembly adapters are susceptible to wear and must therefore be inspected at regular intervals to check that they are still true to gauge.

We recommend using only seamless, soft-annealed, stainless steel pipes made of 1.4571 according to DIN 2391 Part 1 or DIN 2462, tolerance class D4/T3.



VMS 05

Pre-assembly adapters for stainless steel cutting ring fitting

Art. No.	Type No.	Tube O.D. mm	Thread	PN bar	L1 mm	L2 mm	a/f mm
112512	VMS 01	4	M8x1.0	100	25.0	8.0	10
112513	VMS 02	6	M10x1.0	100	25.0	8.0	10
112514	VMS 03	8	M12x1.0	100	26.0	9.0	12
112515	VMS 04	6	M12x1.5	315	35.0	15.0	12
112516	VMS 05	8	M14x1.5	315	36.0	15.0	12
112517	VMS 06	10	M16x1.5	315	40.0	15.0	17
112518	VMS 07	12	M18x1.5	315	40.0	15.0	17
112519	VMS 08	15	M22x1.5	315	42.0	15.0	19
112520	VMS 09	18	M26x1.5	315	45.0	15.0	22
112521	VMS 10	22	M30x2.0	315	50.0	20.0	24



GP 100



GP 250

Lubricant

For assembling bite-type tube fittings with steel or stainless steel pipes.

Significantly reduced torques.

No thread seizure: cold welding of stainless steel threads is ruled out.

Silicone-free, food grade.

Lubricant

Art. No.	Type No.	Contents g
112522	GP 100	Tube 100
112523	GP 250	Tin 250

Distributor blocks

with integrated ball valves

PLUS

Distributor and isolator block for machines and installations where it is necessary to close individual circuits. This block contains 6, 8 or 10 ball valves that can be adjusted using a screwdriver.

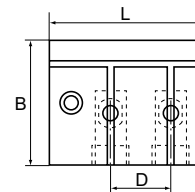

Housing	Die-cast aluminium
Ball	Ms 58, chrome-plated
Stem	Ms 58, chrome-plated
Ball seal	PTFE
O-ring	NBR
Temperature range	-10 to 100 °C
Max. operating pressure	10 bar
Applications	Air, rough vacuum
Mounting	2 mounting holes in housing (screw size M5)
Thread, input	G 3/8
Thread, output	G 3/8
Thread, ball valve ports	G 1/4

Distributor block with integrated ball valves					
Art. No.	Type No.	No. of ball valves	L mm	B mm	D mm
103578	VT 5226	6	175.0	52.0	25.0
103579	VT 5228	8	225.0	52.0	25.0
103580	VT 52210	10	275.0	52.0	25.0



Distributor blocks

aluminium

PLUS

For easy assembly of compressed air taps (screw fittings, unions, couplings, etc.). Optionally with 2, 3, 4, or 6 outlets on one side or both sides.

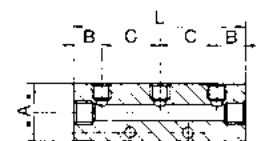

Distributor block, outlets on one side (front)							
Art. No.	Type No.	Input	Output	L mm	A mm	B mm	C mm
112524	VT 15502	2 x 1/8	2 x M5	45.0	20.0	15.0	15.0
112525	VT 15503	2 x 1/8	3 x M5	60.0	20.0	15.0	15.0
112526	VT 15504	2 x 1/8	4 x M5	75.0	20.0	15.0	15.0
112527	VT 15506	2 x 1/8	6 x M5	105.0	20.0	15.0	15.0
112528	VT 15102	2 x 1/4	2 x 1/8	60.0	30.0	15.0	30.0
112529	VT 15103	2 x 1/4	3 x 1/8	90.0	30.0	15.0	30.0
112530	VT 15104	2 x 1/4	4 x 1/8	120.0	30.0	15.0	30.0
112531	VT 15106	2 x 1/4	6 x 1/8	180.0	30.0	15.0	30.0
112532	VT 15202	2 x 3/8	2 x 1/4	72.0	40.0	18.0	36.0
112533	VT 15203	2 x 3/8	3 x 1/4	108.0	30.0	18.0	36.0
112534	VT 15204	2 x 3/8	4 x 1/4	144.0	30.0	18.0	36.0
112535	VT 15206	2 x 3/8	6 x 1/4	216.0	30.0	18.0	36.0
112536	VT 15302	2 x 3/8	2 x 1/8	66.0	40.0	18.0	30.0
112537	VT 15303	2 x 3/8	3 x 1/8	96.0	30.0	18.0	30.0
112538	VT 15304	2 x 3/8	4 x 1/8	126.0	30.0	18.0	30.0
112539	VT 15306	2 x 3/8	6 x 1/8	186.0	30.0	18.0	30.0
112540	VT 15402	2 x 1/2	2 x 1/4	80.0	40.0	22.0	36.0
112541	VT 15403	2 x 1/2	3 x 1/4	116.0	40.0	22.0	36.0
112542	VT 15404	2 x 1/2	4 x 1/4	152.0	40.0	22.0	36.0
112543	VT 15406	2 x 1/2	6 x 1/4	224.0	40.0	22.0	36.0



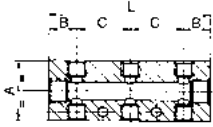

VT 15222

Distributor blocks

aluminium

PLUS

Distributor block, outlets on both sides (front and back)

Art. No.	Type No.	Input	Output	L mm	A mm	B mm	C mm
112544	VT 15522	2 x 1/8	2 + 2 x M5	45.0	20.0	15.0	15.0
112545	VT 15533	2 x 1/8	3 + 3 x M5	60.0	20.0	15.0	15.0
112546	VT 15544	2 x 1/8	4 + 4 x M5	75.0	20.0	15.0	15.0
112547	VT 15566	2 x 1/8	6 + 6 x M5	105.0	20.0	15.0	15.0
112548	VT 15122	2 x 1/4	2 + 2 x 1/8	60.0	30.0	15.0	30.0
112549	VT 15133	2 x 1/4	3 + 3 x 1/8	90.0	30.0	15.0	30.0
112550	VT 15144	2 x 1/4	4 + 4 x 1/8	120.0	30.0	15.0	30.0
112551	VT 15166	2 x 1/4	6 + 6 x 1/8	180.0	30.0	15.0	30.0
112552	VT 15222	2 x 3/8	2 + 2 x 1/4	72.0	40.0	18.0	36.0
112553	VT 15233	2 x 3/8	3 + 3 x 1/4	108.0	40.0	18.0	36.0
112554	VT 15244	2 x 3/8	4 + 4 x 1/4	144.0	40.0	18.0	36.0
112555	VT 15266	2 x 3/8	6 + 6 x 1/4	216.0	40.0	18.0	36.0
112556	VT 15422	2 x 1/2	2 + 2 x 1/4	80.0	40.0	22.0	36.0
112557	VT 15433	2 x 1/2	3 + 3 x 1/4	116.0	40.0	22.0	36.0
112558	VT 15444	2 x 1/2	4 + 4 x 1/4	152.0	40.0	22.0	36.0
112559	VT 15466	2 x 1/2	6 + 6 x 1/4	224.0	40.0	22.0	36.0

Porting boxes

PLUS

Made of plastic PA6 GF 30.

End and through distributor sockets made of high strength, glass fibre reinforced plastic (PA6 GF 30) with large range of applications.

Optionally 1 or up to 3 connection options as well as 2 thread sizes for internal and external threads (cannot be combined). For vertical carrying of media.

Universal distributor socket with up to 5 connection options. Suitable for vertical and/or horizontal carrying of media or the secure connection (avoidance of existing components) of pressure reducer or maintenance device, for example.

All distributor sockets have a durable brass threaded insert, whose shape secures it against rotation and against axial shift due to its shape.

Suitable for media compressed air (ambient temperature -10 °C to 50 °C) or water (ambient temperature 1 °C to 50 °C). Drilling diagram dimensions are identical for all distributor sockets, so a simpler and more flexible exchange between end, through and universal distributor sockets is ensured.

Caution:

Note that the distributor sockets should not be installed in danger zones.

Danger zones are, for example, transport routes, escape routes, etc.



EVD12-1



EVD12-2



EVD12-3

Max. operating pressure	15 bar
Temperature range	1 to 50 °C
Housing	Glass fibre-reinforced plastic PA6 GF 30
Max. tightening torque brass thread	12 Nm
Max. tightening torque mounting holes	4 Nm

End distributor without through-hole thread, PN 15

Art. No.	Type No.	Inlet thread	Connecting thread
112613	EVD12-1	G 1/2	1 x G 1/2
112614	EVD12-2	G 1/2	2 x G 1/2
112615	EVD12-3	G 1/2	3 x G 1/2
112616	EVD34-1	G 3/4	1 x G 1/2
112617	EVD34-2	G 3/4	2 x G 1/2
112618	EVD34-3	G 3/4	3 x G 1/2

Porting boxes

PLUS

Through distributor with through-hole thread, PN 15

Art. No.	Type No.	Inlet thread	Through-hole thread	Connecting thread
112619	DVD12-1	G 1/2	G 1/2	1 x G 1/2
112620	DVD12-2	G 1/2	G 1/2	2 x G 1/2
112621	DVD12-3	G 1/2	G 1/2	3 x G 1/2
112622	DVD34-1	G 3/4	G 3/4	1 x G 1/2
112623	DVD34-2	G 3/4	G 3/4	2 x G 1/2
112624	DVD34-3	G 3/4	G 3/4	3 x G 1/2

Universal distributor with through-hole thread, PN 15

Art. No.	Type No.	Inlet thread	Through-hole thread	Connecting thread
194135 NEW	UVD12-6	G 1/2	G 1/2	6 x G 1/2

- For pre-assembled porting boxes with quick disconnect couplings, refer to page 499
- For pre-assembled porting boxes with pushbutton-type safety couplings, refer to page 535-536



UVD12-6

Distributors, in block shape

made of brass

PLUS

Male L-distributor

Art. No.	Type No.	G 1	G 2	a/f mm	L mm
112578	14.0950	M5	M5	9	13.0
112579	14.0951	G 1/8	G 1/8	17	23.0
112580	14.0952	G 1/4	G 1/4	22	29.0
112581	14.0953	G 3/8	G 3/8	27	32.0

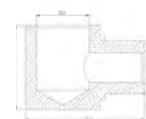

14.0952

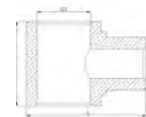

14.0942

Male tee distributor

Art. No.	Type No.	G 1	G 2	a/f mm	L mm
112582	14.0940	M5	M5	10	14.0
112583	14.0941	G 1/8	G 1/8	17	23.0
112584	14.0942	G 1/4	G 1/4	22	29.0
112585	14.0943	G 3/8	G 3/8	27	32.0

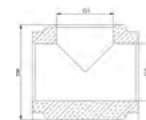

16.0962

Tee distributor

Art. No.	Type No.	G 1	G 2	a/f mm	L mm
112586	16.0960	M5	M5	8	14.0
112587	16.0961	G 1/8	G 1/8	16	23.0
112588	16.0962	G 1/4	G 1/4	22	30.0

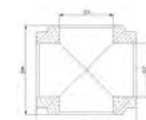

16.0972

X-distributor

Art. No.	Type No.	G 1	G 2	a/f mm	L mm
112591	16.0970	M5	M5	8	14.0
112592	16.0971	G 1/8	G 1/8	16	23.0
112593	16.0972	G 1/4	G 1/4	22	30.0



Distributors, in block shape

made of aluminium

PLUS

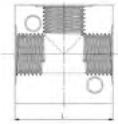

16.0963

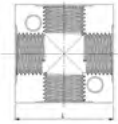

16.0973

Tee distributor, flangeable

Art. No.	Type No.	Thread	a/f mm	L mm
129676 NEW	16.0965	G 1/8	16	25.0
129677 NEW	16.0966	G 1/4	20	40.0
112589	16.0963	G 3/8	25	40.0
112590	16.0964	G 1/2	30	50.0

X-distributor, flangeable

Art. No.	Type No.	Thread	a/f mm	L mm
129678 NEW	16.0975	G 1/8	16	25.0
129679 NEW	16.0976	G 1/4	20	40.0
112594	16.0973	G 3/8	25	40.0
112595	16.0974	G 1/2	30	50.0

Distributor pieces

PLUS

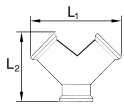

Max. operating pressure 60 bar
Max. temperature range 150 °C



255.012



255.212

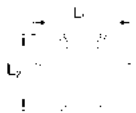
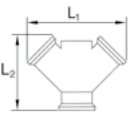

Distributor, 2 outlets, nickel-plated brass

Art. No.	Type No.	Thread	Outlet	L1 mm	L2 mm
112596	255.00	R 1/8 ET	2 x G 1/8 IT	29.0	32.0
112597	255.00/1	R 1/4 ET	2 x G 1/4 IT	36.0	38.0
112598	255.038	R 3/8 ET	2 x G 3/8 IT	41.0	42.5
112599	255.012	R 1/2 ET	2 x G 1/2 IT	53.0	53.0
112600	255.218	G 1/8 IT	2 x G 1/8 IT	29.0	26.5
112601	255.214	G 1/4 IT	2 x G 1/4 IT	36.0	32.0
112602	255.238	G 3/8 IT	2 x G 3/8 IT	41.0	37.0
112603	255.212	G 1/2 IT	2 x G 1/2 IT	53.0	45.0

Distributor, 2 or 3 outlets, brass

Art. No.	Type No.	Thread	Outlet	L1 mm	L2 mm
112604	255.01	G 3/8 IT	2 x G 3/8 IT	53.5	50.0
112605	255.02	G 1/2 IT	2 x G 1/2 IT	58.5	54.0
112606	256.01	G 3/8 IT	3 x G 3/8 IT	76.0	61.0
112607	256.02	G 1/2 IT	3 x G 1/2 IT	87.7	69.0



255.02



256.02



DW 267

Wall plate (wall mountable)

Art. No.	Type No.	Thread
112608	DW 266	2 x G 3/8 IT
112609	DW 267	2 x G 1/2 IT
112610	DW 268	2 x G 3/4 IT



VT 1000

Distributor (wall mountable), 5 x G 1/2 outlets

Art. No.	Type No.	Connection variant
112611	VT 1000	1 outlet each on left and right, on top, bottom and front
112612	VT 1020	1 outlet each on left and right, 3 outlets on front

Distributor pipes

brass



For assembling compressed air taps.

End fittings with 1 x male and 1 x female thread, outlets optionally with male or female thread.

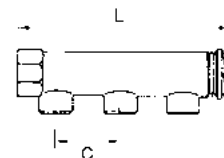

Max. operating pressure	10 bar
-------------------------	--------

Distributor pipe, brass, with 2 outlets

Art. No.	Type No.	Input	Output	Sealant	L mm	C mm
112560	VT 1125	2 x 3/4	2 x 1/2 ET	incl. sealing ring (PTFE) on ET	110.0	50.0
112561	VT 1126	2 x 3/4	2 x 1/2 IT	incl. sealing ring (PTFE) on ET	110.0	50.0
112562	VT 1127	2 x 1	2 x 1/2 ET	incl. sealing ring (PTFE) on ET	113.0	50.0
112563	VT 1128	2 x 1	2 x 1/2 IT	incl. sealing ring (PTFE) on ET	113.0	50.0
112564	VT 1129	2 x 1 1/4	2 x 1/2 AT	without sealing ring	137.0	60.0
112565	VT 1130	2 x 1 1/4	2 x 1/2 IT	without sealing ring	137.0	60.0



Distributor pipe, brass, with 3 outlets

Art. No.	Type No.	Input	Output	Sealant	L mm	C mm
112566	VT 1225	2 x 3/4	3 x 1/2 ET	incl. sealing ring (PTFE) on ET	160.0	50.0
112567	VT 1226	2 x 3/4	3 x 1/2 IT	incl. sealing ring (PTFE) on ET	160.0	50.0
112568	VT 1227	2 x 1	3 x 1/2 ET	incl. sealing ring (PTFE) on ET	163.0	50.0
112569	VT 1228	2 x 1	3 x 1/2 IT	incl. sealing ring (PTFE) on ET	163.0	50.0
112570	VT 1229	2 x 1 1/4	3 x 1/2 ET	without sealing ring	197.0	60.0
112571	VT 1230	2 x 1 1/4	3 x 1/2 IT	without sealing ring	197.0	60.0



Distributor pipe, brass, with 4 outlets

Art. No.	Type No.	Input	Output	Sealant	L mm	C mm
112572	VT 1325	2 x 3/4	4 x 1/2 ET	incl. sealing ring (PTFE) on ET	210.0	50.0
112573	VT 1326	2 x 3/4	4 x 1/2 IT	incl. sealing ring (PTFE) on ET	210.0	50.0
112574	VT 1327	2 x 1	4 x 1/2 ET	incl. sealing ring (PTFE) on ET	213.0	50.0
112575	VT 1328	2 x 1	4 x 1/2 IT	incl. sealing ring (PTFE) on ET	213.0	50.0
112576	VT 1329	2 x 1 1/4	4 x 1/2 ET	without sealing ring	257.0	60.0
112577	VT 1330	2 x 1 1/4	4 x 1/2 IT	without sealing ring	257.0	60.0



Fittings

nickel-plated brass

Max. operating pressure	60 bar
Max. operating temperature	150 °C

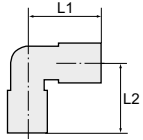

Elbows

nickel-plated brass

PLUS



N 253.01

Elbow, male-male, conical acc. to DIN 2999

Art. No.	Type No.	Thread	L1 mm	L2 mm	a/f mm
112738	N 253.50	M5	11.0	11.0	9
112739	N 253.00	R 1/8	18.5	18.5	10
112740	N 253.01	R 1/4	23.5	23.5	13
112741	N 253.02	R 3/8	26.0	26.0	17
112742	N 253.03	R 1/2	31.0	31.0	21
112743	N 253.04	R 3/4	33.0	33.0	25
112744	N 253.05	R 1	39.0	39.0	30



N 253.12

Elbow, female-female, parallel acc. to DIN EN ISO 228-1

Art. No.	Type No.	Thread	L1 mm	L2 mm	a/f mm
112745	N 253.51	M5	11.0	11.0	9
112746	N 253.11	G 1/8	21.0	21.0	10
112747	N 253.12	G 1/4	25.5	25.5	13
112748	N 253.13	G 3/8	28.0	28.0	17
112749	N 253.14	G 1/2	33.5	33.5	21
112750	N 253.32	G 3/4	36.5	36.5	25
112751	N 253.33	G 1	45.0	45.0	30



N 253.16

Elbow, female/male, female: par. acc. DIN EN ISO 228-1, male: con. acc. DIN 2999

Art. No.	Type No.	Thread	L1 mm	L2 mm	a/f mm
112752	N 253.52	M5	11.5	11.0	9
112753	N 253.15	G/R 1/8	18.5	21.0	10
112754	N 253.16	G/R 1/4	23.5	25.5	13
112755	N 253.17	G/R 3/8	26.0	28.0	17
112756	N 253.18	G/R 1/2	31.0	33.5	21
112757	N 253.19	G/R 3/4	33.0	36.5	25
112758	N 253.20	G/R 1	39.0	45.0	30

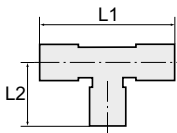

Tees

nickel-plated brass

PLUS



N 254.03

Tee, male-male-male, conical acc. to DIN 2999

Art. No.	Type No.	Thread	L1 mm	L2 mm	a/f mm
112759	N 254.02	R 1/8	37.0	18.5	10
112760	N 254.03	R 1/4	47.0	23.5	13
112761	N 254.04	R 3/8	52.0	26.0	17
112762	N 254.05	R 1/2	62.0	31.0	21
112763	N 254.06	R 3/4	66.4	33.0	25
112764	N 254.07	R 1	78.0	39.0	30

Tees

nickel-plated brass

PLUS

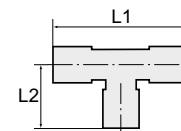

Tee, female-female-female, parallel acc. to DIN EN ISO 228-1

Art. No.	Type No.	Thread	L1 mm	L2 mm	a/f mm
112765	N 254.32	M5	22.0	11.0	9
112766	N 254.33	G 1/8	42.0	21.0	10
112767	N 254.34	G 1/4	51.0	25.5	13
112768	N 254.35	G 3/8	56.0	28.0	17
112769	N 254.39	G 1/2	67.0	33.5	21
112770	N 254.48	G 3/4	73.0	36.5	25
112771	N 254.49	G 1	90.0	45.0	30



N 254.34

Tee, female-male-female, male: con. DIN 2999, female: par. acc. DIN EN ISO 228-1

Art. No.	Type No.	Thread	L1 mm	L2 mm	a/f mm
112772	N 254.40	M5	22.0	11.5	9
112773	N 254.41	G/R 1/8	42.0	18.5	10
112774	N 254.42	G/R 1/4	51.0	23.5	13
112775	N 254.43	G/R 3/8	56.0	26.0	17
112776	N 254.44	G/R 1/2	67.0	31.0	21
112777	N 254.45	G/R 3/4	73.0	33.0	25
112778	N 254.46	G/R 1	90.0	39.0	30



N 254.42

Tee, female-female-male, male: con. DIN 2999, female: par. acc. DIN EN ISO 228-1

Art. No.	Type No.	Thread	L1 mm	L2 mm	a/f mm
112779	N 254.70	M5	22.5	11.0	9
112780	N 254.71	G/R 1/8	39.5	21.0	10
112781	N 254.72	G/R 1/4	49.0	23.5	13
112782	N 254.73	G/R 3/8	54.0	28.0	17
112783	N 254.74	G/R 1/2	64.5	33.5	21
112784	N 254.75	G/R 3/4	69.5	36.5	25
112785	N 254.76	G/R 1	84.0	45.0	30



N 254.72

Tee, male-female-male, male: con. DIN 2999, female: par. acc. DIN EN ISO 228-1

Art. No.	Type No.	Thread	L1 mm	L2 mm	a/f mm
112786	N 254.81	G/R 1/8	37.0	21.0	10
112787	N 254.82	G/R 1/4	47.0	25.5	13
112788	N 254.83	G/R 3/8	52.0	28.0	17
112789	N 254.84	G/R 1/2	62.0	33.5	21
112790	N 254.85	G/R 3/4	66.5	36.5	25
112791	N 254.86	G/R 1	78.0	45.0	30



N 254.82

Tee, male-male-female, male: con. DIN 2999, female: par. acc. DIN EN ISO 228-1

Art. No.	Type No.	Thread	L1 mm	L2 mm	a/f mm
112792	N 254.91	G/R 1/8	39.5	18.5	10
112793	N 254.92	G/R 1/4	49.0	23.5	13
112794	N 254.93	G/R 3/8	54.0	26.0	17
112795	N 254.94	G/R 1/2	64.5	31.0	21
112796	N 254.95	G/R 3/4	69.5	33.0	25
112797	N 254.96	G/R 1	84.0	39.0	30



N 254.92



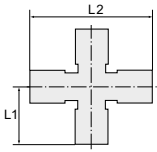

Crosses

nickel-plated brass

PLUS ||



N 255.02

Cross, 4 x female, parallel acc. to DIN EN ISO 228-1

Art. No.	Type No.	Thread	L1 mm	L2 mm	a/f mm
112798	N 255.01	G 1/8	21.0	42.0	10
112799	N 255.02	G 1/4	25.5	51.0	13
112800	N 255.03	G 3/8	28.0	56.0	17
112801	N 255.04	G 1/2	33.5	67.0	21



N 255.12

Cross, 3 x female, 1 x male, male: con. DIN 2999, female: par. DIN EN ISO 228-1

Art. No.	Type No.	Thread	L1 mm	L2 mm	a/f mm
112802	N 255.11	G/R 1/8	18.5	42.0	10
112803	N 255.12	G/R 1/4	23.5	51.0	13
112804	N 255.13	G/R 3/8	26.0	56.0	17
112805	N 255.14	G/R 1/2	31.0	67.0	21

Fittings

brass with a bare metal surface

Max. operating pressure	60 bar
Max. operating temperature	150 °C

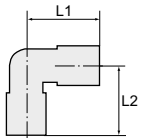

Elbows

brass with a bare metal surface

PLUS ||



253.01

Elbow, male-male, conical acc. to DIN 2999

Art. No.	Type No.	Thread	L1 mm	L2 mm	a/f mm
112696	253.00	R 1/8	18.5	18.5	10
112697	253.01	R 1/4	23.5	23.5	13
112698	253.02	R 3/8	26.0	26.0	17
112699	253.03	R 1/2	31.0	31.0	21
112700	253.04	R 3/4	33.0	33.0	25
112701	253.05	R 1	39.0	39.0	30



253.12

Elbow, female-female, parallel acc. to DIN EN ISO 228-1

Art. No.	Type No.	Thread	L1 mm	L2 mm	a/f mm
112702	253.11	G 1/8	21.0	21.0	10
112703	253.12	G 1/4	25.5	25.5	13
112704	253.13	G 3/8	28.0	28.0	17
112705	253.14	G 1/2	33.5	33.5	21
112706	253.32	G 3/4	36.5	36.5	25
112707	253.33	G 1	45.0	45.0	30

Elbows

brass with a bare metal surface

PLUS

Elbow, female-male, male: con. acc. DIN 2999, female: par. acc. DIN EN ISO 228-1

Art. No.	Type No.	Thread	L1 mm	L2 mm	a/f mm
112708	253.15	G/R 1/8	18.5	21.0	10
112709	253.16	G/R 1/4	23.5	25.5	13
112710	253.17	G/R 3/8	26.0	28.0	17
112711	253.18	G/R 1/2	31.0	33.5	21
112712	253.19	G/R 3/4	33.0	36.5	25
112713	253.20	G/R 1	39.0	45.0	30

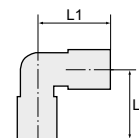

253.17

Tees

brass with a bare metal surface

PLUS

Tee, male-male-male, conical acc. to DIN 2999

Art. No.	Type No.	Thread	L1 mm	L2 mm	a/f mm
112714	254.02	R 1/8	37.0	18.5	10
112715	254.03	R 1/4	47.0	23.5	13
112716	254.04	R 3/8	52.0	26.0	17
112717	254.05	R 1/2	62.0	31.0	21
112718	254.06	R 3/4	66.4	33.0	25
112719	254.07	R 1	78.0	39.0	30

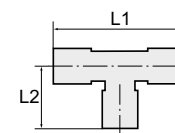

254.03

Tee, female-female-female, parallel acc. to DIN EN ISO 228-1

Art. No.	Type No.	Thread	L1 mm	L2 mm	a/f mm
112720	254.33	G 1/8	42.0	21.0	10
112721	254.34	G 1/4	51.0	25.5	13
112722	254.35	G 3/8	56.0	28.0	17
112723	254.39	G 1/2	67.0	33.5	21
112724	254.48	G 3/4	73.0	36.5	25
112725	254.49	G 1	90.0	45.0	30



254.34

Tee, female-male-female, male: con. DIN 2999, female: par. acc. DIN EN ISO 228-1

Art. No.	Type No.	Thread	L1 mm	L2 mm	a/f mm
112726	254.41	G/R 1/8	42.0	18.5	10
112727	254.42	G/R 1/4	51.0	23.5	13
112728	254.43	G/R 3/8	56.0	26.0	17
112729	254.44	G/R 1/2	67.0	31.0	21
112730	254.45	G/R 3/4	73.0	33.0	25
112731	254.46	G/R 1	90.0	39.0	30



254.42

Tee, female-female-male, male: con. DIN 2999, female: par. acc. DIN EN ISO 228-1

Art. No.	Type No.	Thread	L1 mm	L2 mm	a/f mm
112732	254.71	G/R 1/8	39.5	21.0	10
112733	254.72	G/R 1/4	49.0	25.5	13
112734	254.73	G/R 3/8	54.0	28.0	17
112735	254.74	G/R 1/2	64.5	33.0	21
112736	254.75	G/R 3/4	69.5	36.5	25
112737	254.76	G/R 1	84.0	45.0	30



254.72

Fittings

brass with a bare metal surface

Max. operating pressure	16 bar
Max. operating temperature	120 °C

Elbows

brass with a bare metal surface

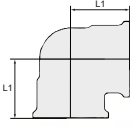

WST34MS90II

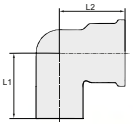

WST34MS90IA

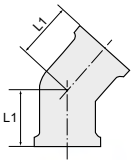

WST34MS45II

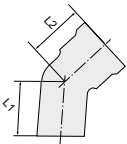

WST34MS45IA

90° elbow, female/female

Art. No.	Type No.	Thread	L1 mm
194100	WST14MS90II	G 1/4	19.0
194101	WST38MS90II	G 3/8	24.0
194102	WST12MS90II	G 1/2	25.0
194103	WST34MS90II	G 3/4	29.0
194104	WST10MS90II	G 1	34.5
194105	WST114MS90II	G 1 1/4	47.0
194106	WST112MS90II	G 1 1/2	50.0
194107	WST20MS90II	G 2	58.5

90° elbow, female/male

Art. No.	Type No.	Thread	L1 mm	L2 mm
194108	WST14MS90IA	G 1/4	27.5	24.5
194109	WST38MS90IA	G 3/8	35.5	22.0
194110	WST12MS90IA	G 1/2	32.0	23.0
194111	WST34MS90IA	G 3/4	41.0	26.0
194112	WST10MS90IA	G 1	49.5	30.0
194113	WST114MS90IA	G 1 1/4	53.5	38.0
194114	WST112MS90IA	G 1 1/2	57.0	41.0
194115	WST20MS90IA	G 2	65.0	54.0

45° elbow, female/female

Art. No.	Type No.	Thread	L1 mm
194116	WST12MS45II	G 1/2	23.5
194117	WST34MS45II	G 3/4	24.0
194118	WST10MS45II	G 1	30.5

45° elbow, female/male

Art. No.	Type No.	Thread	L1 mm	L2 mm
194119	WST12MS45IA	G 1/2	28.0	23.0
194120	WST34MS45IA	G 3/4	28.0	23.0
194121	WST10MS45IA	G 1	34.5	30.5

Tees

brass with a bare metal surface

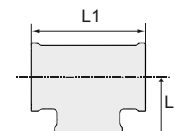

Tee, 3 x female thread					
Art. No.	Type No.	Thread	L1 mm	L2 mm	
194122	TST14MSIG	G 1/4	40.0	20.0	
194123	TST38MSIG	G 3/8	48.0	24.0	
194124	TST12MSIG	G 1/2	53.0	27.0	
194125	TST34MSIG	G 3/4	60.0	30.0	
194126	TST10MSIG	G 1	66.5	33.0	
194127	TST114MSIG	G 1 1/4	90.0	45.0	
194128	TST112MSIG	G 1 1/2	93.0	46.5	
194129	TST20MSIG	G 2	101.0	50.5	



Unequal tee, 3 x female thread					
Art. No.	Type No.	Female thread	Outlet thread	L1 mm	L2 mm
194130	TRED341234MSIG	2 x G 3/4	G 1/2	51.0	28.5
194131	TRED101210MSIG	2 x G 1	G 1/2	66.6	33.0
194132	TRED103410MSIG	2 x G 1	G 3/4	66.6	33.0



TRED103410MSIG

Crosses

brass with a bare metal surface

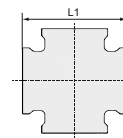

Cross, 4 x female thread				
Art. No.	Type No.	Thread	L1 mm	
194133	KST12MSIG	G 1/2	52.0	
194134	KST34MSIG	G 3/4	61.0	



KST34MSIG



Fittings

stainless steel 1.4408

Max. operating pressure	20 bar
Max. operating temperature	175 °C

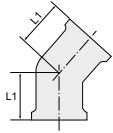

253.13-ES



253.46-ES

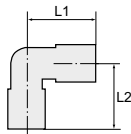

253.18-ES

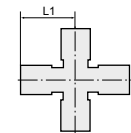

253.66-ES

Elbows

stainless steel 1.4408

90° elbow, female-female, Rp thread acc. to ISO 7-1

Art. No.	Type No.	Thread	L1 mm
112666	253.11-ES	Rp 1/8	16.4
112667	253.12-ES	Rp 1/4	19.2
112668	253.13-ES	Rp 3/8	22.5
112669	253.21-ES	Rp 1/2	27.4
112670	253.22-ES	Rp 3/4	31.1
112671	253.23-ES	Rp 1	36.9

45° elbow, female-female, Rp thread acc. to ISO 7-1

Art. No.	Type No.	Thread	L1 mm
112672	253.41-ES	Rp 1/8	15.6
112673	253.42-ES	Rp 1/4	15.9
112674	253.43-ES	Rp 3/8	17.6
112675	253.44-ES	Rp 1/2	19.2
112676	253.45-ES	Rp 3/4	22.8
112677	253.46-ES	Rp 1	26.7

90° elbow, female-male, female thread: Rp thread acc. to ISO 7-1, male thread: R thread acc. to ISO 7-1

Art. No.	Type No.	Thread	L1 mm	L2 mm
112678	253.15-ES	Rp 1/8 IT, R 1/8 ET	24.0	17.0
112679	253.16-ES	Rp 1/4 IT, R 1/4 ET	28.0	20.0
112680	253.17-ES	Rp 3/8 IT, R 3/8 ET	32.0	22.0
112681	253.18-ES	Rp 1/2 IT, R 1/2 ET	38.0	27.0
112682	253.19-ES	Rp 3/4 IT, R 3/4 ET	45.0	32.0
112683	253.20-ES	Rp 1 IT, R 1 ET	52.0	37.0

X-distributors

stainless steel 1.4408

X-distributor, 4 x female, Rp thread acc. to ISO 7-1

Art. No.	Type No.	Thread	L1 mm
112684	253.61-ES	Rp 1/8	19.0
112685	253.62-ES	Rp 1/4	19.0
112686	253.63-ES	Rp 3/8	23.0
112687	253.64-ES	Rp 1/2	27.0
112688	253.65-ES	Rp 3/4	32.0
112689	253.66-ES	Rp 1	38.0

Tee distributors

stainless steel 1.4408

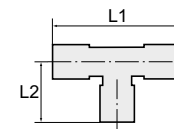

Tee distributor, 3 x female, Rp thread acc. to ISO 7-1					
Art. No.	Type No.	Thread	L1 mm	L2 mm	
112690	254.33-ES	Rp 1/8	34.0	17.0	
112691	254.34-ES	Rp 1/4	38.0	19.0	
112692	254.35-ES	Rp 3/8	46.1	22.0	
112693	254.36-ES	Rp 1/2	54.0	27.0	
112694	254.37-ES	Rp 3/4	63.0	32.0	
112695	254.38-ES	Rp 1	73.0	36.0	



254.36-ES

Fittings

stainless steel 1.4404

Max. operating pressure 150 bar
Operating temperature -20 to 150 °C

Elbows

stainless steel 1.4404

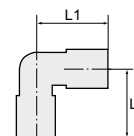

Elbow, male/male, conical acc. to ISO 7-1					
Art. No.	Type No.	Thread	L1 mm	L2 mm	
112806	ES 253.00	R 1/8	17.0	17.0	
112807	ES 253.01	R 1/4	21.0	21.0	
112808	ES 253.02	R 3/8	24.0	24.0	
112809	ES 253.03	R 1/2	30.0	30.0	



ES 253.01

Elbow, female/female, parallel acc. to DIN EN ISO 228-1					
Art. No.	Type No.	Thread	L1 mm	L2 mm	
112810	ES 253.11	G 1/8	22.0	22.0	
112811	ES 253.12	G 1/4	26.0	26.0	
112812	ES 253.13	G 3/8	28.0	28.0	
112813	ES 253.14	G 1/2	34.0	34.0	



ES 253.12

Elbow, female/male, female: parallel DIN EN ISO 228-1, male: conical ISO 7-1					
Art. No.	Type No.	Thread	L1 mm	L2 mm	
112814	ES 253.15	G/R 1/8	22.0	17.0	
112815	ES 253.16	G/R 1/4	26.0	21.5	
112816	ES 253.17	G/R 3/8	28.0	24.5	
112817	ES 253.18	G/R 1/2	34.0	30.5	



ES 253.15



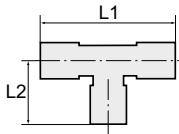

Tees

stainless steel 1.4404



ES 254.34



ES 254.42

Tee, female/female/female, parallel acc. to DIN EN ISO 228-1

Art. No.	Type No.	Thread	L1 mm	L2 mm
112818	ES 254.33	G 1/8	44.0	22.0
112819	ES 254.34	G 1/4	52.0	26.0
112820	ES 254.35	G 3/8	56.0	28.0
112821	ES 254.39	G 1/2	68.0	34.0

Tee, female/male/female, male=conical ISO 7-1, female=parallel DIN EN ISO 228-1

Art. No.	Type No.	Thread	L1 mm	L2 mm
112822	ES 254.41	G/R 1/8	44.0	17.0
112823	ES 254.42	G/R 1/4	52.0	21.5
112824	ES 254.43	G/R 3/8	56.0	24.5
112825	ES 254.44	G/R 1/2	68.0	30.5

Malleable iron fittings

zinc plated - DIN DVGW

Acc. to DIN EN 10242 (formerly DIN 2950)

The classic - and the most popular - screw fitting series for pipe construction.

These fittings are characterized by their high mechanical strength and surface quality to DIN 2444.

They are completely coated with a layer of pure zinc and are therefore suitable for drinking water; they are also protected against rust.

These malleable iron fittings are used in machine construction, exterior lines, cold water lines and heating lines.

Working minimal temperature = -20 °C, 25 bar.

Working pressure for temperature range from -20 °C to 120 °C: 25 bar.

Working pressure for temperature range from 120 °C to 300 °C: 20-25 bar.

Material	Black malleable iron B350-10, design symbol A
Temperature range	-20 to 300 °C
Surface	Hot dip galvanised
Standard thread	acc. ISO 7-1

Bends 90°

zinc plated - DIN DVGW



Long sweep bend 1, 90°, female/male

Art. No.	Type No.	Thread
112826	TFB 1-14	Rp/R 1/4
112827	TFB 1-38	Rp/R 3/8
112828	TFB 1-12	Rp/R 1/2
112829	TFB 1-34	Rp/R 3/4
112830	TFB 1-10	Rp/R 1
112831	TFB 1-114	Rp/R 1 1/4
112832	TFB 1-112	Rp/R 1 1/2
112833	TFB 1-20	Rp/R 2
112834	TFB 1-212	Rp/R 2 1/2
112835	TFB 1-30	Rp/R 3



TFB 1-12

Short bend 1a, 90°, female/male

Art. No.	Type No.	Thread
112836	TFB 1A-14	Rp/R 1/4
112837	TFB 1A-38	Rp/R 3/8
112838	TFB 1A-12	Rp/R 1/2
112839	TFB 1A-34	Rp/R 3/4
112840	TFB 1A-10	Rp/R 1
112841	TFB 1A-114	Rp/R 1 1/4
112842	TFB 1A-112	Rp/R 1 1/2
112843	TFB 1A-20	Rp/R 2
112844	TFB 1A-212	Rp/R 2 1/2



TFB 1A-12

Long sweep bend 2, 90°, female/female

Art. No.	Type No.	Thread
112845	TFB 2-14	Rp 1/4
112846	TFB 2-38	Rp 3/8
112847	TFB 2-12	Rp 1/2
112848	TFB 2-34	Rp 3/4
112849	TFB 2-10	Rp 1
112850	TFB 2-114	Rp 1 1/4
112851	TFB 2-112	Rp 1 1/2
112852	TFB 2-20	Rp 2
112853	TFB 2-212	Rp 2 1/2
112854	TFB 2-30	Rp 3



TFB 2-12



Bends 90°

zinc plated - DIN DVGW



TFB 2A-10

Short bend 2a, 90°, female/female

Art. No.	Type No.	Thread
112855	TFB 2A-14	Rp 1/4
112856	TFB 2A-38	Rp 3/8
112857	TFB 2A-12	Rp 1/2
112858	TFB 2A-34	Rp 3/4
112859	TFB 2A-10	Rp 1
112860	TFB 2A-114	Rp 1 1/4
112861	TFB 2A-112	Rp 1 1/2
112862	TFB 2A-20	Rp 2



TFB 3-34

Long sweep bend 3, 90°, male/male

Art. No.	Type No.	Thread
112863	TFB 3-38	R 3/8
112864	TFB 3-12	R 1/2
112865	TFB 3-34	R 3/4
112866	TFB 3-10	R 1
112867	TFB 3-114	R 1 1/4
112868	TFB 3-112	R 1 1/2
112869	TFB 3-20	R 2

→ Further types and dimensions on request.

Bends 45°

zinc plated - DIN DVGW



TFB 40-10

Bend 40, 45°, female/male

Art. No.	Type No.	Thread
112870	TFB 40-14	Rp/R 1/4
112871	TFB 40-38	Rp/R 3/8
112872	TFB 40-12	Rp/R 1/2
112873	TFB 40-34	Rp/R 3/4
112874	TFB 40-10	Rp/R 1
112875	TFB 40-114	Rp/R 1 1/4
112876	TFB 40-112	Rp/R 1 1/2
112877	TFB 40-20	Rp/R 2
112878	TFB 40-212	Rp/R 2 1/2
112879	TFB 40-30	Rp/R 3



TFB 41-10

Bend 41, 45°, female/female

Art. No.	Type No.	Thread
112880	TFB 41-38	Rp 3/8
112881	TFB 41-12	Rp 1/2
112882	TFB 41-34	Rp 3/4
112883	TFB 41-10	Rp 1
112884	TFB 41-114	Rp 1 1/4
112885	TFB 41-112	Rp 1 1/2
112886	TFB 41-20	Rp 2
112887	TFB 41-212	Rp 2 1/2
112888	TFB 41-30	Rp 3

→ Further types and dimensions on request.

Elbows 90°

zinc plated - DIN DVGW



Elbow 90, 90°, female/female

Art. No.	Type No.	Thread
112889	TFW 90-14	Rp 1/4
112890	TFW 90-38	Rp 3/8
112891	TFW 90-12	Rp 1/2
112892	TFW 90-34	Rp 3/4
112893	TFW 90-10	Rp 1
112894	TFW 90-114	Rp 1 1/4
112895	TFW 90-112	Rp 1 1/2
112896	TFW 90-20	Rp 2
112897	TFW 90-212	Rp 2 1/2
112898	TFW 90-30	Rp 3



TFW 90-12

Elbow 90, 90°, reduced, female/female

Art. No.	Type No.	Thread 1	Thread 2
133560	TFW 90-1238	Rp 1/2	Rp 3/8
133561	TFW 90-3412	Rp 3/4	Rp 1/2
133562	TFW 90-1012	Rp 1	Rp 1/2
133563	TFW 90-1034	Rp 1	Rp 3/4
133564	TFW 90-11410	Rp 1 1/4	Rp 1
133565	TFW 90-11212	Rp 1 1/2	Rp 1/2
133566	TFW 90-112114	Rp 1 1/2	Rp 1 1/4
133567	TFW 90-21	Rp 2	Rp 1
133568	TFW 90-212112	Rp 2 1/2	Rp 1 1/2



TFW 90-1012

Elbow 92, 90°, female/male

Art. No.	Type No.	Thread
112899	TFW 92-14	Rp/R 1/4
112900	TFW 92-38	Rp/R 3/8
112901	TFW 92-12	Rp/R 1/2
112902	TFW 92-34	Rp/R 3/4
112903	TFW 92-10	Rp/R 1
112904	TFW 92-114	Rp/R 1 1/4
112905	TFW 92-112	Rp/R 1 1/2
112906	TFW 92-20	Rp/R 2
112907	TFW 92-212	Rp/R 2 1/2
112908	TFW 92-30	Rp/R 3



TFW 92-12

Elbow 94, 90°, male/male

Art. No.	Type No.	Thread
112909	TFW 94-38	R 3/8
112910	TFW 94-12	R 1/2
112911	TFW 94-34	R 3/4
112912	TFW 94-10	R 1
112913	TFW 94-114	R 1 1/4
112914	TFW 94-112	R 1 1/2
112915	TFW 94-20	R 2



TFW 94-38

→ Further types and dimensions on request.



Union elbows, flat seat

zinc plated - DIN DVGW



Maximum temperature and maximum operating pressure should not occur at the same time!

Acc. to DIN EN 10242 (formerly DIN 2950)

The classic - and the most popular - screw fitting series for pipe construction. These fittings are characterized by their high mechanical strength and surface quality to DIN 2444. They are completely coated with a layer of pure zinc and are therefore suitable for drinking water; they are also protected against rust. These malleable iron fittings are used in machine construction, exterior lines, cold water lines and heating lines.

Temperature range -20 to 200 °C



TFV 95-10



TFV 97-10

Union elbow 95, flat seat, female/female, without seal

Art. No.	Type No.	Thread
112916	TFV 95-12	Rp 1/2
112917	TFV 95-34	Rp 3/4
112918	TFV 95-10	Rp 1
112919	TFV 95-114	Rp 1 1/4
112920	TFV 95-112	Rp 1 1/2
112921	TFV 95-20	Rp 2

Union elbow 97, flat seat, female/male, without seal

Art. No.	Type No.	Thread 1	Thread 2
112929	TFV 97-12	Rp 1/2	R 1/2
112930	TFV 97-34	Rp 3/4	R 3/4
112931	TFV 97-10	Rp 1	R 1
112932	TFV 97-114	Rp 1 1/4	R 1 1/4
112933	TFV 97-112	Rp 1 1/2	R 1 1/2
112934	TFV 97-20	Rp 2	R 2

- ➔ Further types and dimensions on request.
- ➔ For flat seat for union elbow 95 and union elbow 97 please look at page 797
- ➔ Maximum temperature and maximum operating pressure should not occur at the same time!

Union elbows, taper seat

zinc plated - DIN DVGW



TFV 96-10



TFV 98-10

Union elbow 96, taper seat, female/female

Art. No.	Type No.	Thread
112922	TFV 96-12	Rp 1/2
112923	TFV 96-34	Rp 3/4
112924	TFV 96-10	Rp 1
112925	TFV 96-114	Rp 1 1/4
112926	TFV 96-112	Rp 1 1/2
112927	TFV 96-20	Rp 2
112928	TFV 96-212	Rp 2 1/2

Union elbow 98, taper seat, female/male

Art. No.	Type No.	Thread 1	Thread 2
112935	TFV 98-14	Rp 1/4	R 1/4
112936	TFV 98-12	Rp 1/2	R 1/2
112937	TFV 98-34	Rp 3/4	R 3/4

Union elbows, taper seat

zinc plated - DIN DVGW



Union elbow 98, taper seat, female/male

Art. No.	Type No.	Thread 1	Thread 2
112938	TFV 98-10	Rp 1	R 1
112939	TFV 98-114	Rp 1 1/4	R 1 1/4
112940	TFV 98-112	Rp 1 1/2	R 1 1/2
112941	TFV 98-20	Rp 2	R 2
112942	TFV 98-212	Rp 2 1/2	R 2 1/2



TFV 98-10

→ Further types and dimensions on request.

Elbows 45°

zinc plated - DIN DVGW



Elbow 120, 45°, female/female

Art. No.	Type No.	Thread
112943	TFW 120-38	Rp 3/8
112944	TFW 120-12	Rp 1/2
112945	TFW 120-34	Rp 3/4
112946	TFW 120-10	Rp 1
112947	TFW 120-114	Rp 1 1/4
112948	TFW 120-112	Rp 1 1/2
112949	TFW 120-20	Rp 2
112950	TFW 120-212	Rp 2 1/2
112951	TFW 120-30	Rp 3



TFW 120-12

Elbow 121, 45°, female/male

Art. No.	Type No.	Thread
112952	TFW 121-38	Rp/R 3/8
112953	TFW 121-12	Rp/R 1/2
112954	TFW 121-34	Rp/R 3/4
112955	TFW 121-10	Rp/R 1
112956	TFW 121-114	Rp/R 1 1/4
112957	TFW 121-112	Rp/R 1 1/2
112958	TFW 121-20	Rp/R 2



TFW 121-12

→ Further types and dimensions on request.

Tees

zinc plated - DIN DVGW



Tee 130, female/female/female

Art. No.	Type No.	Thread
112959	TFT 130-14	Rp 1/4
112960	TFT 130-38	Rp 3/8
112961	TFT 130-12	Rp 1/2
112962	TFT 130-34	Rp 3/4
112963	TFT 130-10	Rp 1
112964	TFT 130-114	Rp 1 1/4



TFT 130-12



Tees

zinc plated - DIN DVGW



TFT 130-12



TFT 130-3438



TFT 133-38



TFT 134-10

Tee 130, female/female/female

Art. No.	Type No.	Thread
112965	TFT 130-112	Rp 1 1/2
112966	TFT 130-20	Rp 2
112967	TFT 130-212	Rp 2 1/2
112968	TFT 130-30	Rp 3

Tee 130, reducing, female/female/female

Art. No.	Type No.	Thread 1	Thread 2 Reduced branch tee	Thread 3
112969	TFT 130-3814	Rp 3/8	Rp 1/4	Rp 3/8
112970	TFT 130-1214	Rp 1/2	Rp 1/4	Rp 1/2
112971	TFT 130-1238	Rp 1/2	Rp 3/8	Rp 1/2
125298	TFT 130-3414	Rp 3/4	Rp 1/4	Rp 3/4
112973	TFT 130-3438	Rp 3/4	Rp 3/8	Rp 3/4
112974	TFT 130-3412	Rp 3/4	Rp 1/2	Rp 3/4
112975	TFT 130-1038	Rp 1	Rp 3/8	Rp 1
112976	TFT 130-1012	Rp 1	Rp 1/2	Rp 1
112977	TFT 130-1034	Rp 1	Rp 3/4	Rp 1
125297	TFT 130-11438	Rp 1 1/4	Rp 3/8	Rp 1 1/4
112979	TFT 130-11412	Rp 1 1/4	Rp 1/2	Rp 1 1/4
112980	TFT 130-11434	Rp 1 1/4	Rp 3/4	Rp 1 1/4
112981	TFT 130-11410	Rp 1 1/4	Rp 1	Rp 1 1/4
125296	TFT 130-11238	Rp 1 1/2	Rp 3/8	Rp 1 1/2
112983	TFT 130-11212	Rp 1 1/2	Rp 1/2	Rp 1 1/2
112984	TFT 130-11234	Rp 1 1/2	Rp 3/4	Rp 1 1/2
112985	TFT 130-11210	Rp 1 1/2	Rp 1	Rp 1 1/2
112986	TFT130-112114	Rp 1 1/2	Rp 1 1/4	Rp 1 1/2
112987	TFT 130-2012	Rp 2	Rp 1/2	Rp 2
112988	TFT 130-2034	Rp 2	Rp 3/4	Rp 2
112989	TFT 130-2010	Rp 2	Rp 1	Rp 2
112990	TFT 130-20114	Rp 2	Rp 1 1/4	Rp 2
112991	TFT 130-20112	Rp 2	Rp 1 1/2	Rp 2
112992	TFT 130-21210	Rp 2 1/2	Rp 1	Rp 2 1/2
112993	TFT130-212114	Rp 2 1/2	Rp 1 1/4	Rp 2 1/2
112994	TFT130-212112	Rp 2 1/2	Rp 1 1/2	Rp 2 1/2
112995	TFT 130-21220	Rp 2 1/2	Rp 2	Rp 2 1/2
112996	TFT 130-3020	Rp 3	Rp 2	Rp 3
112997	TFT 130-30212	Rp 3	Rp 2 1/2	Rp 3

Tee 133, female/male/female

Art. No.	Type No.	Thread
112998	TFT 133-38	Rp 3/8
112999	TFT 133-12	Rp 1/2
113000	TFT 133-10	Rp 1

Tee 134, female/female/male

Art. No.	Type No.	Thread 1	Thread 2	Thread 3
113001	TFT 134-12	Rp 1/2	R 1/2	Rp 1/2
113002	TFT 134-34	Rp 3/4	R 3/4	Rp 3/4
113003	TFT 134-10	Rp 1	R 1	Rp 1
113004	TFT 134-114	Rp 1 1/4	R 1 1/4	Rp 1 1/4
113005	TFT 134-112	Rp 1 1/2	R 1 1/2	Rp 1 1/2
113006	TFT 134-20	Rp 2	R 2	Rp 2

➔ Further types and dimensions on request.

Crosses

zinc plated - DIN DVGW



Cross 180, 4 x female

Art. No.	Type No.	Thread
113007	TFK 180-14	Rp 1/4
113008	TFK 180-38	Rp 3/8
113009	TFK 180-12	Rp 1/2
113010	TFK 180-34	Rp 3/4
113011	TFK 180-10	Rp 1
113012	TFK 180-114	Rp 1 1/4
113013	TFK 180-112	Rp 1 1/2
113014	TFK 180-20	Rp 2
113015	TFK 180-30	Rp 3



TFK 180-12

→ Further types and dimensions on request.

Y-pieces

zinc plated - DIN DVGW



Y-piece 220, female/female/female

Art. No.	Type No.	Thread
113016	TFY 220-12	Rp 1/2
113017	TFY 220-34	Rp 3/4
113018	TFY 220-10	Rp 1



TFY 220-10

→ Further types and dimensions on request.

Elbow connectors

zinc plated - DIN DVGW



Elbow connector 221, female/female/female

Art. No.	Type No.	Thread
113019	TFE 221-12	Rp 1/2
113020	TFE 221-34	Rp 3/4
113021	TFE 221-10	Rp 1
113022	TFE 221-112	Rp 1 1/2
113023	TFE 221-20	Rp 2



TFE 221-10

→ Further types and dimensions on request.



Sockets

zinc plated - DIN DVGW



TFM 240-1012

Socket 240, reducing, female/female

Art. No.	Type No.	Thread 1	Thread 2
113024	TFM 240-3814	Rp 3/8	Rp 1/4
113025	TFM 240-1214	Rp 1/2	Rp 1/4
113026	TFM 240-1238	Rp 1/2	Rp 3/8
113027	TFM 240-3414	Rp 3/4	Rp 1/4
113028	TFM 240-3438	Rp 3/4	Rp 3/8
113029	TFM 240-3412	Rp 3/4	Rp 1/2
113030	TFM 240-1038	Rp 1	Rp 3/8
113031	TFM 240-1012	Rp 1	Rp 1/2
113032	TFM 240-1034	Rp 1	Rp 3/4
125295	TFM 240-11438	Rp 1 1/4	Rp 3/8
113034	TFM 240-11412	Rp 1 1/4	Rp 1/2
113035	TFM 240-11434	Rp 1 1/4	Rp 3/4
113036	TFM 240-11410	Rp 1 1/4	Rp 1
113037	TFM 240-11212	Rp 1 1/2	Rp 1/2
113038	TFM 240-11234	Rp 1 1/2	Rp 3/4
113039	TFM 240-11210	Rp 1 1/2	Rp 1
113040	TFM240-112114	Rp 1 1/2	Rp 1 1/4
113041	TFM 240-2012	Rp 2	Rp 1/2
113042	TFM 240-2034	Rp 2	Rp 3/4
113043	TFM 240-2010	Rp 2	Rp 1
113044	TFM 240-20114	Rp 2	Rp 1 1/4
113045	TFM 240-20112	Rp 2	Rp 1 1/2
113046	TFM 240-21220	Rp 2 1/2	Rp 2
113047	TFM 240-30112	Rp 3	Rp 1 1/2
113048	TFM 240-3020	Rp 3	Rp 2
113049	TFM 240-30212	Rp 3	Rp 2 1/2



TFM 270-12

Socket 270, female/female

Art. No.	Type No.	Thread
113050	TFM 270-14	Rp 1/4
113051	TFM 270-38	Rp 3/8
113052	TFM 270-12	Rp 1/2
113053	TFM 270-34	Rp 3/4
113054	TFM 270-10	Rp 1
113055	TFM 270-114	Rp 1 1/4
113056	TFM 270-112	Rp 1 1/2
113057	TFM 270-20	Rp 2
113058	TFM 270-212	Rp 2 1/2
113059	TFM 270-30	Rp 3

→ Further types and dimensions on request.

Reducing bushes

zinc plated - DIN DVGW



TFR 241-1214

Reducing bush 241, male/female

Art. No.	Type No.	Thread 1	Thread 2
113060	TFR 241-3814	R 3/8	Rp 1/4
113061	TFR 241-1214	R 1/2	Rp 1/4
113062	TFR 241-1238	R 1/2	Rp 3/8
113063	TFR 241-3414	R 3/4	Rp 1/4
113064	TFR 241-3438	R 3/4	Rp 3/8
113065	TFR 241-3412	R 3/4	Rp 1/2

Reducing bushes

zinc plated - DIN DVGW



Reducing bush 241, male/female

Art. No.	Type No.	Thread 1	Thread 2
113066	TFR 241-1038	R 1	Rp 3/8
113067	TFR 241-1012	R 1	Rp 1/2
113068	TFR 241-1034	R 1	Rp 3/4
113069	TFR 241-11438	R 1 1/4	Rp 3/8
113070	TFR 241-11412	R 1 1/4	Rp 1/2
113071	TFR 241-11434	R 1 1/4	Rp 3/4
113072	TFR 241-11410	R 1 1/4	Rp 1
113073	TFR 241-11238	R 1 1/2	Rp 3/8
113074	TFR 241-11212	R 1 1/2	Rp 1/2
113075	TFR 241-11234	R 1 1/2	Rp 3/4
113076	TFR 241-11210	R 1 1/2	Rp 1
113077	TFR241-112114	R 1 1/2	Rp 1 1/4
113078	TFR 241-2012	R 2	Rp 1/2
113079	TFR 241-2034	R 2	Rp 3/4
113080	TFR 241-2010	R 2	Rp 1
113081	TFR 241-20114	R 2	Rp 1 1/4
113082	TFR 241-20112	R 2	Rp 1 1/2
113083	TFR241-212112	R 2 1/2	Rp 1 1/2
113084	TFR 241-21220	R 2 1/2	Rp 2
113085	TFR 241-30112	R 3	Rp 1 1/2
113086	TFR 241-3020	R 3	Rp 2
113087	TFR 241-30212	R 3	Rp 2 1/2



TFR 241-1214

→ Further types and dimensions on request.

Hexagon nipples

zinc plated - DIN DVGW



Hexagon nipple 245, reducing, male/male

Art. No.	Type No.	Thread 1	Thread 2
113088	TFD 245-3814	R 3/8	R 1/4
113089	TFD 245-1214	R 1/2	R 1/4
113090	TFD 245-1238	R 1/2	R 3/8
113091	TFD 245-3438	R 3/4	R 3/8
113092	TFD 245-3412	R 3/4	R 1/2
113093	TFD 245-1012	R 1	R 1/2
113094	TFD 245-1034	R 1	R 3/4
113095	TFD 245-11434	R 1 1/4	R 3/4
113096	TFD 245-11410	R 1 1/4	R 1
133569	TFD 245-11212	R 1 1/2	R 1/2
133570	TFD 245-11234	R 1 1/2	R 3/4
113097	TFD 245-11210	R 1 1/2	R 1
113098	TFD245-112114	R 1 1/2	R 1 1/4
133571	TFD 245-234	R 2	R 3/4
113099	TFD 245-20114	R 2	R 1 1/4
113100	TFD 245-20112	R 2	R 1 1/2
113101	TFD245-212112	R 2 1/2	R 1 1/2
113102	TFD 245-21220	R 2 1/2	R 2
113103	TFD 245-3020	R 3	R 2
113104	TFD 245-30212	R 3	R 2 1/2



TFD 245-1238



Hexagon nipples

zinc plated - DIN DVGW



TFD 280-12

Hexagon nipple 280, male/male

Art. No.	Type No.	Thread
113105	TFD 280-14	R 1/4
113106	TFD 280-38	R 3/8
113107	TFD 280-12	R 1/2
113108	TFD 280-34	R 3/4
113109	TFD 280-10	R 1
113110	TFD 280-114	R 1 1/4
113111	TFD 280-112	R 1 1/2
113112	TFD 280-20	R 2
113113	TFD 280-212	R 2 1/2
113114	TFD 280-30	R 3

→ Further types and dimensions on request.

Sockets, reducing

zinc plated - DIN DVGW



TFM 246-1012

Socket 246, reducing, female/male

Art. No.	Type No.	Thread 1	Thread 2
113115	TFM 246-3814	Rp 3/8	R 1/4
113116	TFM 246-1214	Rp 1/2	R 1/4
113117	TFM 246-1238	Rp 1/2	R 3/8
113118	TFM 246-3412	Rp 3/4	R 1/2
113119	TFM 246-1012	Rp 1	R 1/2
113120	TFM 246-1034	Rp 1	R 3/4
113121	TFM 246-11434	Rp 1 1/4	R 3/4
113122	TFM 246-11410	Rp 1 1/4	R 1
113123	TFM 246-11210	Rp 1 1/2	R 1
113124	TFM246-112114	Rp 1 1/2	R 1 1/4
113125	TFM 246-2010	Rp 2	R 1
113126	TFM 246-20114	Rp 2	R 1 1/4
113127	TFM 246-20112	Rp 2	R 1 1/2
113128	TFM 246-21220	Rp 2 1/2	R 2
113129	TFM 246-3020	Rp 3	R 2
113130	TFM 246-30212	Rp 3	R 2 1/2

→ Further types and dimensions on request.

Plugs

zinc plated - DIN DVGW



Plugs 290, male

Art. No.	Type No.	Thread
113131	TFS 290-14	R 1/4
113132	TFS 290-38	R 3/8
113133	TFS 290-12	R 1/2
113134	TFS 290-34	R 3/4
113135	TFS 290-10	R 1
113136	TFS 290-114	R 1 1/4
113137	TFS 290-112	R 1 1/2
113138	TFS 290-20	R 2
113139	TFS 290-212	R 2 1/2
113140	TFS 290-30	R 3



TFS 290-10

→ Further types and dimensions on request.

Caps

zinc plated - DIN DVGW



Cap 300, female

Art. No.	Type No.	Thread
113141	TFK 300-14	Rp 1/4
113142	TFK 300-38	Rp 3/8
113143	TFK 300-12	Rp 1/2
113144	TFK 300-34	Rp 3/4
113145	TFK 300-10	Rp 1
113146	TFK 300-114	Rp 1 1/4
113147	TFK 300-112	Rp 1 1/2
113148	TFK 300-20	Rp 2
113149	TFK 300-212	Rp 2 1/2
113150	TFK 300-30	Rp 3



TFK 300-12

→ Further types and dimensions on request.

Lock nuts

zinc plated - DIN DVGW



Lock nut 310, female

Art. No.	Type No.	Thread
113151	TFG 310-14	Rp 1/4
113152	TFG 310-38	Rp 3/8
113153	TFG 310-12	Rp 1/2
113154	TFG 310-34	Rp 3/4
113155	TFG 310-10	Rp 1
113156	TFG 310-112	Rp 1 1/2
113157	TFG 310-20	Rp 2
113158	TFG 310-212	Rp 2 1/2
113159	TFG 310-30	Rp 3



TFG 310-10

→ Further types and dimensions on request.



Unions, flat seat

zinc plated - DIN DVGW



Maximum temperature and maximum operating pressure should not occur at the same time!

Acc. to DIN EN 10242 (formerly DIN 2950)

The classic - and the most popular - screw fitting series for pipe construction. These fittings are characterized by their high mechanical strength and surface quality to DIN 2444. They are completely coated with a layer of pure zinc and are therefore suitable for drinking water; they are also protected against rust. These malleable iron fittings are used in machine construction, exterior lines, cold water lines and heating lines.

Temperature range -20 to 200 °C



TFV 330-12-D

Union 330, flat seat, female/female, with NBR-seal (NBR with aramide fiber)

Art. No.	Type No.	Thread
113160	TFV 330-14-D	Rp/Rp 1/4
113161	TFV 330-38-D	Rp/Rp 3/8
113162	TFV 330-12-D	Rp/Rp 1/2
113163	TFV 330-34-D	Rp/Rp 3/4
113164	TFV 330-10-D	Rp/Rp 1
113165	TFV 330-114-D	Rp/Rp 1 1/4
113166	TFV 330-112-D	Rp/Rp 1 1/2
113167	TFV 330-20-D	Rp/Rp 2
113168	TFV 330-212-D	Rp/Rp 2 1/2
113169	TFV 330-30-D	Rp/Rp 3



TFV 331-12-D

Union 331, flat seat, female/male, with NBR-seal (NBR with aramide fiber)

Art. No.	Type No.	Thread
113170	TFV 331-14-D	Rp/R 1/4
113171	TFV 331-38-D	Rp/R 3/8
113172	TFV 331-12-D	Rp/R 1/2
113173	TFV 331-34-D	Rp/R 3/4
113174	TFV 331-10-D	Rp/R 1
113175	TFV 331-114-D	Rp/R 1 1/4
113176	TFV 331-112-D	Rp/R 1 1/2
113177	TFV 331-20-D	Rp/R 2
113178	TFV 331-212-D	Rp/R 2 1/2

→ Further types and dimensions on request.

→ Maximum temperature and maximum operating pressure should not occur at the same time!

Unions, taper seat

zinc plated - DIN DVGW



Union 340, taper seat, female/female

Art. No.	Type No.	Thread
113179	TFV 340-14	Rp/Rp 1/4
113180	TFV 340-38	Rp/Rp 3/8
113181	TFV 340-12	Rp/Rp 1/2
113182	TFV 340-34	Rp/Rp 3/4
113183	TFV 340-10	Rp/Rp 1
113184	TFV 340-114	Rp/Rp 1 1/4
113185	TFV 340-112	Rp/Rp 1 1/2
113186	TFV 340-20	Rp/Rp 2
113187	TFV 340-212	Rp/Rp 2 1/2
113188	TFV 340-30	Rp/Rp 3



TFV 340-12

Union 341, taper seat, female/male

Art. No.	Type No.	Thread
113189	TFV 341-14	Rp/R 1/4
113190	TFV 341-38	Rp/R 3/8
113191	TFV 341-12	Rp/R 1/2
113192	TFV 341-34	Rp/R 3/4
113193	TFV 341-10	Rp/R 1
113194	TFV 341-114	Rp/R 1 1/4
113195	TFV 341-112	Rp/R 1 1/2
113196	TFV 341-20	Rp/R 2
113197	TFV 341-212	Rp/R 2 1/2
113198	TFV 341-30	Rp/R 3



TFV 341-10

→ Further types and dimensions on request.

Flat seals

suitable for malleable iron fittings flat sealing

Maximum temperature and maximum operating pressure should not occur at the same time!

Temperature range -20 to 200 °C

Flat seal for malleable iron fittings (NBR with aramide fiber)

Art. No.	Type No.	Connection	D mm	D1 mm	H mm
162262	TFD 14-1	1/4	17.0	24.0	2.0
113200	TFD 38	3/8	19.0	27.0	2.0
113201	TFD 12	1/2	21.0	30.0	2.0
113202	TFD 34	3/4	27.0	38.0	2.0
113203	TFD 10	1	32.0	44.0	2.0
113204	TFD 114	1 1/4	42.0	55.0	2.0
113205	TFD 112	1 1/2	46.0	62.0	2.0
113206	TFD 20	2	60.0	78.0	2.0
113207	TFD 212	2 1/2	75.0	97.0	2.0
113208	TFD 30	3	88.0	110.0	2.0

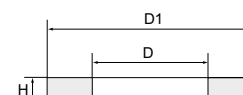

→ Maximum temperature and maximum operating pressure should not occur at the same time!

Double pipe nipples

zinc plated



Max. working pressure	50 bar
Standard thread	acc. ISO 7-1
Material	Zinc plated steel ST 37-2
Surface	Hot dip galvanised



SFR 23-1280

Double pipe nipple 23, male/male, zinc plated steel ST 37-2

Art. No.	Type No.	Thread	Length mm
113209	SFR 23-1440	R 1/4	40.0
113210	SFR 23-1460	R 1/4	60.0
113211	SFR 23-1480	R 1/4	80.0
113212	SFR 23-14100	R 1/4	100.0
113213	SFR 23-14120	R 1/4	120.0
113214	SFR 23-14150	R 1/4	150.0
113215	SFR 23-14180	R 1/4	180.0
113216	SFR 23-14200	R 1/4	200.0
113217	SFR 23-3840	R 3/8	40.0
113218	SFR 23-3860	R 3/8	60.0
113219	SFR 23-3880	R 3/8	80.0
113220	SFR 23-38100	R 3/8	100.0
113221	SFR 23-38120	R 3/8	120.0
113222	SFR 23-38150	R 3/8	150.0
113223	SFR 23-38180	R 3/8	180.0
113224	SFR 23-38200	R 3/8	200.0
113225	SFR 23-1240	R 1/2	40.0
113226	SFR 23-1260	R 1/2	60.0
113227	SFR 23-1280	R 1/2	80.0
113228	SFR 23-12100	R 1/2	100.0
113229	SFR 23-12120	R 1/2	120.0
113230	SFR 23-12150	R 1/2	150.0
113231	SFR 23-12180	R 1/2	180.0
113232	SFR 23-12200	R 1/2	200.0
113233	SFR 23-3440	R 3/4	40.0
113234	SFR 23-3460	R 3/4	60.0
113235	SFR 23-3480	R 3/4	80.0
113236	SFR 23-34100	R 3/4	100.0
113237	SFR 23-34120	R 3/4	120.0
113238	SFR 23-34150	R 3/4	150.0
113239	SFR 23-34180	R 3/4	180.0
113240	SFR 23-34200	R 3/4	200.0
113241	SFR 23-1040	R 1	40.0
113242	SFR 23-1060	R 1	60.0
113243	SFR 23-1080	R 1	80.0
113244	SFR 23-10100	R 1	100.0
113245	SFR 23-10120	R 1	120.0
113246	SFR 23-10150	R 1	150.0
113247	SFR 23-10180	R 1	180.0
113248	SFR 23-10200	R 1	200.0
113249	SFR 23-11440	R 1 1/4	40.0
113250	SFR 23-11460	R 1 1/4	60.0
113251	SFR 23-11480	R 1 1/4	80.0
113252	SFR 23-114100	R 1 1/4	100.0
113253	SFR 23-114120	R 1 1/4	120.0
113254	SFR 23-114150	R 1 1/4	150.0
113255	SFR 23-114180	R 1 1/4	180.0
113256	SFR 23-114200	R 1 1/4	200.0

Double pipe nipples

zinc plated



SFR 23-1280

Double pipe nipple 23, male/male, zinc plated steel ST 37-2				
Art. No.	Type No.	Thread		Length mm
113257	SFR 23-11240	R 1 1/2		40.0
113258	SFR 23-11260	R 1 1/2		60.0
113259	SFR 23-11280	R 1 1/2		80.0
113260	SFR 23-112100	R 1 1/2		100.0
113261	SFR 23-112120	R 1 1/2		120.0
113262	SFR 23-112150	R 1 1/2		150.0
113263	SFR 23-112180	R 1 1/2		180.0
113264	SFR 23-112200	R 1 1/2		200.0
113265	SFR 23-2040	R 2		40.0
113266	SFR 23-2060	R 2		60.0
113267	SFR 23-2080	R 2		80.0
113268	SFR 23-20100	R 2		100.0
113269	SFR 23-20120	R 2		120.0
113270	SFR 23-20150	R 2		150.0
113271	SFR 23-20180	R 2		180.0
113272	SFR 23-20200	R 2		200.0
113273	SFR 23-21280	R 2 1/2		80.0
113274	SFR 23-212100	R 2 1/2		100.0
113275	SFR 23-212120	R 2 1/2		120.0
113276	SFR 23-212150	R 2 1/2		150.0
113277	SFR 23-212180	R 2 1/2		180.0
113278	SFR 23-212200	R 2 1/2		200.0
113279	SFR 23-3080	R 3		80.0
113280	SFR 23-30100	R 3		100.0
113281	SFR 23-30120	R 3		120.0
113282	SFR 23-30150	R 3		150.0
113283	SFR 23-30180	R 3		180.0
113284	SFR 23-30200	R 3		200.0



Weld-on sleeve

With a bare metal surface



Max. working pressure	50 bar
Standard thread	acc. ISO 7-1
Material	Steel with a bare metal surface ST 37-2
Surface	Steel with a bare metal surface



SFM 16-1234

Weld-on sleeve 16 made of steel with a bare metal surface ST 37-2, with continuous thread

Art. No.	Type No.	Thread	Length mm
113285	SFM 16-1425	Rp 1/4	25.0
113286	SFM 16-3826	Rp 3/8	26.0
113287	SFM 16-1234	Rp 1/2	34.0
113288	SFM 16-3436	Rp 3/4	36.0
113289	SFM 16-1043	Rp 1	43.0
113290	SFM 16-11448	Rp 1 1/4	48.0
113291	SFM 16-11248	Rp 1 1/2	48.0
113292	SFM 16-2056	Rp 2	56.0
113293	SFM 16-21265	Rp 2 1/2	65.0
113294	SFM 16-3071	Rp 3	71.0

Plastic silencers

with polyethylene damper element

EASY

Max. operating pressure 6 bar
 Operating temperature 5 to 80 °C

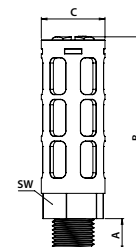

SD14PE

Plastic silencer, with polyethylene damper element

Art. No.	Type No.	Thread	A mm	B mm	C mm
156497	SD5PE	M5	4.5	19.0	8.0
156498	SD18PE	G 1/8	7.0	40.3	16.0
156499	SD14PE	G 1/4	10.8	65.0	21.0
156500	SD38PE	G 3/8	13.0	83.5	25.0
156501	SD12PE	G 1/2	14.0	94.3	30.0
156502	SD34PE	G 3/4	16.0	115.0	45.5
156503	SD1PE	G 1	18.0	117.6	45.5

Plastic silencers

with granular filling

EASY

With granular filling, self-cleaning.
 The spherical shape of the granules allows very fine dust to escape in addition to air.
 Higher blow-off rate.

Max. operating pressure 12 bar
 Operating temperature -20 to 70 °C

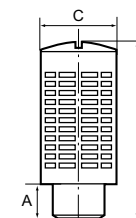

577-3

Plastic silencer, with granular filling

Art. No.	Type No.	Thread	A mm	B mm	C mm
113376	577-1	G 1/8	6.0	33.0	15.0
113377	577-2	G 1/4	8.0	43.0	19.0
113378	577-3	G 3/8	11.0	57.0	24.5
113379	577-4	G 1/2	11.0	57.0	24.5
113380	577-5	G 3/4	17.5	112.0	48.0
113381	577-6	G 1	16.0	110.5	48.0

Plastic silencers

with steel mesh and cotton cloth filling

EASY

Impurities are retained due to the steel mesh and cotton cloth filling; only air escapes. Improved silencing effect.

Max. operating pressure 12 bar
 Operating temperature -20 to 70 °C

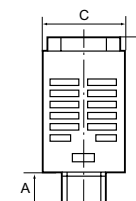

578-4

Plastic silencer, with steel mesh and cotton cloth filling

Art. No.	Type No.	Thread	A mm	B mm	C mm
113382	578-1	G 1/8	6.0	34.0	15.5
113383	578-2	G 1/4	8.0	43.0	19.5
113384	578-3	G 3/8	10.5	58.0	24.5

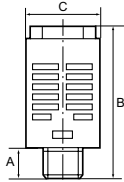

578-4

Plastic silencers

with steel mesh and cotton cloth filling

EASY

Plastic silencer, with steel mesh and cotton cloth filling

Art. No.	Type No.	Thread	A mm	B mm	C mm
113385	578-4	G 1/2	10.5	58.0	24.5
113386	578-5	G 3/4	17.5	112.0	48.0
113387	578-6	G 1	16.0	110.5	48.0

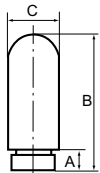

Plastic silencers

Polyethylene

EASY

Important: The air flowing through the silencer is cooled down; at temperatures below zero, the moisture in the air can freeze, causing the pores of the silencer to close up.

Max. operating pressure	6 bar
Operating temperature	5 to 80 °C



566-2

Silencer, polyethylene

Art. No.	Type No.	Thread	Max. pore size μm	A mm	B mm	C mm
113320	566-0	M5	35	5.0	25.0	7.0
113321	566-1	G 1/8	50	7.0	32.0	13.0
113322	566-2	G 1/4	50	8.0	39.0	17.0
101242	566-3	G 3/8	50	11.0	65.0	25.0
113323	566-4	G 1/2	50	11.5	70.0	25.0
113324	566-5	G 3/4	50	15.5	138.0	37.0
113325	566-6	G 1	50	19.5	158.0	48.0

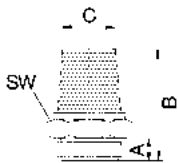

Sintered bronze silencers

EASY

For reducing the exhaust noise generated by pneumatic equipment.

Max. operating pressure	8 bar
Operating temperature	-10 to 250 °C
Noise level at 6 bar	71 to 108 dB



567-2/M

Silencer, sintered bronze, with brass hexagon nut and brass thread

Art. No.	Type No.	Thread	a/f mm	A mm	B mm	C mm
113344	567-0/M	M5	9	5.0	18.5	4.0
113345	567-1/M	G 1/8	12	4.5	21.0	8.5
100290	567-2/M	G 1/4	15	6.0	28.0	11.0
113346	567-3/M	G 3/8	19	7.0	35.5	14.0
100292	567-4/M	G 1/2	23	8.0	41.5	16.0
100293	567-5/M	G 3/4	30	9.0	53.0	21.0
113347	567-6/M	G 1	36	12.0	67.0	27.0

Sintered bronze silencers

EASY

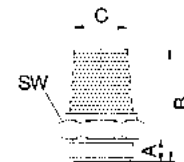

Silencer, sintered bronze, flat type with male thread

Art. No.	Type No.	Thread	a/f mm	A mm	B mm	C mm
113333	569-0	M5	8	4.0	8.0	7.8
113334	569-1	G 1/8	13	6.0	13.0	12.8
101471	569-2	G 1/4	15	7.5	16.5	14.8
113335	569-3	G 3/8	19	7.5	16.5	18.8
101472	569-4	G 1/2	24	9.0	18.5	23.0
113336	569-5	G 3/4	27	11.0	19.5	26.0
113337	569-6	G 1	36	14.0	24.0	35.0



569-2

→ The use of silencers does not automatically reduce exhaust noise to a safe level. The need for other noise-reducing measures, such as hearing protection, must be assessed as well.

Sintered bronze silencers

EASY

For reducing the exhaust noise generated by pneumatic equipment.

Max. operating pressure	10 bar
Operating temperature	-10 to 250 °C
Standard thread	G thread acc. to DIN EN ISO 228-1

Silencer, sintered bronze, slotted

Art. No.	Type No.	Thread	A mm	B mm	C mm
113353	564-1	G 1/8	6.5	12.5	9.5
100289	564-2	G 1/4	6.5	13.5	12.6
113354	564-3	G 3/8	7.5	16.0	16.2
100291	564-4	G 1/2	10.0	19.6	20.5
113355	564-5	G 3/4	11.0	23.0	26.0
113356	564-6	G 1	13.0	24.0	33.0



564-2

Silencer, sintered bronze, flat type with female thread

Art. No.	Type No.	Thread	a/f mm	B mm	C mm
113357	565-0	M5	8	8.0	5.0
113358	565-1	G 1/8	13	10.0	9.0
113359	565-2	G 1/4	16	11.0	11.0
113360	565-3	G 3/8	19	12.0	15.0
113361	565-4	G 1/2	24	13.0	20.0
113362	565-5	G 3/4	32	18.0	28.0
113363	565-6	G 1	41	22.0	37.0



565-2

→ The use of silencers does not automatically reduce exhaust noise to a safe level. The need for other noise-reducing measures, such as hearing protection, must be assessed as well.



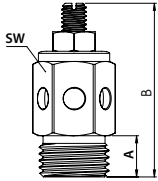

Sintered bronze silencers

Sintered damper element, brass housing, adjustable

EASY

Max. operating pressure 15 bar
Operating temperature -10 to 250 °C



SD14MSEB

Silencer, sintered bronze. brass housing, adjustable

Art. No.	Type No.	Thread	a/f mm	A mm	B mm
156513	SD18MSEB	G 1/8	13	6.5	29.0
156514	SD14MSEB	G 1/4	14	8.5	36.0
156515	SD38MSEB	G 3/8	17	10.0	42.0
156516	SD12MSEB	G 1/2	22	10.5	44.0
156517	SD34MSEB	G 3/4	27	13.5	55.0
156518	SD1MSEB	G 1	34	15.5	64.0

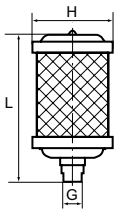

High-performance silencers

EASY

Housing Aluminium
Material Steel zinc plated perforated plane
Max. working pressure 10 bar
Operating temperature -10 to 70 °C
Noise reduction ≥ 20 dB



LX 05

High-performance silencer

Art. No.	Type No.	Thread	Flow rate at 6 bar l/min	Muffling material	L mm	H mm
113304	LX 01	G 1/8	1240	Sintered PE	80.0	47.0
113305	LX 02	G 1/4	2370	Sintered PE	111.0	47.0
113306	LX 03	G 3/8	5430	Sintered PE	130.0	66.0
113307	LX 05	G 1/2	7240	Sintered PE	148.0	80.0
113308	LX 07	G 3/4	15400	Sintered PE	184.0	86.5
113309	LX 10	G 1	22600	Sintered PE	222.0	99.0
113310	LX 12	G 1 1/4	38500	Sintered PE	226.0	99.0
113311	LX 15	G 1 1/2	58900	Cotton cloth inlay	340.0	133.5
113312	LX 20	G 2	90600	Cotton cloth inlay	470.0	133.5

High-performance silencers

PLUS

Multi-chamber silencers with a high blow-off rate, short exhaust time and excellent silencing effect.

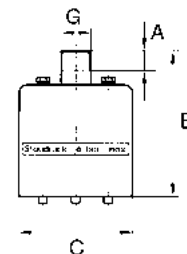

570-1



572

Housing	Galvanized steel housing
Material	Perforated sheet galvanized steel, polyester felt discs
Max. input pressure	6 bar
Operating temperature	-10 to 90 °C
Mounting position	Any

High-performance silencer

Art. No.	Type No.	Thread	Flow rate at 6 bar l/min	A mm	B mm	C mm
113295	570-1	G 1/2	13350	14.0	103.0	80.0
113296	570-2	G 3/4	16700	16.0	106.0	80.0
113297	570-3	G 1	23350	18.0	130.0	110.0
113298	570-4	G 1 1/4	31700	20.0	136.0	110.0
113299	570-5	G 1 1/2	53400	24.0	168.0	150.0
113300	570-6	G 2	56700	24.0	168.0	150.0

→ The use of silencers does not automatically reduce exhaust noise to a safe level. The need for other noise-reducing measures, such as hearing protection, must be assessed as well.

Replacement felt discs, set of 3

Art. No.	Type No.	Description
113301	572	Set of 3 discs for sizes G 1/2 to G 3/4
113302	574	Set of 3 discs for sizes G 1 to G 1 1/4
113303	576	Set of 3 discs for sizes G 1 1/2 to G 2

Sintered bronze silencers

PLUS

For reducing the exhaust noise generated by pneumatic equipment.

Max. operating pressure	8 bar
Operating temperature	-10 to 250 °C
Noise level at 6 bar	71 to 108 dB

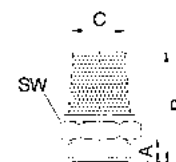

567-2

Silencer, sintered bronze, with hexagon nut

Art. No.	Type No.	Thread	a/f mm	A mm	B mm	C mm
113338	567-1	G 1/8	13	6.0	28.0	8.0
113339	567-2	G 1/4	17	8.0	34.0	12.0
113340	567-3	G 3/8	22	10.0	36.0	15.0
113341	567-4	G 1/2	27	12.0	44.0	19.0
113342	567-5	G 3/4	32	14.0	54.0	22.0
113343	567-6	G 1	41	16.0	66.0	28.0

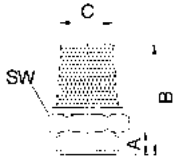

568-2

Sintered bronze silencers

PLUS

Silencer, sintered bronze, slotted

Art. No.	Type No.	Thread	A mm	B mm	C mm
113348	568-1	G 1/8	5.5	21.0	8.0
100405	568-2	G 1/4	8.5	27.0	10.0
113349	568-3	G 3/8	11.0	36.0	15.0
113350	568-4	G 1/2	11.0	44.0	19.0
113351	568-5	G 3/4	12.0	65.0	20.0
113352	568-6	G 1	15.0	75.0	26.5

→ The use of silencers does not automatically reduce exhaust noise to a safe level. The need for other noise-reducing measures, such as hearing protection, must be assessed as well.

Sintered bronze silencers

PLUS

For reducing the exhaust noise generated by pneumatic equipment.

Max. operating pressure	10 bar
Operating temperature	-10 to 250 °C
Standard thread	G thread acc. to DIN EN ISO 228-1



560-2

Silencer, sintered bronze, flat type with male thread

Art. No.	Type No.	Thread	B mm	C mm
113364	560-1	G 1/8	6.0	6.0
113365	560-2	G 1/4	6.0	8.0
113366	560-3	G 3/8	6.5	10.0
113367	560-4	G 1/2	8.0	12.0
113368	560-5	G 3/4	10.5	20.0
113369	560-6	G 1	9.5	26.0

→ The use of silencers does not automatically reduce exhaust noise to a safe level. The need for other noise-reducing measures, such as hearing protection, must be assessed as well.

Sintered bronze silencers

adjustable

PLUS

The volume of exhaust air can be set by means of an adjusting screw with a lock nut.

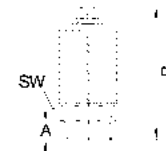

Max. operating pressure	10 bar
Operating temperature	-10 to 250 °C

Silencer, sintered bronze/brass, exhaust air adjustable with lock nut

Art. No.	Type No.	Thread	a/f mm	A mm	B min. mm	B max. mm
113313	563-0	M5	8	4.0	21.0	28.0
113314	563-1	R 1/8	16	8.0	38.0	48.0
113315	563-2	R 1/4	16	9.5	39.5	49.5
113316	563-3	R 3/8	22	10.5	47.5	60.5
113317	563-4	R 1/2	22	12.0	49.0	62.0
113318	563-5	R 3/4	30	12.0	75.4	90.0
113319	563-6	R 1	36	14.5	75.9	90.5



563-2

→ The use of silencers does not automatically reduce exhaust noise to a safe level. The need for other noise-reducing measures, such as hearing protection, must be assessed as well.

Silencers

Adjustable spring

PLUS

Max. operating pressure	12 bar
Operating temperature	-10 to 80 °C

Adjustable spring silencer

Art. No.	Type No.	Thread	a/f mm	A mm	B min. mm	B max. mm
113370	561.1	G 1/8	13	12.0	26.0	28.0
113371	561.2	G 1/4	15	14.0	30.0	32.0
113372	561.3	G 3/8	22	17.0	36.0	38.0
113373	561.4	G 1/2	22	17.0	37.0	39.0
113374	561.5	G 3/4	30	32.0	46.0	50.0
113375	561.6	G 1	36	32.0	47.0	50.0

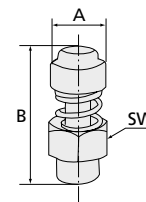

561.1

→ The use of silencers does not automatically reduce exhaust noise to a safe level. The need for other noise-reducing measures, such as hearing protection, must be assessed as well.





Stainless steel silencers

material 1.4401

Max. operating pressure 8 bar
 Operating temperature -10 to 250 °C
 Standard thread G thread acc. to DIN EN ISO 228-1



562-2 ES

Schalldämpfer aus Edelstahl

Artikel Nr.	Typen Nr.	Gewinde	SW mm	A mm	B mm
113326	562-0 ES	M5	9	5,0	21,0
113327	562-1 ES	G 1/8	12	7,0	29,0
113328	562-2 ES	G 1/4	15	9,0	33,0
113329	562-3 ES	G 3/8	19	9,0	39,0
113330	562-4 ES	G 1/2	23	9,5	48,0
113331	562-5 ES	G 3/4	30	11,0	58,0
113332	562-6 ES	G 1	36	15,0	71,0

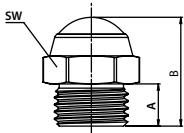

Stainless steel silencers

flat type

Max. operating pressure 15 bar
 Operating temperature -10 to 250 °C



SD14ESFL

Silencer, stainless steel, flat type

Art. No.	Type No.	Thread	a/f mm	A mm	B mm
156485	SD5ESFL	M5	8	5.0	11.5
156486	SD18ESFL	G 1/8	13	6.0	15.0
156487	SD14ESFL	G 1/4	16	8.0	19.0
156488	SD38ESFL	G 3/8	19	8.0	19.5
156489	SD12ESFL	G 1/2	24	10.0	22.0
156490	SD34ESFL	G 3/4	30	10.0	25.5
156491	SD1ESFL	G 1	36	11.5	27.0

Stainless steel silencers

Sintered damper element, adjustable

Max. operating pressure 20 bar
 Operating temperature -10 to 600 °C
 Material Stainless steel 1.4401

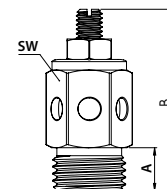

Silencer, sintered stainless steel, stainless steel housing, adjustable

Art. No.	Type No.	Thread	a/f mm	A mm	B mm
156524	SD18ESEB	G 1/8	13	6.0	29.0
156525	SD14ESEB	G 1/4	14	8.5	35.5
156526	SD38ESEB	G 3/8	17	10.0	38.0
156527	SD12ESEB	G 1/2	22	10.5	42.5
156528	SD34ESEB	G 3/4	27	13.5	49.5
156529	SD1ESEB	G 1	34	15.5	51.5





WITH

EVERYTHING

THAT GOES

WITH IT.

PA / PUR / PE hoses

 Polyethylene hose (LD-PE)
Page 820-821

 Polyurethane hose (PUR)
Page 822-823

 Polyurethane-DUO-hose
Page 824

 Polyamide hose (PA 12 HIPHL)
Page 824-826

 Polyamide-DUO-hose
Page 827

 Hose cutters
Page 827-828

PVC hoses

 PVC air hose kits
Page 833

 PVC braided hose, fluorescent green
Page 833

 PVC safety air hose kits
Page 834

 Male connectors for PVC braided hoses
Page 834

 Special PVC pneumatic hose
Page 835

 Male connectors for special PVC pneumatic hose
Page 835

Spirals hoses kits

 Spiral hose and coupling kits anti-spark type
Page 841

 Spiral hose and blow gun kits
Page 841

 Spiral hose and blow gun kits »Typhoon«
Page 841

 PUR hose and coupling kits
Page 842

PVC hoses

 PVC hose
Page 829

 Workshop hose soft PVC
Page 830

 Soft PVC air hose kits
Page 830-831

 Workshop hose soft PVC - oil resistant
Page 831

 PVC braided hose
Page 832

Spiral hoses

 Polyamide
Page 836-837

 Adapters with kink protector
Page 837-839

 Polyurethane
Page 839-840

 Swivel adapters
Page 840

Hoses

 Compressed air and water hose
Page 843

 Industrial water hoses
Page 843

 Water hose
Page 844

 Drinking water hose
Page 844

 Salt and hot water hose
Page 845

 PTFE hoses
Page 845

 Electrically conductive hose
Page 846



Hoses

 Anti-spark PU hose
Page 846

 Braided PUR hose
Page 847

 Oxyacetylene hose
Page 847

 Suction and discharge hoses
Page 848

 Suction and discharge hoses heavy duty type
Page 848

 Rubber suction and discharge hoses
Page 849

 Dekabon tubes
Page 850

Tube protections

 Vibration dampers
Page 851

 Hose security cable
Page 851

 Hose rupture valves
Page 852

Hose winders

 Standard type, compressed air and water
Page 853

 compact type
Page 853

 for compressed air and water, lightweight type
Page 854

 for compressed air
Page 854

 for compressed air, high flow capacity
Page 855

 for compressed air, anti-spark
Page 855

 for water
Page 856

 for compressed air and water, heavy-duty type
Page 856

 welding type
Page 857

 Compressed air hose reel
Page 857

 for mobile applications
Page 857

Electric cable winder

 POM
Page 858

 Polypropylen
Page 858

Hose holder

 Aluminium
Page 859

Compressed air system »speedfit« and »sharkbite«

 Plastic pipes straight lengths, PA 12 »speedfit« and »sharkbite«
Page 860

 Plastic pipes on coils, PA 12 »speedfit« and »sharkbite«
Page 861

 Aluminium pipes »speedfit« and »sharkbite«
Page 861

 Plastic pipes, LLDPE/LDPE »speedfit« and »sharkbite«
Page 862

 Push-in fittings (POM) »speedfit«
Page 862-868

 Accessories »speedfit«
Page 868-869

 Brass unions »speedfit«
Page 870

**Compressed air system
»speedfit« and »sharkbite«**

 Brass unions »sharkbite«
Page 870-872

 Ball valves »sharkbite«
Page 872

 End caps »sharkbite«
Page 872

 Pipe clips »speedfit«
Page 874

 Pipe clips »speedfit« and »sharkbite«
Page 874

 Porting boxes »speedfit«
Page 874

 Porting boxes »speedfit« and »sharkbite«
Page 875

 Brass unions »speedfit« and »sharkbite«
Page 875

 Accessories »speedfit« and »sharkbite«
Page 875

Sealing materials

 Sealing rings
Page 876-877

Sealing materials

 PTFE sealing tape
Page 877

 Thread sealant
Page 877

Hose clips

 Two-ear hose clips
Page 878

 One-ear hose clips
Page 879

 One-ear hose clips with insert ring
Page 879-880

 Clamping jaws
Page 881

 Hose clips
Page 881-883

 Boxed sets, hose clamps
Page 884

 Hinge bolt clamps
Page 885-886

 RSGU pipe retaining clips
Page 887

Blow guns

 Blow guns die-cast aluminium, nickel-plated, standard type
Page 888

 Blow guns die-cast aluminium, nickel-plated
Page 889

 Blow guns aluminium
Page 889

 Safety nozzles, for standard blow guns
Page 890

 Nozzle
Page 890

 Air flow nozzle
Page 891

 Extension nozzles
Page 891

 Plastic blow guns
Page 891

 Blow guns
Page 892-893

 Blow guns plastic
Page 893

 Blow guns with pressure regulator, plastic
Page 894



Blow guns



Blow gun holder
Page 895



Blow-off valves
Page 895



High-volume blow guns
»Typhoon Plus«
Page 896



High-volume blow guns
Page 897



Accessories for Typhoon
high-volume blow guns
Page 897-898



High-volume blow guns
»Typhoon Plus«
Page 899



Safety nozzles,
for high-volume blow guns
Page 900



Screw adapter for blow guns
Page 900



Safety nozzles,
for universal applications
Page 901



Mini pressure regulators
Page 902



Spray guns
Page 902

Blow guns



Professional industrial
spray gun
Page 903

Handheld tyre gauges



Pistol shape
Page 904



Standard type in pistol shape
Page 904



standard type
Page 905



Digital handheld tyre gauge
Page 906



Tyre gauges
Page 907

Industrial adhesives and technical sprays



Industrial adhesives
Page 908-910



Technical sprays
Page 910-914



Surface and corrosion
inhibiting sprays
Page 914-915

Repair Sticks



Repair Sticks
Page 916-917

Receptacle combinations



Type »aircube«
Page 918



Type »cube«
Page 918



Type »3-Kraft«
Page 919



Type »aircraft«
Page 919

Notes











A large grid of small dots for taking notes, covering the majority of the page.



Model	max. operating pressure (PN) at 20 °C [bar]	Temperature range at 20 °C [°C]	Compressed air	Water	Non-toxic and non-aggressive gases and liquids
Polyethylene hose LD-PE	6 - 21 (depending on diameter)	-40 to 60	•	•	•
Polyurethane hose / PU	7 - 22 (depending on diameter)	-40 to 60	•	•	•
Polyurethane hose DUO / PUR	9 - 21 (depending on diameter)	-35 to 60	•	•	•
Polyamide hose PA12	19 - 27 (depending on diameter)	-40 to 80	•	•	•
Polyamide DUO hose PA12	19 - 27 (depending on diameter)	-60 to 100	•	•	•
PVC hose	3,5 - 13 (depending on diameter)	-15 to 60	•	•	•
Workshop hose soft PVC	15	-20 to 60	•	•	
Workshop hose soft PVC, oil resistant	16	-20 to 60	•	•	•
Braided hose	3,75 - 22,5 (depending on diameter and medium)	-20 to 60	•	•	•
PVC special pneumatic hose	28 - 40 (depending on diameter)	-10 to +60	•	•	•
Compressed air and water hose	20	-20 to 60	•	•	
Industrial water hose	10	-30 to 80	•	•	
Water hose	6 - 8 (depending on diameter)	-15 to 60	•	•	
Potable water hose	20	-15 to 50	•	•	
Salt and hot water hose	20	-40 to 100		•	
PTFE hose	14 - 42 (depending on diameter)	-60 to 260	•	•	•
Anti-static hose	6,21 - 7,24 (depending on diameter, at 25 °C)	-40 to 70	•	•	
Spark erosion protected PU hose	5 - 12	-40 to 70	•	•	•
PUR hose, braid reinforced	12 - 16 (depending on diameter)	-30 to 60	•	•	•
Autogenous hose	20	-20 to 60	•	•	
Suction and pressure hose lightweight design	4 - 6 (depending on diameter)	-15 to 60	•	•	•
Suction and pressure hose heavy duty design	3 - 10 (depending on diameter)	-15 to 60	•	•	•
Suction and pressure hose type »Heduflex®«	10	-30 to 80	•	•	•

Oil	Potable water (DVGW approval)	Liquid manure or light acids and alkalis	Aliphatic hydrocarbons	Oxygen	Features	From page
•			•		Soft and flexible character, relatively high strength and good stress crack resistance, suitable for vacuum up to 10x8 mm	820
•			•	•	Flexible and high abrasion resistance, very good low temperature flexibility, minimal permanent deformation when subjected to long-term stresses.	822
•			•	•		824
•					Compressed air brake systems in motor vehicles and trailers (DIN 73378: 1996-02 and DIN 74324-1:1996-02)	824
•						827
		•			Unique in its versatility for unpressurised carrying of various liquids, food quality according to Regulation (EC) no.10/2011	829
					High pressure resistance, high mechanical strength, durable	830
•					For high demands, very good flexibility at low temperatures, very durable against mechanical stresses	831
					Flexible, pressure resistant and abrasion resistant, food quality according to Regulation (EC) no. 10/2011, durable, increased UV protection	832
•		•			Braid made of impregnated special textile for higher pressures	835
					Hose cover is resistant against temporary influence of oil, non-abrasive and weatherproof	843
		•				843
					Multi-layer hose structure with polyester fabric insert	844
	•				Complies with the KTW guidelines of the German Federal Environmental Agency acc. to Cat. "A" and the DVGW Worksheet W270	844
						845
					Low coefficient of friction	845
					Set as electrically conducting (electrically conductive)	846
•		•			Protects against welding sparks, flexible, bendable	846
•			•	•		847
					Flexible acc. to design DIN EN ISO 3821:2010	847
					With green shockproof hard PVC spiral	848
		•			Made of transparent plastic with embedded steel wire spiral, acc. to Directive 2007/19/EC	848
		•			Made of rubber with embedded steel wire spiral	849



Model	Type no.	Material		Hose length [m]	Hose – Ø [mm]
		Base body material	Hose		
	275.09 276.12	Plastic	Polyurethane	9 to 12	8x12
	259/4010	Polypropylene	Polyurethane	7	8x12
	SAR8M.15B.R14R38 SAR15M.15B.R14	Polypropylene	PVC	8 to 15	8x12 to 6,5x12
	259/5120-1 259/5100-1 259/5000-1 259/4900-1 259/4000-1	POM	Fabric reinforced polyurethane	7 to 17	8x12 to 11x16
	259/5130-1	POM	Fabric reinforced, spark erosion protected polyurethane	14	9,5x13,5
	259/4400-1	POM	Fabric reinforced PVC	14	9,5x13
	259/6020 259/6021 259/6022 259/6023	Steel, powder coated	Polyurethane	10 to 20	6,5x10 to 11x16
	259/7501	Steel, powder coated	Rubber, synthetic	15	O2: 6x16,5 Acetylen: 10x17
	190/226 190/229	Plastic	PVC braided hose	20	6x12 to 9x15
	259/4050	Steel, anodised	Polyurethane	50	8x12

Medium

max. operating pressure [bar]	Temperature range [°C]	Compressed air	Water	Oxygen / Acetylene	Pivoting range	From page
10 to 15	max. 40	•	•		150°	853
10	-10 to 40	•			180°	853
15	max. 60	•	•		180°	854
12 to 16	-20 to 60	•			180°	854
12	-20 to 60	•			180°	855
9	5 to 60		•		180°	856
10	-10 to 40	•	•			856
10				•		857
		•				857
10	-10 to 40	•				857



Polyethylene hose - LD-PE

EASY

Low-priced, calibrated hose for use with screw fittings.

With its soft and flexible character, combined with relatively high strengths and good resistance to stress cracking, this hose is ideal for use in the following types of application:

- Flexible pneumatic lines in the low-pressure range, providing no special resistance to greases, oils or other hydrocarbons is required.
- Compressed air control lines.
- Vacuum lines (suitable for vacuum up to 10 x 8 mm).
- Supply lines of all kinds.

Temperature range -40 to 60 °C



Polyethylene hose - LD-PE

Art. No.	Type No.	Tube O.D. mm	Tube I.D. mm	Wall thickness mm	Max. operating pressure at 23 °C bar	Colour
194221	259.40 N-V2	3	1.5	0.75	17	natural
194222	259.05 N-V2	4	2	1	18	natural
194223	259.05 B-V2	4	2	1	18	blue
194224	259.05 G-V2	4	2	1	18	yellow
194225	259.05 R-V2	4	2	1	18	red
194226	259.05 S-V2	4	2	1	18	black
194230	259.00-N-V2	5	3	1	13	natural
194231	259.00-B-V2	5	3	1	13	blue
194232	259.00-G-V2	5	3	1	13	yellow
194233	259.00-R-V2	5	3	1	13	red
194234	259.00-S-V2	5	3	1	13	black
194235	259.01-N-V2	6	4	1	10	natural
194236	259.01-B-V2	6	4	1	10	blue
194237	259.01-G-V2	6	4	1	10	yellow
194238	259.01-R-V2	6	4	1	10	red
194239	259.01-S-V2	6	4	1	10	black
194243	259.02-N-V2	8	6	1	8	natural
194244	259.02-B-V2	8	6	1	8	blue
194245	259.02-G-V2	8	6	1	8	yellow
194246	259.02-R-V2	8	6	1	8	red
194247	259.02-S-V2	8	6	1	8	black
194251	259.03-N-V2	10	8	1	6	natural
194252	259.03-B-V2	10	8	1	6	blue
194253	259.03-G-V2	10	8	1	6	yellow
194254	259.03-S-V2	10	8	1	6	black
194255	259.03-R-V2	10	8	1	6	red
194259	259.43 N-V2	12	9	1.5	8	natural
194260	259.43 B-V2	12	9	1.5	8	blue
194261	259.43 G-V2	12	9	1.5	8	yellow
194262	259.43 R-V2	12	9	1.5	8	red
194263	259.43 S-V2	12	9	1.5	8	black
194264	259.23 N-V2	12	10	1	5	natural
194265	259.23 B-V2	12	10	1	5	blue
194266	259.23 G-V2	12	10	1	5	yellow
194267	259.23 R-V2	12	10	1	5	red
194268	259.23 S-V2	12	10	1	5	black
194269	259.41 N-V2	14	10	2	8	natural
194270	259.41 B-V2	14	10	2	8	blue
194271	259.41 G-V2	14	10	2	8	yellow
194272	259.41 R-V2	14	10	2	8	red
194273	259.41 S-V2	14	10	2	8	black

Polyethylene hose - LD-PE

EASY

Polyethylene hose - LD-PE						
Art. No.	Type No.	Tube O.D. mm	Tube I.D. mm	Wall thickness mm	Max. operating pressure at 23 °C bar	Colour
194274	259.42 N-V2	16	12	2	7	natural
194275	259.42 B-V2	16	12	2	7	blue
194276	259.42 S-V2	16	12	2	7	black

Polyethylene hose - LD-PE, roll of 100 m, packed in a paper box						
Art. No.	Type No.	Tube O.D. mm	Tube I.D. mm	Wall thickness mm	Max. operating pressure at 23 °C bar	Colour
194227	259.05 N-100-V2	4	2	1	18	natural
194228	259.05 B-100-V2	4	2	1	18	blue
194229	259.05 S-100-V2	4	2	1	18	black
194240	259.01-N-100-V2	6	4	1	10	natural
194241	259.01-B-100-V2	6	4	1	10	blue
194242	259.01-S-100-V2	6	4	1	10	black
194248	259.02-N-100-V2	8	6	1	8	natural
194249	259.02-B-100-V2	8	6	1	8	blue
194250	259.02-S-100-V2	8	6	1	8	black
194256	259.03-N-100-V2	10	8	1	6	natural
194257	259.03-B-100-V2	10	8	1	6	blue
194258	259.03-S-100-V2	10	8	1	6	black



Polyurethane hose (PUR)

MAX

Polyurethane hoses are renowned for their extreme flexibility and correspondingly narrow bending radius across a wide temperature range.

They are more flexible even than LD-PE hoses and exhibit good abrasion resistance, very good low-temperature flexibility, only minimal permanent deformation when subjected to long-term stresses as well as good resistance to the majority of oils, greases, aliphatic hydrocarbons and oxygen.

Main applications:

- Pneumatic and hydraulic (miniature hydraulics) lines
- Mechanical engineering
- Engine construction
- Instrumentation and control
- Ideal for use with unions, as externally calibrated

Temperature range -20 to 60 °C



Polyurethane hose (PUR)

Art. No.	Type No.	Tube O.D. mm	Tube I.D. mm	Wall thickness mm	Max. operating pressure at 23 °C bar	Colour
113646	259.50 N	3	1.5	0.75	13	Natural
113647	259.50 B	3	1.5	0.75	13	Blue
113648	259.50 S	3	1.5	0.75	13	Black
113649	259.04 N	4	2	1	16	Natural
113650	259.04 B	4	2	1	16	Blue
113651	259.04 G	4	2	1	16	Yellow
113652	259.04 R	4	2	1	16	Red
113653	259.04 S	4	2	1	16	Black
113654	259.04 GR	4	2	1	16	Green
113655	259.04 SI	4	2	1	16	Silver
113656	259.15 N	5	3	1	13	Natural
113657	259.15 B	5	3	1	13	Blue
113660	259.15 S	5	3	1	13	Black
113663	259.16 N	6	4	1	11	Natural
113664	259.16 B	6	4	1	11	Blue
113665	259.16 G	6	4	1	11	Yellow
113666	259.16 R	6	4	1	11	Red
113667	259.16 S	6	4	1	11	Black
113668	259.16 GR	6	4	1	11	Green
113669	259.16 SI	6	4	1	11	Silver
154878	259.63 N	8	5	1.5	10	Natural
154879	259.63 B	8	5	1.5	10	Blue
154880	259.63 S	8	5	1.5	10	Black
113670	259.17 N	8	6	1	10	Natural
113671	259.17 B	8	6	1	10	Blue
113672	259.17 G	8	6	1	10	Yellow
113673	259.17 R	8	6	1	10	Red
113674	259.17 S	8	6	1	10	Black
113675	259.17 GR	8	6	1	10	Green
113676	259.17 SI	8	6	1	10	Silver
154881	259.64 N	10	7	1.5	10	Natural
154882	259.64 B	10	7	1.5	10	Blue
154883	259.64 S	10	7	1.5	10	Black

Polyurethane hose (PUR)

MAX

Polyurethane hose (PUR)						
Art. No.	Type No.	Tube O.D. mm	Tube I.D. mm	Wall thickness mm	Max. operating pressure at 23 °C bar	Colour
113677	259.18 N	10	8	1	7	Natural
113678	259.18 B	10	8	1	7	Blue
113679	259.18 G	10	8	1	7	Yellow
113680	259.18 R	10	8	1	7	Red
113681	259.18 S	10	8	1	7	Black
113682	259.18 GR	10	8	1	7	Green
113683	259.18 SI	10	8	1	7	Silver
154884	259.65 N	12	8	2	10	Natural
154885	259.65 B	12	8	2	10	Blue
154886	259.65 S	12	8	2	10	Black
113684	259.20 N	12	9	1.5	8	Natural
114591	259.20 B	12	9	1.5	8	Blue
114592	259.20 G	12	9	1.5	8	Yellow
113687	259.20 R	12	9	1.5	8	Red
113688	259.20 S	12	9	1.5	8	Black
113689	259.20 GR	12	9	1.5	8	Green
113690	259.20 SI	12	9	1.5	8	Silver
113692	259.51 B	14	10	2	7	Blue
113693	259.51 S	14	10	2	7	Black
113695	259.52 N	16	12	2	8	Natural
113696	259.52 S	16	12	2	8	Black

Polyurethane hose (PUR), roll of 100 m, packed in a paper box						
Art. No.	Type No.	Tube O.D. mm	Tube I.D. mm	Wall thickness mm	Max. operating pressure at 23 °C bar	Colour
113698	259.04 N-100	4	2	1	16	Natural
113699	259.04 B-100	4	2	1	16	Blue
113700	259.04 S-100	4	2	1	16	Black
113701	259.16 N-100	6	4	1	11	Natural
113702	259.16 B-100	6	4	1	11	Blue
113703	259.16 S-100	6	4	1	11	Black
113704	259.17 N-100	8	6	1	10	Natural
113705	259.17 B-100	8	6	1	10	Blue
113706	259.17 S-100	8	6	1	10	Black
113707	259.18 N-100	10	8	1	7	Natural
113708	259.18 B-100	10	8	1	7	Blue
113709	259.18 S-100	10	8	1	7	Black
113710	259.20 N-100	12	9	1.5	8	Natural
113711	259.20 B-100	12	9	1.5	8	Blue
113712	259.20 S-100	12	9	1.5	8	Black



Polyurethane DUO hose

MAX

Polyurethane hoses are renowned for their extreme flexibility and correspondingly narrow bending radius across a wide temperature range.

They exhibit good abrasion resistance, very good low-temperature flexibility, only minimal permanent deformation when subjected to long-term stresses as well as good resistance to oils, greases, aliphatic hydrocarbons and oxygen.
Suitable for vacuum.

Temperature range	-35 to 60 °C
Colour	Blue / black



259.16-DUO

DUO hose, polyurethane

Art. No.	Type No.	Tube O.D. mm	Tube I.D. mm	Max. operating pressure at 20 °C bar	Reel length m
113713	259.04-DUO	4	2	21	25
113714	259.15-DUO	5	3	16	25
113715	259.16-DUO	6	4	14	25
113716	259.17-DUO	8	6	12	25
113717	259.18-DUO	10	8	9	25

Polyamide hose - PA 12 HIPHL

MAX

PA 12 has a low water absorptive capacity and is therefore dimensionally stable if the ambient humidity varies.
PA 12 resists greases, oil, fuels, hydraulic fluids, alkalis and salt solutions.

Sufficient UV resistance can only be guaranteed if the material is pigmented black!

Suitable for use with push-in fittings as externally calibrated. Suitable for vacuum up to 12 x 9 mm.

Main applications:

- Compressed air lines (low-pressure range) in industry and manual trades.
- Hydraulic lines (miniature hydraulics) in instrumentation and control.
- Lines for liquid and free-flowing substances.
- Pneumatic braking systems in motor vehicles and trailers (DIN 73378:1996-02 and DIN 74324-1:1996-02).
- Fuel and lubricant supply systems.
- Vacuum lines

Temperature range	-40 to 130 °C
-------------------	---------------



Polyamide hose - PA 12 HIPHL

Art. No.	Type No.	Tube O.D. mm	Tube I.D. mm	Wall thickness mm	Max. operating pressure at 23 °C bar	Colour
194136	259.08 N-V2	3	1.5	0.75	49	natural
194137	259.08 B-V2	3	1.5	0.75	49	blue
194138	259.08 S-V2	3	1.5	0.75	49	black
194139	259.09 N-V2	4	2	1	49	natural
194140	259.09 B-V2	4	2	1	49	blue
194141	259.09 G-V2	4	2	1	49	yellow
194142	259.09 R-V2	4	2	1	49	red
194143	259.09 S-V2	4	2	1	49	black
194144	259.09 GR-V2	4	2	1	49	green
194145	259.09 SI-V2	4	2	1	49	silver

Polyamide hose - PA 12 HIPHL

MAX

Polyamide hose - PA 12 HIPHL						
Art. No.	Type No.	Tube O.D. mm	Tube I.D. mm	Wall thickness mm	Max. operating pressure at 23 °C bar	Colour
194149	259.07 N-V2	4.3	3	0.65	28	natural
194150	259.07 B-V2	4.3	3	0.65	28	blue
194151	259.07 S-V2	4.3	3	0.65	28	black
194152	259.10 N-V2	5	3	1	37	natural
194153	259.10 B-V2	5	3	1	37	blue
194154	259.10 G-V2	5	3	1	37	yellow
194155	259.10 R-V2	5	3	1	37	red
194156	259.10 S-V2	5	3	1	37	black
194157	259.10 GR-V2	5	3	1	37	green
194158	259.10 SI-V2	5	3	1	37	silver
194159	259.11 N-V2	6	4	1	29	natural
194160	259.11 B-V2	6	4	1	29	blue
194161	259.11 G-V2	6	4	1	29	yellow
194162	259.11 R-V2	6	4	1	29	red
194163	259.11 S-V2	6	4	1	29	black
194164	259.11 GR-V2	6	4	1	29	green
194165	259.11 SI-V2	6	4	1	29	silver
194169	259.12 N-V2	8	6	1	21	natural
194170	259.12 B-V2	8	6	1	21	blue
194171	259.12 G-V2	8	6	1	21	yellow
194172	259.12 R-V2	8	6	1	21	red
194173	259.12 S-V2	8	6	1	21	black
194174	259.12 GR-V2	8	6	1	21	green
194175	259.12 SI-V2	8	6	1	21	silver
194179	259.61 N-V2	10	7	1.5	26	natural
194180	259.61 B-V2	10	7	1.5	26	blue
194181	259.61 S-V2	10	7	1.5	26	black
194182	259.13 N-V2	10	8	1	16	natural
194183	259.13 B-V2	10	8	1	16	blue
194184	259.13 G-V2	10	8	1	16	yellow
194185	259.13 R-V2	10	8	1	16	red
194186	259.13 S-V2	10	8	1	16	black
194187	259.13 GR-V2	10	8	1	16	green
194188	259.13 SI-V2	10	8	1	16	silver
194192	259.14 N-V2	12	9	1.5	21	natural
194193	259.14 B-V2	12	9	1.5	21	blue
194194	259.14 G-V2	12	9	1.5	21	yellow
194195	259.14 R-V2	12	9	1.5	21	red
194196	259.14 S-V2	12	9	1.5	21	black
194197	259.14 GR-V2	12	9	1.5	21	green
194198	259.14 SI-V2	12	9	1.5	21	silver
194202	259.22 N-V2	12	10	1	13	natural
194203	259.22 B-V2	12	10	1	13	blue
194204	259.22 G-V2	12	10	1	13	yellow
194205	259.22 R-V2	12	10	1	13	red
194206	259.22 S-V2	12	10	1	13	black
194207	259.22 GR-V2	12	10	1	13	green
194208	259.22 SI-V2	12	10	1	13	silver
194209	259.62 N-V2	14	11	1.5	17	natural
194210	259.62 B-V2	14	11	1.5	17	blue
194211	259.62 S-V2	14	11	1.5	17	black



Polyamidschlauch - PA 12 HIPHL

MAX
Polyamide hose - PA 12 HIPHL

Art. No.	Type No.	Tube O.D. mm	Tube I.D. mm	Wall thickness mm	Max. operating pressure at 23 °C bar	Colour
194212	259.24 N-V2	14	12	1	11	natural
194213	259.24 B-V2	14	12	1	11	blue
194214	259.24 G-V2	14	12	1	11	yellow
194215	259.24 R-V2	14	12	1	11	red
194216	259.24 S-V2	14	12	1	11	black
194217	259.24 GR-V2	14	12	1	11	green
194218	259.24 SI-V2	14	12	1	11	silver
194219	259.25 N-V2	16	12	2	21	natural
194220	259.25 S-V2	16	12	2	21	black

Polyamide hose - PA 12 HIPHL, roll of 100 m, packed in a paper box

Art. No.	Type No.	Tube O.D. mm	Tube I.D. mm	Wall thickness mm	Max. operating pressure at 23 °C bar	Colour
194146	259.09 N-100-V2	4	2	1	49	natural
194147	259.09 B-100-V2	4	2	1	49	blue
194148	259.09 S-100-V2	4	2	1	49	black
194166	259.11 N-100-V2	6	4	1	29	natural
194167	259.11 B-100-V2	6	4	1	29	blue
194168	259.11 S-100-V2	6	4	1	29	black
194176	259.12 N-100-V2	8	6	1	21	natural
194177	259.12 B-100-V2	8	6	1	21	blue
194178	259.12 S-100-V2	8	6	1	21	black
194189	259.13 N-100-V2	10	8	1	16	natural
194190	259.13 B-100-V2	10	8	1	16	blue
194191	259.13 S-100-V2	10	8	1	16	black
194199	259.14 N-100-V2	12	9	1.5	21	natural
194200	259.14 B-100-V2	12	9	1.5	21	blue
194201	259.14 S-100-V2	12	9	1.5	21	black

Polyamide DUO hose

MAX

DUO hoses made of polyamide PA 12.

PA 12 exhibits excellent impact and notched-impact resistance, even at temperatures as low as -60°C, and is resistant to corrosion and suitable for a wide temperature range.

It has a low water absorptive capacity and is therefore dimensionally stable if the ambient humidity varies. PA 12 resists greases, oil, fuels, hydraulic fluids, alkalis and salt solutions.

Sufficient UV resistance can only be guaranteed if the material is pigmented black!

PA DUO hoses are not suitable for use with push-in fittings. Suitable for vacuum up to 12 x 9 mm.

Temperature range	-60 to 100 °C
Colour	Blue / black

DUO hose, polyamid 12

Art. No.	Type No.	Tube O.D. mm	Tube I.D. mm	Max. operating pressure at 23 °C bar	Reel length m
113582	259.11-DUO	6	4	27	25
113583	259.12-DUO	8	6	19	25



259.11-DUO

NEW Hose cutter

Hose cutter (to O.D. 20 mm)

Art. No.	Type No.	Description
179288	SAS420	Hose cutter
198039	ESK420	Replacement blade, max. hose exterior Ø 20 mm



SAS420

Hose cutters

Hose cutter (to O.D. 14 mm)

Art. No.	Type No.	Description
113588	259.550	Hose cutter
113589	259.560	Replacement blade (1 piece)



259.550



Hose cutters and replacement blades

Robust, practical cutting pliers with replaceable blades. Suitable for all standard plastic hoses.



259.555

Hose cutter

Art. No.	Type No.	Max. tube O.D. mm
113584	259.555	17
113585	259.559	26

Replacement blades, pack of 5

Art. No.	Type No.	Description
113586	259.5555	For hose cutter max. tube O.D. 17 mm
113587	259.5599	For hose cutter max. tube O.D. 26 mm

PVC hose

transparent, non-braided

EASY

Food-grade PVC hose in conformity with EU Regulation No. 10/2011.

Unbeatably flexible hose for non-pressurised conveying of a wide variety of liquids such as fruit juices, mineral water, alcoholic beverages (up to 50% vol. at +40 °C), dairy products, diluted acids and alkaline solutions.

Advantages of the hose:

- Optimally visible media transport
- Extreme flexibility
- Good medium resistance

Temperature range -15 to 60 °C

PVC hose, transparent, non-braided

Art. No.	Type No.	Tube I.D. mm	Tube O.D. mm	Reel length m	Short-term pressure peaks at 20 °C bar
113789	191/1	2	4	100	13
125309	191/2-50	3	5	50	9.5
113791	191/3	4	6	100	7.5
113792	191/4-50	5	8	50	8.5
113793	191/5-50	6	8	50	5.5
113794	191/6-50	6	9	50	7.5
113795	191/7	6	10	50	9.5
113796	191/8	7	10	50	6.5
113797	191/9	8	11	50	6
113798	191/10	8	12	50	7.5
113799	191/11	9	12	50	5
113800	191/12	10	14	50	6
113801	191/13	12	16	50	5
113802	191/14	14	18	50	4.5
113803	191/15	13	19	50	7
113804	191/16	16	20	50	4
113805	191/17	18	22	50	3.5
113806	191/18	19	25	50	5
113807	191/19	20	24	50	3
113808	191/20	25	31	25	4
113810	191/21-50	25	33	50	5
113811	191/22	30	38	25	4
113812	191/23	32	40	25	4



191/12



Workshop hose

soft PVC

EASY

Highly flexible hose for compressed air applications in workshop areas (compressed air feed for pneumatic tools, equipping assembly stations, etc.).

Thanks to the even fabric reinforcement, this hose combines high pressure resistance, very good handling and high mechanical strength with excellent bond adhesion.

The high level of ozone resistance further enhances the hose's durability and reliability.



WSS11X6,3

Workshop hose soft PVC

Art. No.	Type No.	Tube I.D. mm	Tube O.D. mm	Min. bending radius mm
129224	WSS11X6,3	6.3	11	23
129225	WSS13X8	8	13	28
129226	WSS14,5X9	9	14.5	32
129227	WSS15,5X10	10	15.5	35
129228	WSS19X12,7	12.7	19	47
129229	WSS23X16	16	23	56
129230	WSS26,5X19	19	26.5	67
129231	WSS34X25	25	34	88

Soft PVC air hose kits

soft PVC workshop hose assembly

EASY

Highly flexible hose for compressed air applications in workshop areas. Assembled with brass stem and brass quick disconnect coupling DN 7.2 optional with pushbutton safety coupling DN 7.4 and galvanised steel stem.

Not suitable for direct attachment to pulsating tools.

We recommend using our vibration dampers, according to ISO 6150 § 7.1.

Operating temperature	-20 to 60 °C
Outer cover	Soft PVC, blue
Braid	High-strength polyester fabric
Inner tube	Soft PVC, black



DSB6-5

Soft PVC workshop hose kits with quick disconnect coupling and stem DN 7.2, brass

Art. No.	Type No.	Tube I.D. mm	Tube O.D. mm	Hose length m	Max. operating pressure at 20 °C bar
113841	DSB6-5	6.3	11	5	15
113842	DSB6-10	6.3	11	10	15
113843	DSB6-15	6.3	11	15	15
113844	DSB6-20	6.3	11	20	15
113845	DSB6-25	6.3	11	25	15
113846	DSB9-5	9	14.5	5	15
113847	DSB9-10	9	14.5	10	15
113848	DSB9-15	9	14.5	15	15
113849	DSB9-20	9	14.5	20	15
113850	DSB9-25	9	14.5	25	15

Soft PVC air hose kits

soft PVC workshop hose assembly

EASY

Soft PVC workshop hose kits with pushbutton safety coupling DN 7.4 and stem galvanised steel

Art. No.	Type No.	Tube I.D. mm	Tube O.D. mm	Hose length m	Max. operating pressure at 20 °C bar
113851	DSB6-5S	6.3	11	5	12
113852	DSB6-10S	6.3	11	10	12
113853	DSB6-20S	6.3	11	20	12
113854	DSB9-5S	9	14.5	5	12
113855	DSB9-10S	9	14.5	10	12
113856	DSB9-20S	9	14.5	20	12
132375	DSB13-10S	12.7	19	10	12
130734	DSB13-20S	12.7	19	20	12



DSB6-5S

→ You can find vibration dampers on page 851

Workshop hose

soft PVC, oil resistant

PLUS

Workshop hose to meet the most demanding requirements. Extremely flexible (even at low temperatures), good resistance to oil and chemicals, long service life and excellent resistance to mechanical stresses (deformation under pressure, bending cycles, pressure pulses).

Temperature range	-20 to 60 °C
Max. Operating pressure at 23 °C	16 bar
Outer cover	Soft PVC, black, oil-resistant
Braid	High-strength polyester fabric
Inner tube	Soft PVC, red, oil-resistant
Interlayer	Soft PVC, black
Reel length	50 m

Workshop hose soft PVC, oil resistant

Art. No.	Type No.	Tube I.D. mm	Tube O.D. mm	Min. bending radius mm
113857	193.06	6.3	11	18
113858	193.08	8	13	25
113859	193.09	9	14.5	25
113860	193.10	10	15.5	35
113861	193.13	12.7	19	50
113862	193.16	16	23	70
113863	193.19	19	26.5	70
113864	193.25	25	33.5	120



193.09



PVC braided hose

in reels à 50 m and 25 m

PLUS

Flexible, pressure-resistant and non-abrasive standard hose for a wide range of applications in industry, machinery and plant construction, commerce, manual trades and laboratories.

- Complies with EU Regulation No. 10/2011 regarding contact with food, simulants A, B, C
- Use of high-quality materials guarantees enhanced durability and UV protection

Temperature range -20 to 60 °C

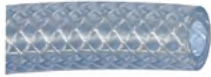

PGS10X4-50

PVC braided hose

Art. No.	Type No.	Tube I.D. mm	Tube O.D. mm	Max. operating pressure at 23 °C bar	Max. operating pressure liquids at 23 °C bar	Reel length m
129156	PGS10X4-50	4	10	22.5	30	50
129157	PGS12X6-50	6	12	15	20	50
129158	PGS14X8-50	8	14	15	20	50
129159	PGS15X9-50	9	15	15	20	50
129160	PGS16X10-50	10	16	15	20	50
129161	PGS18X12-50	12	18	15	20	50
129162	PGS19X13-50	13	19	15	20	50
129163	PGS23X16-50	16	23	15	20	50
129164	PGS26X19-50	19	26	15	20	50
129165	PGS33X25-50	25	33	12	16	50
129166	PGS12X6-25	6	12	15	20	25
129167	PGS14X8-25	8	14	15	20	25
129168	PGS15X9-25	9	15	15	20	25
129169	PGS16X10-25	10	16	15	20	25
129170	PGS18X12-25	12	18	15	20	25
129171	PGS19X13-25	13	19	15	20	25
129172	PGS23X16-25	16	23	15	20	25
129173	PGS26X19-25	19	26	15	20	25
129174	PGS33X25-25	25	33	12	16	25
129175	PGS42X32-25	32	42	5.25	7	25
129176	PGS48X38-25	38	48	4.5	6	25
129177	PGS60X50-25	50	60	3.75	5	25

PVC air hose kits

PVC braided hose assembly

PLUS

Flexible, pressure-resistant and non-abrasive standard hose, also resistant to ageing. Assembled with brass stem and brass quick disconnect coupling DN 7.2.

Not suitable for direct attachment to pulsating tools.

We recommend using our vibration dampers, according to ISO 6150 § 7.1.

Operating temperature	-20 to 60 °C
Max. Operating pressure at 23 °C	15 bar

PVC braided hose kit with quick disconnect coupling and stem DN 7.2, brass

Art. No.	Type No.	Tube I.D. mm	Tube O.D. mm	Hose length m
113747	DSK6-5	6	12	5
113748	DSK6-10	6	12	10
113749	DSK6-15	6	12	15
113750	DSK6-20	6	12	20
113751	DSK6-25	6	12	25
113752	DSK9-5	9	15	5
113753	DSK9-10	9	15	10
113754	DSK9-15	9	15	15
113755	DSK9-20	9	15	20
113756	DSK9-25	9	15	25
113757	DSK13-5	13	19	5
113758	DSK13-10	13	19	10



DSK6-5

→ You can find vibration dampers on page 851

PVC braided hose

fluorescent green

PLUS

Flexible, pressure-resistant and non-abrasive standard hose for a wide range of applications in industry, machinery and plant construction, commerce, manual trades and laboratories.

- Complies with EU Regulation No. 10/2011 regarding contact with food, simulants A, B, C
- Good chemical resistance when gaseous or liquid media are conveyed
- Use of high-quality materials guarantees enhanced durability and UV protection

Temperature range	-15 to 60 °C
Operating pressure	max. 20 bar air/gas, max. 15 bar liquids at 23 °C
Reel length	50 m

PVC braided hose, fluorescent green, 50 m reels

Art. No.	Type No.	Tube I.D. mm	Tube O.D. mm	Min. bending radius mm
113780	190/2-G	6	12	18
113781	190/4-G	9	15	33
113782	190/6-1-G	13	20	51



190/2-G



PVC safety air hose kits

PVC braided hose assembly - fluorescent green

PLUS

Flexible, pressure-resistant and non-abrasive standard hose. High safety standard through signal colours – fluorescent green. Assembled with pushbutton safety coupling DN 7.4. and stem galvanised steel.

Not suitable for direct attachment to pulsating tools.

We recommend using our vibration dampers, according to ISO 6150 § 7.1.

Operating temperature	-15 to 60 °C
Max. Operating pressure at 20 °C	12 bar



DSG6-5S

PVC braided hose kits - fluorescent green - with pushbutton safety coupling DN 7.4 and stem galvanised steel

Art. No.	Type No.	Tube I.D. mm	Tube O.D. mm	Hose length m
113783	DSG6-5S	6	12	5
113784	DSG6-10S	6	12	10
113785	DSG6-20S	6	12	20
113786	DSG9-5S	9	15	5
113787	DSG9-10S	9	15	10
113788	DSG9-20S	9	15	20

→ You can find vibration dampers on page 851

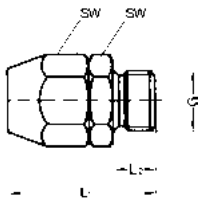

Male connectors

for PVC braided hose

PLUS



190/64

Male connector for PVC braided hose, aluminium

Art. No.	Type No.	Thread	for pvc hose	a/f mm	a/f 1 mm	L1 mm	L2 mm
113759	190/40	G 1/8	4x10	17	17	30.5	6.5
113760	190/41	G 1/8	6x12	17	19	32.5	6.5
113761	190/51	G 1/4	4x10	17	17	33.0	9.0
113762	190/52	G 1/4	6x12	17	19	35.0	9.0
113763	190/53	G 1/4	8x14	22	22	38.0	9.0
113764	190/54	G 1/4	9x15	22	24	38.5	9.0
113765	190/55	G 1/4	10x16	22	24	38.5	9.0
113766	190/61	G 3/8	4x10	19	17	33.0	9.0
113767	190/62	G 3/8	6x12	19	19	35.0	9.0
113768	190/63	G 3/8	8x14	22	22	38.0	9.0
113769	190/64	G 3/8	9x15	22	24	38.5	9.0
113770	190/65	G 3/8	10x16	22	24	38.5	9.0
113771	190/66	G 3/8	12x21	27	30	41.0	9.0
113772	190/67	G 3/8	13x20	27	30	41.0	9.0
113773	190/71	G 1/2	4x10	24	17	36.0	11.0
113774	190/72	G 1/2	6x12	24	19	37.5	11.0
113775	190/73	G 1/2	8x14	24	22	40.0	11.0
113776	190/74	G 1/2	9x15	24	24	40.5	11.0
113777	190/75	G 1/2	10x16	24	24	40.5	11.0
113778	190/76	G 1/2	12x21	27	30	43.0	11.0
113779	190/77	G 1/2	13x20	27	30	43.0	11.0

Special PVC pneumatic hose

in 50 m reels



Flexible, high-quality, PVC hose with a smooth inner layer and braiding made of special impregnated fabric, suitable for high pressures. Largely resistant to salt solutions, diluted acids and alkaline solutions, greases and mineral oils.

Temperature range	-10 to 60 °C
Material	PVC with integrated special fabric
Colour	Blue

Special PVC pneumatic hose

Art. No.	Type No.	Tube I.D. mm	Tube O.D. mm	Min. bending radius mm	Max. operating pressure at 20 °C bar
113813	170/1	4	6.2	50	40
113814	170/2	6	8.2	60	40
113815	170/3	8	10.2	65	35
113816	170/4	9	11.6	70	30
113817	170/5	10	12.5	80	28
113818	170/6	13	17.6	100	28



170/3

Male connectors

for special PVC pneumatic hose



Working pressure	-0.95 - 15 bar
Medium	Air
Operating temperature	-10 to 70 °C

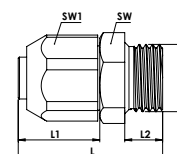

For special PVC pneumatic hose, aluminium/plastic

Art. No.	Type No.	Thread	for pvc hose	Material	a/f mm	a/f 1 mm	L mm	L1 mm	L2 mm
152978	11.0413/0-1	G 1/8	4x6.2	Aluminium / plastic	14	13	24.0	13.0	6.5
152979	11.0414/1-1	G 1/8	6x8.2	Aluminium / plastic	14	15	25.0	14.0	6.5
152981	11.0416/1-1	G 1/4	4x6.2	Aluminium / plastic	17	13	27.0	13.0	9.0
152982	11.0417/1-1	G 1/4	6x8.2	Aluminium / plastic	17	15	28.0	14.0	9.0
152983	11.0418/1-1	G 1/4	8x10.2	Aluminium / plastic	17	16	30.0	16.0	9.0
152984	11.0419/1-1	G 1/4	9x11.6	Aluminium / plastic	17	19	31.0	17.0	9.0
152985	11.0420/1-1	G 3/8	6x8.2	Aluminium / plastic	19	15	29.0	14.0	9.0
152986	11.0421/0-1	G 3/8	8x10.2	Aluminium / plastic	19	16	31.0	16.0	9.0
152992	11.0421/1-1	G 3/8	9x11.6	Aluminium / plastic	19	19	32.0	17.0	9.0
152987	11.0421/2-1	G 3/8	10x12.5	Aluminium	19	19	34.5	19.5	9.0
152988	11.0421/3-1	G 3/8	13x17.6	Aluminium	22	24	36.0	21.0	9.0
152989	11.0425/0-1	G 1/2	8x10.2	Aluminium / plastic	24	16	33.0	16.0	11.0
152990	11.0425/1-1	G 1/2	10x12.5	Aluminium	24	19	36.5	19.5	11.0
152991	11.0425/2-1	G 1/2	13x17.6	Aluminium	24	24	38.0	21.0	11.0



11.0421/2-1



Spiral hoses

polyamide, PA12

MAX

For safe and effective flow.

Thanks to their small coil diameter, they are compact, easy to handle and lightweight.

Operating temperature -40 to 80 °C



SP6PA



SP8500PA

Spiral hose, without fittings

Art. No.	Type No.	Hose size mm	Coil O.D. mm	No. of coils	Max. operating pressure at 23 °C bar	Service length max. m
158101	SP5PA	5x3	37	135	33	10.0
158102	SP6PA	6x4	71	127	27	18.0
158103	SP8PA	8x6	90	100	19	18.0
158104	SP10PA	10x8	118	76	15	18.0
158105	SP12PA	12x9	122	60	19	16.0

Spiral hose, with swivel adapter fitted at both ends and kink protector

Art. No.	Type No.	Thread	Hose size mm	Coil O.D. mm	No. of coils	Max. operating pressure at 23 °C bar	Service length max. m
158106	SP5250PA	R 1/8	5x3	37	37	33	2.5
158107	SP5500PA	R 1/8	5x3	37	73	33	5.0
158108	SP5750PA	R 1/8	5x3	37	110	33	7.5
158109	SP51000PA	R 1/8	5x3	37	147	33	10.0
158110	SP6250PA	R 1/4	6x4	71	15	27	2.5
158111	SP6500PA	R 1/4	6x4	71	31	27	5.0
158112	SP6750PA	R 1/4	6x4	71	47	27	7.5
158113	SP61000PA	R 1/4	6x4	71	62	27	10.0
158114	SP8250PA	R 1/4	8x6	90	13	19	2.5
158115	SP8500PA	R 1/4	8x6	90	25	19	5.0
158116	SP8750PA	R 1/4	8x6	90	37	19	7.5
158117	SP81000PA	R 1/4	8x6	90	49	19	10.0
158118	SP10250PA	R 1/4	10x8	118	9	15	2.5
158119	SP10500PA	R 1/4	10x8	118	19	15	5.0
158120	SP10750PA	R 1/4	10x8	118	28	15	7.5
158121	SP101000PA	R 1/4	10x8	118	38	15	10.0
158122	SP12250PA	R 3/8	12x9	122	9	19	2.5
158123	SP12500PA	R 3/8	12x9	122	17	19	5.0
158124	SP12750PA	R 3/8	12x9	122	26	19	7.5
158125	SP121000PA	R 3/8	12x9	122	34	19	10.0

Spiral hose and coupling kit

Spiral hose, polyamide, PA12

MAX

For safe and effective flow.

Thanks to their small coil diameter, they are compact, easy to handle and lightweight.

Not suitable for direct attachment to pulsating tools.

We recommend using our vibration dampers, according to ISO 6150 § 7.1.

Spiral hose and coupling kit with standard coupling bare brass, DN 7.2 and push-in plug, bare brass

Art. No.	Type No.	Hose size mm	Coil O.D. mm	No. of coils	Max. operating pressure at 23 °C bar	Operating temperature °C	Service length max. m
158126	SP8250PASK	8x6	90	13	19	-20 to 80	2.5
158127	SP8500PASK	8x6	90	25	19	-20 to 80	5.0
158128	SP8750PASK	8x6	90	37	19	-20 to 80	7.5
158129	SP81000PASK	8x6	90	49	19	-20 to 80	10.0
158130	SP10250PASK	10x8	118	9	15	-20 to 80	2.5
158131	SP10500PASK	10x8	118	19	15	-20 to 80	5.0
158132	SP10750PASK	10x8	118	28	15	-20 to 80	7.5
158133	SP101000PASK	10x8	118	38	15	-20 to 80	10.0
158134	SP12250PASK	12x9	122	9	19	-20 to 80	2.5
158135	SP12500PASK	12x9	122	17	19	-20 to 80	5.0
158136	SP12750PASK	12x9	122	26	19	-20 to 80	7.5
158137	SP121000PASK	12x9	122	34	19	-20 to 80	10.0



SP8500PASK

Spiral hose and coupling kit with pushbutton-type safety coupling DN 7.4 and push-in plug galvanised steel

Art. No.	Type No.	Hose size mm	Coil O.D. mm	No. of coils	Max. operating pressure at 23 °C bar	Operating temperature °C	Service length max. m
158138	SP8250PADSK	8x6	90	13	12	-20 to 70	2.5
158139	SP8500PADSK	8x6	90	25	12	-20 to 70	5.0
158140	SP8750PADSK	8x6	90	37	12	-20 to 70	7.5
158141	SP81000PADSK	8x6	90	49	12	-20 to 70	10.0
158142	SP10250PADSK	10x8	118	9	12	-20 to 70	2.5
158143	SP10500PADSK	10x8	118	19	12	-20 to 70	5.0
158144	SP10750PADSK	10x8	118	28	12	-20 to 70	7.5
158145	SP101000PADSK	10x8	118	38	12	-20 to 70	10.0
158146	SP12250PADSK	12x9	122	9	12	-20 to 70	2.5
158147	SP12500PADSK	12x9	122	17	12	-20 to 70	5.0
158148	SP12750PADSK	12x9	122	26	12	-20 to 70	7.5
158149	SP121000PADSK	12x9	122	34	12	-20 to 70	10.0



SP8500PADSK

→ You can find vibration dampers on page 851

Adapters with kink protector for spiral hoses

brass

Swivel adapter with kink protector for spiral hose made of nylon (PA)

Art. No.	Type No.	Thread	Hose size mm	a/f 1 mm	a/f 2 mm
159788	KSF1853DR	R 1/8	5x3	14	13
159789	KSF1464DR	R 1/4	6x4	14	14
159790	KSF1486DR	R 1/4	8x6	14	14
159791	KSF14108DR	R 1/4	10x8	16	16
159792	KSF38129DR	R 3/8	12x9	17	19



KSF1853DR



Adapters with kink protector for spiral hoses

brass

Rigid adapter with kink protector for calibrated hoses

Art. No.	Type No.	Thread	Hose size mm	a/f 1 mm	a/f 2 mm
159793	KSF1864ST	G 1/8	6x4	14	14
159794	KSF1886ST	G 1/8	8x6	14	14
159795	KSF1464ST	G 1/4	6x4	14	14
159796	KSF1486ST	G 1/4	8x6	14	14
159797	KSF14108ST	G 1/4	10x8	16	16
159798	KSF14129ST	G 1/4	12x9	17	19
159799	KSF3886ST	G 3/8	8x6	17	14
159800	KSF38108ST	G 3/8	10x8	17	16
159801	KSF38129ST	G 3/8	12x9	17	19

Spiral hoses

polyurethane

MAX

Standard type or with braided reinforcements for high pressures.

These exceptionally elastic polyurethane hoses boast a recoil force similar to that of conventional polyamide spiral hose, but with less tendency to loop and significantly better resistance to abrasion. There is consequently less danger of scratching coated or sensitive surfaces. The hose is extremely flexible and non-kinking.

Operating temperature -20 to 60 °C



SP8600PU

Spiral hose, with swivel adapter and kink protector

Art. No.	Type No.	Thread	Hose size mm	Coil O.D. mm	No. of coils	Max. operating pressure at 23 °C bar	Service length max. m
158156	SP8300PU	G 1/4	8x5	42	29	12	3.0
158157	SP8600PU	G 1/4	8x5	42	64	12	6.0
158158	SP8750PU	G 1/4	8x5	42	83	12	7.5
158159	SP81000PU	G 1/4	8x5	42	110	12	10.0
158160	SP10300PU	G 1/4	10x6.5	69	16	11	3.0
158161	SP10600PU	G 1/4	10x6.5	69	37	11	6.0
158162	SP10750PU	G 1/4	10x6.5	69	41	11	7.5
158163	SP101000PU	G 1/4	10x6.5	69	63	11	10.0
158164	SP12300PU	G 3/8	12x8	82	14	10	3.0
158165	SP12600PU	G 3/8	12x8	82	31	10	6.0
158166	SP12750PU	G 3/8	12x8	82	38	10	7.5
158167	SP121000PU	G 3/8	12x8	82	54	10	10.0



SP10600PUGV

Spiral hose, with swivel adapter and kink protector, braided

Art. No.	Type No.	Thread	Hose size mm	Coil O.D. mm	No. of coils	Max. operating pressure at 23 °C bar	Service length max. m
158168	SP10300PUGV	G 1/4	10x6.5	69	17	15	3.0
158169	SP10600PUGV	G 1/4	10x6.5	69	37	15	6.0
158170	SP10750PUGV	G 1/4	10x6.5	69	47	15	7.5
158171	SP12300PUGV	G 3/8	12x8	82	14	15	3.0
158172	SP12600PUGV	G 3/8	12x8	82	31	15	6.0
158173	SP12750PUGV	G 3/8	12x8	82	40	15	7.5

Spiral hose and coupling kit

Spiral hose polyurethane

MAX

These exceptionally elastic polyurethane hoses boast a recoil force similar to that of conventional polyamide spiral hose, but with less tendency to loop and significantly better resistance to abrasion. There is consequently less danger of scratching coated or sensitive surfaces. The hose is extremely flexible and non-kinking.

Not suitable for direct attachment to pulsating tools.

We recommend using our vibration dampers, according to ISO 6150 § 7.1.

Operating temperature -20 to 60 °C

Spiral hose and coupling kit with quick disconnect coupling bare brass, DN 7.2 and push-in plug, bare brass

Art. No.	Type No.	Hose size mm	Coil O.D. mm	No. of coils	Max. operating pressure at 23 °C bar	Service length max. m
158174	SP8300PUSK	8x5	42	29	12	3.0
158175	SP8600PUSK	8x5	42	64	12	6.0
158176	SP8750PUSK	8x5	42	83	12	7.5
158177	SP81000PUSK	8x5	42	110	12	10.0
158178	SP10300PUSK	10x6.5	69	16	11	3.0
158179	SP10600PUSK	10x6.5	69	37	11	6.0
158180	SP10750PUSK	10x6.5	69	41	11	7.5
158181	SP101000PUSK	10x6.5	69	63	11	10.0
158182	SP12300PUSK	12x8	82	14	10	3.0
158183	SP12600PUSK	12x8	82	31	10	6.0
158184	SP12750PUSK	12x8	82	38	10	7.5
158185	SP121000PUSK	12x8	82	54	10	10.0



SP8600PUSK

Spiral hose and coupling kit with quick disconnect coupling galvanised steel, DN 7.8 and push-in plug, galvanised steel

Art. No.	Type No.	Hose size mm	Coil O.D. mm	No. of coils	Max. operating pressure at 23 °C bar	Service length max. m
158198	SP8300PUSSK	8x5	42	29	12	3.0
158199	SP8600PUSSK	8x5	42	64	12	6.0
158200	SP8750PUSSK	8x5	42	83	12	7.5
158201	SP81000PUSSK	8x5	42	110	12	10.0
158202	SP10300PUSSK	10x6.5	69	16	11	3.0
158203	SP10600PUSSK	10x6.5	69	37	11	6.0
158204	SP10750PUSSK	10x6.5	69	41	11	7.5
158205	SP101000PUSSK	10x6.5	69	63	11	10.0
158206	SP12300PUSSK	12x8	82	14	10	3.0
158207	SP12600PUSSK	12x8	82	31	10	6.0
158208	SP12750PUSSK	12x8	82	38	10	7.5
158209	SP121000PUSSK	12x8	82	54	10	10.0



SP8600PUSSK

Spiral hose and coupling kit with pushbutton-type safety coupling DN 7.4 and push-in plug, galvanised steel

Art. No.	Type No.	Hose size mm	Coil O.D. mm	No. of coils	Max. operating pressure at 23 °C bar	Service length max. m
158186	SP8300PUDSK	8x5	42	29	12	3.0
158187	SP8600PUDSK	8x5	42	64	12	6.0
158188	SP8750PUDSK	8x5	42	83	12	7.5
158189	SP81000PUDSK	8x5	42	110	12	10.0
158190	SP10300PUDSK	10x6.5	69	16	11	3.0
158191	SP10600PUDSK	10x6.5	69	37	11	6.0



SP8600PUDSK



Spiral hose and coupling kit

Spiral hose polyurethane

MAX



SP8600PUDSK

Spiral hose and coupling kit with pushbutton-type safety coupling DN 7.4 and push-in plug, galvanised steel

Art. No.	Type No.	Hose size mm	Coil O.D. mm	No. of coils	Max. operating pressure at 23 °C bar	Service length max. m
158192	SP10750PUDSK	10x6.5	69	41	11	7.5
158193	SP101000PUDSK	10x6.5	69	63	11	10.0
158194	SP12300PUDSK	12x8	82	14	10	3.0
158195	SP12600PUDSK	12x8	82	31	10	6.0
158196	SP12750PUDSK	12x8	82	38	10	7.5
158197	SP121000PUDSK	12x8	82	54	10	10.0

→ You can find vibration dampers on page 851

Swivel adapters

for spiral hoses



SP 221

Swivel adapter

Art. No.	Type No.	Thread	a/f mm	Hose size mm
113473	SP 220	G 1/4	17	8x5
113474	SP 221	G 1/4	17	10x6.5
113475	SP 222	G 3/8	19	12x8

Spiral hose and coupling kits

anti-spark type

MAX

Completely installed with safety coupling and nipple NW 7.6 for demanding industrial compressed air applications.

High-quality safety coupling made of steel, able to operate with one hand, for high flow values. For demanding applications with high mechanical wear. The hose has a spark guard on the outer layer and resists flying sparks and scorching. Therefore it is optimally suited for use by compressed air tools in the area of welding work.

Max. operating pressure	10 bar
Material	Polyurethane (Spiral hose)

Spiral hose and coupling kit with safety coupling, anti-spark type

Art. No.	Type No.	Hose size mm	Coil diameter mm	Service length max. m
136520	SP 245-204	10x6.5	52	4.0
136521	SP 245-206	10x6.5	52	6.0
136522	SP 245-218	12x8	65	8.0



SP 245-206

Spiral hose and blow gun kits

MAX

Each hose kit, comprising a spiral hose polyamide, die-cast aluminium nickel-plated blow gun, integrated DN 7.2 quick disconnect coupling and nipple DN 7.2, is ready for immediate use.

Max. operating pressure	10 bar
Medium temperature	-10 to 50 °C
Ambient temperature	-10 to 50 °C

Spiral hose and blow gun kits, polyamide

Art. No.	Type No.	Hose size mm	Service length max. m
159859	SPPS8250PA	8x6	2.5
159860	SPPS8500PA	8x6	5.0



SPPS8250PA

Spiral hose and blow gun kits »Typhoon«

MAX

Instantly operational hose set, consisting of a polyurethane spiral hose, a high-performance blow gun »Typhoon« type, a permanently attached push button safety coupling NW 7.4 and galvanised steel plug nipple.

Max. operating pressure	10 bar
Operating temperature	0 to 50 °C

Spiral hose and blow gun kits »Typhoon«, polyurethane

Art. No.	Type No.	Hose size mm	Service length max. m
159861	SPPST10300PU	10x6.5	3.0
159862	SPPST10600PU	10x6.5	6.0



SPPST10300PU



PUR hose and coupling kits

MAX

Spiral or straight polyurethane hose, completely assembled with DN 7.6 safety coupling and steel plugs.

Coupling

Safety coupling made of steel / nickel-plated brass for high flow rates, specially designed for all applications susceptible to severe mechanical wear.

Strong, impact and vibration-resistant design for demanding environments.

Polyurethane hose

Extremely flexible spiral hose with excellent kink resistance and insensitive to dirt.

Combines high tear, tensile and impact strength with a long service life and optimal ageing qualities.

This hose is additionally characterised by outstanding resistance to abrasion and resistance to UV.

Not suitable for direct attachment to pulsating tools.

We recommend using our vibration dampers, according to ISO 6150 § 7.1.

Medium temperature	-20 to 60 °C
Ambient temperature	-20 to 60 °C



SP 246-104

Spiral hose and coupling kit, with safety couplings DN 7.6

Art. No.	Type No.	Coil diameter mm	Hose size mm	Max. operating pressure bar	Service length max. m
113487	SP 246-102	52	10x6.5	10	2.0
113488	SP 246-104	52	10x6.5	10	4.0
113489	SP 246-106	52	10x6.5	10	6.0
113490	SP 246-108	52	10x6.5	10	8.0
113491	SP 246-122	65	12x8	10	2.0
113492	SP 246-124	65	12x8	10	4.0
113493	SP 246-126	65	12x8	10	6.0
113494	SP 246-128	65	12x8	10	8.0



SKS 248.1210

PUR hose and coupling kit, with straight hose and DN 7.6 safety coupling

Art. No.	Type No.	Hose size mm	Max. operating pressure bar	Service length max. m
113499	SKS 248.1210	12x8	16	10.0
113500	SKS 248.1215	12x8	16	15.0
113501	SKS 248.1610	16x11	16	10.0
113502	SKS 248.1615	16x11	16	15.0

→ For product description see page 519

→ You can find vibration dampers on page 851

Compressed air and water hose

in 50 m reels

MAX

Robust yet flexible hose type for high pressure loads.

The hose cover resists the temporary influence of oil and is non-abrasive and weatherproof.

Inner tube	NR/SBR, black
Reinforcements	Textile
Outer cover	NR/EPDM black
Max. operating pressure	20 bar
Temperature range	-20 to 60 °C
Colour	Black

Compressed air and water hose

Art. No.	Type No.	Tube I.D. mm	Tube O.D. mm	Min. bending radius mm
114586	180/6	6	13	48
114587	180/9	9	17	72
114588	180/4	13	23	104



180/4

Industrial water hoses

type »Inducord®«, in 40 m reels



Industrial water hose for use with process water, liquid manure or weak acids and alkaline solutions.

Max. operating pressure	10 bar
Burst pressure	30 bar
Temperature range	-30 to 80 °C
Inner tube	SBR, black, smooth
Outer cover	SBR, black, patterned material

Industrial water hose

Art. No.	Type No.	Tube I.D. mm	Tube O.D. mm	Min. bending radius mm
113885	3040.022	22	30	176
113886	3040.025	25	35	200
113887	3040.028	28	38	224
113888	3040.032	32	43	256
113889	3040.035	35	46	280
113890	3040.038	38	50	304
113891	3040.040	40	52	320
113892	3040.042	42	54	336
113893	3040.045	45	57	360
113894	3040.048	48	60	384
113895	3040.050	50	64	400
113896	3040.060	60	73	480



3040.038

→ IMPORTANT:

These hoses are shipped from our distribution centre in the Netherlands using a forwarding agent.

→ For wide-band hose clamps see page 885



Water hose



Multilayer soft PVC water hose with knitted polyester reinforcement. This multilayer hose with knitted fabric reinforcement and „Non Torsion Technology“ is extremely flexible and easy to use.

Temperature range	-15 to 60 °C
Applications	Agricultural industry, construction industry, horticulture and landscaping, agriculture



WS17X13-50

Water hose

Art. No.	Type No.	Tube O.D. mm	Max. operating pressure at 23 °C bar	Min. bending radius mm	Reel length m
205634	WS17X13-25	17	8	140	25
205635	WS17X13-50	17	8	140	50
205636	WS24X19-25	23.8	6	200	25
205637	WS24X19-50	23.8	6	200	50
205638	WS31X25-25	31	6	255	25
205639	WS31X25-50	31	6	255	50

→ For compatible GEKA couplings, see page 558-559

Drinking water hose

in 50 m reels



Multi-layer hose suitable for drinking water, meets the KTW specifications of the German Federal Environment Agency (Cat. " A ") and DVGW Code of Practice W270. Ideal for conveying drinking water, (alcoholic) beverages, liquid foods, vegetable oils and dairy products.

Temperature range	-15 to 50 °C
Max. Operating pressure at 23 °C	20 bar
Outer cover	Soft PE
Braid	High-strength polyester fabric
Inner tube	Soft PE



TWS.19

Drinking water hose

Art. No.	Type No.	Tube I.D. mm	Tube O.D. mm	Min. bending radius mm
113953	TWS.10	10	15	35
113954	TWS.13	13	20	70
113955	TWS.19	19	27	108
113956	TWS.25	25	34.5	148

→ For compatible GEKA couplings for drinking water, see page 560

NEW Salt and hot water hose

in 40 m reels



Robust hose type for salt and hot water.
The hose cover resistant to ozone, aging, UV and weather.

Inner tube	EPDM, black
Reinforcements	Fabric inserts
Outer cover	EPDM, black
Max. operating pressure	20 bar
Temperature range	-40 to 100 °C
Colour	black

Salt and hot water hose				
Art. No.	Type No.	Tube I.D. mm	Tube O.D. mm	Min. bending radius mm
118568	HWS20X13	13	20	80
118569	HWS27X19	19	27	120
118570	HWS34X25	25	34	150



HWS20X13

PTFE hoses

in 50 m reels



PTFE hose combining excellent anti-friction properties with a high temperature resistance up to 260 °C.
Resistant to the majority of aggressive media. Extremely low friction coefficient.

Temperature range	-60 to 260 °C
Colour	Natural

PTFE hose					
Art. No.	Type No.	Tube I.D. mm	Tube O.D. mm	Min. bending radius mm	Max. operating pressure at 20 °C bar
113869	259.30 N	2	4	5	42
113870	259.31 N	3	5	10	32
113871	259.32 N	4	6	15	25
113872	259.33 N	6	8	30	18
113873	259.34 N	8	10	70	14
113874	259.35 N	9	12	50	15



259.32 N



Electrically conductive hose

»FreStat« type in 25 m reels



Ether based polyurethane hose. The hose is conductive (insulating).

Applications: Electrical systems, medical equipment, robotics, clean rooms in the semiconductor industry, packaging machines, powder coating machines.

Temperature range	-40 to 70 °C
Static discharge	Acc. to EIS Std. 541
Specific volume resistance	9.9×10^9 Ohm-cm
Surface resistance	9.9×10^9 Ohm-cm



189.02

Electrically conductive hose

Art. No.	Type No.	Tube I.D. mm	Tube O.D. mm	Min. bending radius mm	Working pressure at 25 °C bar	Working pressure at 65 °C bar
113875	189.01	2.4	4	9.5	7.24	3.45
113876	189.02	4	6	12.7	6.21	3.1
113877	189.03	5	8	19	6.89	3.45
113878	189.04	8	12	28.6	6.21	3.1

Anti-spark PU hose

»Sparklin« type in 25 m reels



Blue polyurethane hose with an outer sheath made of black synthetic resin material. This sheath protects the inner PU tube from welding sparks.

The sheath is not attached to the inner tube and can therefore be easily removed to enable conventional fittings to be installed.

- Protects against welding sparks
- Extremely flexible and non-kinking
- Resistant to a large number of chemicals, oils, greases, acids, bases, heat, ageing, UV light

Temperature range	-40 to 70 °C
Working pressure	5 - 12 bar
Colour	Black



189.52

Anti-spark PU hose

Art. No.	Type No.	Tube I.D. mm	Tube O.D. mm	Min. bending radius mm
113879	189.50	4	6	12.7
113880	189.51	5	8	19
113881	189.52	8	12	28.6

Braided PUR hose

in 50 m reels



Braided polyurethane hose, compatible with our safety couplings with »stream line« connection.

Temperature range -30 to 60 °C

Braided PUR hose

Art. No.	Type No.	Tube I.D. mm	Tube O.D. mm	Min. bending radius mm	Max. operating pressure at 20 °C bar
113865	PSL-065	6.5	10	26.6	16
113866	PSL-080	8	12	35.2	16
113867	PSL-095	9.5	13.5	48	16
113868	PSL-110	11	16	60	12



PSL-110

→ For safety couplings with »stream line« connection see page 519

Oxyacetylene hose



Proven, flexible design acc. to DIN EN ISO 3821:2010 with non-abrasive cover.

Inner tube EPDM/SBR, black, flat
Reinforcements Textile braided or spiral
Outer cover EPDM/SBR ribbed
Max. operating pressure 20 bar
Temperature range -20 to 60 °C

Oxyacetylene hose

Art. No.	Type No.	Tube I.D. mm	Tube O.D. mm	Min. bending radius mm	Colour	Gas type
205657	180/2-R-50	6	13	80	red	Acetylen
205658	180/2-B-50	6	13	80	blue	Oxygen
205659	180/3-R-50	9	16	90	red	Acetylen



180/2-R-50



Suction and discharge hoses

lightweight type



Transparent PVC spiral hose with green, impact-resistant, hard PVC spiral and smooth inner layer (prevents sediment).

Applications: Construction industry, agriculture, engineering, gardening and landscaping

Temperature range -15 to 60 °C

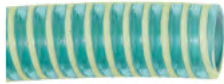

SDL-020

Suction and discharge hose, lightweight type

Art. No.	Type No.	Tube I.D. mm	Wall thickness mm	Max. operating pressure at 23 °C bar	Min. bending radius mm	Reel length m
113903	SDL-020	20	2.3	6	80	50
113904	SDL-025	25	2.3	5	105	50
113905	SDL-032	32	2.4	5	135	50
113906	SDL-038	38	2.8	5	160	50
113907	SDL-040	40	2.9	5	180	25
113908	SDL-050	50	3.2	4	230	50

Suction and discharge hoses

heavy-duty type



Transparent plastic hose with spiral steel wire embedded in the wall.

Suitable for process water, sludge and liquid manure under extreme conditions. Extremely flexible and non-toxic. Acc. to 2007/19/EC.

Vacuum 0.9 bar
Temperature range -15 to 60 °C



4480.051-50

Suction and discharge hose, PVC

Art. No.	Type No.	Tube I.D. mm	Tube O.D. mm	Min. bending radius mm	Max. operating pressure at 20 °C bar	Reel length m
113909	4480.010	10	16	30	10	30
113910	4480.012	12	18	36	9	30
113911	4480.014-50	14	20	42	9	50
113912	4480.016-50	16	22	48	9	50
113913	4480.018-50	18	24	54	8	50
113914	4480.020-50	20	27	60	8	50
113915	4480.025-50	25	33	75	8	50
113916	4480.032-50	32	40	96	8	50
113917	4480.038-50	38	47	114	7	50
113918	4480.040-50	40	49	120	7	50
113919	4480.045-50	45	54	135	6	50
113920	4480.051-50	51	61	153	5	50
113921	4480.060	60	71	180	5	30
113922	4480.063	63	75	189	5	30
113923	4480.076	76	88	228	4	30
113924	4480.080	80	93	240	4	30
113925	4480.090	90	103	270	4	20
113926	4480.102	102	116	306	3	20

→ IMPORTANT:

Hose sizes 50 x 40 mm and larger are shipped from our distribution centre in the Netherlands using a forwarding agent.

→ For wide-band hose clamps see page 885

Suction and discharge hoses

Type »Heduflex®«



Rubber hose with spiral steel wire embedded in the wall

Suitable for process water, liquid manure or weak acids and alkaline solutions
Extremely flexible and non-toxic.

Vacuum	0.8 bar
Max. operating pressure	10 bar
Burst pressure	30 bar
Temperature range	-30 to 80 °C
Inner tube	SBR, black, smooth
Outer cover	SBR, black, patterned material

Suction and discharge hoses

Art. No.	Type No.	Tube I.D. mm	Tube O.D. mm	Min. bending radius mm	Reel length m
113927	3640.019	19	30	95	40
113928	3640.025	25	35	125	40
113929	3640.032	32	43	160	40
113930	3640.038	38	50	190	40
113931	3640.040	40	52	200	40
113932	3640.051	51	64	255	40
113933	3640.060	60	73	300	40



3640.032

→ IMPORTANT:

These hoses are shipped from our distribution centre in the Netherlands using a forwarding agent.

→ For wide-band hose clamps see page 885



Dekabon tubes



Dekabon tubing, which combines the advantages of metal and plastic tubing. Bending the very light tubing is possible without special tools. Good resistance against corrosion and various chemicals. The interior tube remains dry due to a film/aluminium barrier and can be laid in the ground without additional protection. Connection is possible with push-in connectors (additional self testing) and cutting ring fittings (amplification sleeve recommended).

Areas of application:

- pneumatic measurement and control lines in very wet or moist environments
- air and gas sampling
- aggressive environments (corrosion)
- The interior surface is best suited for air

Temperature range	-40 to 80 °C
Outer cover	Polyethylene
Inner tube	Aluminium



DKB-0805-25

Dekabon tube

Art. No.	Type No.	Tube I.D. mm	Tube O.D. mm	Max. operating pressure at 23 °C bar	Min. bending radius mm	Reel length m
141353	DKB-0604-25	4	6	28	19	25
141357	DKB-0805-25	5.3	8	28	25	25
141362	DKB-1006-25	6.2	10	28	32	25
141366	DKB-1208-25	8.13	12	24	40	25
141370	DKB-1410-25	9.75	14	24	50	25
141373	DKB-1511-25	10.75	15	20	50	25

Spiral wrap

natural polyethylene



08-1209

Spiral wrap 12x9 mm

Art. No.	Type No.	No. of wrappable hoses
113943	08-1209	20 x 3/5, 15 x 4/6, 8 x 6/8, 5 x 8/10

Multiple hose holders

blue polyethylene

Colour	blue
--------	------



KL 101

Multiple hose holder

Art. No.	Type No.	For tube O.D. mm
144445	KL 100	4-5
113944	KL 101	6
113945	KL 102	8
113946	KL 103	10

Vibration dampers

When using pulsating tools it is recommended to observe the standard ISO 6150, § 7.1. It recommends installing a minimum 300 mm long, flexible hose between the pulsating tool and the quick-connect coupling.

The oscillating forces are taken by the hose piece and thus increase the service life of the quick-connect coupling. No warranty can be made for couplings mounted directly on pulsating tools.

Max. operating pressure	15 bar
Temperature range	-20 to 60 °C

Vibration damper with 300 mm PVC workshop hose				
Art. No.	Type No.	Connection	DN	
142182	VD-300-7,2-1/4	G 1/4 ET	7.2 - 7.8	
142894	VD-300-8-1/2	G 3/8 ET	8	
142186	VD-300-10-1/2	G 1/2 ET	10	
142895	VD-300-11-1/2	G 1/2 ET	11	
142187	VD-300-12-1/2	G 1/2 ET	12	
142190	VD-300-19-1	G 1 ET	19	



VD-300-7,2-1/4

Hose security cable

For the security of two hoses connected, protecting against the "whip" when to hoses unintentional disconnect.

Hose security cable, galvanised steel		
Art. No.	Type No.	For tube O.D. mm
143282	SSK-1335	13 - 35
143283	SSK-3875	38 - 75



SSK-1335



SSK-3875



Hose rupture valves

»HoseGuard« type

Efficient protection for ruptured hoses or pipes in pneumatic systems. Preset to permit normal air consumption by pneumatic tools.

Hose Guard detects a rupture in a hose or pipe and interrupts the supply of compressed air in a fraction of a second apart from a minimal residual flow. Unaffected parts of the compressed air system remain fully pressurised, so that the damaged hose or segment can be replaced without difficulty. Once the ruptured hose or pipe has been repaired, the replaced segment gradually fills to its working pressure level. As soon as this occurs, Hose Guard opens the line again for normal operation.

Installation: Upstream of a coupling (connector between hard piping and junction box/coupling) and downstream of a service unit.

»Hose Guard«

- Protects personnel, machinery and plant against damage if a pneumatic system or hose ruptures
- Complies with the EU standard DIN EN ISO 4414: 2010, 2011-04 - § 5.4.5.11
- Is reliable and tamper-proof
- Can be installed in any pneumatic system

Housing	Aluminium
Sealant	NBR
Max. input pressure	18 bar



2222.12



2223.38

Hose rupture valve

Art. No.	Type No.	Thread	Piston	Operating temperature °C	a/f mm	Length mm
139072	2222.14	G 1/4 ET/IT	Polyacetate	-20 to 80	22	57.0
139073	2222.38	G 3/8 ET/IT	Polyacetate	-20 to 80	27	70.0
139074	2222.12	G 1/2 ET/IT	Polyacetate	-20 to 80	30	80.0
139075	2223.14	G 1/4 IT/IT	Polyacetate	-20 to 80	22	48.0
139076	2223.38	G 3/8 IT/IT	Polyacetate	-20 to 80	27	59.0
139077	2223.12	G 1/2 IT/IT	Polyacetate	-20 to 80	30	65.0
139078	2223.34	G 3/4 IT/IT	Aluminium	-20 to 120	30	76.0
139079	2222.10	G 1 IT/IT	Aluminium	-20 to 120	41	100.0
139080	2222.20	G 2 IT/IT	Aluminium	-20 to 120	70	130.0

→ ATTENTION

For suitable hoses, please check the respective data sheet.

Hose reel

Standard type for compressed air and water

EASY

Hose reel with automatic rewind and spring assembly. Robust hose locking mechanism, impact resistant plastic casing. Swivel wall mount made made from coated steel. Easy mounting on the wall or ceiling.

Hose material	Polyurethane (PUR)
Max. operating temperature	40 °C
Thread, input	G 1/4 female
Thread, output	G 1/4 male
Swivel angle	150 °
Applications	for compressed air and water

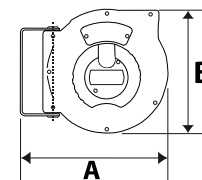

Hose reel, standard type

Art. No.	Type No.	Hose size mm	Max. operating pressure bar	Hose length m	A mm	B mm
113978	275.09	8x12	10	9	325.0	275.0
113979	276.12	8x12	15	12	355.0	315.0

Hose reels

compact type

PLUS

A compact, lightweight and affordable hose reel for universal air applications whenever space is restricted.

Housing	Rugged, impact-resistant polypropylene
Hose material	Polyurethane
Max. operating pressure	10 bar
Operating temperature	-10 to 40 °C
Swivel angle	180 °
Connection	G 1/4
Thread, input	Hose stem 8 mm

Hose reel, compact type

Art. No.	Type No.	Hose size mm	Hose length m	A mm	B mm
113974	259/4010	8x12	7	340.0	245.0

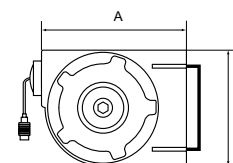

7

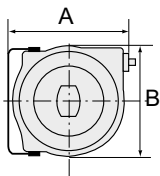

Hose reels

for compressed air and water – lightweight type

PLUS

High-quality, impact-resistant polypropylene housing. An automatic latching mechanism allows the hose to be engaged at any length. Enclosed spring. Precise locking device for continuous feeding or stop function. Reel guide prevents excessive wear on the hose. Hose connection R 3/8 is supplied with adapter R 1/4.



SAR8M.15B.R14R38



SAR15M.15B.R14

Hose material	PVC
Operating temperature	-15 to 60 °C
Max. operating pressure	15 bar
Thread, input	R 1/4-R 3/8
Swivel angle	180 °

Hose reel for compressed air and water, lightweight type

Art. No.	Type No.	Hose size mm	Hose length m	A mm	B mm
206189	SAR8M.15B.R14R38	8x12	8	340.0	263.0
206190	SAR15M.15B.R14	6.5x10	15	340.0	263.0

Hose reels

for compressed air

MAX

Easy mounting on the wall or ceiling. Closed, rugged, impact-resistant housing made of POM and lightweight, hard-wearing, oil-resistant polyurethane hose. Incl. 2 m feeder hose

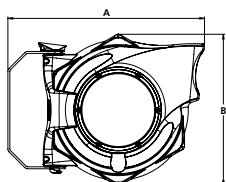

Hose material	Braided polyurethane
Operating temperature	-20 to 60 °C
Swivel angle	180 °



259/5000-1

Hose reel for compressed air

Art. No.	Type No.	Hose size mm	Max. operating pressure bar	Hose length m	A mm	B mm
152313	259/5120-1	9.5x13.5	16	14	490.0	409.0
152310	259/5100-1	8x12	16	17	490.0	409.0
152314	259/5000-1	8x12	16	10	406.0	313.0
152315	259/4900-1	8x12	16	7	406.0	313.0

Hose reels

for compressed air

MAX

Specially designed to ensure a high flow capacity.

Easy mounting on the wall or ceiling. Closed, rugged, impact-resistant housing made of POM, supply/outlet R 1/4 male thread and lightweight, hard-wearing, oil-resistant polyurethane hose. Incl. 1.5 m feeder hose.

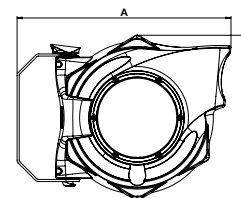

Hose material	Braided polyurethane
Max. operating pressure	12 bar
Operating temperature	-20 to 60 °C
Swivel angle	180 °

Hose reel for compressed air, high flow capacity

Art. No.	Type No.	Hose size mm	Hose length m	A mm	B mm
159987	259/4000-1	11x16	10	490.0	409.0



259/4000-1

Hose reel

for compressed air, anti-spark

MAX

For simple mounting on the wall or ceiling.

Shock resistant, solid and closed housing made of POM, disposal/outflow R 3/8 AG and with light, heavy duty, oil resistant and spark erosion protected polyurethane hose.

The hose is resistant to flying sparks and scorching, which can occur in the welding environment or with the use of cutting tools.

Incl. 1.5 m supply hose.

Hose material	braided, spark erosion protected polyurethane
Max. operating pressure	12 bar
Operating temperature	-20 to 60 °C
Swivel angle	180 °

Hose reel for compressed air, anti-spark

Art. No.	Type No.	Hose size mm	Hose length m	A mm	B mm
159988	259/5130-1	9.5x13.5	14	490.0	409.0



259/5130-1



7

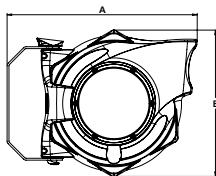

Hose reel

for water



Easy mounting on the wall or ceiling. Closed, rugged, impact-resistant housing made of POM, supply/outlet R 3/8 male thread and lightweight, hard-wearing, braided PVC hose. Incl. 2 m feeder hose.

Hose material	Braided PVC
Max. operating pressure	9 bar
Operating temperature	5 to 60 °C
Swivel angle	180 °



259/4400-1

Hose reel for water

Art. No.	Type No.	Hose size mm	Hose length m	A mm	B mm
152587	259/4400-1	9.5x13.5	14	490.0	409.0

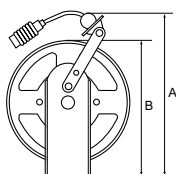

Hose reels

for compressed air and water - heavy-duty type



Heavy-duty steel design for industrial applications. Blue, powder-coated housing. An automatic latching mechanism allows the hose to be engaged at any length. Enclosed spring. Precise locking device for continuous feeding or latching mechanism. Reel guide prevents excessive wear on the hose.

Hose material	Polyurethane
Max. operating pressure	10 bar
Operating temperature	-10 to 40 °C
Thread, input	Hose stem 8 mm
Mounting options	Wall, floor or ceiling



259/6020

Hose reel for compressed air and water, heavy-duty type

Art. No.	Type No.	Hose size mm	Hose length m	A mm	B mm
113970	259/6020	6.5x10	10	420.0	353.0
113971	259/6021	6.5x10	20	420.0	353.0
113972	259/6022	8x12	15	420.0	353.0
113973	259/6023	11x16	15	420.0	353.0

Hose reel

welding type



Heavy-duty steel design for industrial applications. Blue, powder-coated housing. Special reel guide prevents excessive wear on the hose. An automatic latching mechanism allows the hose to be engaged at any length. Enclosed spring. Precise locking device for continuous feeding or latching mechanism. Welding hose for oxygen and acetylene, red and blue, made from synthetic rubber.

Inlet: Oxygen G 1/4 male, right-hand thread with 60° inside cone.
Acetylene G 3/8 male, left-hand thread with 60° inside cone.

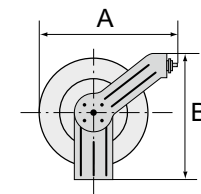

Max. operating pressure	10 bar
Mounting options	Wall, floor or ceiling

Hose reel, welding type						
Art. No.	Type No.	Hose size mm	Hose length m	Height mm	Diameter mm	
113967	259/7501	Oxygen 6x16.5 - Acetylene 10x17	15	360.0	320	



259/7501

Compressed air hose reels



Including 20 m high-quality, PVC braided hose, one-hand couplings (DN 7.2) and all connectors

Compressed air hose reels			
Art. No.	Type No.	Hose size mm	
113975	190/226	6x12	
113976	190/229	9x15	



190/226

Hose reels

for mobile applications



Specially designed for mobile applications. This 50 m long polyurethane hose is mounted in a portable four-wheel cart made from blue anodised steel. An automatic latching mechanism allows the hose to be engaged at any length. Enclosed spring. Precise locking device for continuous feeding or latching mechanism. Reel guide prevents excessive wear on the hose.

Hose material	Polyurethane
Max. operating pressure	10 bar
Operating temperature	-10 to 40 °C
Thread, input	Hose stem 8 mm
Connecting thread	Coupling G 3/8

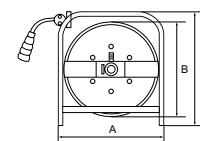

Hose reel, for mobile applications						
Art. No.	Type No.	Hose size mm	Hose length m	A mm	B mm	C mm
113977	259/4050	8x12	50	452.0	400.0	460.0



259/4050



7

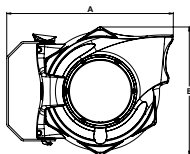

Electrical cable reels

easy mounting on the wall or ceiling



Closed, rugged, impact-resistant housing made of POM. Includes a thermal circuit breaker. In case of overloading, a thermal overload protective circuit cuts off the electrical power supply automatically

Input	Rubber H07RN-F 3 x 1.5 mm ²
Operating voltage	max. 240 V
Current max.	10 Ampère
Connection	SchuKo plug
Power input	Max. 1600 W (fully wound), max. 2400 W (fully unwound)
Swivel angle	180 °



EKR240V10M

Cable reel

Art. No.	Type No.	Cable length m	A mm	B mm
202193	EKR240V10M	10	406.0	313.0
174140	259/5150-1	17	490.0	409.0

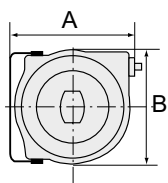

Electrical cable reel

easy mounting on the wall or ceiling



High-quality, polypropylene (PP) housing. Includes a thermal circuit breaker. In case of overloading, a thermal overload protective circuit cuts off the electrical power supply automatically.

Cable type	HO5VV-F
Current max.	10 Ampère
Connection	SchuKo plug
Power input	Max. 1000 W (fully wound), max. 2000 W (fully unwound)
Swivel angle	180 °



259/7100

Cable reel

Art. No.	Type No.	Cable length m	Voltage	A mm	B mm
113982	259/7100	15	230 V, 50 Hz	335.0	290.0

Hose holders

aluminium

Easy mounting on the wall with variable hole pattern (7 drilled holes).
Suitable for holding hoses, cables or ropes.
Unpainted.
Countersunk holes guarantee a smooth surface in the mounting area.

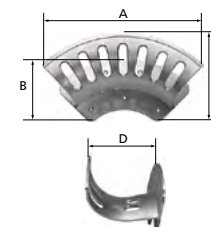

Material	Aluminium, unpainted
----------	----------------------

Hose holders							
Art. No.	Type No.	Size	A mm	B mm	C mm	D mm	Max. hose length
113983	SH 01	Small	187.0	86.0	82.0	70.0	For Ø 6, 35 - 40 m
113984	SH 02	Medium	254.0	113.0	105.0	106.0	For Ø 9, 45 - 50 m
113985	SH 03	Large	348.0	151.0	157.0	137.0	For Ø 13, 45 - 50 m
113986	SH 04	Maxi	389.0	180.0	174.0	188.0	For Ø 26, 35 - 40 m



SH 02

→ In combination with the rounded holder design, the fact that a small hose holder can be placed inside a large one, or a medium hose holder inside a maxi one, creates extra storage capacity without any increase in the space required.



Compressed air system »speedfit« and »sharkbite« series

The »speedfit« and »sharkbite« pipe systems are ideally suited to transporting compressed air. Both can be installed quickly and easily by yourself and offer significant savings in terms of energy and labor compared to conventional methods. Convert your compressed air piping systems with minimal production downtime and costs.

The »speedfit« and »sharkbite« series consist of reliable, long-lasting and efficient plug-in connectors, pipes and accessories. Both are durable and corrosion-resistant and no additional sealing material is required for their installation.

You get optimum flow rate and the utmost air quality. You also extend the lifespan of your systems and installations.

Plastic pipes made of polyamide PA 12

»speedfit« and »sharkbite« series - straight lengths

PLUS

Resistant to corrosion, vibration, impact, ageing, high pressures and heat.

Material	PA 12, hard (acc. to DIN 73378)
Operating temperature	-60 to 100 °C
Pipe length	3 m



89.1209-B



89.1209-S

Plastic pipe, polyamide PA 12

Art. No.	Type No.	Tube O.D. mm	Tube I.D. mm	Working pressure bar	Packaging unit pieces	Colour
113997	89.1209-B-10	12	9	-0.95 - 38	10	Blue
113987	89.1209-B	12	9	-0.95 - 38	20	Blue
113998	89.1209-S-10	12	9	-0.95 - 38	10	Black
113988	89.1209-S	12	9	-0.95 - 38	20	Black
113999	89.1512-B-10	15	12	-0.95 - 25	10	Blue
113989	89.1512-B	15	12	-0.95 - 25	20	Blue
114000	89.1512-S-10	15	12	-0.95 - 25	10	Black
113990	89.1512-S	15	12	-0.95 - 25	20	Black
114001	89.1814-B-10	18	14	-0.95 - 28	10	Blue
113991	89.1814-B	18	14	-0.95 - 28	20	Blue
114002	89.1814-S-10	18	14	-0.95 - 28	10	Black
113992	89.1814-S	18	14	-0.95 - 28	20	Black
114003	89.2218-B-10	22	18	-0.95 - 22	10	Blue
113993	89.2218-B	22	18	-0.95 - 22	20	Blue
114004	89.2218-S-10	22	18	-0.95 - 22	10	Black
113994	89.2218-S	22	18	-0.95 - 22	20	Black
114005	89.2823-B-5	28	23	-0.95 - 20	5	Blue
113995	89.2823-B	28	23	-0.95 - 20	10	Blue
114006	89.2823-S-5	28	23	-0.95 - 20	5	Black
113996	89.2823-S	28	23	-0.95 - 20	10	Black

- ➔ All prices apply per pack! Only sold in complete packaging units!
- ➔ Operating pressure with 2.5 x overpressure safety!

Plastic pipes made of polyamide PA 12

»speedfit« and »sharkbite« series - coils

PLUS

Resistant to corrosion, vibration, impact, ageing, high pressures and heat.

Material	PA 12, hard (acc. to DIN 73378)
Operating temperature	-60 to 100 °C

Plastic pipe, polyamide PA 12 - blue coils -

Art. No.	Type No.	Tube O.D. mm	Tube I.D. mm	Working pressure bar	Reel length m
114007	94.12-25	12	9	-0.95 - 19	25
114008	94.15-25	15	12	-0.95 - 15	25
114009	94.18-25	18	14	-0.95 - 16	25
114010	94.22-25	22	18	-0.95 - 14	25
114011	94.12-100	12	9	-0.95 - 19	100
114012	94.15-100	15	12	-0.95 - 15	100
114013	94.18-100	18	14	-0.95 - 16	100
114014	94.22-100	22	18	-0.95 - 14	100
114015	94.28-50	28	23	-0.95 - 14	50



94.12-25

→ Operating pressure with 2.5x overpressure safety!

Aluminium pipes

»speedfit« and »sharkbite« series

PLUS

Aluminium pipes, resistant to corrosion, electrically insulating.

Material	Surface coated aluminium
Working pressure	-0.95 - 20 bar
Operating temperature	-20 to 70 °C
Pipe length	3 m
Colour	blue

Aluminium pipe, surface coated

Art. No.	Type No.	Tube O.D. mm	Tube I.D. mm	Packaging unit pces
152287	90.1513-BE-10	15	13	10
152263	90.1513-BE	15	13	20
152293	90.1816-BE-10	18	16	10
152264	90.1816-BE	18	16	20
152294	90.2220-BE-10	22	20	10
152265	90.2220-BE	22	20	20
152297	90.2826-BE-5	28	26	5
152266	90.2826-BE	28	26	10
117010 NEW	ALR3531	35	31	5
117011 NEW	ALR4238	42	38	5
117012 NEW	ALR5450	54	50	5



90.1513-BE

→ All prices apply per pack! Only sold in complete packaging units!



Plastic pipes made of LLDPE/LDPE

»speedfit« and »sharkbite« series

PLUS

Plastic pipe made of LLDPE/LDPE with approval according to DVGW work sheet W270, KTW, NSF and WRAS. LLDPE/LDPE pipes are suitable for potable water uses (cold water) with a maximum chlorine content of 4 parts per million (ppm).

Warm water above 20 °C and / or pressurising above the given maximum reduces the lifetime of this material. Also, placement in direct sunlight should be avoided.

Operating temperature -20 to 65 °C



97.15-100

Plastic pipe, LLDPE/LDPE - black coils -

Art. No.	Type No.	Tube O.D. mm	Tube I.D. mm	Working pressure bar	Reel length m	Material
136361	97.04-100	4	2.5	-0.95 - 15	100	LLDPE
136362	97.06-100	6	4	-0.95 - 15	100	LLDPE
136363	97.08-100	8	6	-0.95 - 10	100	LLDPE
136364	97.10-100	10	7	-0.95 - 10	100	LLDPE
136365	97.12-100	12	9	-0.95 - 10	100	LLDPE
136366	97.15-100	15	11.5	-0.95 - 10	100	LLDPE
136367	97.22-50	22	17.7	-0.95 - 6	50	LDPE

Push-in fittings

acetal polymer (POM)

Lightweight, push-in fittings distinguished by high strength, toughness, resistance to abrasion and impact resistance - ideal for a wide range of applications.

All our push-in fittings made of POM have the following approvals:

drinking water DVGW, KTW, FDA and NSF.

Plastic and metal tubes are connected together quickly and easily. Suitable for compressed air or liquids, with good resistance to a large number of chemicals.

Material Acetal polymer (POM)
 Operating temperature in air -20 to 70 °C
 Operating temperature in water 1 to 70 °C

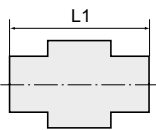

Male connectors

»speedfit« series

PLUS



65.018-6

Male connector, parallel male thread with O-ring (NBR)

Art. No.	Type No.	Thread	For tube O.D. mm	Working pressure bar	L1 mm	a/f mm
110259	65.018-4	G 1/8	4	-0.95 - 16	22.1	14
110260	65.018-5	G 1/8	5	-0.95 - 16	22.1	14
110261	65.018-6	G 1/8	6	-0.95 - 16	25.3	15
110262	65.018-8	G 1/8	8	-0.95 - 16	25.5	17
110263	65.014-4	G 1/4	4	-0.95 - 16	24.1	17
110264	65.014-5	G 1/4	5	-0.95 - 16	24.1	17
110265	65.014-6	G 1/4	6	-0.95 - 16	23.8	17
110266	65.014-8	G 1/4	8	-0.95 - 16	24.0	17
110267	65.014-10	G 1/4	10	-0.95 - 10	31.2	20
110268	65.038-8	G 3/8	8	-0.95 - 16	25.1	22
110269	65.038-10	G 3/8	10	-0.95 - 10	28.2	22
110270	65.038-12	G 3/8	12	-0.95 - 10	30.6	24
135950	65.038-15	G 3/8	15	-0.95 - 10	42.2	22
110271	65.012-10	G 1/2	10	-0.95 - 10	29.0	27

Male connectors

»speedfit« series

PLUS

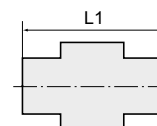

Male connector, parallel male thread with O-ring (NBR)

Art. No.	Type No.	Thread	For tube O.D. mm	Working pressure bar	L1 mm	a/f mm
110272	65.012-12	G 1/2	12	-0.95 - 10	34.0	27
110273	65.012-15	G 1/2	15	-0.95 - 10	38.0	27
110274	65.012-18	G 1/2	18	-0.95 - 10	54.8	-
135951	65.034-15	G 3/4	15	-0.95 - 10	46.2	30
110275	65.034-22	G 3/4	22	-0.95 - 10	61.2	-
135952	65.001-28	G 1	28	-0.95 - 10	70.0	-

Unions

»speedfit« series

PLUS

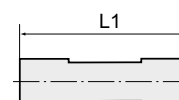

Unions

Art. No.	Type No.	For tube O.D. mm	Working pressure bar	L1 mm
110278	67.004	4	-0.95 - 16	32.6
110279	67.005	5	-0.95 - 16	32.6
110280	67.006	6	-0.95 - 16	35.0
110281	67.008	8	-0.95 - 16	38.0
110282	67.010	10	-0.95 - 10	41.9
110283	67.012	12	-0.95 - 10	53.8
110284	67.015	15	-0.95 - 10	58.0
110285	67.018	18	-0.95 - 10	64.1
110286	67.022	22	-0.95 - 10	70.6
110287	67.028	28	-0.95 - 10	90.8



67.006

Male elbows

»speedfit« series

PLUS

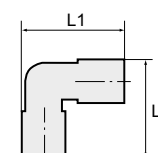

Male elbow, parallel male thread with O-ring (NBR)

Art. No.	Type No.	Thread	For tube O.D. mm	Working pressure bar	L1 mm	L2 mm	a/f mm
135956	72.018-4	G 1/8	4	-0.95 - 16	24.0	35.5	14
135957	72.018-5	G 1/8	5	-0.95 - 16	24.0	39.0	17
110289	72.018-6	G 1/8	6	-0.95 - 16	27.0	39.5	15
110290	72.018-8	G 1/8	8	-0.95 - 16	30.0	41.5	17
135958	72.014-4	G 1/4	4	-0.95 - 16	24.0	39.0	17
135959	72.014-5	G 1/4	5	-0.95 - 16	24.0	39.0	17
110291	72.014-6	G 1/4	6	-0.95 - 16	27.0	43.0	17
110292	72.014-8	G 1/4	8	-0.95 - 16	30.0	45.0	17
110293	72.014-10	G 1/4	10	-0.95 - 10	35.0	50.0	20
110294	72.038-8	G 3/8	8	-0.95 - 16	30.0	46.5	22
110295	72.038-10	G 3/8	10	-0.95 - 10	35.0	46.5	22
110296	72.038-12	G 3/8	12	-0.95 - 10	44.0	59.5	24
110297	72.038-15	G 3/8	15	-0.95 - 10	50.6	76.8	22



72.014-6



7

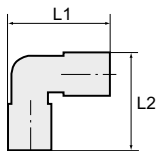

Male elbows

»speedfit« series

PLUS



72.014-6

Male elbow, parallel male thread with O-ring (NBR)

Art. No.	Type No.	Thread	For tube O.D. mm	Working pressure bar	L1 mm	L2 mm	a/f mm
110298	72.012-10	G 1/2	10	-0.95 - 10	35.0	54.5	27
110299	72.012-12	G 1/2	12	-0.95 - 10	44.0	62.5	27
110300	72.012-15	G 1/2	15	-0.95 - 10	50.6	79.8	27
110301	72.012-18	G 1/2	18	-0.95 - 10	59.7	92.2	27
135960	72.012-22	G 1/2	22	-0.95 - 10	66.0	94.5	27
135961	72.034-22	G 3/4	22	-0.95 - 10	66.0	117.4	37

Union elbows

»speedfit« series

PLUS



68.006

Union elbows

Art. No.	Type No.	For tube O.D. mm	Working pressure bar	L1 mm	L2 mm
110302	68.004	4	-0.95 - 16	24.1	24.1
110303	68.005	5	-0.95 - 16	24.1	24.1
110304	68.006	6	-0.95 - 16	27.1	27.1
110305	68.008	8	-0.95 - 16	29.9	29.9
110306	68.010	10	-0.95 - 10	35.3	35.3
110307	68.012	12	-0.95 - 10	44.0	44.0
110308	68.015	15	-0.95 - 10	50.3	50.3
110309	68.018	18	-0.95 - 10	59.7	59.7
110310	68.022	22	-0.95 - 10	66.6	66.6
110311	68.028	28	-0.95 - 10	87.7	87.7

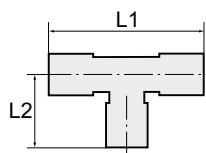

Union tees

»speedfit« series

PLUS



69.006

Union tees

Art. No.	Type No.	For tube O.D. mm	Working pressure bar	L1 mm	L2 mm
110313	69.004	4	-0.95 - 16	32.5	17.6
110314	69.005	5	-0.95 - 16	32.5	17.6
110315	69.006	6	-0.95 - 16	39.3	19.6
110316	69.008	8	-0.95 - 16	42.0	21.0
110317	69.010	10	-0.95 - 10	50.7	25.4
110318	69.012	12	-0.95 - 10	65.0	32.5
110319	69.015	15	-0.95 - 10	74.6	37.3
110320	69.018	18	-0.95 - 10	88.3	44.2
110321	69.022	22	-0.95 - 10	97.7	48.9
110322	69.028	28	-0.95 - 10	121.4	60.7

Y-connections

»speedfit« series

PLUS

Y-connection					
Art. No.	Type No.	For tube O.D. mm	Working pressure bar	L1 mm	L2 mm
136488	89.004	4	-0.95 - 16	37.0	28.5
136489	89.006	6	-0.95 - 16	35.5	26.8
136490	89.008	8	-0.95 - 16	50.0	41.0
136491	89.010	10	-0.95 - 10	46.0	39.5
136492	89.012	12	-0.95 - 10	55.5	44.2
136493	89.015	15	-0.95 - 10	70.3	54.8

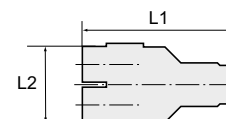

89.012

Bulkhead connectors

»speedfit« series

PLUS

Bulkhead connector						
Art. No.	Type No.	Thread	For tube O.D. mm	Working pressure bar	L1 mm	a/f mm
135972	71.038-4	G 3/8	4	-0.95 - 16	35.2	19
135973	71.038-5	G 3/8	5	-0.95 - 16	35.2	19
110324	71.038-6	G 3/8	6	-0.95 - 16	34.5	19
110325	71.012-8	G 1/2	8	-0.95 - 16	40.0	22
135974	71.012-10	G 1/2	10	-0.95 - 10	41.0	22
135975	71.034-12	G 3/4	12	-0.95 - 10	51.0	28

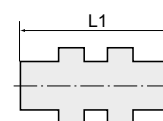

71.012-10

Union tees, unequal

»speedfit« series

PLUS

Union tee, unequal						
Art. No.	Type No.	For tube O.D. 1 mm	For tube O.D. 2 mm	Working pressure bar	L1 mm	L2 mm
110326	70.018-15	18	15	-0.95 - 10	84.5	37.9
110327	70.022-15	22	15	-0.95 - 10	90.6	41.6

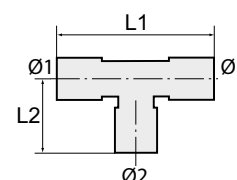

70.018-15

Reducers

»speedfit« series

PLUS

Reducer					
Art. No.	Type No.	Nozzle mm	For tube O.D. mm	Working pressure bar	L1 mm
136480	77.0504	5	4	-0.95 - 16	34.6
136481	77.0604	6	4	-0.95 - 16	36.4
136482	77.0605	6	5	-0.95 - 16	36.1
136483	77.0804	8	4	-0.95 - 16	37.2
136484	77.0805	8	5	-0.95 - 16	37.2
136485	77.0806	8	6	-0.95 - 16	37.4

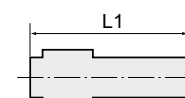

77.1210



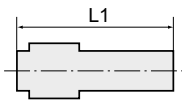

Reducers

»speedfit« series

PLUS



77.1210

Reducer						
Art. No.	Type No.	Nozzle mm	For tube O.D. mm	Working pressure bar	L1 mm	
136486	77.1006	10	6	-0.95 - 16	40.5	
136487	77.1008	10	8	-0.95 - 16	40.4	
110328	77.1208	12	8	-0.95 - 16	40.5	
110329	77.1210	12	10	-0.95 - 10	50.0	
110330	77.1510	15	10	-0.95 - 10	55.3	
110331	77.1512	15	12	-0.95 - 10	60.2	
110332	77.1815	18	15	-0.95 - 10	70.5	
110333	77.2215	22	15	-0.95 - 10	69.6	
110334	77.2218	22	18	-0.95 - 10	71.6	
110335	77.2815	28	15	-0.95 - 10	80.2	
110336	77.2822	28	22	-0.95 - 10	81.8	

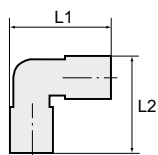

Union elbows

»speedfit« series

PLUS



78.0606

Union elbows						
Art. No.	Type No.	Nozzle mm	For tube O.D. mm	Working pressure bar	L1 mm	L2 mm
110339	78.0404	4	4	-0.95 - 16	26.0	22.0
110340	78.0505	5	5	-0.95 - 16	26.0	22.0
110341	78.0606	6	6	-0.95 - 16	29.0	25.0
110342	78.0808	8	8	-0.95 - 16	32.0	27.0
110343	78.1010	10	10	-0.95 - 10	35.5	32.0
110344	78.1212	12	12	-0.95 - 10	46.0	39.0
110345	78.1515	15	15	-0.95 - 10	52.1	42.2
110346	78.1818	18	18	-0.95 - 10	56.5	41.0
136479	78.2222	22	22	-0.95 - 10	58.7	67.0

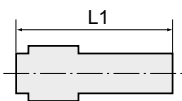

Screw-in supports

»speedfit« series

PLUS



75.012-10

Screw-in support (parallel thread)						
Art. No.	Type No.	Thread	For tube O.D. mm	Working pressure bar	L1 mm	a/f mm
136494	75.018-4	G 1/8	4	-0.95 - 16	25.5	14
136495	75.018-5	G 1/8	5	-0.95 - 16	25.5	14
136496	75.018-6	G 1/8	6	-0.95 - 16	27.5	15
136497	75.018-8	G 1/8	8	-0.95 - 16	28.5	17
136498	75.014-4	G 1/4	4	-0.95 - 16	29.0	17
136499	75.014-5	G 1/4	5	-0.95 - 16	29.0	17
136500	75.014-6	G 1/4	6	-0.95 - 16	30.0	17
136501	75.014-8	G 1/4	8	-0.95 - 16	31.0	17
136502	75.014-10	G 1/4	10	-0.95 - 10	34.0	20
136503	75.038-8	G 3/8	8	-0.95 - 16	32.5	22
136504	75.038-10	G 3/8	10	-0.95 - 10	35.5	22
136505	75.038-12	G 3/8	12	-0.95 - 10	40.5	24

Screw-in supports

»speedfit« series

PLUS



Screw-in support (parallel thread)

Art. No.	Type No.	Thread	For tube O.D. mm	Working pressure bar	L1 mm	a/f mm
136506	75.038-15	G 3/8	15	-0.95 - 10	54.5	22
136507	75.012-10	G 1/2	10	-0.95 - 10	38.5	27
136508	75.012-12	G 1/2	12	-0.95 - 10	43.5	27
136509	75.012-15	G 1/2	15	-0.95 - 10	57.5	27
136510	75.012-18	G 1/2	18	-0.95 - 10	64.5	27
136511	75.012-22	G 1/2	22	-0.95 - 10	74.5	27
136512	75.034-22	G 3/4	22	-0.95 - 10	69.0	37

Screw-on connections

»speedfit« series

PLUS

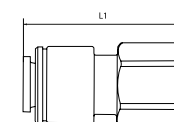

Material	Acetal polymer (POM)
Operating temperature in air	-20 to 70 °C
Operating temperature in water	1 to 70 °C

Screw-on connection

Art. No.	Type No.	Thread	For tube O.D. mm	Working pressure bar	L1 mm
136513	94.018-4	G 1/8	4	-0.95 - 16	28.0
136514	94.018-6	G 1/8	6	-0.95 - 16	31.3
136515	94.014-6	G 1/4	6	-0.95 - 16	32.0
136516	94.014-8	G 1/4	8	-0.95 - 16	33.0
136517	94.038-8	G 3/8	8	-0.95 - 16	30.8
136518	94.034-8	G 3/4	8	-0.95 - 16	36.0



94.038-8

Thread-reducers

»speedfit« series

PLUS

Thread-reducer with flat seal (NBR)

Art. No.	Type No.	Thread 1	Thread 2	Working pressure bar	L1 mm	L2 mm
136519	95.3414	G 3/4	G 1/4	-0.95 - 16	21.0	35.0

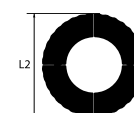
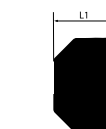

95.3414



7

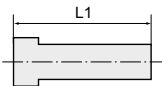

Plugs

»speedfit« series

PLUS



79.006

Plugs						
Art. No.	Type No.	Nozzle mm	Working pressure bar	L1 mm	Colour	
110348	79.004	4	-0.95 - 16	28.7	red	
110349	79.005	5	-0.95 - 16	29.2	red	
110350	79.006	6	-0.95 - 16	30.0	red	
110351	79.008	8	-0.95 - 16	31.0	red	
110352	79.010	10	-0.95 - 10	35.8	red	
110353	79.012	12	-0.95 - 10	38.6	red	
110354	79.015	15	-0.95 - 10	45.0	black	
110355	79.018	18	-0.95 - 10	41.5	black	
110356	79.022	22	-0.95 - 10	45.0	black	
110357	79.028	28	-0.95 - 10	55.6	black	

End stops for pipe connections

»speedfit« series

PLUS



80.015

End stop for pipe connections, POM				
Art. No.	Type No.	For tube O.D. mm	Length mm	
114062	80.012	12	28.0	
114063	80.015	15	31.0	
140638 NEW	80.018	18	33.3	
114064	80.022	22	38.6	

Collet locking clips

»speedfit« series

PLUS



91.010



91.022

Collet locking clip, POM				
Art. No.	Type No.	For tube O.D. mm	Colour	
135999	91.004	4	Red	
136000	91.005	5	Red	
136001	91.006	6	Red	
136002	91.008	8	Red	
136003	91.010	10	Red	
114051	91.012	12	Red	
114052	91.015	15	Grey	
114053	91.018	18	Grey	
114054	91.022	22	Grey	

Collet covers

»speedfit« series

PLUS

Colour	black
--------	-------

Collet cover, POM

Art. No.	Type No.	For tube O.D. mm
114055	92.012	12
114056	92.015	15
114057	92.018	18
114058	92.022	22



92.018

→ Collet covers for the series »speedfit«, fits on all acetal polymer (POM) push-in fittings

Release aids

»speedfit« series

PLUS

Release aid, POM

Art. No.	Type No.	For tube O.D. mm
114059	93.015	15
114060	93.022	22
114061	93.028	28



93.022

Water trap tee

»speedfit« series

PLUS

Solves the problem of moisture in branch lines.

Water trap tee for 22 mm pipe, POM

Art. No.	Type No.	For tube O.D. mm	L1 mm	L2 mm
114065	81.022	22	98.0	48.0

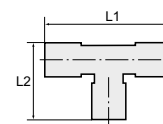

81.022

Water trap tee converter

»speedfit« series

PLUS

Solves the problem of moisture in branch lines. Must be used in conjunction with T connector (POM).

The converter is inserted into the plastic pipe and the pipe into the union tee.

By turning the screw cap a quarter turn, the pipe is doubly locked!

Water trap tee converter for 28 mm pipe, brass

Art. No.	Type No.	For tube O.D. mm	Length mm
114066	81.028	28	24.8



81.028



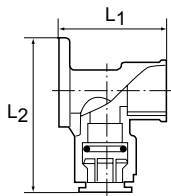

82.015



84.100-28

Brass unions

»speedfit« series

PLUS

Wall elbow, brass

Art. No.	Type No.	Thread	For tube O.D. mm	L1 mm	L2 mm
114067	82.015	1/2 BSP	15	47.0	66.4
114068	82.022	3/4 BSP	22	52.0	79.0

Male stem adapter, brass

Art. No.	Type No.	Thread	For tube O.D. mm	Length mm
114073	84.012-15	1/2 BSPT	15	38.0
114074	84.034-22	3/4 BSPT	22	52.0
114075	84.100-28	1 BSPT	28	68.1

NEW Brass unions

»sharkbite« series

PLUS

Material	Brass
Working pressure	-0.95 - 20 bar
Operating temperature	-20 to 65 °C



AVMNG34



ESVMNG12



GVMN15



GVMN42

Screw-on connection brass

Art. No.	Type No.	Thread	For tube O.D. mm	Length mm
117015	AVMNG12	G 1/2	15	40.0
117017	AVMNG34	G 3/4	22	47.0
117014	AVMNG114	G 1 1/4	35	70.0
117013	AVMNG112	G 1 1/2	42	77.0
117016	AVMNG2	G 2	54	83.0

Screw-in connector brass

Art. No.	Type No.	Thread	For tube O.D. mm	Length mm
117029	ESVMNG12	BSPT 1/2	15	43.0
117031	ESVMNG34	BSPT 3/4	22	47.0
117028	ESVMNG1	BSPT 1	28	55.0
117027	ESVMNG114	BSPT 1 1/4	35	76.0
117026	ESVMNG112	BSPT 1 1/2	42	77.0
117030	ESVMNG2	BSPT 2	54	82.0

Straight connector brass

Art. No.	Type No.	For tube O.D. mm	Length mm
117039	GVMN15	15	51.0
117040	GVMN22	22	61.0
117041	GVMN28	28	65.0
117042	GVMN35	35	99.0
117043	GVMN42	42	109.0
117044	GVMN54	54	114.0

NEW Brass unions

»sharkbite« series

PLUS

Reducer connector brass				
Art. No.	Type No.	For tube O.D. mm	For tube O.D. 1 mm	Length mm
117051	RDVMN2215	15	22	57.0
117052	RDVMN2822	22	28	66.0
117053	RDVMN3528	28	35	94.0
117055	RDVMN4235	35	42	105.0
117056	RDVMN5442	42	54	112.0



RDVMN3528



RDVMN4235



RPSVMN22

Repair/slide in connector brass			
Art. No.	Type No.	For tube O.D. mm	Length mm
117057	RPSVMN15	15	85.0
117058	RPSVMN22	22	102.0
117059	RPSVMN28	28	115.0
117060	RPSVMN35	35	163.0
117061	RPSVMN42	42	181.0
117062	RPSVMN54	54	191.0

T-reducer connector brass				
Art. No.	Type No.	For tube O.D. mm	For tube O.D. 1 mm	
117070	TRVMN2215	22	15	
117071	TRVMN2815	28	15	
117072	TRVMN2822	28	22	
117073	TRVMN3522	35	22	
117074	TRVMN3528	35	28	
117075	TRVMN4222	42	22	
117076	TRVMN4228	42	28	
117077	TRVMN4235	42	35	
117078	TRVMN5428	54	28	
117079	TRVMN5435	54	35	
117080	TRVMN5442	54	42	



TRVMN2815

T-connection brass				
Art. No.	Type No.	For tube O.D. mm	L1 mm	L2 mm
117081	TVMN15	15	68.0	34.0
117082	TVMN22	22	86.0	43.0
117083	TVMN28	28	94.0	47.0
117084	TVMN35	35	139.0	66.0
117085	TVMN42	42	153.0	77.0
117087	TVMN54	54	174.0	85.0

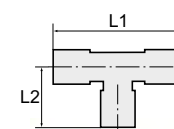

TVMN22

Angle connector 45° brass				
Art. No.	Type No.	For tube O.D. mm	L1 mm	L2 mm
117090	WVMN4515	15	28.0	28.0
117091	WVMN4522	22	43.0	43.0
117092	WVMN4528	28	40.0	40.0
117093	WVMN4535	35	61.0	61.0
117094	WVMN4542	42	67.0	67.0
117096	WVMN4554	54	72.0	72.0

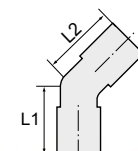

WVMN4515



7

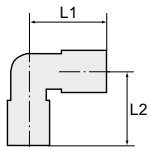

WVMN9015

NEW Brass unions

»sharkbite« series

PLUS

Angle connector 90° brass

Art. No.	Type No.	For tube O.D. mm	L1 mm	L2 mm
117097	WVMN9015	15	34.0	34.0
117098	WVMN9022	22	43.0	43.0
117099	WVMN9028	28	46.0	46.0
117100	WVMN9035	35	69.0	69.0
117108	WVMN9042	42	77.0	77.0
117113	WVMN9054	54	85.0	85.0

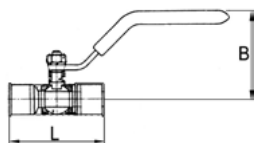

NEW Ball valves

»sharkbite« series

PLUS

Material	Brass
Working pressure	-0.95 - 20 bar
Operating temperature	-20 to 65 °C



KGHMN15

Ball valve

Art. No.	Type No.	For tube O.D. mm	L mm	B mm
117045	KGHMN15	15	79.0	46.0
117046	KGHMN22	22	98.0	51.0
117047	KGHMN28	28	114.0	57.0
117048	KGHMN35	35	150.0	78.0
117049	KGHMN42	42	169.0	86.0
117050	KGHMN54	54	184.0	95.0

NEW End caps

»sharkbite« series

PLUS

Material	Brass
Working pressure	-0.95 - 20 bar
Operating temperature	-20 to 65 °C



EKMN42

End cap

Art. No.	Type No.	For tube O.D. mm	Length mm
117033	EKMN15	15	26.0
117034	EKMN22	22	31.0
117035	EKMN28	28	33.0
117036	EKMN35	35	56.0
117037	EKMN42	42	62.0
117038	EKMN54	54	66.0

NEW Wall bracket

»sharkbite« series

PLUS

Material	Brass
Working pressure	-0.95 - 20 bar
Operating temperature	-20 to 65 °C

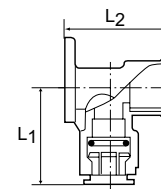

Wall bracket

Art. No.	Type No.	Thread	For tube O.D. mm	L1 mm	L2 mm
117088	WWMN15	G 1/2	15	35.0	45.0
117089	WWMN22	G 3/4		42.0	57.0



WWMN15

NEW Disassembly clip

»sharkbite« series

PLUS

Disassembly clip

Art. No.	Type No.	For tube O.D. mm
117018	DMC15	15
117019	DMC22	22
117020	DMC28	28



DMC15

NEW Disassembly aid

»sharkbite« series

PLUS

Disassembly aid

Art. No.	Type No.	For tube O.D. mm
117021	DMH35	35
117024	DMH42	42
117025	DMH54	54



DMH35

NEW Deburring tool

»sharkbite« series

PLUS

Material	Brass
----------	-------

Deburring tool

Art. No.	Type No.	For tube O.D. mm
117008	EGW3554	35 - 54



EGW3554



Pipe clips

»speedfit« series

PLUS

For fastening rigid PA or aluminium pipes to the wall.



88.015

Pipe clip, Polypropylen

Art. No.	Type No.	For tube O.D. mm
114029	88.012	12
114030	88.015	15
114031	88.018	18
114032	88.022	22
114033	88.028	28



88.015-S

Pipe clips, coloured

»speedfit« and »sharkbite« series

PLUS

For fastening rigid PA or aluminium pipes to the wall.



RHKL4854



88.015-B



88.015-R



88.015-W

Pipe clip, coloured, Polypropylen

Art. No.	Type No.	For tube O.D. mm	Colour
114035	88.015-S	15	Black
114036	88.018-S	18	Black
114037	88.022-S	22	Black
114038	88.028-S	28	Black
117067 NEW	RHKL3538	35 - 40	Black
117068 NEW	RHKL4044	40 - 44	Black
117069 NEW	RHKL4854	48 - 54	Black
114039	88.015-B	15	Blue
114040	88.018-B	18	Blue
114041	88.022-B	22	Blue
114042	88.028-B	28	Blue
114043	88.015-R	15	Red
114044	88.018-R	18	Red
114045	88.022-R	22	Red
114046	88.028-R	28	Red
114047	88.015-W	15	White
114048	88.018-W	18	White
114049	88.022-W	22	White
114050	88.028-W	28	White

Porting box

»speedfit« series

PLUS

With five G 1/2 female threads for screwing on adapters and four self-sealing plastic screws for the threaded openings as well as G 1/2 for a quick disconnect coupling.



86.012

Porting box, plastic

Art. No.	Type No.	Colour
114026	86.012	Black

Porting boxes

»speedfit« and »sharkbite« series

PLUS

With two plugs.

Porting box, aluminium				
Art. No.	Type No.	Input	Output	
114027	87.012	G 1/2	3 x G 1/2	
114028	87.034	G 3/4	3 x G 1/2	



87.012

Brass unions

»speedfit« and »sharkbite« series

PLUS

Wingback elbow, brass					
Art. No.	Type No.	Thread	For tube O.D. mm	Length mm	
114069	83.012-15	1/2 BSPT	15	60.0	
114070	83.034-22	3/4 BSPT	22	68.0	
114071	83.034-28	3/4 BSP	28	80.0	
114072	83.100-28	1 BSP	28	74.5	



83.012-15

Straight adapter, female thread, brass					
Art. No.	Type No.	Thread	For tube O.D. mm	Length mm	
114076	85.012-15	1/2 BSP	15	54.0	
114077	85.034-22	3/4 BSP	22	64.5	



85.012-15

Plastic pipe cutter

»speedfit« and »sharkbite« series

PLUS

Plastic pipe cutter		
Art. No.	Type No.	Description
114079	259.900	For tube O.D. 4 - 28 mm
114080	259.901	Replacement blade (1 x)



259.900



259.901

Aluminium pipe cutter

»speedfit« and »sharkbite« series

PLUS

Aluminium pipe cutter, incl. deburrer		
Art. No.	Type No.	Description
114078	259.800	For tube O.D. 4 - 30 mm



259.800



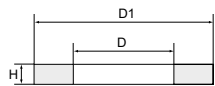

Sealing rings

made of fibre, polyamide, aluminium, copper, PTFE, PVC and PA6



258.04/1

Sealing ring, fibre, max. temperature 75 °C

Art. No.	Type No.	For thread	Material	D mm	D1 mm	H mm
114081	258.00	M5	Fibre	5.1	8.0	1.0
114082	258.01	G 1/8	Fibre	10.0	13.0	1.5
114083	258.02	G 1/4	Fibre	13.2	18.0	1.5
114084	258.03	G 3/8	Fibre	16.8	22.0	1.5
114085	258.04	G 1/2	Fibre	21.0	28.0	2.0
114086	258.04/1	G 3/4	Fibre	26.5	33.0	2.0
114087	258.04/2	G 1	Fibre	33.3	38.9	2.0



258.10

Sealing ring, polyamide, max. temperature 80 °C

Art. No.	Type No.	For thread	Material	D mm	D1 mm	H mm
114088	258.05	M5	Polyamide	5.1	8.0	1.0
114089	258.06	G 1/8	Polyamide	10.0	13.0	1.5
114090	258.07	G 1/4	Polyamide	13.2	18.0	1.5
114091	258.08	G 3/8	Polyamide	16.8	22.0	1.5
114092	258.09	G 1/2	Polyamide	21.0	28.0	1.5
114093	258.10	G 3/4	Polyamide	26.8	33.0	2.0
114094	258.10/1	G 1	Polyamide	33.3	38.9	2.0



258.16

Sealing ring, aluminium, max. temperature 250 °C

Art. No.	Type No.	For thread	Material	D mm	D1 mm	H mm
114095	258.11	M5	Aluminium	5.1	8.0	1.0
114096	258.12	G 1/8	Aluminium	10.0	13.8	1.5
114097	258.13	G 1/4	Aluminium	13.3	18.0	1.5
114098	258.14	G 3/8	Aluminium	17.0	21.8	1.5
114099	258.15	G 1/2	Aluminium	21.0	28.0	1.5
114100	258.16	G 3/4	Aluminium	26.5	33.0	2.0
114101	258.17	G 1	Aluminium	33.3	38.9	2.0



258.33

Sealing ring, copper, max. temperature 250 °C

Art. No.	Type No.	For thread	Material	D mm	D1 mm	H mm
114102	258.30	M5	Copper	5.2	8.0	1.0
114103	258.31	G 1/8	Copper	10.2	13.4	1.5
114104	258.32	G 1/4	Copper	13.2	17.9	1.5
114105	258.33	G 3/8	Copper	16.8	22.0	1.5
114106	258.34	G 1/2	Copper	21.2	27.9	1.5
114107	258.35	G 3/4	Copper	26.5	33.0	2.0
114108	258.36	G 1	Copper	33.3	38.9	2.0



258.45

Sealing ring, PTFE, max. temperature 260 °C

Art. No.	Type No.	For thread	Material	D mm	D1 mm	H mm
114109	258.40	M5	PTFE	5.1	8.0	1.0
114110	258.41	G 1/8	PTFE	10.0	13.0	1.5
114111	258.42	G 1/4	PTFE	13.2	18.0	1.5
114112	258.43	G 3/8	PTFE	16.8	22.0	1.5
114113	258.44	G 1/2	PTFE	21.0	28.0	1.5
114114	258.45	G 3/4	PTFE	26.5	33.0	2.0
114115	258.46	G 1	PTFE	33.3	38.9	2.0

Sealing rings

made of fibre, polyamide, aluminium, copper, PTFE, PVC and PA6

Captive seal, max. temperature 70 °C						
Art. No.	Type No.	For thread	Material	D mm	D1 mm	H mm
114116	258.50	M5	PA6	5.0	8.0	1.2
114117	258.51	G 1/8	PA6	9.9	13.9	1.8
114118	258.52	G 1/4	PA6	13.1	17.9	1.8
114119	258.53	G 3/8	PA6	16.8	21.4	1.8
114120	258.54	G 1/2	PA6	21.0	25.4	2.0
114121	258.55	G 3/4	PVC	26.6	32.0	2.0
114122	258.56	G 1	PVC	33.4	40.0	2.0



258.54

→ All seals are only sold in packaging units of 100 x

PTFE sealing tape

Thread sealing tape made of pure, sintered PTFE, silicone free. DIN/DVGW tested and approved. Resistant to chemicals, even aggressive media. Does not become brittle, swell or stick.

Operating temperature	-60 to 200 °C
-----------------------	---------------

PTFE sealing tape				
Art. No.	Type No.	Length m	Width mm	Thickness mm
114123	258.66	12	12.0	0.1



258.66

Thread sealant

Universal, non-curing thread sealant in the form of impregnated nylon yarn. All combinations of metal and plastic threads.

- Drinking and waste water
- Gas, compressed air and industrial oils
- Aqueous and non-aqueous fluids up to 130°C

Clean processing, adjustable, non-curing, odourless, good chemical resistance. DVGW approval acc. to DIN 751-1 and DIN 30660, DV-5142 AU 0166 test mark. KTW approval for hot water up to 95°C and pressures up to 16 bar.

Thread sealant		
Art. No.	Type No.	Contents m
114124	258.77	160



258.77



Two-ear hose clamps

galvanised steel (W1)

Quick and safe assembly: the two parts are simply pressed together.

Material Galvanised steel (W1)



157 E

Two-ear hose clamp, galvanised steel

Art. No.	Type No.	Clamping range mm	Band width mm
114125	157 A	5 - 7	6.0
114126	157 B	7 - 9	6.0
114127	157 C	9 - 11	6.5
114128	157 D	11 - 13	6.5
114129	157 E	13 - 15	7.0
114130	157 F	14 - 17	7.0
114131	157 G	17 - 20	7.5
114132	157 H	20 - 23	8.0
114133	157 J	22 - 25	8.5
114134	157 K	25 - 28	9.0
114135	157 M	28 - 31	9.0
114136	157 N	31 - 34	9.5
114137	157 P	34 - 37	9.5
114138	157 R	37 - 40	10.0
114139	157 S	40 - 43	10.0
114140	157 T	43 - 46	10.5

Two-ear hose clamps

Stainless steel (W4)

Material Stainless steel 1.4301 (W4)



157 G-ES

Two-ear hose clamp, stainless steel

Art. No.	Type No.	Clamping range mm	Band width mm
114141	157 A-ES	5 - 7	6.0
114142	157 B-ES	7 - 9	6.0
114143	157 C-ES	9 - 11	6.5
114144	157 D-ES	11 - 13	6.5
114145	157 E-ES	13 - 15	7.0
114146	157 F-ES	14 - 17	7.0
114147	157 G-ES	17 - 20	7.5
114148	157 H-ES	20 - 23	8.0
114149	157 J-ES	22 - 25	8.5

One-ear hose clamps

Bright galvanised steel (W1)

Material	Galvanised steel (W1)
----------	-----------------------

One-ear hose clamp, bright galvanised steel

Art. No.	Type No.	Clamping range mm	Band width mm
114150	156 A	7 - 9	6.0
114151	156 B	8 - 10	6.0
114152	156 C	9 - 11	6.5
114153	156 D	10 - 12	6.5
114154	156 E	11 - 13	6.5
114155	156 F	12 - 14	7.0
114156	156 G	14 - 16	7.0
114157	156 H	16 - 18	7.0



156 D

One-ear hose clamps

Stainless steel (W4)

Material	Stainless steel 1.4301 (W4)
----------	-----------------------------

One-ear hose clamp, stainless steel

Art. No.	Type No.	Clamping range mm	Band width mm
114158	156 A-ES	7 - 9	6.0
114159	156 B-ES	8 - 10	6.0
114160	156 C-ES	9 - 11	6.5
114161	156 D-ES	10 - 12	6.5
114162	156 E-ES	11 - 13	6.5
114163	156 F-ES	12 - 14	7.0
114164	156 G-ES	14 - 16	7.0
114165	156 H-ES	16 - 18	7.0



156 C-ES

One-ear hose clamps with insert ring

bright galvanised steel (W1)

An absolutely safe all around setting is ensured by the pre-mounted insert ring. Suitably for use with soft and sensitive hose material.

Material	Galvanised steel (W1)
----------	-----------------------

One-ear hose clamp with insert ring, bright galvanised steel

Art. No.	Type No.	Clamping range mm	Band width mm
114166	155 A	7,5 - 8,5	7.8
114167	155 B	8,2 - 9,5	7.8
114168	155 C	9 - 10,5	7.8
114169	155 D	10 - 11,5	7.8
114170	155 E	10,5 - 12,5	7.8
114171	155 F	11,5 - 13,3	8.8
114172	155 G	13 - 15,3	8.8
114173	155 H	15 - 17,3	8.8



155 F



One-ear hose clamps with insert ring

stainless steel (W4)



155 A-ES-1

Material Stainless steel 1.4301 (W4)

One-ear hose clamp with insert ring, stainless steel

Art. No.	Type No.	Clamping range mm	Band width mm
152227	155 A-ES-1	7,5 - 8,5	7.8
152228	155 B-ES-1	8,2 - 9,5	7.8
152229	155 C-ES-1	9 - 10,5	7.8
152230	155 D-ES-1	10 - 11,5	7.8
152231	155 E-ES-1	10,5 - 12,5	7.8
152232	155 F-ES-1	11,5 - 13,3	8.8
152233	155 G-ES-1	13 - 15,3	8.8
152234	155 H-ES-1	15 - 17,3	8.8
152235	155 I-ES-1	16 - 18,3	9.8
152236	155 K-ES-1	17 - 19,3	9.8

Pliers



BZ 158

Pliers

Art. No.	Type No.	Description
114200	BZ 158	With additional side pincer for inaccessible points

Clamping jaws

Bright galvanised steel (W1)

Lightweight type acc. to DIN 3017.

Applications: Soft air and fuel hose types, optimal seal, high clamping force around the hose, suitable for car dealerships, repair shops and pneumatic applications.

Material	Galvanised steel (W1)
----------	-----------------------

Clamping jaw, galvanised steel				
Art. No.	Type No.	Nominal Ø mm	Clamping range mm	Band width mm
114184	SBS-8	8.0	7 - 9	9.0
114185	SBS-9	9.0	8 - 10	9.0
114186	SBS-10	10.0	9 - 11	9.0
114187	SBS-11	11.0	10 - 12	9.0
114188	SBS-12	12.0	11 - 13	9.0
114189	SBS-13	13.0	12 - 14	9.0
114190	SBS-14	14.0	13 - 15	9.0
114191	SBS-15	15.0	14 - 16	9.0
114192	SBS-16	16.0	15 - 17	9.0
114193	SBS-17	17.0	16 - 18	9.0
114194	SBS-18	18.0	17 - 19	9.0
114195	SBS-19	19.0	18 - 20	9.0
114196	SBS-20	20.0	19 - 21	9.0
114197	SBS-21	21.0	20 - 22	9.0
114198	SBS-22	22.0	21 - 23	9.0
114199	SBS-23	23.0	22 - 24	9.0



SBS-12

Hose clamps

»Standard« series, chromium steel 1.4016 (W 2), band width 9 and 12 mm

Worm drive type.

For all standard applications where high clamping forces are normally distributed.

Hexagon-head screw a/f 7, with integrated cross-tip, bright galvanised steel, passivated blue.

Material	Chromium steel 1.4016 (W2)
----------	----------------------------

Worm drive hose clamp, chromium steel, 1.4016 (W 2), 9 mm				
Art. No.	Type No.	Clamping range mm	Type No.	Band width mm
114201	158 A	8 - 12		9.0
114202	158 B	10 - 16		9.0
114203	158 C	12 - 20		9.0
114204	158 D	16 - 25		9.0
114205	158 E	20 - 32		9.0
114206	158 G	25 - 40		9.0
114207	158 J	32 - 50		9.0
114208	158 K	40 - 60		9.0
114209	158 L	50 - 70		9.0
114210	158 M	60 - 80		9.0
114211	158 N	70 - 90		9.0
114212	158 P	80 - 100		9.0
114213	158 R	90 - 110		9.0



158 G



Hose clamps

»Standard« series, chromium steel 1.4016 (W 2), band width 9 and 12 mm



1580 J-12

Worm drive hose clamp, chromium steel, 1.4016 (W 2), 12 mm

Art. No.	Type No.	Clamping range mm	Band width mm
114214	1580 C-12	12 - 20	12.0
114215	1580 D-12	16 - 25	12.0
114216	1580 E-12	20 - 32	12.0
114217	1580 G-12	25 - 40	12.0
114218	1580 J-12	32 - 50	12.0
114219	1580 K-12	40 - 60	12.0
114220	1580 L-12	50 - 70	12.0
114221	1580 M-12	60 - 80	12.0
114222	1580 N-12	70 - 90	12.0
114223	1580 P-12	80 - 100	12.0
114224	1580 R-12	90 - 110	12.0

Hose clamps

stainless steel 1.4401 (W 5), band width 9 mm

Worm drive type.

For all standard applications where high clamping forces are normally distributed.
Hexagon-head screw a/f 7, with integrated cross-tip, Stainless steel 1.4401 (W 5).

Material Stainless steel 1.4401 (W5)



158 G-ES

Worm drive hose clamp, stainless steel 1.4401

Art. No.	Type No.	Clamping range mm	Band width mm
114225	158 A-ES	8 - 12	9.0
114226	158 B-ES	10 - 16	9.0
114227	158 C-ES	12 - 20	9.0
114228	158 D-ES	16 - 25	9.0
114229	158 E-ES	20 - 32	9.0
114230	158 G-ES	25 - 40	9.0
114231	158 J-ES	32 - 50	9.0
114232	158 K-ES	40 - 60	9.0
114233	158 L-ES	50 - 70	9.0
114234	158 M-ES	60 - 80	9.0
114235	158 N-ES	70 - 90	9.0
114236	158 P-ES	80 - 100	9.0
114237	158 R-ES	90 - 110	9.0

Hose clamps

»Maxi« series, bright galvanised steel (W 1), band width 20 mm

Worm-drive type.

Extremely robust hose clamps for all applications where heavy loads occur and high forces are transmitted. Hexagon-head screw slotted, a/f 13, bright galvanised steel, passivated blue.

Material Galvanised steel (W1)

Worm drive hose clamp, bright galvanised steel (W 1), band width 20 mm

Art. No.	Type No.	Clamping range mm	Band width mm
114238	159 A	60 - 80	20.0
114239	159 B	70 - 90	20.0
114240	159 C	90 - 120	20.0
114241	159 D	105 - 130	20.0
114242	159 E	122 - 157	20.0
114243	159 G	142 - 177	20.0
114244	159 J	167 - 202	20.0
114245	159 K	192 - 227	20.0
114246	159 L	217 - 252	20.0
114247	159 M	242 - 277	20.0
114248	159 N	267 - 302	20.0
114249	159 P	292 - 327	20.0



159 A

Screwdriver

Screwdriver

Art. No.	Type No.	Description
114251	SD 7	Screwdriver



SD 7



Boxed set, hose clamps

Practical, high-quality assortment of our most popular hose clamps (worm drive and two-ear) packaged in a sturdy plastic case.

Total of 13 different small part types, conveniently arranged in 11 plastic compartments. The inserts can be removed and rearranged inside the case according to individual needs. All inserts are labelled with the article numbers of the parts they contain.

Parts included:

95 worm drive hose clamps made of chromium steel
 8 - 12 • 10 - 16 • 12 - 20 • 16 - 25 • 20 - 32 • 32 - 50 mm,
 250 two-ear hose clamps made of galvanised steel
 5 - 7 • 7 - 9 • 9 - 11 • 11 - 13 • 14 - 17 mm,
 1 screwdriver
 1 pliers



SKB 400

Boxed set, hose clamps

Art. No.	Type No.	Description
114250	SKB 400	Boxed set, hose clamps

- ➔ Boxed set quick disconnect couplings DN 7.2 see on page 496
- ➔ Boxed sets push-in fittings »Blue Series« see on page 622-623
- ➔ Boxed set push-in fittings »click-clock« series see on page 648
- ➔ Boxed sets, brass turned parts see on page 712

Boxed set, hose clamps

Reduced assortment

Easy to handle plastic assortment box with reduced fitting, includes the most common articles of our hose clamps and hose clips.

Parts included:

82 x worm drive hose clamps made of chromium steel
 8 - 12 • 10 - 16 • 12 - 20 • 16 - 25 • 20 - 32 • 25 - 40 mm,
 175 x two-ear hose clamps made of galvanised steel
 5 - 7 • 7 - 9 • 9 - 11 • 11 - 13 • 13 - 15 • 14 - 17 mm



SKBR 400

Boxed set, hose clamps

Art. No.	Type No.	Description
131535	SKBR 400	Boxed set hose clamps, reduced assortment

- ➔ Boxed set quick disconnect couplings DN 7.2 see on page 496
- ➔ Boxed sets push-in fittings »Blue Series« see on page 622-623
- ➔ Boxed set push-in fittings »click-clock« series see on page 648
- ➔ Boxed sets, brass turned parts see on page 712

Hinge bolt clamps

Series »GBS« chromium steel 1.4016 (W 2)

For use with our industrial water, rubber, suction and discharge hoses.

Steel band	Chromium steel 1.4016
Housing	Chromium steel 1.4016
Bolt	Galvanised steel
Pin	Galvanised steel

Hinge bolt clamp, Chromium steel 1.4016 (W 2)				
Art. No.	Type No.	Clamping range mm	Band width mm	Recommended tightening torque Nm
194277	GBS19ST	17 - 19	18.0	4.5
194278	GBS22ST	20 - 22	18.0	4.5
194279	GBS25ST	23 - 25	18.0	4.5
194280	GBS28ST	26 - 28	18.0	4.5
194281	GBS31ST	29 - 31	20.0	9
194282	GBS35ST	32 - 35	20.0	9
194283	GBS39ST	36 - 39	20.0	9
194284	GBS43ST	40 - 43	20.0	9
194285	GBS47ST	44 - 47	22.0	9
194286	GBS51ST	48 - 51	22.0	9
194287	GBS55ST	52 - 55	22.0	9
194288	GBS59ST	56 - 59	22.0	9
194289	GBS63ST	60 - 63	22.0	9
194290	GBS67ST	64 - 67	22.0	9
194291	GBS73ST	68 - 73	24.0	18
194292	GBS79ST	74 - 79	24.0	18
194293	GBS85ST	80 - 85	24.0	18
194294	GBS91ST	86 - 91	24.0	18
194295	GBS97ST	92 - 97	24.0	18
194296	GBS103ST	98 - 103	24.0	18
194297	GBS112ST	104 - 112	24.0	18
194298	GBS121ST	113 - 121	24.0	18



GBS43ST

- For industrial water hoses up to DN 100 see page 843
- For plastic suction and discharge hoses up to DN 100 see page 848
- For rubber suction and discharge hoses up to DN 100 see page 849



Hinge bolt clamps

Series »Super« stainless steel (W4)

For use with our industrial water, rubber, suction and discharge hoses.

Steel band	Stainless steel 1.4301 (W4)
Housing	Stainless steel 1.4301 (W4)
Bolt	Stainless steel 1.4301 (W4)
Pin	Stainless steel 1.4301 (W4)



GBS43ES

Hinge bolt clamp, stainless steel (W4)

Art. No.	Type No.	Clamping range mm	Band width mm	Recommended tightening torque Nm
194310	GBS19ES	17 - 19	18.0	4.5
194311	GBS22ES	20 - 22	18.0	4.5
194312	GBS25ES	23 - 25	18.0	4.5
194313	GBS28ES	26 - 28	18.0	4.5
194314	GBS31ES	29 - 31	20.0	9
194315	GBS35ES	32 - 35	20.0	9
194316	GBS39ES	36 - 39	20.0	9
194317	GBS43ES	40 - 43	20.0	9
194318	GBS47ES	44 - 47	22.0	9
194319	GBS51ES	48 - 51	22.0	9
194320	GBS55ES	52 - 55	22.0	9
194321	GBS59ES	56 - 59	22.0	9
194322	GBS63ES	60 - 63	22.0	9
194323	GBS67ES	64 - 67	22.0	9
194324	GBS73ES	68 - 73	24.0	18
194325	GBS79ES	74 - 79	24.0	18
194326	GBS85ES	80 - 85	24.0	18
194327	GBS91ES	86 - 91	24.0	18
194328	GBS97ES	92 - 97	24.0	18
194329	GBS103ES	98 - 103	24.0	18
194343	GBS112ES	104 - 112	24.0	18
194344	GBS121ES	113 - 121	24.0	18

- ➔ For industrial water hoses up to DN 100 see page 843
- ➔ For plastic suction and discharge hoses up to DN 100 see page 848
- ➔ For rubber suction and discharge hoses up to DN 100 see page 849

RSGU pipe retaining clips

galvanised steel with rubber profile (W1)

Acc. to DIN 3016, type D1.

For fastening hoses, pipes, compressed air lines and cables.

Rubber profile protects against vibrations and creeping water.

Material	Galvanised steel (W1)
----------	-----------------------

RSGU pipe retaining clip, galvanised steel			
Art. No.	Type No.	Clamping range max. mm	Band width mm
114302	RSG-6	6.0	12.0
114303	RSG-8	8.0	12.0
114304	RSG-10	10.0	12.0
114305	RSG-12	12.0	12.0
114306	RSG-14	14.0	12.0
114307	RSG-15	15.0	15.0
114308	RSG-18	18.0	15.0
114309	RSG-19	19.0	15.0
114310	RSG-20	20.0	15.0
114311	RSG-22	22.0	15.0
114312	RSG-25	25.0	15.0
114313	RSG-28	28.0	15.0
114314	RSG-30	30.0	15.0
114315	RSG-32	32.0	20.0
114316	RSG-34	34.0	20.0
114317	RSG-35	35.0	20.0
114318	RSG-38	38.0	20.0
114319	RSG-40	40.0	20.0



RSG-12



Blow guns

die-cast aluminium nickel-plated

EASY

Standard type.

For blowing out and cleaning machines, workpieces, bore holes, hollow parts, etc.

Material	Nickel-plated die-cast aluminium
Max. operating pressure	10 bar
Working pressure	2 - 6 bar
Temperature range	-10 to 50 °C
Nozzle	M12x1.25
Extension	M12x1.25



22 A

Blow gun with standard nozzle, bore 1.5 mm

Art. No.	Type No.	Type of connection
114320	22 A	Stem, I.D. 6
114321	22 B	Stem, I.D. 9
114322	22 C	Stem, I.D. 13
117445	22 K/TD	G 1/4 IT
114323	22 K	Push-in plug for DN 7.2 - 7.8 couplings



22 A/D

Blow gun with silencer nozzle

Art. No.	Type No.	Type of connection
114324	22 A/D	Stem, I.D. 6
114325	22 B/D	Stem, I.D. 9
114326	22 C/D	Stem, I.D. 13
137734	22 V/D	G 1/4 IT
114327	22 K/D	Push-in plug for DN 7.2 - 7.8 couplings



22 A-S

Blow gun with chip shield (to prevent eye injuries from flyaway chip debris)

Art. No.	Type No.	Type of connection
114328	22 A-S	Stem, I.D. 6
114329	22 B-S	Stem, I.D. 9
114330	22 C-S	Stem, I.D. 13
137735	22 V-S	G 1/4 IT
114331	22 K-S	Push-in plug for DN 7.2 - 7.8 couplings

Blow guns

die-cast aluminium nickel-plated

EASY

Standard type without nozzle!

In combination with the safety nozzles described below, this blow gun meets a wide range of safety requirements.

For blowing out and cleaning machines, workpieces, bore holes, hollow parts, etc.

Material	Nickel-plated die-cast aluminium
Max. operating pressure	10 bar
Temperature range	-10 to 50 °C
Connecting thread	G 1/4
Nozzle	M12x1.25



22 A-KD



22 K-KD

Blow gun without nozzle

Art. No.	Type No.	Type of connection
114332	22 A-KD	Stem, I.D. 6
114333	22 B-KD	Stem, I.D. 9
114334	22 C-KD	Stem, I.D. 13
117444	22 K/T	G 1/4 IT
114335	22 K-KD	Push-in plug for DN 7.2 - 7.8 couplings

Extension tube (without nozzle) for use with safety nozzles standard type

Art. No.	Type No.	Description
117000	VLR150	Extension tube straight, 150 mm
117001	VLR300	Extension tube straight, 300 mm
117002	VLR450	Extension tube straight, 450 mm
117003	VLR800	Extension tube straight, 800 mm
117004	VLRG150	Extension tube bent, 150 mm
117005	VLRG300	Extension tube bent, 300 mm
117006	VLRG450	Extension tube bent, 450 mm
117007	VLRG800	Extension tube bent, 800 mm



VLR150

VLRG150

Variable-control blow guns

nickel-plated die-cast aluminium

PLUS

The blowing power is steplessly adjusted by the lever action and can be increased up to the maximum level. The blowing force can thus be individually controlled to cover a wide range of applications.

Max. operating pressure	10 bar
Working pressure	2 - 6 bar
Temperature range	-10 to 50 °C
Material	Nickel-plated die-cast aluminium
Nozzle	M12x1.25



DBPG14



DBPN72

Blow gun with standard nozzle, bore 1.5 mm

Art. No.	Type No.	Type of connection
198620	DBPG14	G 1/4 IT
202424	DBPN72	Push-in plug for DN 7.2 couplings
202425	DBPLW13	Stem, I.D. 13
202426	DBPLW9	Stem I.D. 9
202428	DBPLW6	Stem I.D. 6



Safety nozzles

for standard blow guns

If correctly designed, these noise-reducing nozzles guarantee a lower noise level than conventional one-hole types with an identical blowing force.

They are usually fitted with a noise-reducing plastic insert and they are recommended by the German BGIA (Institute for Occupational Safety and Health).



22.101 22.102



22.201 22.202-2



22.203 22.204



22.205 22.206



22.207 22.208



22.401 22.402



22.403

Low-noise fine-spray nozzle, M12x1.25 connection

Art. No.	Type No.	Material	Length mm	Nozzles-exterior Ø mm	Diagram
114354	22.101	Nickel-plated steel, brass	45.0	10	1
114355	22.102	Nickel-plated steel, brass	45.0	10	2

Low-noise round nozzle, M12x1.25 connection

Art. No.	Type No.	Material	Length mm	Nozzles-exterior Ø mm	Diagram
114356	22.201	aluminium	55.0	11	3
206348	22.202-2	Aluminium	50.0	12.5	18
114358	22.203	Aluminium	41.0	13	5
114359	22.204	Die-cast zinc	46.0	17	6
114360	22.205	Plastic (POM)	41.0	17	7
114361	22.206	Aluminium	35.0	11	8
114362	22.207	Die-cast zinc	47.0	19	9
114363	22.208	Plastic (ABS)	55.0	19	10

Low-noise flat nozzle, M12x1.25 connection

Art. No.	Type No.	Material	Length mm	Nozzle width mm	Diagram
114364	22.401	Nickel-plated brass	100.0	21.5	11
114365	22.402	Nickel-plated brass	100.0	29.0	12
114366	22.403	Nickel-plated brass	100.0	21.0	13

➔ For noise, air consumption and blowing force values, see diagrams 1-18 from page 922

Nozzles

Suitable for all aluminium and die-cast aluminium nickel-plated blow guns.



105/5



106/6



107/6

Material	Aluminium
----------	-----------

Standard nozzle with Ø 1.5 mm bore, M12x1.25 connection

Art. No.	Type No.	Nozzle type
114344	105/5	Standard (short) nozzle 1.5 mm

Silencer nozzle, M12x1.25 connection

Art. No.	Type No.	Nozzle type
114345	106/6	Silencer nozzle with sintered metal insert

Nozzle with chip shield, M12x1.25 connection

Art. No.	Type No.	Nozzle type
114346	107/6	Nozzle with chip shield

Air flow nozzle

Regulates the air flow and reduces the pressure by turning the nozzle ring.

Air flow nozzle, M12x1.25 connection		
Art. No.	Type No.	Material
114367	109/44	Aluminium / POM



109/44

Extension nozzles

For blowing out inaccessible points directly.

Extension nozzle, bore 3.0 mm, nickel-plated brass		
Art. No.	Type No.	Nozzle type
114347	22/100	100 mm long, angled
114348	22/150	150 mm long, angled
114349	22/250	250 mm long, angled
114350	23/100	100 mm long, straight
114351	23/150	150 mm long, straight
114352	23/250	250 mm long, straight
114353	23/400	400 mm long, straight



Blow guns

Plastic

EASY

For blowing out and cleaning machines, engines, bearings, sliding surfaces, bores of all kinds, hollow parts, moulds, etc.

The compressed air guns are supplied in a blister package with Euro holes.

Material	Plastic
Max. operating pressure	10 bar
Operating temperature	-20 to 45 °C

Blow gun with short nozzle		
Art. No.	Type No.	Type of connection
125657	50 D	G 1/4 female
125364	50 F	Push-in plug for DN 7.2 - 7.8 couplings



50 D

Blow gun with extension tube		
Art. No.	Type No.	Type of connection
125658	51 D	G 1/4 female
125365	51 F	Push-in plug for DN 7.2 - 7.8 couplings



51 D

Blow gun with extension tube 105 mm and collet cover		
Art. No.	Type No.	Type of connection
125503	52 D	G 1/4 female
125366	52 F	Push-in plug for DN 7.2 - 7.8 couplings



52 D

Blow gun with extension tube 105 mm and noise-reducing nozzle		
Art. No.	Type No.	Type of connection
125504	53 D	G 1/4 female
125367	53 F	Push-in plug for DN 7.2 - 7.8 couplings



53 D



NEW Blow guns

Plastic

PLUS

For blowing out and cleaning machines, motors, bearings, sliding surfaces, all types of bores, hollow bodies, moulds, etc.

Max. operating pressure	12 bar
Operating temperature	-10 to 90 °C
Gun body	Polypropylene (PP)
Nozzle	M12x1.25



BPKRDUAG14

Blow gun without nozzle, connectable below

Art. No.	Type No.	Type of connection
129360	BPKRODUAG14	G 1/4 IT
129361	BPKRODUANW72	Push-in plug DN 7.2
129362	BPKRODUALW6	Stem, I.D. 6
129363	BPKRODUALW9	Stem, I.D. 9
129364	BPKRODUALW13	Stem, I.D. 13

Blow gun without nozzle, connectable on top

Art. No.	Type No.	Type of connection
129365	BPKRODOAG14	G 1/4 IT
129366	BPKRODOANW72	Push-in plug DN 7.2
129367	BPKRODOALW6	Stem, I.D. 6
129368	BPKRODOALW9	Stem, I.D. 9
129369	BPKRODOALW13	Stem, I.D. 13

Blow gun with standard nozzle, connectable below

Art. No.	Type No.	Type of connection
129370	BPKRDUAG14	G 1/4 IT
129371	BPKRDUANW72	Push-in plug DN 7.2
129372	BPKRDUALW6	Stem, I.D. 6
129373	BPKRDUALW9	Stem, I.D. 9
129374	BPKRDUALW13	Stem, I.D. 13

Blow gun with standard nozzle, connectable on top

Art. No.	Type No.	Type of connection
129375	BPKRDOAG14	G 1/4 IT
129376	BPKRDOANW72	Push-in plug DN 7.2
129377	BPKRDOALW6	Stem, I.D. 6
129378	BPKRDOALW9	Stem, I.D. 9
129379	BPKRDOALW13	Stem, I.D. 13

Blow gun with rod nozzle, connectable below

Art. No.	Type No.	Type of connection
129380	BPKRSDUAG14	G 1/4 IT
129381	BPKRSDUANW72	Push-in plug DN 7.2
129382	BPKRSDUALW6	Stem, I.D. 6
129383	BPKRSDUALW9	Stem, I.D. 9
129384	BPKRSDUALW13	Stem, I.D. 13

Blow gun with rod nozzle, connectable on top

Art. No.	Type No.	Type of connection
129385	BPKRSDOAG14	G 1/4 IT
129386	BPKRSDOANW72	Push-in plug DN 7.2
129387	BPKRSDOALW6	Stem, I.D. 6
129388	BPKRSDOALW9	Stem, I.D. 9
129389	BPKRSDOALW13	Stem, I.D. 13

NEW Blow guns

Plastic

PLUS

Blow gun with safety nozzle, connectable below

Art. No.	Type No.	Type of connection
129390	BPKRSHDUAG14	G 1/4 IT
129391	BPKRSHDUANW72	Push-in plug DN 7.2
129392	BPKRSHDUALW6	Stem, I.D. 6
129393	BPKRSHDUALW9	Stem, I.D. 9
129394	BPKRSHDUALW13	Stem, I.D. 13



BPKRDUAG14

Blow gun with safety nozzle, connectable on top

Art. No.	Type No.	Type of connection
129395	BPKRSHDOAG14	G 1/4 IT
129396	BPKRSHDOANW72	Push-in plug DN 7.2
129397	BPKRSHDOALW6	Stem, I.D. 6
129398	BPKRSHDOALW9	Stem, I.D. 9
129399	BPKRSHDOALW13	Stem, I.D. 13

Variable-control blow guns

plastic

PLUS

With noise-reducing Star-Tip nozzle.

Ergonomic grip with a very high blowing force. Several possible hanging points thanks to the modified handle. Robust yet lightweight for a long service life. With its ergonomic design, the gun can be used by both left and right-handed users!

Material	POM
Tube	Nickel-plated brass
Connecting thread	Rc 1/4
Max. operating pressure	16 bar
Temperature range	-20 to 60 °C

Blow gun, stepless adjustment, for use with extension tubes, without nozzle

Art. No.	Type No.	Type of connection
114390	36 A	Stem, I.D. 6
114391	36 B	Stem, I.D. 9
114392	36 C	Stem, I.D. 13
118433	36 K/T	Rc 1/4 IT
114393	36 K	Push-in plug for DN 7.2 - 7.8 couplings



36 K

Blow gun, stepless adjustment, 90 mm tube

Art. No.	Type No.	Type of connection
114394	37 A	Stem, I.D. 6
114395	37 B	Stem, I.D. 9
114396	37 C	Stem, I.D. 13
118465	37 V	Rc 1/4 IT
114397	37 K	Push-in plug for DN 7.2 - 7.8 couplings



37 V

Blow gun, stepless adjustment, with noise-reducing nozzle, 90 mm tube

Art. No.	Type No.	Type of connection
114398	38 A	Stem, I.D. 6
114399	38 B	Stem, I.D. 9
114400	38 C	Stem, I.D. 13
118485	38 V	Rc 1/4 IT
114401	38 K	Push-in plug for DN 7.2 - 7.8 couplings



38 A



Variable-control blow guns

plastic



37.090



37.400



37.300



38.090



38.300

Extension tube for basis blow guns

Art. No.	Type No.	Description
114402	37.090	Blow pipe with standard nozzle, 90 mm, bent
114403	37.300	Extension tube with standard nozzle, 300 mm, straight
114404	37.500	Extension tube with standard nozzle, 500 mm, straight
114405	37.400	Flexible extension tube standard nozzle, 400 mm, bendable
114406	38.090	Blow pipe with Star-Tip nozzle, 90 mm, bent
114407	38.300	Extension tube with Star-Tip nozzle, 300 mm straight
114408	38.500	Extension tube with Star-Tip nozzle, 500 mm straight



40 A



40 V

Blow guns with pressure regulator

plastic

PLUS

Pressure regulating safety version.

Ergonomic grip with a very high blowing force. Several possible hanging points thanks to the modified handle. Robust yet lightweight for a long service life. With its ergonomic design, the gun can be used by both left and right-handed users! The integrated tube regulator reduces the output pressure to a safe value in the event of blockage inside the tube or in case of back pressure (e.g. if the gun is placed on a surface or on the operator's skin).

Material	POM
Tube	Nickel-plated brass
Connecting thread	Rc 1/4
Max. operating pressure	8 bar
Temperature range	-20 to 60 °C

Blow gun, stepless adjustment, with pressure regulator, 90 mm tube

Art. No.	Type No.	Type of connection
114409	40 A	Stem, I.D. 6
114410	40 B	Stem, I.D. 9
114411	40 C	Stem, I.D. 13
118582	40 V	Rc 1/4 IT
114412	40 K	Push-in plug for DN 7.2 - 7.8 couplings



378.01

378.01-14

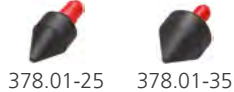

378.01-25

378.01-35

Accessories for plastic blow guns

Art. No.	Type No.	Description
114413	378.01	Rubber nozzle set (Ø 14, 25, 35 mm) to plug onto the pipe
135938	378.01-14	Rubber nozzle Ø 14 mm to plug onto the pipe
135939	378.01-25	Rubber nozzle Ø 25 mm to plug onto the pipe
135940	378.01-35	Rubber nozzle Ø 35 mm to plug onto the pipe
114414	378.02	Chip shield, fits directly onto the tube
114415	378.03	Silencer nozzle, fits directly onto the tube
114416	378.04	Venturi nozzle for deflecting lightweight chips
114417	378.05	Bypass nozzle fit directly onto the tube
114418	378.06	Air curtain nozzle fit directly onto the tube
114419	378.07	Silencer nozzle for reducing noise



378.02

378.03

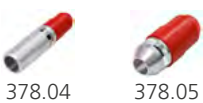

378.04

378.05

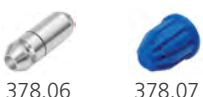

378.06

378.07

Blow gun holder

Suitable for all aluminium and plastic blow guns (exception: »Typhoon« blow guns).

Blow gun holder		
Art. No.	Type No.	Description
142249	BPH-1	Blow gun holder, incl. 2 brackets



BPH-1



Blow-off valves

aluminium, straight type

PLUS ||

Robust, ergonomic blow-off valve for continuous duty under extreme conditions.

Max. operating pressure	12 bar
Temperature range	-20 to 100 °C
Nozzle	G 3/8

Blow-off valve, aluminium, with standard nozzle		
Art. No.	Type No.	Type of connection
114424	21 A	Stem, I.D. 6
114425	21 B	Stem, I.D. 9
114426	21 C	Stem, I.D. 13
114427	21 K	Push-in plug for DN 7.2 coupling
114428	21-0	thread G 1/4 IT



21 K



High-volume blow guns

»Typhoon« type

MAX

Steplessly adjustable, lightweight and ergonomically optimised high-volume blow gun with exceptionally high blowing power.

The »Typhoon« model, which achieves approximately three times the blowing power of conventional guns, rests comfortably and securely in the hand even when full pressure is applied. Extension tubes can be supplied for blowing out inaccessible points.

In combination with safety nozzles, this blow gun meets a wide range of safety requirements.

Material	Aluminium
Hand lever	Die cast aluminium
Max. operating pressure	10 bar
Connecting thread	G 1/4
Nozzle	1/2" - 27 UNS



29 K

High-volume blow gun with standard nozzle

Art. No.	Type No.	Type of connection
114429	29 A	Stem, I.D. 6
114430	29 B	Stem, I.D. 9
114431	29 C	Stem, I.D. 13
118124	29 V	G 1/4 IT
114432	29 K	Push-in plug for DN 7.2 coupling



29 V-MJ

High-volume blow gun with multijet nozzle

Art. No.	Type No.	Type of connection
133838	29 A-MJ	Stem, I.D. 6
133839	29 B-MJ	Stem, I.D. 9
133840	29 C-MJ	Stem, I.D. 13
135937	29 V-MJ	G 1/4 IT
133841	29 K-MJ	Push-in plug for DN 7.2 coupling



29 A-KD

High-volume blow gun, without nozzle

Art. No.	Type No.	Type of connection
114442	29 A-KD	Stem, I.D. 6
114443	29 B-KD	Stem, I.D. 9
114444	29 C-KD	Stem, I.D. 13
137644	29 V-KD	G 1/4 IT
114445	29 K-KD	Push-in plug for DN 7.2 - 7.8 couplings

High-volume blow guns

»Typhoon pro« type

MAX

Steplessly adjustable and ergonomically optimised high-volume blow gun in full metal housing with exceptionally high blowing power. The »Typhoon pro« model, which achieves approximately three times the blowing power of conventional guns, rests comfortably and securely in the hand even when full pressure is applied. Resistant to chemicals and chemical solvents, with a chrome-plated surface for easy cleaning!

Material	Chrome-plated aluminium
Hand lever	Die-cast zinc
Max. operating pressure	10 bar
Connecting thread	G 1/4
Nozzle	1/2" - 27 UNS chrome-plated brass

High-volume blow gun »Typhoon pro«

Art. No.	Type No.	Type of connection
114464	39 A	Stem, I.D. 6
114465	39 B	Stem, I.D. 9
114466	39 C	Stem, I.D. 13
118492	39 V	G 1/4 IT
114467	39 K	Push-in plug for DN 7.2 couplings



39 A



39 V

Accessories for Typhoon blow guns

Nozzle

Art. No.	Type No.	Description
114435	29.550	Standard nozzle, 1/2 - 27 UNS male
114436	29.551	Nozzle for extension pipe, 1/2 - 27 UNS female
133848	29.552	Multijet nozzle, Exterior thread 1/2 - 27 UNS
114437	29.560	Adapter for needle valve nozzles and rubber nozzles
114438	29.562	Needle Nozzle outer-Ø 1,27 mm, 30 mm, adapter required
114439	29.563	Needle Nozzle outer-Ø 1,87 mm, 44 mm, adapter required
114440	29.564	Needle Nozzle outer-Ø 2,43 mm, 62 mm, adapter required
114441	29.565	Needle Nozzle outer-Ø 3,40 mm, 70 mm, adapter required
133849	29.566	Rubber tapered nozzle, adapter required
133850	29.567	Rubber bypass nozzle, adapter required



29.550



29.551



29.552



29.560



29.562



29.566



29.567

Extension pipe with standard nozzle

Art. No.	Type No.	Description
133842	29.150	Extension pipe 150 mm with standard nozzle
114433	29.300	Extension pipe 300 mm with standard nozzle
114434	29.600	Extension pipe 600 mm with standard nozzle
133843	29.900	Extension pipe 900 mm with standard nozzle



29.300

Extension pipe with multijet nozzle

Art. No.	Type No.	Description
133844	29.150-MJ	Extension pipe 150 mm with multijet nozzle
133845	29.300-MJ	Extension pipe 300 mm with multijet nozzle
133846	29.600-MJ	Extension pipe 600 mm with multijet nozzle
133847	29.900-MJ	Extension pipe 900 mm with multijet nozzle



29.900



29.300-MJ



29.900-MJ



Accessories for Typhoon blow guns



Extension pipe without nozzle for use with safety nozzles, 1/2-27 UNS connection

Art. No.	Type No.	Description	Material
114447	29.150-S	Extension tube straight, 150 mm	Aluminium
114448	29.300-S	Extension tube straight, 300 mm	Aluminium
114449	29.600-S	Extension tube straight, 600 mm	Aluminium
114450	29.900-S	Extension tube straight, 900 mm	Aluminium
114451	29.150-SG	Extension tube bent, 150 mm	Aluminium
114452	29.300-SG	Extension tube bent, 300 mm	Aluminium
114453	29.600-SG	Extension tube bent, 600 mm	Aluminium
114454	29.900-SG	Extension tube bent, 900 mm	Aluminium

→ The accessories are not suitable for the high-performance blow guns type »Typhoon Plus«

NEW High-volume blow guns

»Typhoon Plus« type

MAX

Steplessly adjustable, lightweight and ergonomically optimised high-volume blow gun with exceptionally high blowing power.

Compared to conventional blow guns the flow rate of the »Typhoon Plus« type can be flexibly adjusted by rotary wheel.

Material	Plastic
Max. operating pressure	10 bar
Nozzle	1/2" – 27 UNS



BPKTG14

High-volume blow gun »Typhoon Plus«

Art. No.	Type No.	Type of connection
205798	BPKTLW6	Stem, I.D. 6
205799	BPKTLW9	Stem, I.D. 9
205800	BPKTLW13	Stem, I.D.13
103244	BPKTG14	G 1/4 IT
205801	BPKTNW72	Push-in plug for DN 7.2 coupling



BPKTNW72



Safety nozzles

for high-volume blow guns

If correctly designed, these noise-reducing nozzles guarantee a lower noise level than conventional one-hole types with an identical blowing force.

They are usually fitted with a noise-reducing plastic insert and they are recommended by the German BGIA (Institute for Occupational Safety and Health).



Low-noise fine-spray nozzle, 1/2 - 27 UNS connection

Art. No.	Type No.	Material	Length mm	Nozzles-exterior Ø mm	Diagram
114455	29.101	Nickel-plated steel, brass	45.0	10	1
114456	29.102	Nickel-plated steel, brass	45.0	10	2

Low-noise round nozzle, 1/2 - 27 UNS connection

Art. No.	Type No.	Material	Length mm	Nozzles-exterior Ø mm	Diagram
114457	29.201	aluminium	55.0	11	3
114458	29.202	Aluminium	50.0	10	4
114459	29.203	Aluminium	41.0	13	5
114460	29.206	Aluminium	35.0	11	8

Low-noise flat nozzle, 1/2 - 27 UNS connection

Art. No.	Type No.	Material	Length mm	Nozzle width mm	Diagram
114461	29.401	Nickel-plated brass	100.0	21.5	11
114462	29.402	Nickel-plated brass	100.0	29.0	12
114463	29.403	Nickel-plated brass	100.0	21.0	13

→ For noise, air consumption and blowing force values, see diagrams 1-18 from page 922

Screw adapter for blow guns

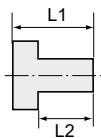

Thread adapter for the use of safety nozzles with connection M12x1.25 blow gun »Typhoon« type

Art. No.	Type No.	Male thread	Female thread	L1 mm	L2 mm	a/f mm
114446	29.22	1/2" - 27 UNS	M12x1.25	25.0	9.0	17

Thread adapter for the adaptation of safety nozzles G 1/4 on the blow gun »Typhoon« type and aluminium blow gun

Art. No.	Type No.	Male thread	Female thread	L1 mm	L2 mm	a/f mm
133177	29.14	1/2" - 27 UNS	G 1/4	25.0	9.0	17
133178	22.14	M12x1.25	G 1/4	26.0	10.0	

Safety nozzles

for universal applications

If correctly designed, these noise-reducing nozzles guarantee a lower noise level than conventional one-hole types with an identical blowing force.

They are usually fitted with a noise-reducing plastic insert and they are recommended by the German BGIA (Institute for Occupational Safety and Health).

Low-noise fine-spray nozzle

Art. No.	Type No.	Thread	Material	Length mm	Nozzles-exterior Ø mm	Diagram
114468	30.101	G 1/4 ET	Nickel-plated steel, brass	45.0	10	1
114469	30.102	G 1/4 ET	Nickel-plated steel, brass	45.0	10	2



Low-noise round nozzle

Art. No.	Type No.	Thread	Material	Length mm	Nozzles-exterior Ø mm	Diagram
114470	30.201	G 3/8 ET	Nickel-plated brass	55.0	11	3
114471	30.202	G 3/8 ET	Aluminium	50.0	10	4
114472	30.203	G 1/4 ET	Aluminium	41.0	13	5
114473	30.204	G 1/4 ET	Die-cast zinc	46.0	17	6
114474	30.205	G 1/4 ET	Plastic (POM)	40.0	17	7
114475	30.206	G 1/4 ET	Aluminium	35.0	11	8
114476	30.207	G 1/4 ET	Die-cast zinc	47.0	19	9
114477	30.208	G 1/4 ET	Plastic (ABS)	55.0	19	10



Low-noise flat nozzle

Art. No.	Type No.	Thread	Material	Length mm	Nozzle width mm	Diagram
114478	30.401	G 1/4 ET	Nickel-plated brass	100.0	21.5	11
114479	30.402	G 3/8 ET	Nickel-plated brass	100.0	29.0	12
114480	30.403	G 3/8 ET	Galvanised steel	50.0	16.5	14
114481	30.404	G 1/4 ET	Nickel-plated brass	100.0	21.0	13
114482	30.405	G 3/8 ET	Nickel-plated brass	100.0	29.0	15



→ For noise, air consumption and blowing force values, see diagrams 1-18 from page 922



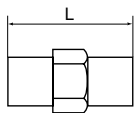

Mini pressure regulators



This preset pressure regulator guarantees optimal pressure conditions, especially in blow guns. The pressure regulator is inserted into the compressed air line. Fits onto any 1/4" thread and maintains the pressure at optimum, thus helping to reduce the costs for energy. Tamper-proof.

Max. input pressure	12 bar
Temperature range	-20 to 60 °C
Housing	Brass
Spring	Stainless steel
Flow rate	0 - 400 l/min



638.42

Mini pressure regulator

Art. No.	Type No.	Thread	Working pressure (preset) bar	L mm
101506	638.42	G 1/4 ET/ET	2	24.0
101507	638.44	G 1/4 ET/ET	4	24.0
101508	638.46	G 1/4 ET/ET	6	24.0

NEW Spray gun



With plastic cup, capacity approx. 1.0 litres, matte red.

The spray fan of these guns can be adjusted with a nozzle according to requirements: Simply loosen the lock nut - adjust the nozzle - re-tighten the nut.

Max. operating pressure	12 bar
Operating temperature	-10 to 90 °C
Working pressure	2 - 8 bar
Material	Aluminium nickel plated
Hand lever	nickel-plated steel
Nozzle	Ø 4.5 mm
Applications	Cleaning agents, fungicides in the agricultural sector



SPR1L



SPR1LB

Spray gun

Art. No.	Type No.	Type of connection	Description
100307	SPR1L	Push-in plug for DN 7.2 coupling	Spray gun with straight spray pipe

Spare parts for spray guns

Art. No.	Type No.	Description
103243	SPR1LB	Plastic cup, capacity 1.0 litres, matt red

Spray gun

the easy way to spray solvents or other liquids



Plastic gun with a lightweight yet robust plastic container. The gun rests in a cradle and can easily be removed or replaced. Suitable for solvents! The spray fan can be adjusted with a throttle.

Connection	With coupler plug (for standard DN 7.2 couplings)
------------	---

Spray gun, plastic		
Art. No.	Type No.	Description
114485	14 B/E	Spray guns



14 B/E

Professional industrial spray gun



Ideal for cleaning in industry and manual trades. The thick rubber coating provides thermal insulation for the hot or cold water flowing inside as well as impact protection. The flow rate is controllable with the adjustment screw (using a coin). The steel shackle allows the lever to be latched for extended use. Also suitable for drinking water.

Max. operating pressure	24 bar
Max. operating temperature	50 °C
Flow rate	25 l/min (at 5 bar)
Housing	Brass
Valve insert	chromium steel
Material	rubber coating EPDM

Professional industrial spray gun		
Art. No.	Type No.	Type of connection
114493	RP-1	G 1/2 female



RP-1



Handheld tyre gauge in pistol shape

EASY



35.063

Hose connection G 1/4, swivelling

Handheld tyre gauges with pressure gauge 63 mm Ø, uncalibrated

Art. No.	Type No.	Description	Measuring range bar	Measuring range psi
114527	35.061	with car-valve lever plug	0 to 10	0 - 140
114528	35.062	with double filling-station plug	0 to 10	0 - 140
114529	35.063	with clip-on connector	0 to 10	0 - 140



36.020

37.030



38.230

36.42



36.030

37.250

Accessoires for handheld tyre gauge in pistol shape

Art. No.	Type No.	Description
114531	36.020	Clip-on connector
114532	37.030	Twin hold-on connector
114533	36.230	Hose, complete with tyre valve connector
114539	36.38	Pressure gauge 0 - 10 bar/140 psi 63 mm Ø, G 1/4 rear
114530	36.030	Tyre valve connector
114535	37.230	Hose, complete with twin hold-on connector
114537	38.230	Hose, complete with clip-on connector

Handheld tyre gauge in pistol shape

Standard type

EASY



39.013

Hose connection G 1/4, rigid

Standard type handheld tyre gauge in pistol shape, hose rigid

Art. No.	Type No.	Description	Pressure gauge Ø mm	Measuring range bar	Measuring range psi
118500	39.013	Uncalibrated, with quick connector	63	0 to 12	0 - 170
117141 NEW	39.013GE	Calibrated, with quick connector	63	0 to 10	0 - 140
136785	39.014	Uncalibrated, with tyre valve connector	63	0 to 12	0 - 170
117142 NEW	39.014GE	Calibrated, with tyre valve connector	63	0 to 10	0 - 140
136788	39.015	Uncalibrated, with garage connector	63	0 to 12	0 - 170
117143 NEW	39.015GE	Calibrated, with garage connector	63	0 to 10	0 - 140



39.014GE



39.015GE

Accessoires for standard type handheld tyre gauge in pistol shape

Art. No.	Type No.	Description
136789	39.501	Clip-on connector
136792	39.601	Hose with quick connector, Length 75 cm, G 1/4 swivelling
136798	39.704	Cap for pressure gauge Ø 63 mm, Connection bottom
136797	39.703	Pressure gauge Ø 63 mm, Uncalibrated, Connection bottom
136796	39.702	Pressure gauge Ø 63 mm, Uncalibrated, Connection rear
136790	39.502	Tyre valve connector
136793	39.602	Hose, tyre valve connector, Length 75 cm, G 1/4 swivelling
136791	39.503	Twin hold-on connector
136794	39.603	Hose with garage connector, Length 75 cm, G 1/4 swivelling

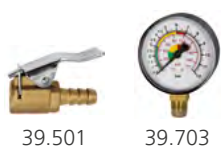

39.501

39.703

Handheld tyre gauges

Standard type

PLUS

Robust, standard handheld tyre gauge with rubber sheath and pressure gauge with dual scale in bar / psi. Hose length 50 cm. With push-in plug, brass, for 7.2 - 7.8 mm coupling.



Standard type handheld tyre gauge with clip connector, hose rigid

Art. No.	Type No.	Description	Pressure gauge Ø mm	Hose connection	Measuring range bar	Measuring range psi
114543	39.011	Uncalibrated	63	G 1/4, rigid	0 to 12	0 - 170



Standard type handheld tyre gauge with clip connector, hose swivelling

Art. No.	Type No.	Description	Pressure gauge Ø mm	Hose connection	Measuring range bar	Measuring range psi
136799	39.021	Calibrated	80	G 1/4, swivelling	0 to 12	0 - 170
136800	39.022	Uncalibrated	80	G 1/4, swivelling	0 to 12	0 - 170



Standard type handheld tyre gauge with tyre valve connector, hose swivelling

Art. No.	Type No.	Description	Pressure gauge Ø mm	Hose connection	Measuring range bar	Measuring range psi
136783	39.031	Calibrated	80	G 1/4, swivelling	0 to 12	0 - 170
136784	39.032	Uncalibrated	80	G 1/4, swivelling	0 to 12	0 - 170



Standard type handheld tyre gauge with hold-on connector, hose swivelling

Art. No.	Type No.	Description	Pressure gauge Ø mm	Hose connection	Measuring range bar	Measuring range psi
136786	39.041	Calibrated	80	G 1/4, swivelling	0 to 12	0 - 170
136787	39.042	Uncalibrated	80	G 1/4, swivelling	0 to 12	0 - 170

Accessoires for tyre gauges standard type

Art. No.	Type No.	Description
136789	39.501	Clip-on connector
136792	39.601	Hose with quick connector, Length 75 cm, G 1/4 swivelling
136795	39.701	Pressure gauge Ø 80 mm, Uncalibrated, Connection rear
136790	39.502	Tyre valve connector
136793	39.602	Hose, tyre valve connector, Length 75 cm, G 1/4 swivelling
136791	39.503	Twin hold-on connector
136794	39.603	Hose with garage connector, Length 75 cm, G 1/4 swivelling

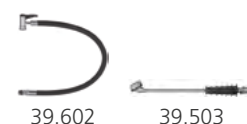



39.023D



39.033D



39.043D

NEW Digital handheld tyre gauge

PLUS

Hose connection G 1/4, swivelling

Digital handheld tyre gauge, hose swivelling

Art. No.	Type No.	Description	Pressure gauge Ø mm	Measuring range bar	Measuring range psi
116963	39.023D	Uncalibrated, with quick connector	80	0 to 12	0 - 175
116964	39.033D	Uncalibrated, with tyre valve connector	80	0 to 12	0 - 175
116965	39.043D	Uncalibrated, with garage connector	80	0 to 12	0 - 175



39.501



39.601



39.502



39.602



39.503



39.603

Accessories for digital handheld tyre gauge

Art. No.	Type No.	Description
136789	39.501	Clip-on connector
136792	39.601	Hose with quick connector, Length 75 cm, G 1/4 swivelling
136790	39.502	Tyre valve connector
136793	39.602	Hose, tyre valve connector, Length 75 cm, G 1/4 swivelling
136791	39.503	Twin hold-on connector
136794	39.603	Hose with garage connector, Length 75 cm, G 1/4 swivelling

Tyre gauges

MAX

These pressure gauges are effectively protected against shock and impact by means of a free-standing plastic cap. They can be loaded against gauge pressure and up to the maximum scale value. With push-in plug for DN 7.2 coupling.

Since 2021 all variants are only sold conformity assessed according to module D.
Type examination certificate: Directive according to module B: DE-19-M-PTB-0053.



36.013



37.013



34.014

Handheld tyre gauge with tyre valve connector

Art. No.	Type No.	Measuring range bar	Measuring range psi	Description
205568	36.013.2	0 to 12	0 - 170	conformity assessed
114518	36.015	0 to 25	0 - 350	not conformity assessed

Handheld tyre gauge with twin hold-on connector

Art. No.	Type No.	Measuring range bar	Measuring range psi	Description
205569	37.013.2	0 to 12	0 - 170	conformity assessed
114521	37.015	0 to 25	0 - 350	not conformity assessed

Handheld tyre gauge with clip-on connector

Art. No.	Type No.	Measuring range bar	Measuring range psi	Description
205570	34.013.2	0 to 12	0 - 170	conformity assessed

Accessoires

Art. No.	Type No.	Description
114530	36.030	Tyre valve connector
114534	36.250	Hose, tyre valve connector, Length 75 cm, G 1/4 swivelling
114541	36.42	Pressure gauge 0 - 12 bar/170 psi 80 mm Ø, for plugging
114542	36.43	Pressure gauge 0 - 25 bar/350 psi 80 mm Ø, for plugging
114532	37.030	Twin hold-on connector
114536	37.250	Hose with garage connector, Length 75 cm, G 1/4 swivelling
114531	36.020	Clip-on connector
114538	38.250	Hose with quick connector, Length 75 cm, G 1/4 swivelling



36.030



36.250



36.42



37.030



37.250



36.020



38.230



Industrial adhesives

Chemical products for industrial applications.

Anaerobically curing liquid plastics for locking, fastening and sealing. Suitable for use with metals. Passive surfaces (zinc, chromium, nickel, stainless steel, plastic, glass) must be pre-treated with Lock Activator F.



Lock AN 301-43

Screw locking, medium strength, non-classified and DVGW certified

Non-classified adhesive for sensitive production areas

- Very good strength
- Good chemical resistance after curing
- High level of safety and health at work
- No irritation to eyes, nose or throat
- No marking with hazard symbols in accordance with EC Regulation No. 1907/2006 - ISO 11014-1



3014/50

Thermally stable	-60 to 150 °C
Applications	Screw locking
Strength	Medium strength
Viscosity	Higher viscosity

Lock AN 301-43

Art. No.	Type No.	Description
114545	3014/50	Container 50 ml

Lock AN 302-21

Screw locking, low strength

Vibration-proof, threadlocking for all threads up to M12, easy disassembly.



3023/50

Thermally stable	-60 to 150 °C
Applications	Screw locking
Strength	low strength
Viscosity	low viscosity

Lock AN 302-21

Art. No.	Type No.	Description
114551	3023/50	Container 50 ml

Lock AN 302-43

Screw locking, medium strength, DVGW certified

The standard adhesive for locking all screws and threads up to size M36.
For economical securing, fastening, sealing of screw, joint and surface connections.
Simple, fast and economical in use, hand-tight within minutes, hardens in a few hours.
High-temperature resistant. Disassembled normally.



Thermally stable	-60 to 200 °C
Applications	Screw locking
Strength	medium strength
Viscosity	higher viscosity

Lock AN 302-43

Art. No.	Type No.	Description
114553	3024/10	Container 10 ml
114554	3024/50	Container 50 ml
114555	3024/250	Container 250 ml



3024/250

Lock AN 302-60

Screw locking for passive materials, high strength

High-strength bonding of passive materials such as stainless steel or aluminium, no pre-treatment required

- Reduced assembly time
- High strength
- Handling strength: just 2 to 5 minutes
- Final strength: just 2 to 4 hours
- No need for pre-treatment with activator and therefore no additional emissions due to solvents

Thermally stable	-60 to 180 °C
Applications	Screw locking without pretreatment
Strength	High strength
Viscosity	Medium viscosity

Lock AN 302-60

Art. No.	Type No.	Description
114556	3026/50	Container 50 ml



3026/50

Lock AN 302-70

Screw locking, high strength

For locking all screws and stud bolts up to size M20/R 3/4", difficult to separate.

Thermally stable	-60 to 150 °C
Applications	Screw locking
Strength	High strength
Viscosity	Medium viscosity

Lock AN 302-70

Art. No.	Type No.	Description
114558	3027/50	Container 50 ml



3027/50





Lock AN 301-72

Tube and surface seal with PTFE, medium strength, non-classified and DVGW certified

Non-classified adhesive for sensitive production areas

- Very good strength
- Resistant to high temperatures
- Good chemical resistance after curing
- High level of safety and health at work
- No irritation to eyes, nose or throat
- No marking with hazard symbols in accordance with EC Regulation No. 1907/2006 - ISO 11014-1



3018/50

Thermally stable	-60 to 200 °C
Applications	Tube and surface seal with PTFE
Strength	Medium strength
Viscosity	High viscosity

Lock AN 301-72

Art. No.	Type No.	Description
114549	3018/50	Container 50 ml



Lock AN 305-77

Pipe and thread seal, medium strength, DVGW certified

Sealing type for pipes and fittings, suitable for all threads up to M80/R3".
Difficult to separate.



3030/50

Thermally stable	-60 to 150 °C
Applications	Sealing type for pipes and fittings
Strength	Medium strength
Viscosity	High viscosity

Lock AN 305-77

Art. No.	Type No.	Description
114559	3030/50	Container 50 ml



Lock AN 306-20

Retaining cylindrical assemblies, high strength, DVGW certified

Retaining cylindrical assemblies for all threads up to size M56/R 2".
Resistant to high temperatures, difficult to separate.



3044/250

Thermally stable	-60 to 200 °C
Applications	Retaining cylindrical assemblies
Strength	High strength
Viscosity	Higher viscosity

Lock AN 306-20

Art. No.	Type No.	Description
114563	3044/50	Container 50 ml
114564	3044/250	Container 250 ml

Lock Aktivator F

Activates passive surfaces and accelerates the curing process.
Enables Lock adhesives to be used for metal-to-plastic bonds or at low temperatures.

Lock Aktivator F		
Art. No.	Type No.	Description
114565	3150/200	Lock Aktivator F, 200 ml



Versand in die Schweiz nicht möglich!

3150/200

Technical sprays

All-Round Spray

with PTFE

All-round spray containing PTFE for use in all industrial or workshop applications. Corrosion protection, cleaning, water displacement, lubrication and conservation in a single product! Separates seized screw fittings, bolts, etc., prevents leakage currents, cleans dirty surfaces, protects and cares for all tools, machines and precision instruments to prolong their service life.

All-Round Spray		
Art. No.	Type No.	Description
114566	3270/400	All-Round Spray, 400 ml



Versand in die Schweiz nicht möglich!

3270/400

NEW All-Round Spray

without PTFE

All-round spray without PTFE for use in all industrial or workshop applications. Corrosion protection, cleaning, water displacement, lubrication and conservation in a single product! Separates seized screw fittings, bolts, etc., prevents leakage currents, cleans dirty surfaces, protects and cares for all tools, machines and precision instruments to prolong their service life.

All-Round Spray		
Art. No.	Type No.	Description
117154	SPD400ALL	Allroundspray, ohne PTFE, 400 ml
117155	SPD500ALLMD	All-round spray with multi nozzle, without PTFE, 500 ml



SPD500ALLMD





3280/400

Stainless steel care spray

Cleaning, care and protection of matte and polished stainless steel surfaces indoors and outdoors. Antistatic effect, colourless, prevents dirt from sticking to surfaces again.

Thermally stable -17 to 120 °C

Stainless steel care spray

Art. No.	Type No.	Description
114567	3280/400	Stainless steel care spray, 400 ml



3210/400

Bio-Cut

Biologically degradable, heavy-duty cutting oil. Unusually good cutting action permits higher cutting speeds and a longer life. The service life of the cutting tools is likewise prolonged.

Bio-Cut

Art. No.	Type No.	Description
114568	3210/400	Bio-Cut, 400 ml



3180/400

Sealant and Adhesive Remover

Removes stubborn sealant and adhesive residues as well as a wide range of paints and varnishes.

Free of dichloromethane

RIEGLER Sealant and Adhesive Remover

Art. No.	Type No.	Description
114569	3180/400	Sealant and Adhesive Remover, 400 ml



3200/400

Leak Detection Spray

Detects cracks and porous areas in compressed air pipes quickly, conveniently and reliably. Non-flammable, anti-corrosive action. DVGW tested.

Leak Detection Spray

Art. No.	Type No.	Description
114570	3200/400	Leak Detection Spray, 400 ml

Rust Loosener and Contact Spray

6-fold action: Removes rust - displaces and creeps under water - improves contact-making - protects against corrosion - lubricates sliding surfaces - cares for metal.

Rust Loosener and Contact Spray

Art. No.	Type No.	Description
114571	3170/400	Rust Loosener and Contact Spray, 400 ml



Versand in die Schweiz nicht möglich

3170/400

Rust Shock

The chemical spanner. Separates screw fittings of all kinds - no matter how problematic - in seconds with its cold-shrinkage and capillary action. Contains no mineral oil, silicone or grease.

Rust Shock

Art. No.	Type No.	Description
114572	3190/400	Rust Shock, 400 ml



Versand in die Schweiz nicht möglich

3190/400

Hand protective foam

RIEGLER hand protective foam forms a greaseless, invisible and water-resistant film that prevents various kinds of soiling from penetrating the skin and pores. Protects against harmful and irritant ingredients in aggressive chemical substances. The care effect is considerably improved due to the addition of liposomes.

Hand protective foam

Art. No.	Type No.	Description
114573	3130/200	Hand protective foam, 200 ml



Versand in die Schweiz nicht möglich

3130/200

Silicon-Spray

Ideal lubricant and separating agent for rational production and servicing. Protection and care product for plastic, rubber and metal.

Thermally stable	-50 to 250 °C
------------------	---------------

Silicon-Spray

Art. No.	Type No.	Description
114574	3140/400	Silicon-Spray, 400 ml



Versand in die Schweiz nicht möglich

3140/400





Versand in die Schweiz nicht möglich!

3160/500

Cleaner Spray S

Cleaner and degreaser, suitable for many surfaces (metals, glass, ceramics and many plastics). Should always be used before applying Lock products.

Cleaner Spray S

Art. No.	Type No.	Description
114575	3160/500	Cleaner Spray S, 500 ml

Surface and corrosion inhibiting sprays

High-quality sprays for treating or repairing metal surfaces and preventing corrosion and rust. The sprays are dust-dry after 10 to 15 minutes and after a maximum of 12 hours are fully hardened and can be painted over.

Aluminium spray

High-quality corrosion protection for all metal surfaces, non-abrasive. Resistant to a large number of diluted acids and alkaline solutions, weatherproof. Suitable for use in air conditioning and ventilation systems, combustion plants, pipelines and machine housings.

Thermally stable max. 800 °C

Aluminium spray

Art. No.	Type No.	Description
114577	3230/400	Aluminium spray, 400 ml



Versand in die Schweiz nicht möglich!

3230/400

Stainless steel spray

Provides all metal surfaces with permanent protection against rust and corrosion. This spray can be used to repair damaged stainless steel parts. It forms a quick-drying, adhesive, protective layer and is resistant to a large number of chemicals.

Thermally stable max. 300 °C

Stainless steel spray

Art. No.	Type No.	Description
114578	3240/400	Stainless steel spray, 400 ml



Versand in die Schweiz nicht möglich!

3240/400

Copper spray

Weatherproof sprays for protective or decorative metal coatings.

Thermally stable max. 300 °C

Copper spray

Art. No.	Type No.	Description
114580	3260/400	Copper spray, 400 ml



3260/400

Zinc spray

Provides all metal surfaces with permanent, cathodic corrosion protection. Resistant protective layer against weather and environmental influences. This spray can be used to repair damaged galvanised parts, as high-quality rust protection primer or for touching up welded or drilled sections. It meets all the requirements of DIN 53167 or DIN 50021 and DIN EN ISO 1461.

Thermally stable max. 300 °C

Zinc spray

Art. No.	Type No.	Description
114576	3220/400	Zinc spray, 400 ml



3220/400



Repair Sticks

The uncomplicated solution for all minor repair and maintenance work.

Cut off - knead - process - use - that's all

Our epoxy resin based Repair Sticks are resistant to alcohol, ester, salt water, oils, most alkaline solutions and diluted acids.

The cured product can be machined (drilled, milled, filed) and painted over without pre-treatment.

To ensure a perfect bond, the surfaces to be joined must be clean and dry. Smooth surfaces should be roughened (e.g. by sandblasting).

Repair Stick Aluminium

For quick, non-rusting repairs or bonds of metal parts.

Patches and seals cracks, holes leakages and surface damage on car bodies, tanks, casings profiles or window frames as well as in DIY and gardening applications.

Thermally stable -50 to 120 °C



Versand in die Schweiz nicht möglich!

115.21

Repair Stick Aluminium

Art. No.	Type No.	Contents g
114583	115.21	57

Repair Stick Stainless Steel

For non-corroding repairs and reconditioning of stainless steel and other rust-proof metals, e.g. on tanks, vessels, pipes and tubes.

Thermally stable -50 to 120 °C



Versand in die Schweiz nicht möglich!

115.41

Repair Stick Stainless Steel

Art. No.	Type No.	Contents g
114585	115.41	57

Repair Stick Copper

For very fast (3 minutes) repairs of breaks, leakages and leakages on damp and wet surfaces such as pipes, tube bends, fittings, flanges, copper sheets, tanks, freezing and air conditioning systems and as repair mass for the installation and trades.

Thermally stable -50 to 120 °C

Repair Stick Copper

Art. No.	Type No.	Contents
		g
114584	115.31	57



Versand in die Schweiz nicht möglich!

115.31

Repair Stick Steel

High-quality corrosion protection for all metal surfaces. Resistant to a large number of diluted acids and alkaline solutions, weatherproof.

Suitable for use in air conditioning and ventilation systems, combustion plants, pipelines and machine housings.

Thermally stable -50 to 120 °C

Repair Stick Steel

Art. No.	Type No.	Contents
		g
114582	115.11	57



Versand in die Schweiz nicht möglich!

115.11

Repair Stick Titanium

For permanent, high-temperature and wear resistant repairs or bonds of metal parts (tanks, conduit pipes, aluminium, light metal and die-cast parts, shafts, pumps, casings, defective threads).

Thermally stable -50 to 280 °C

Repair Stick Titanium

Art. No.	Type No.	Contents
		g
114581	115.01	57



Versand in die Schweiz nicht möglich!

115.01



7



Receptacle combinations

»aircube« type - with pneumatic connection



Receptacle combination with low power connection (4 SCHUKO receptacles 16 A 2p + E 230 V) or combined low / high power connection (3 SCHUKO receptacles 16 A 2p + E 230 V, 1 CEEform receptacle 16 A 5p 400 V) plus additional pneumatic connection.
Pneumatic connection: 1 m tube with connection for 20 x 13 mm air hose and 1 two-way distributor G 1/2 with quick disconnect couplings DN 7.2.

Housing	High quality industrial plastic
Colour	Black/yellow
Integrated	Hanging eyelet and hooks
Version	Pre-wired, incl. tension spring
Protection IP	IP 20

»aircube« receptacle combination

Art. No.	Type No.	Fitted with	Connection
114498	EA 60	4 SCHUKO receptacles (1 unwired)	2 x 3-pole terminals
114499	EA 61	3 SCHUKO receptacles, 1 CEEform receptacle	1 x 3-pole terminal



Accessoires for receptacle combinations »aircube«

Art. No.	Type No.	Description
114500	EA 201	Tension spring , length 200 mm to max. 500 mm
114501	EA 202	Chain for suspension from the ceiling 3.0 m
114502	EA 203	Chain for suspension from the ceiling 5.0 m

Receptacle combinations

»cube« type



Receptacle combination with low power connection (4 SCHUKO receptacles 16 A 2p + E 230 V) or combined low / high power connection (3 SCHUKO receptacles 16 A 2p + E 230 V, 1 CEEform receptacle 16 A 5p 400 V).

Housing	High quality industrial plastic
Colour	Black/yellow
Integrated	Hanging eyelet and hooks
Version	Pre-wired
Protection IP	IP 20

»cube« receptacle combination

Art. No.	Type No.	Fitted with	Connection
114503	EA 50	4 SCHUKO receptacles	2 x 3-pole terminals
114504	EA 51	3 SCHUKO receptacles, 1 CEEform receptacle	1 x 3-pole terminal



Accessoires for receptacle combinations »cube«

Art. No.	Type No.	Description
114500	EA 201	Tension spring , length 200 mm to max. 500 mm
114501	EA 202	Chain for suspension from the ceiling 3.0 m
114502	EA 203	Chain for suspension from the ceiling 5.0 m



Receptacle combinations

»3KRAFT« type - with pneumatic connection



Receptacle combination with low power connection (3 SCHUKO receptacles 16 A 2p + E 230 V), high power or combined connections (2 SCHUKO receptacles 16 A 2p + E 230 V, 1 CEEform receptacle 16 A 5p 400 V).

Equipped with a pneumatic connection (DN 7.2 coupling with 9 mm stem).

Cable entries:

Top: 1xM32, 1xM25, 2xM 20

Side: 1xM25

One opening at the top for pneumatic connection or additional handle (all openings can be cut out).

Housing	Amaplast with hinged cover
Integrated	Hanging eyelets, wall mounting fixing and standing feet
Version	Pre-wired
Protection IP	IP 44



EA 30



EA 21

»3KRAFT« receptacle combination

Art. No.	Type No.	Fitted with	Colour
114505	EA 30	3 SCHUKO receptacles	Yellow
114506	EA 21	2 SCHUKO receptacles, 1 CEEform receptacle	Silver



EA 102



EA 103

Accessoires for receptacle combinations »3-Kraft«

Art. No.	Type No.	Description
114507	EA 101	Chains for suspension from the ceiling for »3KRAFT« model
114509	EA 103	Handle for »3KRAFT« model
114510	243.700	Quick pneumatic connection (DN 7.2 coupling and 9 mm stem)
107262	245.39	Compressed air distributor
114511	KT 29	Cable bushing



243.700



245.39



KT 29

Receptacle combinations

»AirKRAFT« type - with pneumatic connection



Receptacle combination with low power (4 SCHUKO receptacles 16 A 2p + E 230 V), high power or combined connections (3 SCHUKO receptacles 16 A 2p + E 230 V, 1 CEEform receptacle 16 A 5p 400 V).

Equipped with a pneumatic connection (DN 7.2 coupling with 9 mm stem).

Cable entries:

Top: 1xM32, 1xM25, 2xM20

Side: 1xM25

One opening at the top for pneumatic connection (all openings can be cut out).

Housing	Amaplast with hinged cover
Fusing	Beneath transparent lid (4 MW)
Integrated	Hanging eyelets, wall mounting fixing and standing feet
Version	Pre-wired
Protection IP	IP 44



EA 40



EA 31

»AirKRAFT« receptacle combination

Art. No.	Type No.	Fitted with	Colour
114512	EA 40	4 SCHUKO receptacles	Yellow
114513	EA 31	3 SCHUKO receptacles, 1 CEEform receptacle	Silver



Receptacle combinations

»AirKRAFT« type - with pneumatic connection



EA 102



243.700



245.39



KT 29

Accessoires for receptacle combinations »airkraft«

Art. No.	Type No.	Description
114508	EA 102	Chains for suspension from the ceiling for »AirKRAFT«
114510	243.700	Quick pneumatic connection (DN 7.2 coupling and 9 mm stem)
107262	245.39	Compressed air distributor
114511	KT 29	Cable bushing

Notes

A large grid of small dots for taking notes, covering most of the page.

Safety nozzle-noise graph

Compared to standard one-hole nozzles

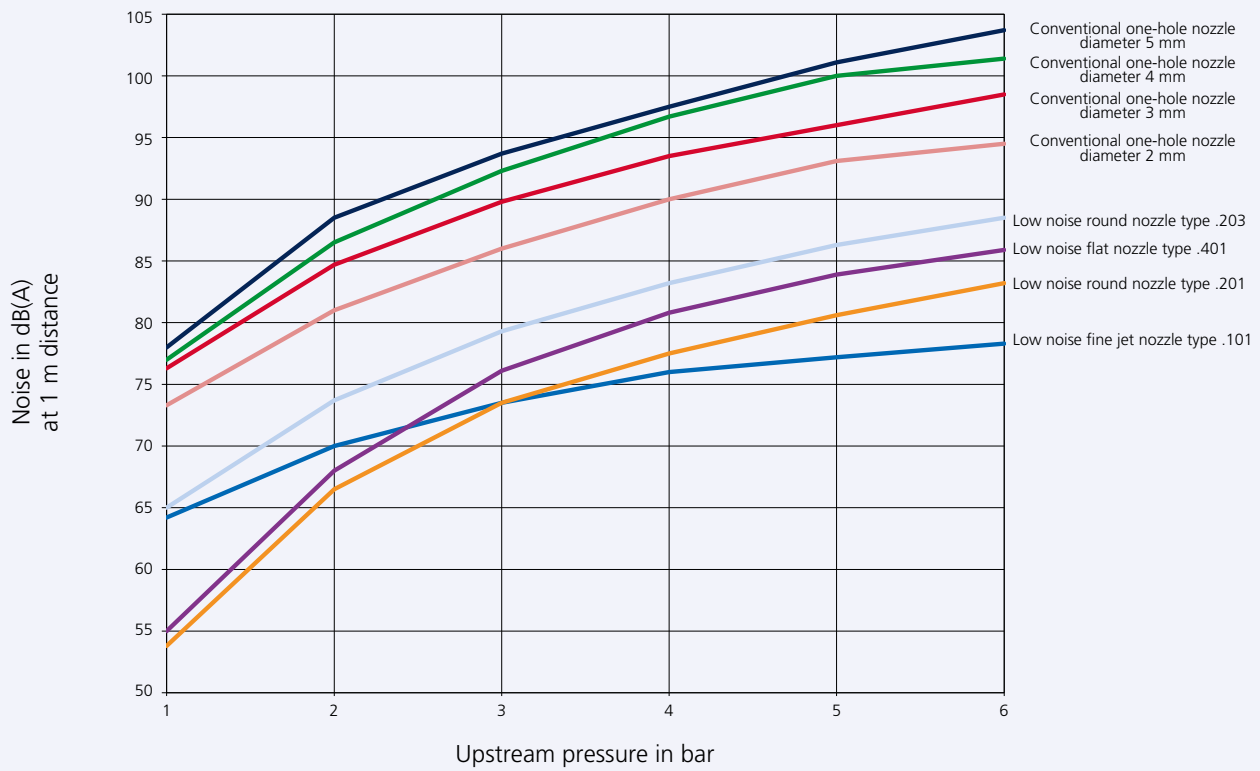

Safety nozzle charts

GRAPH 1

Type 22.101
Type 29.101
Type 30.101

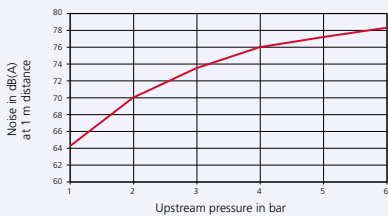
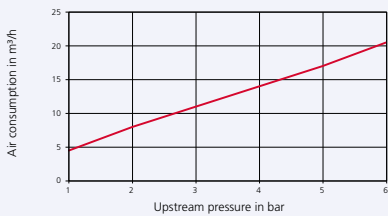
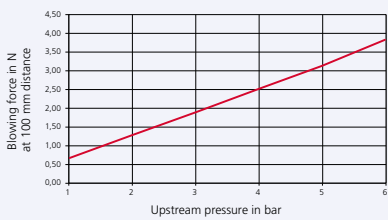

GRAPH 2

Type 22.102
Type 29.102
Type 30.102

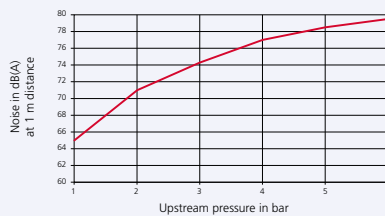
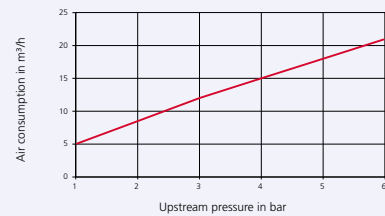
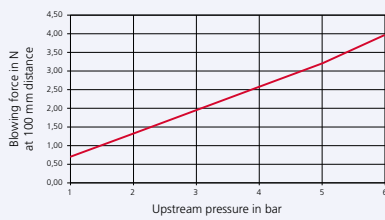

GRAPH 3

Type 22.201
Type 29.201
Type 30.201

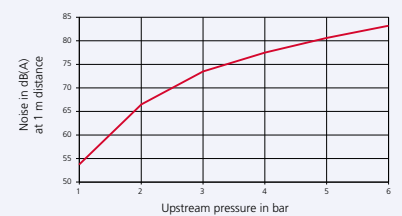
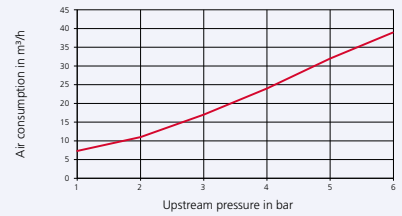
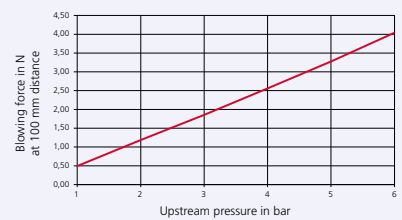

Safety nozzle charts

GRAPH 4

Type 22.202-2
Type 29.202
Type 30.202

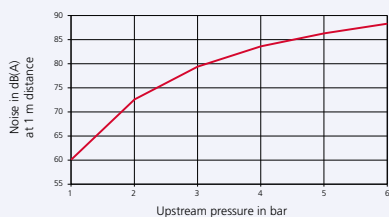
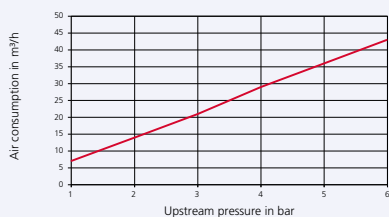
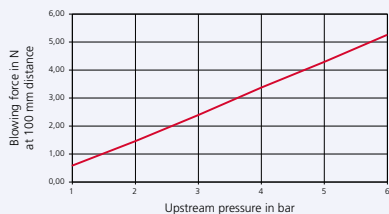

GRAPH 5

Type 22.203
Type 29.203
Type 30.203

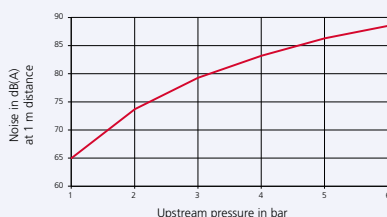
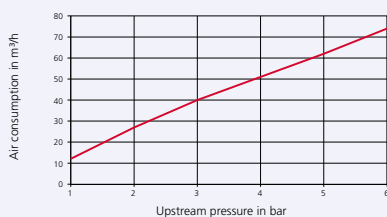
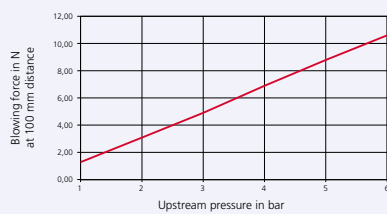

GRAPH 6

Type 22.204
Type 30.204

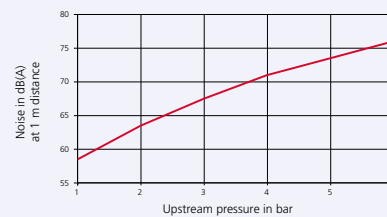
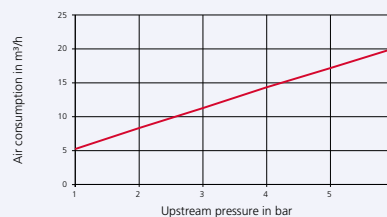
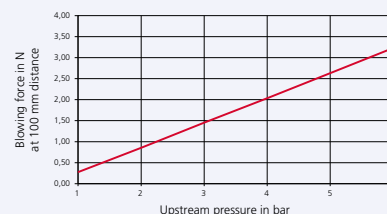

GRAPH 7

Type 22.205
Type 30.205

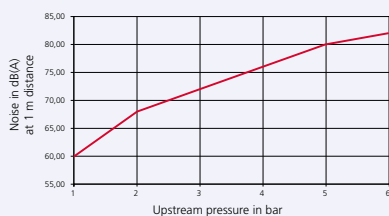
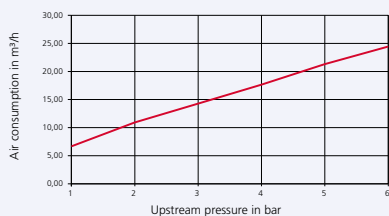
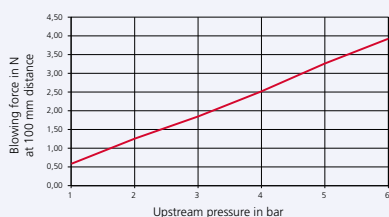

GRAPH 8

Type 22.206
Type 29.206
Type 30.206

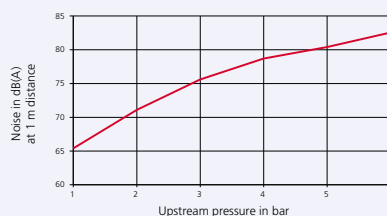
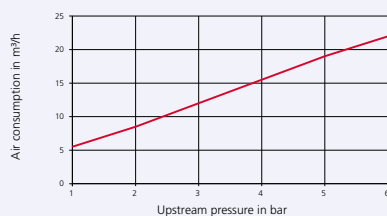
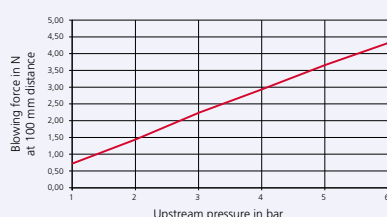

GRAPH 9

Type 22.207
Type 30.207

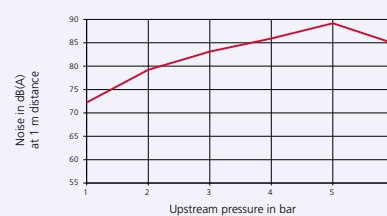
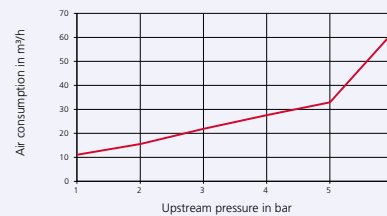
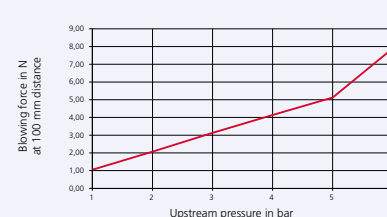

Safety nozzle charts

GRAPH 10

Type 22.208
Type 30.208

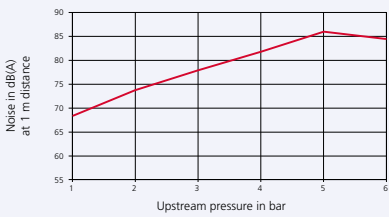
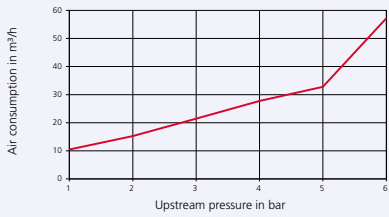
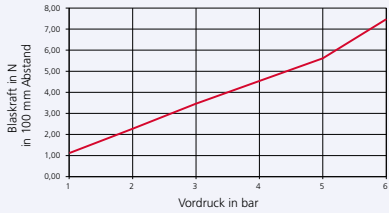

GRAPH 11

Type 22.401
Type 29.401
Type 30.401

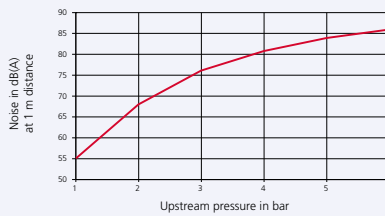
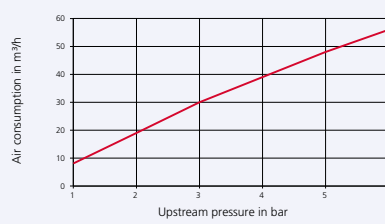
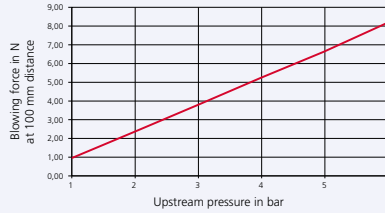

GRAPH 12

Type 22.402
Type 29.402
Type 30.402

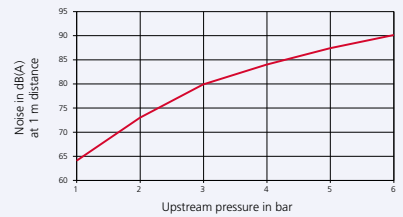
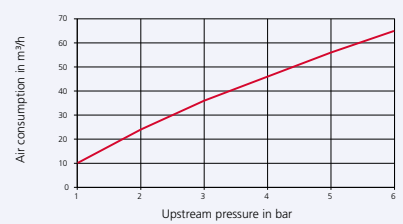
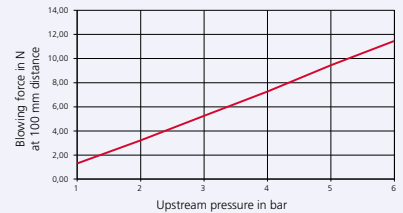

GRAPH 13

Type 22.403
Type 29.403
Type 30.404

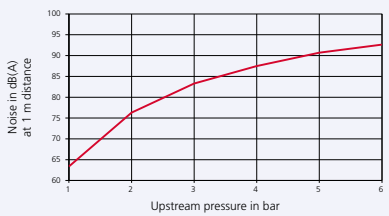
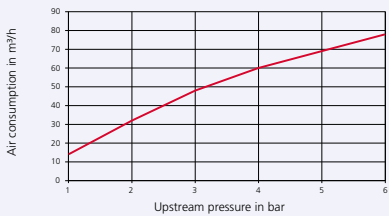
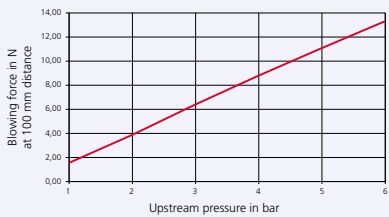

GRAPH 14

Type 30.403

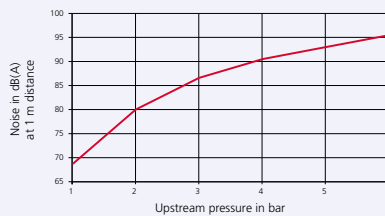
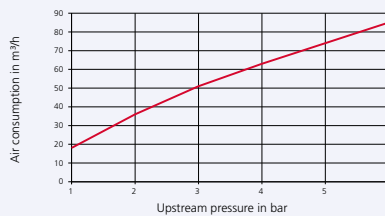
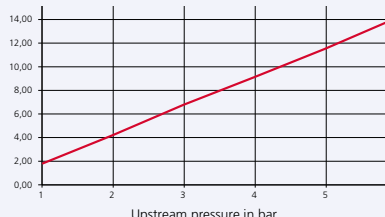

GRAPH 15

Type 30.405

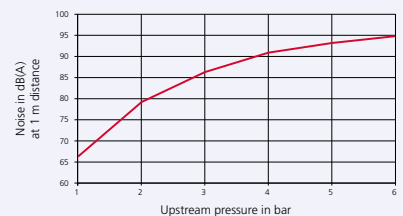
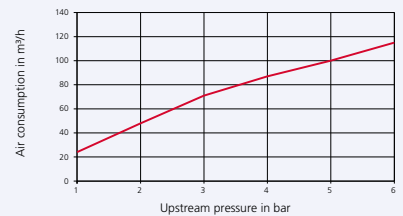
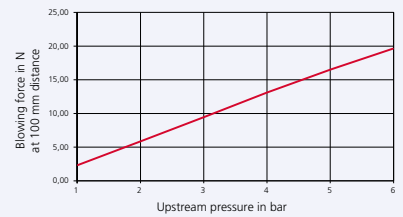

Safety nozzle charts

GRAPH 16

Type 31.101

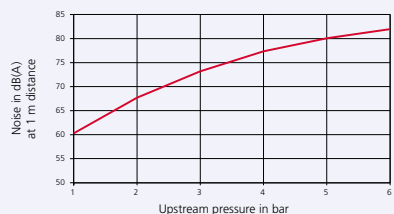
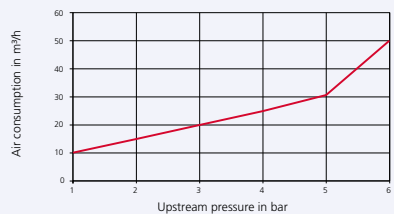
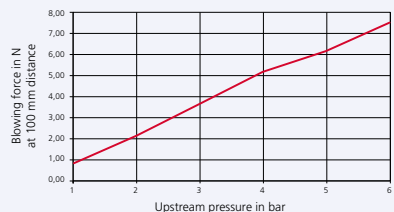

GRAPH 17

Type 31.102

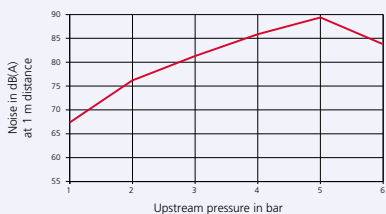
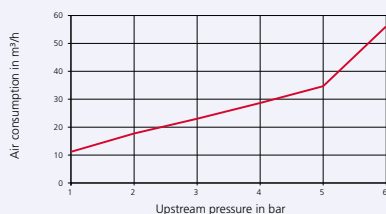
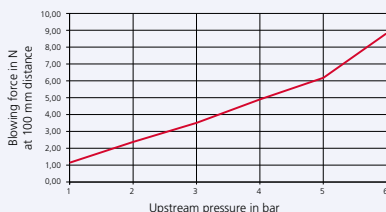

GRAPH 18

Type 22.202-2

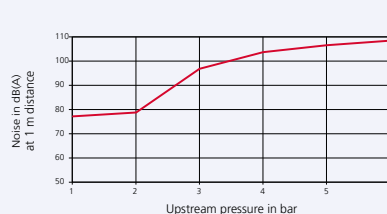
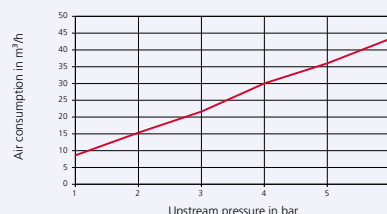
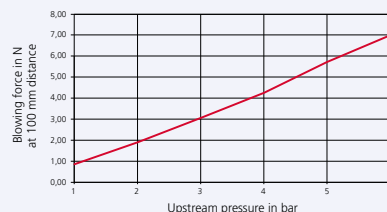

Conversion table for pressure units

Conversion table for pressure units											
	bar	mbar	Pa (N/m ²)	kPa (kN/m ²)	Torr mmHg (0 °C)	mWs (4 °C)	at kp/cm ²	inch Hg (0 °C)	inch H ₂ O (4 °C)	PSI lb/inch ²	atm
bar	1	1000	100000	100	750,062	10,1972	1,01972	29,53	401,463	14,5038	0,986923
mbar	0,001	1	100	0,1	0,750062	0,0101972	0,00101972	0,02953	0,401463	0,014504	0,000986923
Pa (N/m ²)	0,00001	0,01	1	0,001	0,007501		1,01972 x 10 ⁻⁵	0,0002953	0,004015	0,000145038	9,86923 x 10 ⁶
kPa (kN/m ²)	0,01	10	1000	1	7,501	0,10197	0,010197	0,2953	4,015	0,145038	0,00986923
Torr mmHg	0,00133322	1,33322	133,322	0,133322	1	0,0135951	0,00135951	0,03937	0,53524	0,019337	0,00131579
mWs (4 °C)	0,098067	98,0665	9806,65	9,80665	73,5559	1	0,1	2,8959	39,3701	1,42233	0,096784
at kp/cm ²	0,980665	980,665	98066,5	98,0665	735,559	10	1	28,959	393,701	14,2233	0,967841
inch Hg (0 °C)	0,033864	33,8639	3386	3,386	25,4	0,345316	0,034532	1	13,5951	0,491154	0,033421
inch H ₂ O (4 °C)	0,00249089	2,49089	249,089	0,249089	1,86832	0,0254	0,00254	0,073556	1	0,03613	0,002458
PSI lb/inch ²	0,06895	68,9476	6894,76	6,89476	51,7149	0,70307	0,070307	2,03602	27,68	1	0,068046
atm	1,01325	1013,25	101325	101,325	760	10,3323	1,03323	29,921	406,78	14,6959	1

Conversion table for temperatures

Temperatures					
Fahrenheit [°F]	Celsius [°C]	Fahrenheit [°F]	Celsius [°C]	Fahrenheit [°F]	Celsius [°C]
-40	-40	40	4,4	125	51,7
-35	-37,2	45	7,2	130	54,4
-30	-34,4	50	10,0	135	57,2
-25	-31,7	55	12,8	140	60,0
-20	-28,9	60	15,6	145	62,8
-15	-26,1	65	18,3	150	65,6
-10	-23,3	70	21,1	155	68,3
-5	20,6	75	23,9	160	71,1
0	-17,8	80	26,7	165	73,9
5	-15,01	85	29,4	170	76,7
10	-12,2	90	32,2	175	79,4
15	-9,4	95	35,0	180	82,2
20	-6,7	100	37,8	185	85,0
25	-3,9	105	40,6	190	87,8
30	-1,1	110	43,3	195	90,6
32	0	115	46,1	200	93,3
35	1,7	120	48,9		

Threads and their dimensions

Thread DIN EN ISO 228-1				
Withworth pipe thread BSP (British Standard Pipe)				
Pipe thread for connections not sealed in threads (cylindrical)				
Rated thread size	Outside diameter	Core hole diameter	Turns per inch	Pitch
	[mm]			[mm]
G 1/8"	9,728	8,566	28	0,907
G 1/4"	13,157	11,445	19	1,337
G 3/8"	16,662	14,950	19	1,337
G 1/2"	20,955	18,631	14	1,814
G 5/8"	22,911	20,587	14	1,814
G 3/4"	26,441	24,117	14	1,814
G 1"	33,249	30,291	11	2,309
G 1 1/4"	41,910	38,952	11	2,309
G 1 1/2"	47,808	44,845	11	2,309
G 2"	59,614	56,656	11	2,309
G 2 1/2"	75,184	72,226	11	2,309
G 3"	87,884	84,926	11	2,309
G 3 1/2"	100,330	97,372	11	2,309
G 4"	113,030	110,972	11	2,309

Thread DIN EN 10226-1 / ISO 7/1					
Tapered Withworth pipe thread BSPT (British Standard Pipe Tapered)					
Pipe thread with cylindrical female thread / conical (1:16) male thread					
>External< thread identification	Rated diameter	>External< diameter	Core hole diameter	Turns per inch	Pitch
	[mm]	[mm]	[mm]		[mm]
R 1/8"	6	9,728	8,566	28	0,907
R 1/4"	8	13,157	11,445	19	1,337
R 3/8"	10	16,662	14,950	19	1,337
R 1/2"	15	20,995	18,631	14	1,814
R 3/4"	20	26,441	24,117	14	1,814
R 1"	25	33,249	30,291	11	2,309
R 1 1/4"	32	41,910	38,952	11	2,309
R 1 1/2"	40	47,803	44,845	11	2,309
R 2"	50	59,614	56,656	11	2,309
R 2 1/2"	65	75,184	72,226	11	2,309
R 3"	80	87,884	84,926	11	2,309
R 4"	100	113,030	110,072	11	2,309



Sealing materials

The most important sealing materials					
Abbreviations	Description	Registered trademark	Area of application	Temperature	Product groups
NBR	Nitrile butadiene rubber	Perbunan®	In hydraulics and pneumatics, resistance against hydraulic oils, water glycol and oil-water emulsions, mineral oils and mineral oil products, animal and vegetable oils, petrol, heating oil, water up to approx. 70 °C, air up to 80 °C, butane, propane, methane, ethane.	-30 to 80 °C	Maintenance units, cylinders and control valves Screw connections / connectors
FKM FPM	Fluorinated rubber Fluorocarbon rubber	Viton®	FPM is characterised by outstanding resistance against high temperatures, ozone, oxygen, mineral oils, synthetic hydraulic fluids, fuels, aromatics, many organic solvents and chemicals. The gas permeability is low and similar to that of butyl rubber.	-25 to 200 °C	Valves and shut-off devices Couplings Screw connections / connectors Cylinders and control valves
EPDM	Ethylene propylene rubber		Steam up to 200 °C, hot water, air up to 150 °C, diluted acids, not resistant to mineral oil products.	200 °C	Check valves (on request) Couplings (on request)
CR	Polychloroprene rubber, chlorinated rubber	Neoprene®	Resistant against silicone oils and greases, refrigerants, better ozone resistance, weatherproof and ageing resistance to NBR.	-40 to 100 °C	Solenoid valves
PTFE	Polytetrafluoroethylene	Teflon®	Resistant to almost all organic and inorganic chemicals (except for elemental fluorine under pressure or at high temperatures, fluorine halogen compounds and molten alkaline metal). - strong anti-adhesive properties - no water absorption (<0.01%) - low heat conductivity	-200 to 260°C	Valves and shut-off devices

Materials and their areas of application

Materials and their areas of application			
Stainless steel			
Material	Chemical designation	AISI	Areas of application
1.4301	X5CrNi18-10	AISI 304	Equipment and components of the chemical industry, textile industry, dyeworks, as well as in the photographic, paint, synthetic resin and rubber industries
1.4305	X10CrNiS18-9	AISI 303	Turned parts of the food and dairy industry, photographic, oil, soap, paper and textile industries
1.4401	X5CrNiMo17-12-2	AISI 316	Parts and equipment in the pulp, textile, oil and rayon industries, dairies, breweries.
1.4404	X2CrNiMo17-12-2	AISI 316 L	Parts and equipment in the pulp, textile, oil and rayon industries, dairies, breweries. Use as cast material for investment casting fittings.
1.4408	G-X6CrNiMo18-10	similar to AISI 316	Material for investment casting fittings
1.4571	X6CrNiMoTi17-12-2	AISI 316Ti	Equipment and components of the chemical industry, textile industry, dyeworks, as well as in the photographic, paint, synthetic resin and rubber industries.
Brass			
Material	Chemical designation	Areas of application	
2.0331	CuZn39Pb2	<ul style="list-style-type: none"> • Sanitary appliances, screw connections, bolts, nuts • Drop forged components, stamped parts, gears, gear racks • Parts for security locks in vehicles, keys • Watch cases, watch circuit boards, barrels, date rings • Luster terminals • Perforated panels (for the paper industry) • Signs, metal letters, rivet parts 	

Air treatment/filtering

Air treatment							
Filtering							
<p>The compressed air must always be clean so that it does not cause malfunction or does not damage the components. Dirt causes increased wear and negatively influences the service life of the pneumatic elements.</p> <p>Since the filter in the system forms a resistance to flow, for economical reasons the efficiency of the filter should be adjusted to the requirements of the application the air should be as clean as is necessary. This is specified in DIN ISO 8573-1:2010 into various cleanliness classes so that a uniform assessment of the degree of cleaning is possible.</p> <p>Depending on the requirements of the application, there are different demands on the compressed air quality. The quality classes should contain the following information in the order given:</p> <p>Quality classes: units for different impurities</p> <ol style="list-style-type: none"> 1. Solid particles 2. Water (liquid/vapor) 3. Oil (liquid/vapor) 							
Quality class	1. Solids			2. Water		3. Oil	
	Maximum number of particles per m ³ Particle size d [µm]			Concentration C _p [mg/m ³]	Pressure dew point [°C] max.	Water concentration (liquid) C _w [g/m ³]	Oil concentration (droplets, aerosols, vapors) [mg/m ³]
0,1 < d ≤ 0,5	0,5 < d ≤ 1,0	1,0 < d ≤ 5,0					
0	Determined by the equipment supplier or user with higher requirements than class 1.						
1	≤ 20.000	≤ 400	≤ 10	Not defined	≤ -70	Not defined	≤ 0,01
2	≤ 400.000	≤ 6.000	≤ 100		≤ -40		≤ 0,1
3	Not defined	≤ 90.000	≤ 1.000		≤ -20		≤ 1
4		≤ 10.000	≤ +3		≤ 5		
5		≤ 100.000	≤ +7	Not defined			
6	Not defined	Not defined	0 < C _p ≤ 5		≤ +10		
7			5 < C _p ≤ 10		Not defined	C _w ≤ 0,5	
8			Not defined			Not defined	0,5 < C _w ≤ 5
9							5 < C _w ≤ 10
X					C _p > 10		C _w > 10



Vacuum

Vacuum				
Vacuum is indicated in relation to the absolute pressure (absolute zero). Description: - Data (minus data) given in percent (%) in range from 0 – 1 bar absolute pressure				
Application in the use with rough or work vacuum at Riegler				
<p>Vacuum as relative value in proportion to the average atmospheric ambient pressure (approx.1000 mbar). The indicated vacuum value has a negative sign, because the atmospheric ambient pressure is taken as zero. This results that the lowest accepted value is -1 bar or 100% vacuum.</p>				
Distribution of the vacuum levels				
Unit	Rough vacuum	Fine vacuum	High vacuum	Ultra-high vacuum
mbar	10 ³ to 1	1 to 10 ⁻³	10 ⁻³ to 10 ⁻⁷	< 10 ⁻⁷

Solenoid valves

Solenoid valves 2/2-3/2 directional media valves	
Types of actuation	
Directly actuated valve	
Description	Design related features
<p>For a directly actuated valve the solenoid armature is connected mechanically with the valve plate and form a power unit. The magnet, which works directly on the armature, thus actuates simultaneously the sealing element attached to the bottom of the armature. Operation is not influenced by the line pressure or the flow, and the valve functions from zero up to maximum allowable rated pressure.</p>	<p>Only small nominal diameters – low flow capacities High pressures Liquid and gaseous media in the scope of the specifications Switches without pressure differenced Use with rough vacuum</p>
Pilot operated valve	
<p>This valve is equipped with a pilot operated valve and a throttle hole. It uses the line pressure for its function. When the solenoid is energised the pilot operation is opened and the pressure is built up via the valve piston or the diaphragm toward the outlet side of the valve. The pressure differenced resulting from this forces the line pressure to lift the piston or the diaphragm from the main seat and opens the valve. When the solenoid is energised the pilot operation opening is closed and the line pressure can be built up again by the nozzle via the piston or the diaphragm and provide the required force for closing the valve.</p>	<p>Larger nominal diameters Higher pressures can be switched with relatively low solenoid powers Liquid and gaseous media in the scope of the specifications Switching function only possible with minimum pilot pressure (observe "minimum operating pressure" in the catalogue) Bei größeren Nennweiten nehmen die schaltbaren For larger nominal diameters reduce the switchable pressures (observe "maximum operating pressure" in the catalogue)</p>
Positively controlled valve	
<p>With this type of actuation the advantages are combined with the principle of direct actuation. With positively controlled valves the solenoid armature and seal are mechanically connected. The opening cycle can begin without differential pressure. As this movement continues the pre-pressure supports the opening cycle via the additionally available pilot hole. The valves work from 0 bar up to the maximum allowable pressure.</p>	<p>Larger nominal diameters Switching function possible without minimum pre-pressure Liquid and gaseous media in the scope of the specifications For larger nominal diameters reduce the switchable pressures (observe "maximum operating pressure" in the catalogue)</p>

Cylinder Forces

Theoretical cylinder forces for double-acting cylinders

Pressure - Force table

Piston force [daN] 1 daN (10N) = approx. 1 kg

Ø piston [mm]	Ø rod [mm]	Piston area [cm ²]		Control pressure [bar]													
				2		3		4		5		6		7		8	
		Pres- sure	Ten- sion	Pres- sure	Ten- sion	Pres- sure	Ten- sion	Pres- sure	Ten- sion	Pres- sure	Ten- sion	Pres- sure	Ten- sion	Pres- sure	Ten- sion	Pres- sure	Ten- sion
8	4	0,5	0,38	1,0	0,8	1,5	1,1	2,0	1,5	2,5	1,9	3,0	2,3	3,5	2,6	4,0	3,0
10	4	0,79	0,66	1,6	1,3	2,4	2,0	3,1	2,6	3,9	3,3	4,7	4,0	5,5	4,6	6,3	5,3
12	6	1,13	0,85	2,3	1,7	3,4	2,5	4,5	3,4	5,7	4,2	6,8	5,1	7,9	5,9	9,0	6,8
16	6	2,01	1,73	4,0	3,5	6,0	5,2	8,0	6,9	10,1	8,6	12,1	10,4	14,1	12,1	16,1	13,8
16	8	2,01	1,51	4,0	3,0	6,0	4,5	8,0	6,0	10,1	7,5	12,1	9,0	14,1	10,6	16,1	12,1
20	8	3,14	2,64	6,3	5,3	9,4	7,9	12,6	10,6	15,7	13,2	18,8	15,8	22,0	18,5	25,1	21,1
20	10	3,14	2,36	6,3	4,7	9,4	7,1	12,6	9,4	15,7	11,8	18,8	14,1	22,0	16,5	25,1	18,8
25	8	4,91	4,41	9,8	8,8	14,7	13,2	19,6	17,6	24,5	22,0	29,5	26,4	34,4	30,8	39,3	35,2
25	10	4,91	4,12	9,8	8,2	14,7	12,4	19,6	16,5	24,5	20,6	29,5	24,7	34,4	28,9	39,3	33,0
32	12	8,04	6,91	16,1	13,8	24,1	20,7	32,2	27,6	40,2	34,6	48,3	41,5	56,3	48,4	64,3	55,3
40	12	12,57	11,44	25,1	22,9	37,7	34,3	50,3	45,7	62,8	57,2	75,4	68,6	88,0	80,0	100,5	91,5
40	16	12,57	10,56	25,1	21,1	37,7	31,7	50,3	42,2	62,8	52,8	75,4	63,3	88,0	73,9	100,5	84,4
50	16	19,63	17,62	39,3	35,2	58,9	52,9	78,5	70,5	98,2	88,1	117,8	105,7	137,4	123,4	157,1	141,0
50	20	19,63	16,49	39,3	33,0	58,9	49,5	78,5	66,0	98,2	82,5	117,8	99,0	137,4	115,5	157,1	131,9
63	16	31,17	29,16	62,3	58,3	93,5	87,5	124,7	116,6	155,9	145,8	187,0	175,0	218,2	204,1	249,4	233,3
63	20	31,17	28,03	62,3	56,1	93,5	84,1	124,7	112,1	155,9	140,2	187,0	168,2	218,2	196,2	249,4	224,2
80	20	50,27	47,12	100,5	94,2	150,8	141,4	201,1	188,5	251,3	235,6	301,6	282,7	351,9	329,9	402,1	377,0
80	25	50,27	45,36	100,5	90,7	150,8	136,1	201,1	181,4	251,3	226,8	301,6	272,1	351,9	317,5	402,1	362,9
100	25	78,54	73,63	157,1	147,3	235,6	220,9	314,2	294,5	392,7	368,2	471,2	441,8	549,8	515,4	628,3	589,0
125	32	122,72	114,68	245,4	229,4	368,2	344,0	490,9	458,7	613,6	573,4	736,3	688,1	859,0	802,7	981,7	917,4
160	40	201,06	188,5	402,1	377,0	603,2	565,5	804,2	754,0	1005,0	942,5	1206,0	1131,0	1407,0	1320,0	1609,0	1508,0
200	40	314,16	301,59	628,3	603,2	942,5	904,8	1257,0	1206,0	1571,0	1508,0	1885,0	1810,0	2199,0	2111,0	2513,0	2413,0

Theoretical cylinder forces for single-acting cylinders

Single-acting short stroke cylinders

Diameter [mm]	Blocking force of the spring N	max. stroke [mm]	Force with relaxed spring N
12	6	25	1,5
16	7	25	3
20	12	25	4
25	14	25	5
32	33	50	6
40	45	50	15
50	70	50	20
63	81	50	25

Single-acting cylinder acc.to ISO 6432



8	3	50	1
10	5	50	1
12	7	50	3
16	20	50	5
20	22	50	12
25	28	50	17

Recommendation:

Normally in practise the pneumatic cylinder is set up to approx. 75 % of the theoretical cylinder force.



Industrial adhesive

RIEGLER Lock							
Adhesive	Application	Strength	Viscosity	Characteristics	Max. gap bridging in mm	For threaded connections up to	Temp. resistance in °C
AN 301-43 	Screw lock, DVGW tested	Medium tight	Higher viscosity	No label, high health protection	0,25	M 36	-60° to 150°C
AN 301-72 	Pipe, thread, flat PTFE seal, DVGW tested	Medium tight	High viscosity	No label, high health protection	0,3	M 80 3"	-60° to 200°C
AN 302-21	Screw lock, vibration protection	Low strength	Low viscosity	Easy to separate	0,1	M 12	-60° to 150°C
AN 302-43 	Screw lock, DVGW tested	Medium tight	Higher viscosity	Disassembled normally	0,25	M 36	-60° to 150°C
AN 302-60	Screw lock for passive materials such as stainless steel and aluminium	High strength	Medium viscosity	Difficult to separate	0,15	M 20 3/4"	-60° to 180°C
AN 302-70	For locking screws and stud bolts	High strength	Medium viscosity	Difficult to separate	0,15	M 20 3/4"	-60° to 150°C
AN 305-77 	Pipe and thread seal, DVGW tested	Medium tight	High viscosity	Disassembled normally	0,5	M 80 3"	-60° to 150°C
AN 306-20 	Joint connection, DVGW tested	High strength	Higher viscosity	Difficult to separate	0,2	M 56 2"	-60° to 200°C

ENERGY EFFICIENCY – DETERMINING LEAKS IN COMPRESSED AIR SYSTEMS



Existing compressed air systems frequently show enormous optimisation potential. This can lead to significant cost savings and at the same time contribute to the protection of resources and the climate.

In Germany alone 62,000 installed compressed air systems annually consume 14 billion kWh of electrical energy. At least 15% to 20% of this could be easily saved. (Source: Fraunhofer Institut, Karlsruhe).

COST DISTRIBUTION OF A COMPRESSED AIR SYSTEM

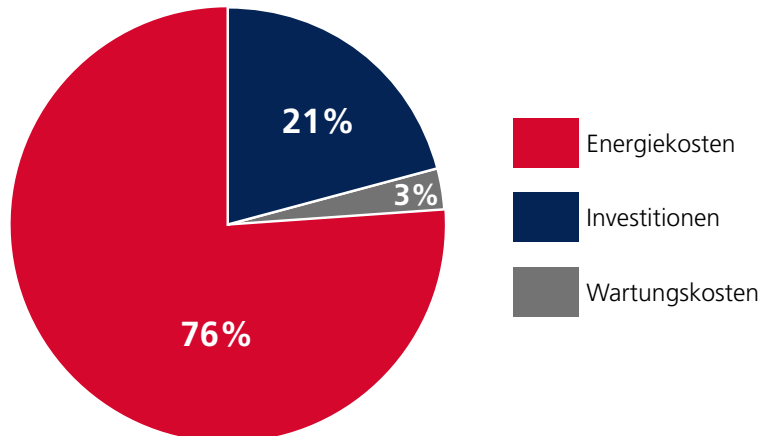

A large part of these costs occur from leaks in the compressed air system. The air “escapes” unused. The energy costs to compensate for the resulting compressed air losses are considerable.

ANNUALLY OCCURRING COSTS DUE TO LEAKS:

Hole in mm	Air loss/second		Air loss/year		Costs/year	
	on 6 bar (l/s)	on 12 bar (l/s)	on 6 bar m³/year	on 12 bar m³/year	on 6 bar Euro	on 12 bar Euro
1	1,2	1,8	34.560	51.840	691	1.037
3	11,1	20,8	319.680	599.040	6.394	11.981
5	30,9	58,5	889.920	1.684.800	17.798	33.696

Source: VDMA
 Calculation based on:
 Compressed air system 8000 h/year in operation
 Assumed costs 0,02€/Nm³

USING THE LS 250 ULTRASONIC LEAK TESTING DEVICE EVEN THE SMALLEST LEAKS CAN BE LOCATED QUICKLY AND EASILY (CATALOGUE PG. 185)



Compressed air piping system

Important installation instructions

If the compressed air piping system plans for vertical stubs along a wall, it is recommended to first attach the wall brackets only on the horizontally running pipes and then apply the installation with pressure.

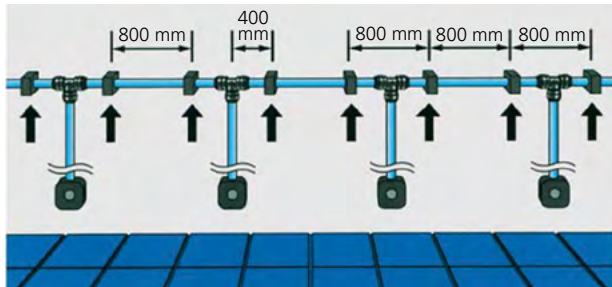

Phase 1: System without pressure

Only now should the mounting of the vertical wall brackets and the fastening of the compressed air tapping points (Air distributor socket product no.114026, 114027, 114028) be carried out.

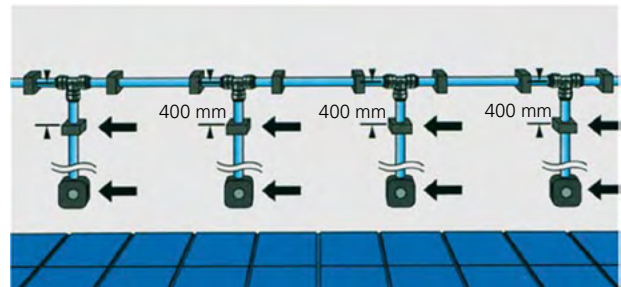

Phase 2: Fastening the line that has pressure applied

Laying a pipe around columns or obstacles requires that an appropriate distance between the wall and the connector is accounted for. This can be carried out with the installation of an expansion loop as illustrated below. Also a minimum distance of min. 10 cm must be guaranteed between the connector and wall bracket (pipe clamp).

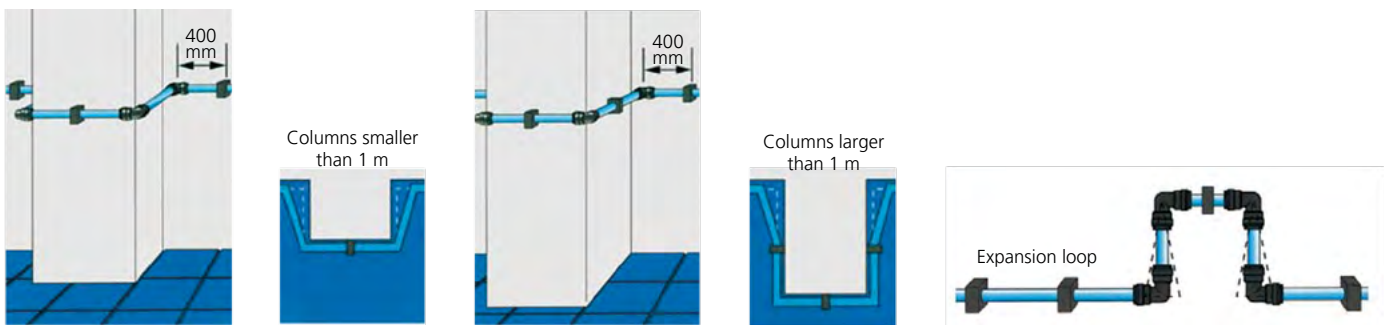

If the piping is planned over greater distances, it is recommended to plan for an expansion loop every 25 meters, (as shown in the drawing to the right). Basically outlet pipes should be designed with a so-called water separator (gooseneck). We recommend here our product no. 114065.

Through the user friendly design of the compressed air piping system it is possible to carry out installation and removal without any type of tools. Along with a considerable time savings, this also has a cost savings of up to 50%.

In order to guarantee a smooth installation, observe the following points:

- The pipe clamps must be mounted so that the pipe still has sufficient play to shift due to longitudinal expansion
- Another important point to observe is that no burr is on the ends of the pipe in order to prevent damage to the "O" rings of the connectors when plugging together.
- Basically we recommend providing the pipes with a chamfer, in order to reduce the plugging force.
- So that an optimum pipe cut (90 °) is achieved, this should fundamentally be done with our pipe cutter, product 114078.
- To prevent pressure losses in the system, always make sure to push the pipes to the stop in the connector (also see the mark on the connector).
- During installation of the compressed air piping system around columns, the longitudinal expansion of the pipes and connectors must also be taken into account. We recommend a wall distance of approx. 30 mm.

- During installation of several vertical pipes, we recommend to first mount the pipe clamps of the horizontal lines, place the system under pressure and in a 2nd step mount the vertical clamps and connectors. This prevents the vertical pipes to become skewed after installation.
- If there is no refrigerant dryer available during installation of the compressed air piping system, it is recommended to use our T-connector with integrated water separator (Product No.114065). Thus the condensed water can be collected at a specific point.

Calculation of the longitudinal expansion for polyamide pipes*

Before installation of the compressed air piping system a correct thermal expansion calculation must be performed, in order to prevent bending of the pipes and connections.

The following factors for longitudinal expansion of polyamide pipes must be taken into account:

	Factor
PA -12 pipe (soft)	1,5
PA -12 pipe (hard)	1,0

Specific coefficient of longitudinal expansion for polyamides = $10^{-4}/C^{\circ}$

The following formula must be used for calculation of the longitudinal expansion:

$$\begin{aligned}
 & \text{Factor (PA-pipe)} \\
 & \times \text{ spec. coefficient of longitudinal expansion (10-4/C}^{\circ}\text{)} \\
 & \times \text{ Line length (L)} \\
 & \times \text{ Temperature } (\Delta T) \\
 & = \Delta L
 \end{aligned}$$

Example calculation:

A compressed air line of 150 m length that is laid in a hall (hard polyamide pipe) whose ambient temperature is between 15 and 40 °C (T thus 25 °C) expands by

$$\Delta L = 1,0 \times 10^{-4}/C^{\circ} \times 150 \text{ m} \times 25 \text{ }^{\circ}\text{C}$$

$$\Delta L = 0,375 \text{ m.}$$

Example for piping calculation*

Compressed air distribution with ring circuit

For the dimensioning of the ring circuit, half of the nominal length of the entire piping and the entire compressed air consumption must be taken into account.

Example: Compressed air consumption 1000 l/min. Operating overpressure 7 bar, entire piping lengths were 300 m, a ring circuit of 150 m is calculated.

Compressed air distribution with stubs

For the dimensioning of the stubs the entire piping length and the entire compressed air consumption must be taken into account.

Example: Compressed air consumption 750 l/min. Operating overpressure 7 bar, entire piping lengths were 50 m.



Notes

A large grid of small dots arranged in approximately 30 columns and 40 rows, intended for taking notes.

RIEGLER SAFETY



BETTER

MEANS

SAFER.

WITH OUR SPECIAL RIEGLER SAFETY PROGRAM,
YOU CAN MAKE YOUR COMPRESSED AIR APPLICATIONS
SAFER AND MORE EFFICIENT – AND THUS EVEN BETTER.



- Components for accident prevention and safety at work
- Safe and healthy at work
- Legally required products according to currently applicable laws, standards, directives, and regulations
- Energy-efficient components
- Reduction of occupational accidents and improvement in occupational safety
- Expansion of competence in the field of compressed air technology



WE ARE ON SITE FOR YOU.

WHATEVER THE REQUIREMENTS OF YOUR COMPRESSED AIR SYSTEM AND YOUR PNEUMATIC APPLICATION, OUR EXPERTS WILL FIND THE ANSWERS.

Do you have any questions? We are pleased that you have chosen RIEGLER.

Let us show you how we're SIMPLY THAT BIT BETTER. In our flexible divisions, your personal contacts from internal sales, customer service, and technical field service – as your specialist on the ground – are there for you.

Talk to us, we give you our performance promise. At a glance, here are the regional contact details of your personal contacts in our sales department, separated into divisions.

 PLZ			
32-33 40-42 44-48 50-54 56-59	+49 7125 9497-491	div1@riegler.de	Division 1
34-37 55 60-79 88-89	+49 7125 9497-492	div2@riegler.de	Division 2
01-31 38-39 49 90-93 95-98	+49 7125 9497-493	div3@riegler.de	Division 3
80-87 94 A, CH	+49 7125 9497-494	div4@riegler.de	Division 4
Inter- national	+49 7125 9497-222	export@riegler.de	Export

We dedicate ourselves entirely to compressed air technology and pneumatics for you. So we want to see the world through your eyes – because only when we are close to our customers and understand their challenges can we offer a truly perfect solution.



OUR REGIONS: GERMANY – AUSTRIA – SWITZERLAND

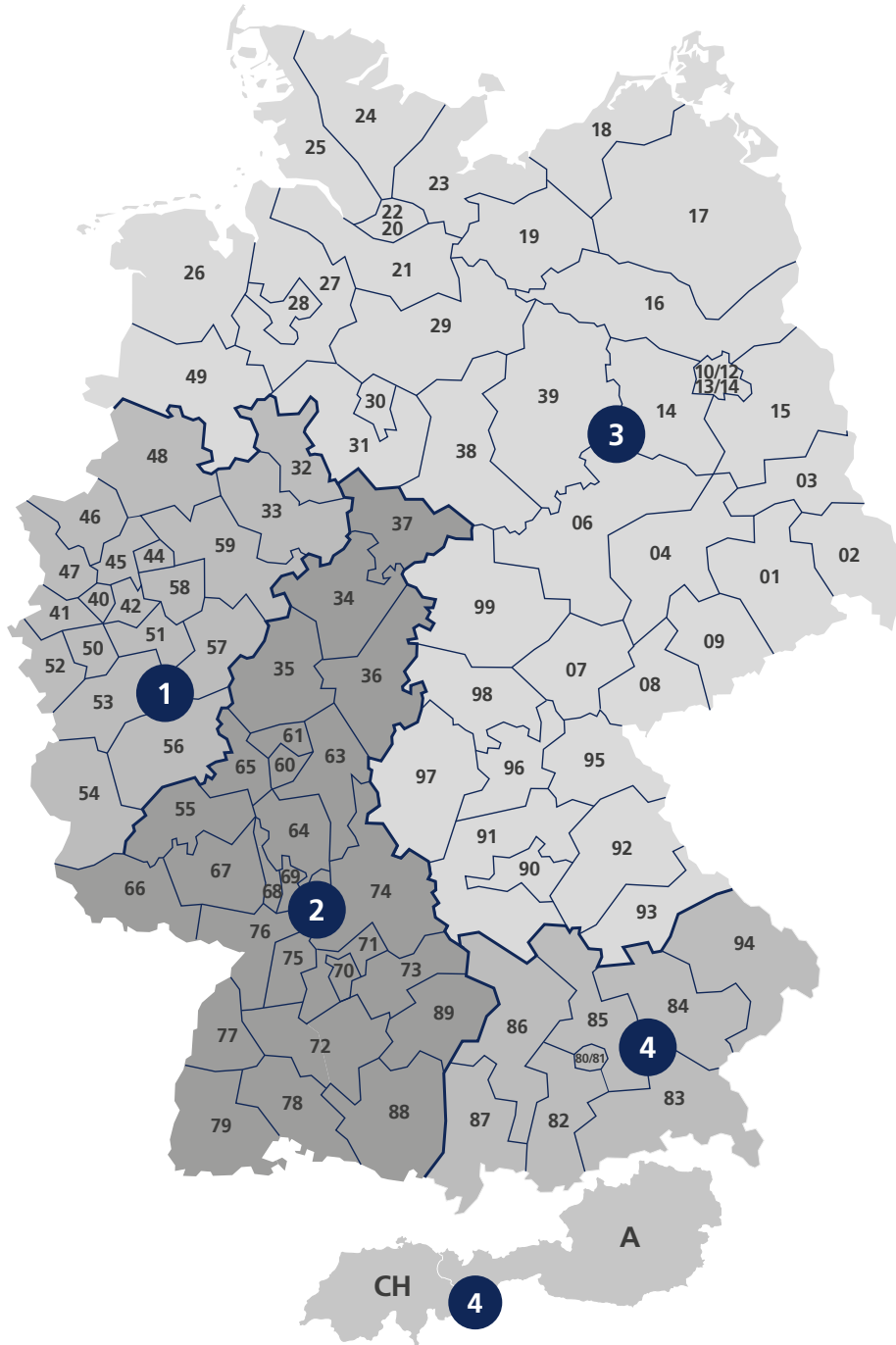

EXPORT

We supply you worldwide, including via your or our local partner dealers if that's better.



IF TOP PERFORMANCE IS YOUR GOAL, THEN WE'RE YOUR TOOL.



SALES

- Bundled market and technical expertise
- Individual personal support and advice – including directly at your site
- Individual solutions
- Long-term partnerships
- Key account management/target market-oriented approach
- High customer satisfaction
- Process optimization
- Supplier bundling
- High service level
- Professional sales support
- Online store
- Partner online stores
- Electronic catalogs
- Interface solutions



LOGISTICS

- Inventory optimization
- Set provision and kitting according to your requirements
- Individual labeling
- Just-in-time deliveries
- Overnight delivery
- Neutral shipping
- Free delivery from EUR 75 for orders in the online store
- Delivery status can be viewed online at any time in the Customer InfoCenter
- Do you have an individual request? Please feel free to contact us.



TECHNOLOGY

- Technical consulting
- Design and development
- CAD
- Range breadth and product diversity
- Application-oriented solutions
- Sample and prototype construction (including 3D printing)
- Standardization and optimization
- Application videos and webisodes
- Technical documentation
- Certifications and certificates

Learn more at:

en.riegler.de/engineering





RIEGLER ACADEMY

As your dynamic and proactive partner, we always keep you up to date with the latest knowledge. Which is why we provide you with regular training in compressed air technology and pneumatics.

Theory units are held in our large seminar room with modern presentation technology. Practical seminar content is taught at workstations where complex pneumatic controls can also be put into operation.



SEMINAR OFFERING

Attend one of our day seminars in Bad Urach for up to 30 people, including a practice room with pneumatic control technology.

- Compressed air technology
- Pneumatics
- RIEGLER SAFETY
- RIEGLER Energy
- Sales excellence using technical expertise

Efficiently designed for you:
If on-site sessions are not possible, we offer 1.5-hour webinars.



Notes

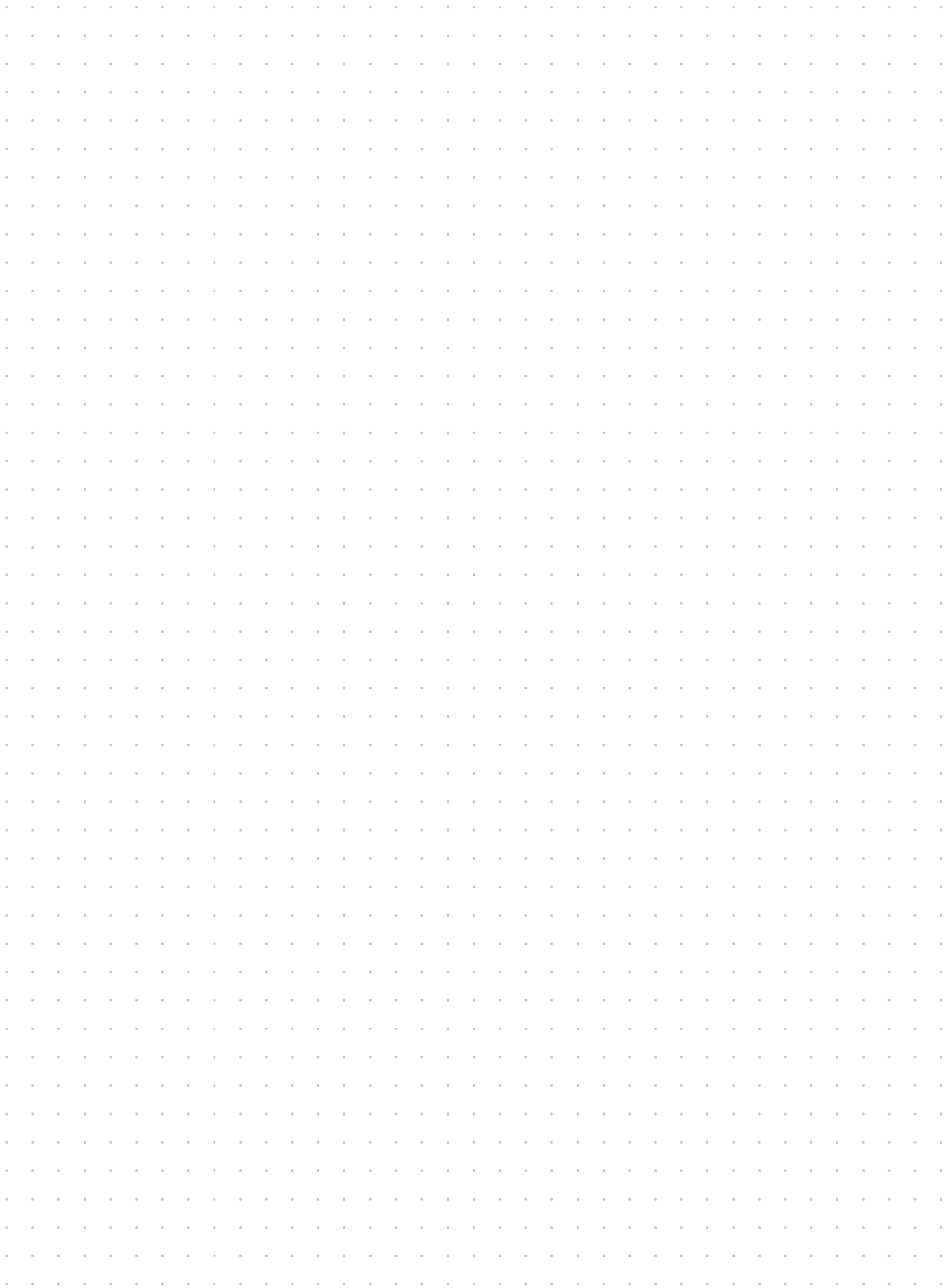

GENERAL TERMS AND CONDITIONS

All current and future agreements, offers and orders in the company are based on the following General Terms and Conditions. Differing, conflicting or supplementary general terms and conditions of the Customer do not constitute part of the contract, unless their applicability is expressly agreed to in writing. Otherwise, exclusively our General Terms and Conditions shall apply.

1. Ordering and order acceptance

- (1) Our offers are non-binding and subject to change without notice, unless expressly agreed to otherwise. They are subject to technical changes and changes in shape, colour and/or weight within a reasonable scope. We reserve the right to provide excess or short deliveries of up to 10%. Furthermore, authorised and excess or short deliveries by suppliers, which are allowed under the General Terms and Conditions, are provided in excess or short delivery in the same scope. The execution of the order takes place in the context of technically necessary materials and process engineering tolerances. We reserve the right to deviations in the quality of materials in accordance with the delivery terms of the suppliers.
- (2) By ordering the goods, the Customer makes a binding declaration of intent to purchase the ordered goods. We are entitled to accept the contractual offer contained in the order within 2 weeks of receipt. The acceptance can be declared either in writing or by delivering the goods to the Customer. All orders issued to us either directly by the Customer or through sales representatives require acceptance, unless it concerns a cash transaction.
- (3) The conclusion of contract is subject to correct and timely delivery on the part of our suppliers. The Customer will be informed immediately regarding the unavailability of the service. Provided that the non-delivery is not attributable to us, in particular where a congruent hedging transaction is concluded with our suppliers, we shall be exempt from our performance obligations to the extent that these have been correspondingly hindered or delayed.

2. Delivery and delivery times

- (1) The agreed delivery times are approximate times. Agreements regarding fixed deadlines are valid only upon our express written confirmation.
- (2) The agreed delivery times start no earlier than the date of order confirmation. However, the delivery period starts only when all documents and other records required for the execution of the order are at our disposal. So long as the Customer is in arrears with pre-performance obligations we shall be exempt from our delivery obligation. In case of culpable failure to comply with an agreed delivery time, the delivery is deemed to have been delayed only after the expiry of a reasonable grace period.
- (3) In case of force majeure – this includes such circumstances and events that cannot be prevented with the due diligence of prudent business management – the contractual obligations of the Parties shall be suspended for the duration of the disruption and the extent of its impact. Should the resulting delays exceed a period of ten weeks, both Contracting Parties shall be entitled to withdraw from the contract with respect to the affected scope of the performance. Other claims are excluded.

3. Price, terms of payment

- (1) All prices are fixed prices plus statutory VAT. Unless otherwise agreed, our deliveries are ex works, excluding packaging, transport insurance, freight and installation. They are based on the wage and material costs and manufacturers costs and sales tax charges applicable at conclusion of the contract. If after the conclusion of the contract there should be changes in the calculation basis due to higher wage and material costs or manufacturing costs, sales tax charges, or due to other circumstances, in particular calculation changes for technical reasons, we shall be entitled to a price change in appropriate ratio to the changes occurring in the calculation basis. Alternatively, we are entitled to withdraw from the contract. This also applies to blank or call-off orders, unless expressly agreed otherwise in the contract.
- (2) The prices offered are binding and are payable net within 30 days after receipt of the delivery or provision of services. We grant 2% discount for complete payments effected within 10 calendar days.
- (3) In case of default, the Customer must pay interest on the debt at the rate of 8% above the base rate. We reserve the right to claim and provide evidence for higher amount of damage caused by the delay.
- (4) In the event of payment arrears and justified doubts as to the solvency or creditworthiness of the Customer we are entitled - without prejudice to our other rights - to demand securities or advance payments for outstanding deliveries, to send the goods by cash on delivery even if other payment terms have been agreed and to make all claims arising from the business relationship due immediately. Only undisputed or legally established claims entitle the Customer to offsetting or retention. The Customer may exercise a right of retention only if its counter-claim is based on the same contractual relationship.

4. Place of performance, shipping, assumption of risk, transfer of risk

- (1) Place of performance is our place of business.
- (2) If the goods are to be sent to a location other than the place of performance upon the request of the Customer, the Customer shall be separately billed for the cost of packaging and transport. The risk of accidental loss and accidental deterioration of the goods, in case of the purchase to destination, is transferred to the Customer upon the hand-over to the shipper, carrier or otherwise to the person or institution specified to perform the shipment. The hand-over shall be deemed to have taken place even if the Customer is in default of acceptance.

5. Guarantee

- (1) Buyer's right regarding material and legal defects (including wrong and short delivery as well as improper assembly or faulty assembly instructions) are governed by statutory provisions, unless specified otherwise hereinafter. Special statutory provisions shall in any case remain unaffected in case of final deliveries of goods to a consumer (Supplier recourse acc. §§ 478, 479 of the German Civil Code-BGB).
- (2) The basis for our defect liability is above all the agreements made regarding the quality of the goods. As regards the quality of the goods solely our product description shall be deemed as agreed, to the extent they are made subject of individual contracts.
- (3) If the quality has not been agreed to, it should be assessed in accordance with statutory regulations whether there is a defect or not (§ 434 paragraph 1 Sentence 1 and 3 BGB). We do not assume any liability with respect to public statements made by the manufacturer or other third parties (e.g. advertising statements).
- (4) Defect claims on the part of the Buyer require that it has met its statutory inspection and complaint obligations (§§ 377, 381 HGB). If a defect is detected during or after the inspection, we must be informed accordingly immediately in writing. The notification is deemed to have been made immediately when it is made within two weeks, whereby the timely despatch of the notification suffices. Regardless of this inspection and notification obligation the Buyer must report obvious defects (including wrong and short delivery) within two weeks after delivery, whereby the timely despatch of the notification is again considered sufficient. If the Buyer fails in performing proper inspection and/or report defects, our liability for defects not notified is excluded.
- (5) If the delivered items are defective we can first decide whether we provide subsequent performance by remedying the defect (repair) or by delivery of faultless item (replacement delivery). Our right to refuse subsequent performance pursuant to statutory requirements remains unaffected.
- (6) We are entitled to make owed subsequent performance depend on the Buyer paying the purchase price due. However, the Buyer is entitled to retain a reasonable portion of the purchase price in relation to the defect.
- (7) The Buyer has to provide us with the required time and opportunity for the due subsequent performance, in particular in order to hand over the rejected goods for verification purposes. In case of replacement delivery the Buyer must return the defective goods in accordance with statutory regulations. Subsequent performance entails neither the removal of the defective items, nor the installation, if we were not initially obligated for installation.
- (8) If the subsequent performance has failed, a reasonable grace period set by the Buyer has expired or is irrelevant under statutory regulations, the Buyer may withdraw from the purchase contract or reduce the purchase price. There is no right of withdrawal in case of an insignificant defect.
- (9) The Buyer may not assert claims for compensation or reimbursement for futile expenses in accordance with item 6 and are otherwise excluded.

6. Other liability

- (1) Unless stated otherwise in these General Terms and Conditions including the following provisions, we shall be liable for any breach of contractual non-tariff obligations in accordance with applicable statutory regulations.
- (2) We assume liability for compensation – irrespective of their legal grounds – in case of intent or gross negligence. In case of slight negligence we shall be liable only
 - a) for damages resulting from injury to life, body or health
 - b) for damages arising from breach of an essential contractual obligation (obligation, the fulfilment of which renders a correct execution of the contract and on whose compliance the Contractual Partner regularly relies and may rely); in this case, our liability shall be limited to compensation for the foreseeable, typically occurring damages.
- (3) The liability limitations implied by paragraph 2 shall not apply, if we have concealed a defect fraudulently or assumed responsibility for the quality of the goods. The same applies to the claims of the Buyer under the Product Liability Act.
- (4) The Buyer may withdraw or terminate due to a breach of obligation, which does not result from a defect, when we are responsible for the breach of obligation. A free right of termination of the Buyer (in particular according to §§ 651, 649 BGB) is excluded. Otherwise, the statutory requirements and legal consequences shall apply.

7. Retention of title

- (1) We reserve title to the goods until full settlement of all claims from ongoing business relationships with the Customer, hence until full payment for all of our claims including ancillary claims and claims for damages. Payment by check does not terminate the retention of title until the irrevocable value date.
- (2) The Customer is obligated to inform us immediately if a third party gains access to the goods, such as in the case of pledges or in case the goods are damaged or destroyed. The Buyer must inform us immediately in the event of change of ownership of the goods and its change of residence. The Customer shall inform us immediately in case of pledging and seizures or other dispositions by third parties. We must be immediately informed with all the information when we need a third-party interpleader in accordance with § 771 German Code of Civil Procedure (ZPO). The Customer shall be liable if we suffer losses because a third party cannot pay for the court or out of court costs of the action in accordance with § 771 ZPO to be reimbursed to us. The Customer may neither pledge nor assign the delivery item without our prior consent.
- (3) We are entitled to withdraw from the contract and reclaim the goods in the event that the Customer acts in breach of contract, in particular in case of default of payment or breach of an obligation under paragraph 3 and 4 of this provision.
- (4) If we authorise the Customer to resell the goods in the ordinary course of business, the Customer hereby assigns to us all claims in the amount of the invoice which arise against third parties from the resale. We herein accept the assignment. The Customer shall be authorised to collect the claim after the assignment. However, we reserve the right to collect the claim ourselves as soon the Customer does not meet its payment obligations and falls into arrears.
- (5) The handling and processing of goods by the Customer is always carried out in our name and on our behalf. If the processing is carried out with items not belonging to us, we shall acquire co-ownership of the new goods in proportion of the value of the goods delivered to us to the other processed objects. The same applies if the goods are mixed with other objects not belonging to us.
- (6) The Customer shall insure the reserved goods adequately, in particular against fire and theft.

8. Period of limitation

- (1) Notwithstanding § 438 paragraph 1 No. 3 BGB, the general period of limitation for claims for material and legal defects is one year from the delivery. If acceptance has been agreed, the period of limitation begins with the acceptance.
- (2) The foregoing period of limitation for the right to purchase shall also apply to contractual and non-contractual claims for damages by the Buyer which are based on a defect in the goods, unless the application of the regular statutory period of limitation (§§ 195, 199 BGB) would result in a shorter period of limitation in individual cases. The periods of limitation of the product liability law remain unaffected in any event. Otherwise, the statutory periods of limitation shall exclusively apply for claims for damages of the Buyer in accordance with paragraph 6.

9. Miscellaneous

The invalidity of one of the clauses of these Terms shall not affect the remaining provisions. In such cases, one of the regulations which economically come closest to the invalid clause shall apply; alternatively the provisions of BGB are applicable.

10. Applicable law and jurisdiction

- (1) These General Terms and Conditions as well as all legal relations between us and the Buyer are governed by the Law of the Federal Republic of Germany, in exclusion of the international uniform law, in particular the UN Sales Convention. The prerequisites for and the effects of retention of title in accordance with item 7 shall be governed by the law in force at the place where the items are stored, if a choice of law made in favour of German law is inadmissible or ineffective.
- (2) If the Buyer is a merchant within the meaning of the German Commercial Code, a legal entity under public law or special fund under public law, our registered office in Bad Urach shall be the exclusive place of jurisdiction – including internationally – for all disputes arising directly or indirectly in connection with this contractual relationship. However, we are also entitled to file action in the general jurisdiction of the Buyer.



